



PROFESSIONAL DIGITAL TWO-WAY RADIO

MOTOTRBO™

**CM7668/CM7668i, XiR M8660/XiR M8660i,
XiR M8668/XiR M8668i**

ALPHANUMERIC DISPLAY MOBILE RADIO

USER GUIDE

en-US

zh-CN

ja-JP

ko-KR

id-ID



APRIL 2019

© 2019 Motorola Solutions, Inc. All rights reserved.



MN003675A01-AE

This is to declare that MSI products comply with the EU Directive 2011/65/EU (Restriction of Hazardous Substance or RoHS-2) and India RoHS, including applicable exemptions, with respect to the following substances:

Lead (Pb) < 0.1% by weight (1000 ppm)

Mercury (Hg) < 0.1% by weight (1000 ppm)

Cadmium (Cd) < 0.01% by weight (100 ppm)

Hexavalent Chromium (Cr6+) < 0.1% by weight (1000 ppm)

Polybrominated Biphenyls (PBB) < 0.1% by weight (1000 ppm)

Polybrominated Diphenyl Ethers (PBDE) < 0.1% by weight (1000 ppm)

Contents

Important Safety Information.....	27	Receiving and Responding to WAVE Group Calls.....	40
Software Version.....	28	Receiving and Responding to WAVE Private Calls.....	41
Copyrights.....	29	Switching from WAVE Mode to Radio Mode	41
Computer Software Copyrights.....	31	WAVE Tactical/5000.....	42
Handling Precautions.....	32	Setting Active WAVE Channels	42
Chapter 1: Basic Operations.....	33	Viewing WAVE Channel Information.....	42
Powering Up the Radio.....	33	Viewing WAVE Endpoints Information....	42
Powering Off the Radio.....	33	Changing WAVE Configuration.....	43
Adjusting the Volume.....	33	Making WAVE Group Calls.....	44
Chapter 2: Radio Controls.....	35	Part I: Capacity Max Operations.....	45
Volume/Channel Knob.....	35	Push-To-Talk (PTT) Button.....	45
Setting Dual Knob Operation Preference.....	36	Programmable Buttons.....	45
Keypad Microphone Buttons.....	37	Assignable Radio Functions.....	46
Chapter 3: WAVE.....	39	Assignable Settings or Utility Functions.....	48
WAVE OnCloud/OnPremise.....	39	Accessing Programmed Functions.....	48
Switching from Radio Mode to WAVE Mode.....	39	Status Indicators.....	49
Making WAVE Group Calls.....	40	Icons.....	49
		LED Indicator.....	55
		Tones.....	56

Audio Tones.....	56	Making Group Calls by Using the Alias Search	65
Indicator Tones.....	56	Responding to Group Calls.....	68
Registration.....	57	Broadcast Call.....	69
Zone and Channel Selections.....	58	Making Broadcast Calls.....	69
Selecting Zones	58	Making Broadcast Calls Using the Contact List.....	69
Selecting Zones by Using the Alias Search.....	59	Making Broadcast Calls Using the Programmable Number Key..	70
Selecting a Call Type.....	59	Receiving Broadcast Calls.....	71
Selecting a Site.....	60	Private Call.....	71
Roam Request.....	60	Making Private Calls.....	72
Site Lock On/Off.....	60	Making Private Calls by Using the Programmable Number Key	72
Site Restriction.....	61	Making Private Calls by Using the Alias Search	73
Site Trunking	61	Making a Private Call with a One Touch Call Button	75
Calls.....	62	Making Private Calls by Using the Manual Dial	76
Group Calls.....	63	Receiving Private Calls.....	77
Making Group Calls.....	63	Accepting Private Calls.....	77
Making Group Calls by Using the Contacts List.....	64		
Making Group Calls by Using the Programmable Number Key	65		

Declining Private Calls.....	78	Responding to Phone Calls as Group Calls.....	93
All Calls.....	78	Responding to Phone Calls as Private Calls.....	94
Making All Calls.....	78	Call Preemption.....	94
Making All Calls by Using the Programmable Number Key	79	Voice Interrupt.....	95
Making All Calls by Using the Alias Search.....	80	Enabling Voice Interrupt.....	95
Receiving All Calls.....	81	Advanced Features.....	96
Phone Calls.....	82	Call Queue.....	96
Making Phone Calls.....	82	Priority Call.....	96
Making Phone Calls with the Programmable Button 	83	Talkgroup Scan.....	97
Making Phone Calls by Using the Contacts List	85	Turning Talkgroup Scan On or Off.....	97
Making Phone Calls by Using the Alias Search.....	87	Receive Group List.....	98
Making Phone Calls by Using the Manual Dial.....	90	Priority Monitor.....	98
Dual Tone Multi Frequency.....	92	Editing Priority for a Talkgroup.....	99
Initiating DTMF Calls.....	92	Multi-Talkgroup Affiliation.....	100
Responding to Phone Calls as All Calls.....	93	Adding Talkgroup Affiliation.....	100
		Removing Talkgroup Affiliation..	101
		Talkback.....	102
		Bluetooth.....	102
		Turning Bluetooth On and Off....	103

Connecting to Bluetooth Devices.....	104	Muting the Home Channel Reminder.....	111
Connecting to Bluetooth Devices in Discoverable Mode...	105	Setting New Home Channels.....	111
Disconnecting from Bluetooth Devices.....	105	Remote Monitor.....	112
Switching Audio Route between Internal Radio Speaker and Bluetooth Device.....	106	Initiating Remote Monitor.....	112
Viewing Device Details.....	106	Initiating Remote Monitor by Using the Contacts List	113
Deleting Device Name.....	107	Initiating Remote Monitors by Using the Manual Dial.....	114
Bluetooth Mic Gain.....	107	Contacts Settings.....	115
Indoor Location.....	108	Assigning Entries to Programmable Number Keys.....	116
Turning Indoor Location On or Off.....	108	Removing Associations Between Entries and Programmable Number Keys.....	117
Accessing Indoor Location Beacons Information.....	109	Adding New Contacts	117
Multi-Site Controls.....	110	Call Indicator Settings.....	118
Starting Manual Site Search.....	110	Activating or Deactivating Call Ringers for Private Calls.....	118
Site Lock On/Off.....	110	Activating or Deactivating Call Ringers for Text Messages	119
Accessing Neighbor Sites List...	111	Activating or Deactivating Call Ringers for Call Alerts.....	120
Home Channel Reminder.....	111		

Activating or Deactivating Call Ringers for Selective Calls.....	120	Setting Mute Mode Timer.....	128
Activating or Deactivating Call Ringers for Telemetry Status with Text.....	121	Exiting Mute Mode.....	129
Assigning Ring Styles.....	121	Emergency Operation.....	130
Escalating Alarm Tone Volume..	122	Sending Emergency Alarms.....	131
Call Log Features.....	122	Sending Emergency Alarms with Call.....	132
Viewing Recent Calls.....	123	Sending Emergency Alarms with Voice to Follow.....	133
Storing Aliases or IDs from the Call List.....	123	Receiving Emergency Alarms ...	135
Deleting Calls from the Call List.	124	Responding to Emergency Alarms	136
Deleting All Calls from the Call List	124	Responding to Emergency Alarms with Call.....	136
Viewing Details from the Call List.....	125	Status Message.....	137
Call Alert Operation.....	126	Sending Status Messages.....	138
Making Call Alerts.....	126	Sending Status Message by Using Programmable Button.....	138
Making Call Alerts by Using the Contacts List.....	127	Sending a Status Message by Using the Contacts List.....	139
Responding to Call Alerts	127	Sending Status Message by Using Manual Dial.....	140
Mute Mode.....	128	Viewing Status Messages.....	141
Turning On Mute Mode.....	128		

- Responding to Status Messages 141
- Deleting a Status Message..... 142
- Deleting All Status Messages ... 143
- Text Messaging..... 143
 - Text Messages..... 143
 - Viewing Text Messages . 144
 - Viewing Telemetry Status Text Messages..... 144
 - Responding to Text Messages..... 145
 - Responding to Text Messages with Quick Text..... 145
 - Resending Text Messages 146
 - Forwarding Text Messages..... 147
 - Forwarding Text Messages by Using the Manual Dial..... 147
 - Editing Text Messages.... 148
 - Writing Text Messages.... 149

- Sending Text Messages.. 150
- Deleting Text Messages from the Inbox..... 150
- Deleting All Text Messages from the Inbox 151
- Sent Text Messages..... 152
 - Viewing Sent Text Messages..... 152
 - Sending Sent Text Messages..... 153
 - Deleting Sent Text Messages from the Sent Items Folder..... 154
 - Deleting All Sent Text Messages from the Sent Items Folder 154
- Saved Text Messages..... 155
 - Viewing Saved Text Messages..... 155
 - Editing Saved Text Messages..... 155
 - Deleting Saved Text Messages from the Drafts Folder..... 156

Quick Text Messages	157	Sending Job Tickets Using More Than One Job Ticket Template..	168
Sending Quick Text Messages	157	Deleting Job Tickets.....	169
Text Entry Configuration.....	158	Deleting All Job Tickets.....	170
Enabling or Disabling Word Correct.....	158	Privacy.....	170
Enabling or Disabling Word Predict.....	159	Turning Privacy On or Off.....	171
Sentence Cap.....	160	Response Inhibit.....	172
Viewing Custom Words.....	160	Turning Response Inhibit On or Off.....	172
Editing Custom Words.....	161	Stun/Revive.....	172
Adding Custom Words.....	162	Stunning a Radio.....	173
Deleting a Custom Word.....	163	Stunning a Radio by Using the Contacts List	173
Deleting All Custom Words.....	164	Stunning a Radio by Using the Manual Dial.....	174
Job Tickets.....	164	Reviving a Radio.....	175
Accessing the Job Ticket Folder	165	Reviving a Radio by Using the Contacts List.....	176
Logging In or Out of the Remote Server.....	166	Reviving a Radio by Using the Manual Dial.....	176
Creating Job Tickets.....	166	Radio Kill.....	177
Responding to Job Tickets.....	167	Lone Worker.....	178
Sending Job Tickets Using One Job Ticket Template.....	168	Password Lock Features.....	178

Accessing Radios by Using Passwords.....	178	Designated Radio (Individual Control).....	186
Unlocking Radios in Locked State.....	179	Turning Wi-Fi On or Off Remotely by Using a Designated Radio (Group Control).....	186
Turning Password Lock On or Off.....	179	Connecting to a Network Access Point.....	187
Changing Passwords.....	180	Checking Wi-Fi Connection Status	188
Notification List	181	Refreshing the Network List.....	189
Accessing Notification List	181	Adding a Network.....	189
Over-the-Air Programming	182	Viewing Details of Network Access Points.....	190
Selecting Third-Party Peripherals Connection Modes.....	182	Removing Network Access Points.....	191
Received Signal Strength Indicator.....	183	Dynamic Group Number Assignment (DGNA).....	191
Viewing RSSI Values.....	183	Making DGNA Calls.....	192
Front Panel Configuration.....	183	Making Non-DGNA Calls.....	192
Entering Front Panel Configuration Mode.....	184	Receiving and Responding to DGNA Calls.....	193
Editing FPP Mode Parameters..	184	Utilities.....	193
Wi-Fi Operation.....	184		
Turning Wi-Fi On or Off.....	185		
Turning Wi-Fi On or Off Remotely by Using a			

Power Levels.....	193	Turning Option Board On or Off.....	204
Setting Power Levels.....	194	Text-to-Speech.....	204
Turning Radio Tones/Alerts On or Off..	194	Setting Text-to-Speech.....	205
Turning Keypad Tones On or Off.....	195	Setting Menu Timer.....	205
Setting Tones/Alerts Volume Offset		Turning Digital Microphone AGC On or	
Levels.....	196	Off	206
Turning Talk Permit Tone On or Off....	196	Turning Intelligent Audio On or Off.....	206
Turning Power Up Tone On or Off.....	197	Turning the Acoustic Feedback	
Setting Text Message Alert Tones.....	198	Suppressor Feature On or Off.....	207
Changing Display Modes.....	198	Turning Trill Enhancement On or Off....	208
Adjusting Display Brightness.....	199	Audio Ambience.....	209
Turning Horns/Lights On or Off	199	Setting Audio Ambience.....	209
Turning LED Indicators On or Off.....	200	Audio Profiles.....	210
Turning Public Address System On or		Setting Audio Profiles.....	210
Off.....	201	Turning Global Navigation Satellite	
Turning External Public Address		System On or Off.....	211
System On or Off.....	201	General Radio Information	211
Turning Introduction Screen On or Off..	202	Checking Radio Alias and ID	212
Setting Languages.....	203	Checking Firmware and	
Identifying Cable Type.....	203	Codeplug Versions.....	212
Turning Voice Announcement On or		Checking Software Update	
Off	204	Information.....	213

Checking GNSS Information.....	213	Switching Between Connect Plus and Non-Connect Plus Modes.....	225
Displaying Site Information.....	214	Making and Receiving Calls in Connect Plus Mode.....	225
Viewing Enterprise Wi-Fi Certificate Details.....	214	Selecting a Site.....	225
Part II: Connect Plus Operations.....	216	Roam Request.....	226
Additional Radio Controls in Connect Plus Mode.....	216	Site Lock On/Off.....	226
Push-To-Talk (PTT) Button.....	216	Site Restriction.....	226
Programmable Buttons.....	216	Selecting a Zone.....	227
Assignable Radio Functions.....	216	Using Multiple Networks.....	228
Assignable Settings or Utility Functions.....	218	Selecting a Call Type.....	228
Identifying Status Indicators in Connect Plus Mode.....	219	Receiving and Responding to a Radio Call.....	228
Display Icons.....	219	Receiving and Responding to a Group Call.....	229
Call Icons.....	221	Receiving and Responding to a Private Call.....	229
Advanced Menu Icons.....	222	Receiving a Site All Call.....	230
Sent Item Icons.....	223	Receiving an Inbound Private Phone Call.....	231
Bluetooth Device Icons.....	223	Making a Buffered Over- Dial in an Inbound Phone Private Call.....	231
LED Indicator.....	224		
Indicator Tones.....	224		
Alert Tones.....	225		







Making a Live Over-Dial in an Inbound Phone Private Call.....	232	Making an Outbound Private Phone Call via the Phone Menu	238
Receiving an Inbound Phone Talkgroup Call.....	232	Making an Outbound Private Phone Call from Contacts.....	238
Inbound Phone Multi-Group Call	232	Waiting for the Channel Grant in an Outbound Private Phone Call	240
Making a Radio Call.....	232	Making a Buffered Over-Dial in a Connected Outbound Private Phone Call.....	240
Making a Call with the Channel Selector Knob.....	233	Making a Live Over-Dial in a Connected Outbound Private Phone Call.....	241
Making a Group Call.....	233	Advanced Features in Connect Plus Mode.....	241
Making a Private Call.....	234	Home Channel Reminder.....	241
Making a Site All Call.....	234	Auto Fallback.....	242
Making a Multi-group Call	235	Indications of Auto Fallback Mode.....	242
Making a Private Call with a One Touch Call Button.....	235	Making/Receiving Calls in Fallback Mode.....	243
Making a Call with the Programmable Manual Dial Button.....	236	Returning to Normal Operation..	243
Making a Private Call.....	236	Radio Check.....	244
Making an Outbound Private Phone Call with the Programmable Manual Dial Button.....	237	Sending a Radio Check.....	244



















Remote Monitor.....	245	Activating and Deactivating Call Ringers for Private Calls.....	258
Initiating Remote Monitor.....	245	Activating and Deactivating Call Ringers for Text Message.....	258
Scan.....	246	Selecting a Ring Alert Type.....	259
Starting and Stopping Scan.....	246	Escalating Alarm Tone Volume..	259
Responding to a Transmission During a Scan.....	247	Call Log.....	260
User Configurable Scan.....	247	Viewing Recent Calls.....	260
Turning Scan On or Off.....	248	Deleting a Call from a Call List..	260
Editing the Scan List.....	249	Viewing Details from a Call List.	261
Add or Delete a Group via the Add Members Menu.....	250	Call Alert Operation.....	261
Understanding Scan Operation.....	252	Responding to Call Alerts	262
Scan Talkback.....	253	Making a Call Alert from the Contact List.....	262
Editing Priority for a Talkgroup.....	253	Making a Call Alert with the One Touch Access Button.....	263
Contacts Settings.....	254	Mute Mode.....	263
Making a Private Call from Contacts.....	255	Turning On Mute Mode.....	264
Making a Call Alias Search.....	255	Setting Mute Mode Timer.....	264
Adding a New Contact.....	256	Exiting Mute Mode.....	265
Call Indicator Settings.....	257	Emergency Operation.....	265
Activating and Deactivating Call Ringers for Call Alert.....	257		







Receiving an Incoming Emergency.....	267	Editing and Sending a Saved Text Message.....	274
Saving the Emergency Details to the Alarm List.....	267	Deleting a Saved Text Message from Drafts.....	275
Deleting the Emergency Details.	268	Managing Fail-to-Send Text Messages.....	276
Responding to an Emergency Call.....	268	Resending a Text Message.....	276
Responding to an Emergency Alert.....	269	Forwarding a Text Message.....	276
Ignore Emergency Revert Call...	269	Managing Sent Text Messages.	277
Initiating an Emergency Call.....	270	Viewing a Sent Text Message.....	277
Initiating an Emergency Call with Voice to Follow.....	270	Sending a Sent Text Message.....	278
Initiating an Emergency Alert.....	271	Deleting All Sent Text Messages from Sent Items.....	279
Exiting Emergency Mode.....	271	Receiving a Text Message.....	280
Text Messaging.....	272	Reading a Text Message.....	280
Sending a Quick Text Message.	272	Managing Received Text Messages.....	280
Sending a Quick Text Message with the One Touch Access Button.....	273	Viewing a Text Message from the Inbox.....	281
Accessing the Drafts Folder.....	273		
Viewing a Saved Text Message.....	273		











Replying to a Text Message from the Inbox..281	Switching Audio Route between Internal Radio Speaker and Bluetooth Device.....292
Deleting a Text Message from the Inbox..... 282	Viewing Device Details..... 292
Deleting All Text Messages from the Inbox283	Deleting Device Name..... 293
Privacy..... 284	Bluetooth Mic Gain.....293
Making a Privacy-Enabled (Scrambled) Call..... 285	Indoor Location..... 294
Security.....285	Turning Indoor Location On or Off..... 294
Radio Disable.....285	Accessing Indoor Location Beacons Information..... 295
Radio Enable..... 287	Notification List..... 296
Bluetooth Operation.....289	Accessing the Notification List... 296
Turning Bluetooth On and Off.... 289	Wi-Fi Operation.....296
Finding and Connecting to a Bluetooth Device.....290	Turning Wi-Fi On or Off.....297
Finding and Connecting from a Bluetooth Device (Discoverable Mode).....291	Turning Wi-Fi On or Off Remotely by Using a Designated Radio (Individual Control)..... 298
Disconnecting from a Bluetooth Device..... 291	Turning Wi-Fi On or Off Remotely by Using a Designated Radio (Group Control)..... 299







Connecting to a Network Access Point.....	299	Turning the Introduction Screen On or Off.....	309
Checking Wi-Fi Connection Status	300	Language.....	310
Refreshing the Network List.....	301	Turning the LED Indicator On or Off.....	310
Adding a Network.....	302	Identifying Cable Type.....	311
Viewing Details of Network Access Points.....	302	Voice Announcement.....	311
Removing Network Access Points.....	303	Menu Timer.....	312
Utilities.....	304	Turning Horns/Lights On or Off..	312
Turning the Radio Tones/Alerts On or Off.....	304	Setting Dual Knob Operation Preference.....	313
Setting the Tone Alert Volume Offset Level.....	305	Digital Mic AGC (Mic AGC-D)....	313
Turning the Talk Permit Tone On or Off.....	305	Intelligent Audio.....	314
Turning the Power Up Alert Tone On or Off.....	306	Turning the Acoustic Feedback Suppressor Feature On or Off...	315
Setting the Power Level.....	307	Turning GNSS On or Off.....	316
Changing the Display Mode.....	308	Accessing General Radio Information.....	317
Adjusting the Display Brightness	308	Checking the Radio Model Number Index.....	317
		Checking the CRC of the Option Board OTA Codeplug File.....	318

Displaying the Site ID (Site Number).....	318	Conventional Analog and Digital Modes.....	342
Checking the Site Info.....	319	Icon Information.....	343
Checking the Radio ID....	319	IP Site Connect 	343
Checking the Firmware Version and Codeplug Version.....	320	Capacity Plus–Single-Site 	344
Checking for Updates.....	321	Capacity Plus–Multi-Site 	344
Viewing Enterprise Wi-Fi Certificate Details.....	328	Zone and Channel Selections.....	345
Part III: Other Systems.....	329	Selecting Zones	345
Push-To-Talk Button	329	Selecting Zones by Using the Alias Search.....	346
Programmable Buttons.....	329	Selecting Channels.....	346
Assignable Radio Functions.....	329	Calls.....	347
Assignable Settings or Utility Functions	332	Group Calls.....	348
Accessing Programmed Functions.....	333	Making Group Calls.....	348
Status Indicators.....	334	Making Group Calls by Using the Contacts List	349
Icons.....	334	Making Group Calls by Using the Programmable Number Key  	349
LED Indicators	340	Responding to Group Calls.....	350
Tones.....	341	Private Calls 	351
Indicator Tones.....	342	Making Private Calls 	351
Audio Tones.....	342		











Making Private Calls by Using the Contacts List 	352	Making Phone Calls by Using the Manual Dial 	363
Making Private Calls by Using the Manual Dial 	353	Making Group, Private, Phone or All Calls by Using the Alias Search  	365
Making Private Calls by Using the Programmable Number Key  	354	Dual Tone Multi Frequency.....	367
Responding to Private Calls  .	354	Initiating DTMF Calls.....	367
All Calls.....	355	Responding to Phone Calls as Group Calls 	368
Receiving All Calls.....	355	Responding to Phone Calls as All Calls 	368
Making All Calls.....	356	Responding to Phone Calls as Private Calls 	369
Making All Calls by Using the Programmable Number Key  .	356	Stopping Radio Calls 	369
Selective Calls 	357	Talkaround.....	370
Making Selective Calls.....	357	Toggling Between Repeater and Talkaround Modes.....	370
Responding to Selective Calls 	358	Broadcast Voice Calls.....	371
Phone Calls 	358	Making Broadcast Voice Calls...	371
Making Phone Calls 	359	Making Broadcast Voice Calls by Using the Programmable Number Key 	372
Making Phone Calls by Using the Contacts List 	360		

Making Broadcast Voice Calls by Using the Alias Search  372	Initiating Remote Monitor by Using the Contacts List 382
Receiving Broadcast Voice Calls 374	Initiating Remote Monitor by Using the Manual Dial  383
Unaddressed Calls..... 374	Scan Lists..... 384
Making Unaddressed Calls..... 375	Viewing Entries in the Scan List 385
Responding to Unaddressed Calls..... 375	Viewing Entries in the Scan List by Using the Alias Search 385
Open Voice Channel Mode (OVCM).... 376	Adding New Entries to the Scan List..... 386
Making OVCM Calls..... 376	Adding New Entries to the Scan List by Using the Alias Search 
Responding to OVCM Calls..... 377 387
Advanced Features..... 377	Deleting Entries from the Scan List..... 388
Home Channel Reminder..... 377	Setting Priority for Entries in the Scan List..... 388
Muting the Home Channel Reminder..... 378	Scan..... 389
Setting New Home Channels..... 378	Turning Scan On or Off 390
Radio Check  379	Responding to Transmissions During Scanning..... 390
Sending Radio Checks  379	Deleting Nuisance Channels..... 391
Sending Radio Checks by Using the Manual Dial  380	Restoring Nuisance Channels... 391
Remote Monitor..... 381	
Initiating Remote Monitor..... 381	

Vote Scan 	391	Activating or Deactivating Call Ringers for Text Messages 	... 399
Contacts Settings.....	392	Activating or Deactivating Call Ringers for Telemetry Status with Text.....	400
Making Group Calls by Using the Contacts List	392	Assigning Ring Styles.....	400
Making Private Calls by Using the Contacts List 	393	Escalating Alarm Tone Volume..	401
Assigning Entries to Programmable Number Keys 	394	Call Log Features.....	401
Removing Associations Between Entries and Programmable Number Keys 	395	Viewing Recent Calls.....	402
Adding New Contacts	396	Deleting Calls from the Call List 	402
Setting Default Contact 	396	Viewing Call List Details 	403
Call Indicator Settings.....	397	Storing Aliases or IDs from the Call List 	403
Activating or Deactivating Call Ringers for Call Alerts.....	397	Call Alert Operation	404
Activating or Deactivating Call Ringers for Private Calls 	398	Making Call Alerts.....	404
Activating or Deactivating Call Ringers for Selective Calls 	398	Making Call Alerts by Using the Contacts List.....	404
		Making Call Alerts by Using the Manual Dial.....	405
		Responding to Call Alerts	406
		Mute Mode.....	406

Turning On Mute Mode.....	407	Viewing Text Messages .	416
Setting Mute Mode Timer.....	407	Viewing Telemetry Status	
Exiting Mute Mode.....	408	Text Messages.....	417
Emergency Operation	408	Responding to Text	
Receiving Emergency Alarms....	409	Messages 	417
Responding to Emergency		Responding to Text	
Alarms.....	410	Messages with Quick	
Exiting Emergency Mode After		Text 	418
Receiving the Emergency Alarm	411	Resending Text	
Sending Emergency Alarms	411	Messages	419
Sending Emergency Alarms with		Forwarding Text	
Call	412	Messages 	420
Emergency Alarms with Voice to		Forwarding Text	
Follow	413	Messages by Using the	
Sending Emergency Alarms with		Manual Dial 	420
Voice to Follow 	414	Editing Text Messages....	421
Reinitiating Emergency Mode....	414	Writing Text Messages....	422
Exiting Emergency Mode After		Sending Text Messages..	422
Sending the Emergency Alarm..	415	Deleting Text Messages	
Deleting an Alarm Item from the		from the Inbox.....	423
Alarm List.....	415	Deleting All Text	
Text Messaging.....	416	Messages from the Inbox	
Text Messages 	416		424

Sent Text Messages 	425	Enabling or Disabling Word Correct.....	431
Viewing Sent Text Messages 	425	Enabling or Disabling Word Predict.....	432
Sending Sent Text Messages 	426	Sentence Cap.....	433
Deleting Sent Text Messages from the Sent Items Folder 	427	Viewing Custom Words.....	433
Deleting All Sent Text Messages from the Sent Items Folder	427	Editing Custom Words.....	434
Saved Text Messages.....	428	Adding Custom Words.....	435
Viewing Saved Text Messages.....	428	Deleting a Custom Word.....	436
Editing Saved Text Messages.....	428	Deleting All Custom Words.....	437
Deleting Saved Text Messages from the Drafts Folder.....	429	Job Tickets.....	437
Quick Text Messages 	430	Accessing the Job Ticket Folder	438
Sending Quick Text Messages 	430	Logging In or Out of the Remote Server.....	439
Text Entry Configuration.....	431	Creating Job Tickets.....	439
		Responding to Job Tickets.....	440
		Sending Job Tickets Using One Job Ticket Template.....	441
		Sending Job Tickets Using More Than One Job Ticket Template..	441
		Deleting Job Tickets.....	442
		Deleting All Job Tickets.....	443

Privacy 	443	Turning Bluetooth On and Off....	454
Turning Privacy On or Off 	444	Connecting to Bluetooth Devices.....	455
Response Inhibit.....	445	Connecting to Bluetooth Devices in Discoverable Mode...	456
Turning Response Inhibit On or Off.....	445	Disconnecting from Bluetooth Devices.....	457
Multi-Site Controls.....	446	Switching Audio Route between Internal Radio Speaker and Bluetooth Device.....	458
Starting Manual Site Search.....	446	Viewing Device Details.....	458
Site Lock On/Off.....	446	Deleting Device Name.....	458
Accessing Neighbor Sites List...	447	Bluetooth Mic Gain.....	459
Security 	447	Indoor Location.....	459
Disabling Radios 	447	Turning Indoor Location On or Off.....	460
Disabling Radios by Using the Contacts List 	448	Accessing Indoor Location Beacons Information.....	461
Disabling Radios by Using the Manual Dial 	449	Notification List	461
Enabling Radios 	450	Accessing Notification List	462
Enabling Radios by Using the Contacts List 	451	Auto-Range Transponder System 	462
Enabling Radios by Using the Manual Dial 	452	Over-the-Air Programming 	463
Lone Worker.....	453	Transmit Inhibit.....	463
Bluetooth.....	454		

Enabling Transmit Inhibit.....	463	Designated Radio (Individual Control).....	470
Disabling Transmit Inhibit.....	464	Turning Wi-Fi On or Off Remotely by Using a Designated Radio (Group Control).....	471
Selecting Third-Party Peripherals Connection Modes.....	464	Connecting to a Network Access Point.....	471
Received Signal Strength Indicator.....	465	Checking Wi-Fi Connection Status	472
Viewing RSSI Values.....	465	Refreshing the Network List.....	473
Password Lock Features.....	465	Adding a Network.....	474
Accessing Radios by Using Passwords.....	465	Viewing Details of Network Access Points.....	474
Unlocking Radios in Locked State.....	466	Removing Network Access Points.....	475
Turning Password Lock On or Off.....	466	Utilities.....	476
Changing Passwords.....	467	Squelch Levels	476
Front Panel Configuration.....	468	Setting Squelch Levels	476
Entering Front Panel Configuration Mode.....	468	Power Levels.....	477
Editing FPP Mode Parameters..	468	Setting Power Levels.....	477
Wi-Fi Operation.....	469	Turning Radio Tones/Alerts On or Off..	478
Turning Wi-Fi On or Off.....	469	Turning Keypad Tones On or Off.....	479
Turning Wi-Fi On or Off Remotely by Using a			

Setting Tones/Alerts Volume Offset Levels.....	479	Text-to-Speech.....	489
Turning Talk Permit Tone On or Off.....	480	Setting Text-to-Speech.....	489
Turning Power Up Tone On or Off.....	481	Turning Automatic Call Forwarding On or Off.....	490
Setting Text Message Alert Tones.....	481	Setting Menu Timer.....	491
Changing Display Modes.....	482	Turning Analog Microphone AGC On or Off	491
Adjusting Display Brightness.....	483	Turning Digital Microphone AGC On or Off	492
Turning Horns/Lights On or Off	483	Turning Intelligent Audio On or Off.....	493
Turning LED Indicators On or Off.....	484	Turning the Acoustic Feedback Suppressor Feature On or Off.....	493
Turning Public Address System On or Off.....	484	Turning Trill Enhancement On or Off....	494
Turning External Public Address System On or Off.....	485	Audio Ambience.....	495
Turning Introduction Screen On or Off..	486	Setting Audio Ambience.....	495
Setting Languages.....	486	Audio Profiles.....	496
Identifying Cable Type.....	487	Setting Audio Profiles.....	496
Voice Operating Transmission	487	Turning Global Navigation Satellite System On or Off.....	497
Turning Voice Operating Transmission On or Off.....	488	Flexible Receive List 	497
Turning Voice Announcement On or Off	488	Turning Flexible Receive List On or Off.....	498
Turning Option Board On or Off.....	489		

General Radio Information	498
Checking Radio Alias and ID	498
Checking Firmware and Codeplug Versions.....	499
Checking Software Update Information.....	499
Checking GNSS Information.....	500
Displaying Site Information.....	501
Viewing Enterprise Wi-Fi Certificate Details.....	501
Part IV: Authorized Accessories List.....	502

Important Safety Information

RF Energy Exposure and Product Safety Guide for Mobile Two-Way Radios

ATTENTION!

This radio is restricted to Occupational use only. Before using the radio, read the RF Energy Exposure and Product Safety Guide for Mobile Two-Way Radios which contains important operating instructions for safe usage and RF energy awareness and control for Compliance with applicable standards and Regulations.

For a list of Motorola Solutions-approved antennas and other accessories, visit the following website:

<http://www.motorolasolutions.com>

For models that are available in Thailand:

อุปกรณ์โทรคมนาคมนี้ได้ปฏิบัติตามข้อกำหนดของคณะกรรมการกิจการโทรคมนาคมแห่งชาติ

This telecommunication equipment conforms to the requirements of the National Telecommunications Commission.

Software Version

All the features described in the following sections are supported by the software version **R02.10.00.0000** or later.

See [Checking Firmware and Codeplug Versions on page 212](#) to determine the software version of your radio.

Check with your dealer or system administrator for more information.

Copyrights

The Motorola Solutions products described in this document may include copyrighted Motorola Solutions computer programs. Laws in the United States and other countries preserve for Motorola Solutions certain exclusive rights for copyrighted computer programs. Accordingly, any copyrighted Motorola Solutions computer programs contained in the Motorola Solutions products described in this document may not be copied or reproduced in any manner without the express written permission of Motorola Solutions.

© 2019 Motorola Solutions, Inc. All Rights Reserved

No part of this document may be reproduced, transmitted, stored in a retrieval system, or translated into any language or computer language, in any form or by any means, without the prior written permission of Motorola Solutions, Inc.

Furthermore, the purchase of Motorola Solutions products shall not be deemed to grant either directly or by implication, estoppel or otherwise, any license under the copyrights, patents or patent applications of Motorola Solutions, except for the normal non-exclusive, royalty-free license to use that arises by operation of law in the sale of a product.

Disclaimer

Please note that certain features, facilities, and capabilities described in this document may not be applicable to or licensed for use on a specific system, or may be dependent upon the characteristics of a specific subscriber unit or configuration of certain parameters. Please refer to your Motorola Solutions contact for further information.

Trademarks

MOTOROLA, MOTO, MOTOROLA SOLUTIONS, and the Stylized M Logo are trademarks or registered trademarks of Motorola Trademark Holdings, LLC and are used under license. All other trademarks are the property of their respective owners.

European Union (EU) Waste of Electrical and Electronic Equipment (WEEE) directive



■ The European Union's WEEE directive requires that products sold into EU countries must have the crossed out trash bin label on the product (or the package in some cases).

As defined by the WEEE directive, this cross-out trash bin label means that customers and end-users in EU countries

should not dispose of electronic and electrical equipment or accessories in household waste.

Customers or end-users in EU countries should contact their local equipment supplier representative or service centre for information about the waste collection system in their country.

Computer Software Copyrights

The Motorola Solutions products described in this manual may include copyrighted Motorola Solutions computer programs stored in semiconductor memories or other media. Laws in the United States and other countries preserve for Motorola Solutions certain exclusive rights for copyrighted computer programs including, but not limited to, the exclusive right to copy or reproduce in any form the copyrighted computer program. Accordingly, any copyrighted Motorola Solutions computer programs contained in the Motorola Solutions products described in this manual may not be copied, reproduced, modified, reverse-engineered, or distributed in any manner without the express written permission of Motorola Solutions. Furthermore, the purchase of Motorola Solutions products shall not be deemed to grant either directly or by implication, estoppel, or otherwise, any license under the copyrights, patents or patent applications of Motorola Solutions, except for the normal non-exclusive license to use that arises by operation of law in the sale of a product.

The AMBE+2™ voice coding Technology embodied in this product is protected by intellectual property rights including

patent rights, copyrights and trade secrets of Digital Voice Systems, Inc.

This voice coding Technology is licensed solely for use within this Communications Equipment. The user of this Technology is explicitly prohibited from attempting to decompile, reverse engineer, or disassemble the Object Code, or in any other way convert the Object Code into a human-readable form.

U.S. Pat. Nos. #5,870,405, #5,826,222, #5,754,974, #5,701,390, #5,715,365, #5,649,050, #5,630,011, #5,581,656, #5,517,511, #5,491,772, #5,247,579, #5,226,084 and #5,195,166.

Handling Precautions

The MOTOTRBO Series Digital Portable radio meets IP67 specifications, allowing your radio to withstand adverse field conditions such as being submersed in water. This section describes some basic handling precautions.



CAUTION:

Do not disassemble your radio. This could damage radio seals and result in leak paths into the radio. Radio maintenance should only be done in service depot that is equipped to test and replace the seal on the radio.

- If your radio has been submersed in water, shake your radio well to remove any water that may be trapped inside the speaker grille and microphone port. Trapped water could cause decreased audio performance.
- If your radio's battery contact area has been exposed to water, clean and dry battery contacts on both your radio and the battery before attaching the battery to radio. The residual water could short-circuit the radio.
- If your radio has been submersed in a corrosive substance (for example, saltwater), rinse radio and battery in fresh water then dry radio and battery.
- To clean the exterior surfaces of your radio, use a diluted solution of mild dishwashing detergent and fresh water (for example, one teaspoon of detergent to one gallon of water).
- Never poke the vent (hole) located on the radio chassis below the battery contact. This vent allows for pressure equalization in the radio. Doing so may create a leak path into radio and your radio's submersibility may be lost.
- Never obstruct or cover the vent, even with a label.
- Ensure that no oily substances come in contact with the vent.
- Your radio with antenna attached properly is designed to be submersible to a maximum depth of 1 m (3.28 ft) and a maximum submersion time of 30 minutes. Exceeding either maximum limit or use without antenna may result in damage to your radio.
- When cleaning your radio, do not use a high pressure jet spray on radio as this will exceed the 1 m depth pressure and may cause water to leak into your radio.

Basic Operations

This chapter explains the operations to get you started on using the radio.

Powering Up the Radio

Follow the procedure to power up your radio.

Press the **On/Off** button.

If successful:

- A tone sounds.
- The green LED lights up.
- The display shows MOTOTRBO (TM), followed by a welcome message or image.
- The Home screen lights up.

If the Tones/Alerts function is disabled, there is no tone upon powering up.

Check your battery if your radio does not power up. Make sure that it is charged and properly attached. Contact your dealer if your radio still does not power up.

Powering Off the Radio

Follow the procedure to power off your radio.

Press and hold the **On/Off** button.

The radio may take up to seven seconds to completely turn off.

The display shows Powering Down.

Adjusting the Volume

Follow the procedure to change the volume level of your radio.

Do one of the following:

- Turn the **On/Off/Volume Control Knob** clockwise to increase the volume.
- Turn the **On/Off/Volume Control Knob** counterclockwise to decrease the volume.



NOTICE:

Your radio can be programmed to have a minimum volume offset where the volume level cannot be lowered past the programmed minimum volume. Check with your dealer or system administrator for more information.

Radio Controls

This chapter explains the buttons and functions to control the radio.

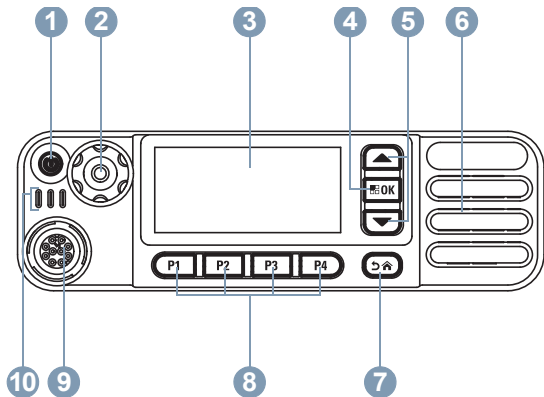

- 1 On/Off/Information Button
- 2 Volume/Channel Knob
- 3 Display
- 4 Menu/OK Button
- 5 Scroll Up/Down Buttons
- 6 Speaker



- 7 Return/Home Button
- 8 Front Programmable Buttons
- 9 Accessory Connector
- 10 LED Indicators

Volume/Channel Knob

The **Volume/Channel Knob** can be programmed for dual volume and channel control, or for volume control only.

To adjust the volume, see [Adjusting the Volume on page 33](#).



To change the channels, press and hold the **Volume/Channel Knob** until the channel selection state is displayed. Turn the **Volume/Channel Knob** to select the channel. Do one of the following to exit the channel selection state:



- Press the **Volume/Channel Knob**.
- Press .
- Press .
- Wait for the menu timer to expire.



Setting Dual Knob Operation Preference

Follow the procedure to set the dual knob operation preference of the radio.



- 1 Press  to access the menu.

- 2 Press  or  to Utilities. Press  to select.

- 3 Press  or  to Radio Settings. Press  to select.

- 4 Press  or  to Dual Knob. Press  to select.









The display shows Volume Only and Volume & Channel.







-
- 5 Press  or  to the required setting. Press  to select.

A ✓ appears beside the selected settings. The screen returns to the previous menu.

Keypad Microphone Buttons

You can use the 3 x 4 alphanumeric keypad on the 4-Way Navigation Keypad Microphone (Motorola Solutions part number RMN5127_) to access your radio features. Many characters require that you press a key multiple times. The table shows the number of times a key needs to be pressed to generate the required character.

Key	Number of Times Key is Pressed												
	1	2	3	4	5	6	7	8	9	10	11	12	13
	1	.	,	?	!	@	&	'	%	—	:	*	#
	A	B	C	2									
	D	E	F	3									
	G	H	I	4									
	J	K	L	5									
	M	N	O	6									
	P	Q	R	S	7								
	T	U	V	8									

Key	Number of Times Key is Pressed												
	1	2	3	4	5	6	7	8	9	10	11	12	13
	W	X	Y	Z	9								
	0		NOTICE: Press to enter "0" and long press to activate the CAPS lock. Another long press to turn off the CAPS lock.										
	* or del		NOTICE: Press during text entry to delete the character. Press during numeric entry to enter a "*" .										
	# or spac e		NOTICE: Press during text entry to insert a space. Press during numeric entry to enter a "#" .										

WAVE

Wide Area Voice Environment (WAVE™) provides a new method of making calls between two or more radios.

WAVE allows you to communicate across different networks and devices using Wi-Fi. WAVE calls are made when the radio is connected to an IP network through Wi-Fi.

Your radio supports different system configurations:

- WAVE OnCloud/OnPremise
- WAVE Tactical/5000

The method to initiate a WAVE Call is different for each system type. Refer to the appropriate section depending on the system configuration of your radio.

Table 1: WAVE Display Icons

The following icons appear momentarily on the display when WAVE is enabled.

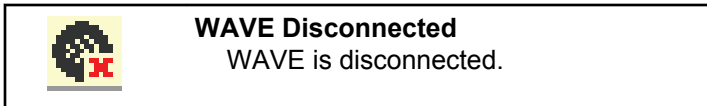
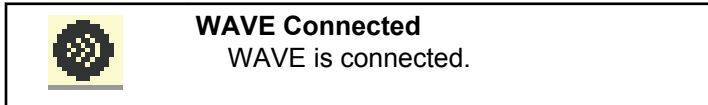





NOTICE:

This feature is applicable to specific models only.

WAVE OnCloud/OnPremise

Switching from Radio Mode to WAVE Mode

- 1 Do one of the following:
 - Press the programmed **WAVE** button. Skip the following steps.
 - Press  to access the menu.
-
- 2 Press  or  to WAVE. Press  to select.

The yellow LED double blinks.

The display shows a momentary notice of Switching to WAVE, then shows Preparing WAVE.



NOTICE:

Your radio automatically enables Wi-Fi after you switch to WAVE mode.

If successful:

- The blinking yellow LED turns off.
- The display shows the WAVE connected icon, <Talkgroup Alias>, and <Channel Index>.

If unsuccessful:

- A negative tone sounds.
- The red LED blinks.
- The display shows the WAVE disconnected icon and `No Connection or Activation: Fail`, depending on the error type.



NOTICE:

Synchronization occurs when new settings are updated to your radio. When you enter the WAVE mode, your radio displays `Syncing...`. When the synchronization completes, your radio returns to the home screen.

Making WAVE Group Calls

- 1 Select the WAVE talkgroup using the channel selector knob/buttons.

- 2 Press the **PTT** button to make the call.

If successful, the display shows the Group Call icon and the WAVE talkgroup alias.

If unsuccessful:

- A negative indicator tone sounds.
- The display shows a momentary notice of `Call Failed` or `No Participants`.

Receiving and Responding to WAVE Group Calls

When you receive a WAVE group call:

- A tone sounds.
- The display shows the group call icon, WAVE talkgroup alias, and caller alias.

- Your radio unmutes and the incoming call sounds through the speaker.

1 Press the **PTT** button to respond to the call.

2 Release the **PTT** button to listen.

Receiving and Responding to WAVE Private Calls

When you receive a WAVE private call:

- A tone sounds.
- The display shows the private call icon and caller alias.
- Your radio unmutes and the incoming call sounds through the speaker.



1 Press the **PTT** button to respond to the call.

2 Release the **PTT** button to listen.

Switching from WAVE Mode to Radio Mode

1 Do one of the following:

- Press the programmed **Radio Mode** button. Skip the following steps.
 - Press  **OK** to access the menu.
-

2 Press  or  to Radio Mode. Press  **OK** to select.

The yellow LED double blinks.

The display shows a momentary notice of Switching to Radio and then shows Preparing Radio.

When successful:

- The blinking yellow LED turns off.
- The WAVE connected icon disappears on the status bar. The display shows <Talkgroup Alias> and <Channel Index>.

WAVE Tactical/5000



Setting Active WAVE Channels









NOTICE:

WAVE channels are configured through CPS. Your radio automatically enables Wi-Fi and logs in to the WAVE server once you enter WAVE channel.

- 1 Press  to access the menu.

- 2 Press  or  to WAVE Channels. Press  to select.



- 3 Press  or  to the required WAVE channel. Press  to select.



- 4 Press  or  to Set As Active. Press  to select.



The display shows  beside the selected channel.

Viewing WAVE Channel Information

- 1 Do one of the following:
 - Press the programmed **WAVE Channel List** button. Skip the following steps.
 - Press  to access the menu.

- 2 Press  or  to WAVE Channels. Press  to select.

- 3 Press  or  to the required WAVE channel. Press  to select.



- 4 Press  or  to View Details. Press  to select.



The display shows the WAVE channel details.

Viewing WAVE Endpoints Information

- 1 Do one of the following:

- Press the programmed **Contact** button. Skip to [step 3](#).
- Press  to access the menu.

2 Press  or  to Endpoints. Press  to select.

3 Press  or  to the required WAVE Endpoint. Press  to select.



4 Press  to select View Details.



The display shows the WAVE Endpoint details.

Changing WAVE Configuration



Follow the procedure to set the WAVE server IP address, user ID, and password.



1 Press  to access the menu.



2 Press  or  to Utilities. Press  to select.



3 Press  or  to Radio Settings. Press  to select.

4 Press  or  to WAVE. Press  to select.

5 Press  to select Server Address. Press  to change the server address. Press  to select.

6 Press  to User ID. Press  to change the user ID. Press  to select.

7 Press  to Password. Press  to view or change the WAVE password. Press  to select.

- 8 Press  to Apply. Press  to apply all the changes made.
-

The display shows the positive mini notice momentarily before returning to the Radio Settings screen.

Making WAVE Group Calls

- 1 Select the WAVE channel with the required group alias or ID.
-
- 2 Press the **PTT** button to make the call.
- The green LED lights up. The first text line displays the **Group Call** icon and alias. The second text line displays the WAVE group alias.
-
- 3 Do one of the following:
- Wait for the Talk Permit Tone to end and speak clearly into the microphone if enabled.
 - Wait for the **PTT** Sidetone to end and speak clearly into the microphone if enabled
-

- 4 Release the **PTT** button to listen.

The green LED lights up when the target radio responds. The display shows the **Group Call** icon, and alias or ID, and the transmitting radio alias or ID.

- 5 If the Channel Free Indication feature is enabled, you hear a short alert tone the moment the transmitting radio releases the **PTT** button, indicating the channel is free for you to respond. Press the **PTT** button to respond to the call.

The call ends when there is no voice activity for a predetermined period. The radio returns to the screen you were on prior to initiating the call.

Capacity Max Operations

Capacity Max is a control channel-based trunked radio system. Features that are available to the radio users under this system are available in this chapter.

Push-To-Talk (PTT) Button

The **PTT** button serves two basic purposes.

- While a call is in progress, the **PTT** button allows the radio to transmit to other radios in the call. The microphone is activated when the **PTT** button is pressed.
- While a call is not in progress, the **PTT** button is used to make a new call.

Press and hold the **PTT** button to talk. Release the **PTT** button to listen.

If the Talk Permit Tone or the **PTT** Sidetone is enabled, wait until the short alert tone ends before talking.

If the Channel Free Indication feature is enabled on your radio (programmed by your dealer), you will hear a short alert tone the moment the target radio (the radio that is receiving your call) releases the **PTT** button, indicating the channel is free for you to respond.

You hear a continuous Talk Prohibit Tone if your call is interrupted, for example when the radio receives an Emergency call. You should release the **PTT** button.

Programmable Buttons

Depending on the duration of a button press, your dealer can program the programmable buttons as shortcuts to radio functions.

Short press

Pressing and releasing rapidly.

Long press

Pressing and holding for the programmed duration.



NOTICE:

See [Emergency Operation on page 408](#) for more information on the programmed duration of the **Emergency** button.

Assignable Radio Functions

The following radio functions can be assigned to the programmable buttons by your dealer or system administrator.

Audio Ambience

Allows the user to select an environment the radio is operating in.

Audio Profiles

Allows the user to select the preferred audio profile.

Bluetooth® Audio Switch

Toggles audio routing between internal radio speaker and external Bluetooth-enabled accessory.

Bluetooth Connect

Initiates a Bluetooth find-and-connect operation.

Bluetooth Disconnect

Terminates all existing Bluetooth connections between your radio and any Bluetooth-enabled devices.

Bluetooth Discoverable

Enables your radio to enter Bluetooth Discoverable Mode.

Contacts

Provides direct access to the Contacts list.

Call Alert

Provides direct access to the contacts list for you to select a contact to whom a Call Alert can be sent.

Call Log

Selects the call log list.

Emergency

Depending on the programming, initiates or cancels an emergency.

Ext Public Address (PA)

Toggles audio routing between the connected PA loudspeaker amplifier and the internal PA system of the radio.

Reset Home Channel

Sets a new home channel.

Silence Home Channel Reminder

Mutes the Home Channel Reminder.

Indoor Location

Toggles Indoor Location on or off.

Intelligent Audio

Toggles intelligent audio on or off.

Manual Dial

Initiates a Private Call by keying in any subscriber ID.

Manual Site Roam

Starts the manual site search.

Mic AGC

Toggles the internal microphone automatic gain control (AGC) on or off.

Notifications

Provides direct access to the Notifications list.

One Touch Access

Directly initiates a predefined Broadcast, Private, Phone or Group Call, a Call Alert, or a Quick Text message.

Option Board Feature

Toggles option board feature(s) on or off for option board-enabled channels.

Phone

Provides direct access to the Phone Contacts list.

Privacy

Toggles privacy on or off.

Public Address (PA)

Toggles the internal PA system of the radio on or off.

Radio Alias and ID

Provides radio alias and ID.

Remote Monitor

Turns on the microphone of a target radio without it giving any indicators.

Site Info

Displays the current Capacity Max site name and ID.

Plays site announcement voice messages for the current site when Voice Announcement is enabled.

Site Lock

When toggled on, the radio searches the current site only. When toggled off, the radio searches other sites in addition to the current site.

Telemetry Control

Controls the Output Pin on a local or remote radio.

Text Message

Selects the text message menu.

Toggle Call Priority Level

Enables your radio to enter Call Priority Level High/Normal.

Trill Enhancement

Toggles trill enhancement on or off.

Voice Announcement On/Off

Toggles voice announcement on or off.

Voice Announcement for Channel

Plays zone and channel announcement voice messages for the current channel. This function is unavailable when Voice Announcement is disabled.

Wi-Fi

Toggles Wi-Fi on or off.

Zone Selection

Allows selection from a list of zones.

Assignable Settings or Utility Functions

The following radio settings or utility functions can be assigned to the programmable buttons.

Tones/Alerts

Toggles all tones and alerts on or off.

Backlight

Toggles display backlight on or off.

Channel Up/Down

Depending on the programming, changes channel to previous or next channel.

Display Mode

Toggles the day/night display mode on or off.



Power Level



Toggles transmit power level between high and low.

Accessing Programmed Functions

Follow the procedure to access programmed functions in your radio.

- 1 Do one of the following:
 - Press the programmed button. Proceed to [step 3](#).
 - Press  to access the menu.

- 2 Press  or  to the menu function, and press  to select a function or enter a sub-menu.

- 3 Do one of the following:
 - Press  to return to the previous screen.
 - Long press  to return to the Home screen.Your radio automatically exits the menu after a period of inactivity and returns to the Home screen.

The Menu Navigation Buttons are also available on a keypad microphone. See [Keypad Microphone Buttons on page 37](#).

Status Indicators

This chapter explains the status indicators and audio tones used in the radio.

Icons

The Liquid Crystal Display (LCD) of your radio shows the radio status, text entries, and menu entries.







Table 2: Display Icons







The following icons appear on the status bar at the top of the radio display. The icons are arranged left most in order of appearance or usage, and are channel-specific.

	<p>BeiDou Only Available¹ BeiDou Only feature is enabled. The icon stays lit when a position fix is available.</p>
--	--









	<p>Bluetooth Connected The Bluetooth feature is enabled. The icon stays lit when a remote Bluetooth device is connected.</p>
	<p>Bluetooth Not Connected The Bluetooth feature is enabled but there is no remote Bluetooth device connected.</p>
	<p>DGNA Radio is in DGNA Talkgroup.</p>
	<p>Emergency Radio is in Emergency mode.</p>
	<p>GNSS Available GNSS feature is enabled. The icon stays lit when a position fix is available.</p>
	<p>GNSS Not Available GNSS feature is enabled but is not receiving data from the satellite.</p>

¹ Only applicable for XiR M8660i/XiR M8668i/CM7668i.

	<p>High Volume Data Radio is receiving high volume data and channel is busy.</p>
	<p>Indoor Location Available² Indoor location status is on and available.</p>
	<p>Indoor Location Unavailable² Indoor location status is on but unavailable due to Bluetooth disabled or Beacons Scan suspended by Bluetooth.</p>
	<p>Mute Mode Mute Mode is enabled and speaker is muted.</p>
	<p>Notification Notification List has one or more missed events.</p>
	<p>Option Board The Option Board is enabled. (Option board enabled models only)</p>

	<p>Option Board Non-Function The Option Board is disabled.</p>
	<p>Over-the-Air Programming Delay Timer Indicates time left before automatic restart of radio.</p>
	<p>Priority 1 Indicates Priority Talkgroup 1.</p>
	<p>Priority 2 Indicates Priority Talkgroup 2.</p>
	<p>Received Signal Strength Indicator (RSSI) The number of bars displayed represents the radio signal strength. Four bars indicate the strongest signal. This icon is only displayed while receiving.</p>
	<p>Response Inhibit Response Inhibit is enabled.</p>

² Only applicable for models with the latest software and hardware.

	Ring Only Ringing mode is enabled.
	Secure The Privacy feature is enabled.
	Shared Frequency Indicates radio is locking to shared control channel.
	Silent Ring Silent ring mode is enabled.
	Site Roaming The site roaming feature is enabled.
	Status Indicates a new status message.
	Tones Disable Tones are turned off.
	Unsecure The Privacy feature is disabled.







	Wi-Fi Excellent³ Wi-Fi signal is excellent.
	Wi-Fi Good³ Wi-Fi signal is good.
	Wi-Fi Average³ Wi-Fi signal is average.
	Wi-Fi Poor³ Wi-Fi signal is poor.
	Wi-Fi Unavailable³ Wi-Fi signal is unavailable.

Table 3: Advance Menu Icons

The following icons appear beside menu items that offer a choice between two options or as an indication that there is a sub-menu offering two options.

	Checkbox (Checked) Indicates that the option is selected.
---	---

³ Only applicable for XiR M8668i/CM7668i.



	<p>Checkbox (Empty) Indicates that the option is not selected.</p>
	<p>Solid Black Box Indicates that the option selected for the menu item with a sub-menu.</p>

Table 4: Bluetooth Device Icons

The following icons appear next to items in the list of Bluetooth-enabled devices available to indicate the device type.







	<p>Bluetooth Audio Device Bluetooth-enabled audio device, such as a headset.</p>
	<p>Bluetooth Data Device Bluetooth-enabled data device, such as a scanner.</p>
	<p>Bluetooth PTT Device Bluetooth-enabled PTT device, such as a PTT-Only Device (POD).</p>

Table 5: Call Icons

The following icons appear on the display during a call. These icons also appear in the Contacts list to indicate alias or ID type.

	<p>Bluetooth PC Call Indicates a Bluetooth PC Call in progress. In the Contacts list, it indicates a Bluetooth PC Call alias (name) or ID (number).</p>
	<p>Call Priority High Indicating Call Priority Level High is enabled.</p>
	<p>DGNA Call Indicates a DGNA Call is in progress.</p>
	<p>Dispatch Call The Dispatch Call contact type is used to send a text message to a dispatcher PC through a third-party Text Message Server.</p>











	<p>Group Call/All Call Indicates a Group Call or All Call in progress. In the Contacts list, it indicates a group alias (name) or ID (number).</p>
	<p>Private Call Indicates a Private Call in progress. In the Contacts list, it indicates a subscriber alias (name) or ID (number).</p>
	<p>Phone Call as Group/All Call Indicates a Phone Call as Group Call or All Call in progress. In the Contacts list, it indicates a group alias (name) or ID (number).</p>
	<p>Phone Call as Private Call Indicates a Phone Call as Private Call in progress. In the Contacts list, it indicates a phone alias (name) or ID (number).</p>

Table 6: Job Tickets Icons

The following icons appear momentarily on the display in the Job Ticket folder.

	<p>All Jobs Indicates all jobs listed.</p>
	<p>New Jobs Indicates new jobs.</p>
	<p>In Progress Jobs are transmitting. This is seen before indication for Job Tickets Send Failed or Sent Successfully.</p>
	<p>Send Failed Jobs cannot be sent.</p>
	<p>Sent Successfully Jobs have been successfully sent.</p>
	<p>Priority 1 Indicates Priority Level 1 for jobs.</p>



	Priority 2 Indicates Priority Level 2 for jobs.
	Priority 3 Indicates Priority Level 3 for jobs.

Table 7: Mini Notice Icons

The following icons appear momentarily on the display after an action to perform a task is taken.











	Failed Transmission (Negative) Failed action taken.
	Successful Transmission (Positive) Successful action taken.
	Transmission in Progress (Transitional) Transmitting. This is seen before indication for Successful Transmission or Failed Transmission.

Table 8: Sent Items Icons

The following icons appear at the top right corner of the display in the Sent Items folder.

 or 	In Progress The text message to a subscriber alias or ID is pending transmission, followed by waiting for acknowledgment. The text message to a group alias or ID is pending transmission.
 or 	Individual or Group Message Read The text message has been read.
 or 	Individual or Group Message Unread The text message has not been read.

	<p>Send Failed The text message cannot be sent.</p>
	<p>Sent Successfully The text message has been successfully sent.</p>

LED Indicator

The LED indicator shows the operational status of your radio.

Blinking Red

- Radio has failed the self-test upon powering up.
- Radio is receiving an emergency transmission.
- Radio is transmitting in low battery state.
- Radio has moved out of range if Auto-Range Transponder System is configured.
- Mute Mode is enabled.

Solid Green

- Radio is powering up.
- Radio is transmitting.
- Radio is sending a Call Alert or an emergency transmission.

Blinking Green

- Radio is receiving a call or data.
- Radio is retrieving Over-the-Air Programming transmissions over the air.
- Radio is detecting activity over the air.



NOTICE:

This activity may or may not affect the programmed channel of the radio due to the nature of the digital protocol.

Double Blinking Green

- Radio is receiving a privacy-enabled call or data.

Solid Yellow

- Radio is in Bluetooth Discoverable Mode.

Blinking Yellow

- Radio has yet to respond to a Call Alert.

Double Blinking Yellow

- Radio has Auto Roaming enabled.

Radio is actively searching for a new site.

Radio has yet to respond to a Group Call Alert.

Radio is locked.

Tones

The following are the tones that sound through on the radio speaker.



High Pitched Tone



Low Pitched Tone

Audio Tones

Audio tones provide you with audible indications of the status, or response to data received on the radio.



Continuous Tone

A monotone sound. Sounds continuously until termination.



Periodic Tone

Sounds periodically depending on the duration set by the radio. Tone starts, stops, and repeats itself.



Repetitive Tone

A single tone that repeats itself until it is terminated by the user.



Momentary Tone

Sounds once for a short duration set by the radio.

Indicator Tones

Indicator tones provide you with audible indications of the status after an action to perform a task is taken.



Positive Indicator Tone



Negative Indicator Tone

Registration

There are a number of registration-related messages that you may receive.

Registering

Typically, registration is sent to the system during power-up, Talkgroup change, or during site roaming. If a radio fails registration on a site, the radio automatically attempts to roam to another site. The radio temporarily removes the site where registration was attempted from the roaming list.

The indication means that the radio is busy searching for a site to roam, or that the radio has found a site successfully but is waiting for a response to the registration messages from the radio.

When **Registering** is displayed on the radio, a tone sounds and the yellow LED double flashes to indicate a site search.

If the indications persist, the user should change locations or if allowed, manually roam to another site.

Out of Range

A radio is deemed to be out of range when the radio is unable to detect a signal from the system or from the current site. Typically, this indication means that the radio is outside of the geographic outbound radio frequency (RF) coverage range.

When **Out of Range** is displayed on the radio, a repetitive tone sounds and the red LED flashes.

Contact your dealer or system administrator if the radio still receives out of range indications while being in an area with good RF coverage.

Talkgroup Affiliation Failed

A radio tries to affiliate to the Talkgroup specified in the channels or Unified Knob Position (UKP) during registration.

A radio that is in affiliation fail state is unable to make or receive calls from the Talkgroup that the radio is trying to affiliate to.

When a radio fails to affiliate with a Talkgroup, **UKP Alias** is displayed in the home screen with a highlighted background.

Contact your dealer or system administrator if the radio receives affiliation failure indications.

Register Denied

Registration denied indicators are received when the registration with the system is not accepted.

The radio does not indicate to the radio user the specific reason the registration was denied. Normally, a registration is denied when the system operator has disabled the access of the radio to the system.

When a radio is denied registration, Register Denied is displayed on the radio and the yellow LED double flashes to indicate a site search.

Zone and Channel Selections





This chapter explains the operations to select a zone or channel on your radio.



The radio can be programmed with a maximum of 250 Capacity Max Zones with a maximum of 160 Channels per zone. Each Capacity Max zone contains a maximum of 16 assignable positions. Each Capacity Max zone contains a maximum of 16 assignable positions.

Selecting Zones

Follow the procedure to select the required zone on your radio.

- 1 Do one of the following:
 - Press the programmed **Zone Selection** button. Proceed to [step 3](#).
 - Press  to access the menu.





-
- 2 Press  or  to Zone. Press  to select. The display shows  and the current zone.

-
- 3 Press  or  to the required zone. Press  to select. The display shows <Zone> Selected momentarily and returns to the selected zone screen.
-

Selecting Zones by Using the Alias Search

Follow the procedure to select the required zone on your radio by using the alias search.

- 1 Press  to access the menu.

- 2 Press  or  to Zone. Press  to select.
The display shows  and the current zone.

- 3 Enter the first character of the required alias.
The display shows a blinking cursor.

- 4 Enter the rest of the characters of the required alias.
The alias search is case-insensitive. If there are two or more entries with the same name, the display shows the entry listed first in the list.

The first text line shows the characters you entered.
The following text lines show the shortlisted search results.

- 5 Press  to select.

The display shows <Zone> Selected momentarily and returns to the selected zone screen.

Selecting a Call Type

Use the Channel Selector Knob to select a call type. This can be a Group Call, Broadcast Call, All Call, or Private Call, depending on how your radio is programmed. If you change the Channel Selector Knob to a different position (that has a call type assigned to it), this causes the radio to re-register with the Capacity Max System. The radio registers with the Talkgroup ID that has been programmed for the new Channel Selector Knob position call type.

Your radio does not operate when selected to an unprogrammed channel, use the Channel Selector Knob to select a programmed channel instead.

Once the required zone is displayed (if you have multiple zones in your radio), turn the programmed Channel Selector Knob to select the call type.

Selecting a Site

A site provides coverage for a specific area. In a multi-site network, the Capacity Max radio will automatically search for a new site when the signal level from the current site drops to an unacceptable level.

The Capacity Max system can support up to 250 sites.

Roam Request

A Roam Request tells the radio to search for a different site, even if the signal from the current site is acceptable.

If there are no sites available:

- The radio display shows `Searching` and continues to search through the list of sites.
- The radio will return to the previous site, if the previous site is still available.



NOTICE:

This is programmed by your dealer.

Press the programmed **Manual Site Roam** button.

You hear a tone, indicating the radio has switched to a new site. The display shows `Site ID <Site Number>`.

Site Lock On/Off

When toggled on, the radio searches the current site only.
When toggled off, the radio searches other sites in addition to the current site.

Press the programmed **Site Lock** button.

If the **Site Lock** function is toggled on:

- You hear a positive indicator tone, indicating the radio has locked to the current site.
- The display shows `Site Locked`.

If the **Site Lock** function is toggled off:

- You hear a negative indicator tone, indicating the radio is unlocked.

- The display shows `Site Unlocked`.

Site Restriction

In Capacity Max system, your radio administrator has the ability to decide which network sites your radio is and is not allowed to use.

The radio does not have to be reprogrammed to change the list of allowed and disallowed sites. If your radio attempts to register at a disallowed site, your radio receives indication that the site is denied. The radio then searches for a different network site.

When experiencing site restrictions, your radio displays `Register Denied` and the yellow LED double flashes to indicate a site search.

Site Trunking

A site must be able to communicate with the Trunk Controller to be considered as System Trunking.

If the site cannot communicate with the Trunk Controller in the system, a radio enters Site Trunking mode. While in Site Trunking, the radio provides a periodic audible and

visual indication to the user to inform the user of their limited functionality.

When a radio is in Site Trunking, the radio displays `Site Trunking` and a repetitive tone sounds.

The radios in Site Trunking are still able to make group and individual voice calls as well as send text messages to other radios within the same site. Voice consoles, logging recorders, phone gateways, and data applications cannot communicate to the radios at the site.

Once in Site Trunking, a radio that is involved in calls across multiple sites will only be able to communicate with other radios within the same site. Communication to and from other sites would be lost.



NOTICE:

If there are multiple sites that cover the current location of the radio and one of the sites enters Site Trunking, the radio roams to another site if within coverage.

Calls

This chapter explains the operations to receive, respond to, make, and stop calls.

You can select a subscriber alias or ID, or group alias or ID after you have selected a channel by using one of these features:

Alias Search

This method is used for Group, Private, and All Calls only with a keypad microphone.

Contacts List

This method provides direct access to the Contacts list.

Manual Dial (by using Contacts)

This method is used for Private and Phone Calls only with a keypad microphone.

Programmed Number Keys

This method is used for Group, Private, and All Calls only with a keypad microphone.



NOTICE:

You can only have one alias or ID assigned to a number key, but you can have more than one number key associated to an alias or ID. All the number keys on a keypad microphone can be assigned. See [Assigning Entries to Programmable Number Keys on page 394](#) for more information.

Programmed One Touch Access Button

This method is used for Group, Private, and Phone Calls only.

You can only have one ID assigned to a **One Touch Access** button with a short or long programmable button press. Your radio can have multiple **One Touch Access** buttons programmed.

Programmable Button

This method is used for Phone Calls only.

Volume/Channel Selector Knob

This method manually selects a subscriber alias or ID, or group alias or ID.

The LED lights up solid green while the radio is transmitting and blinks green when the radio is receiving.

**NOTICE:**

The LED lights up solid green while the radio is transmitting and double blinks green when the radio is receiving a privacy-enabled call.

To unscramble a privacy-enabled call, your radio must have the same Privacy Key, or the same Key Value and Key ID (programmed by your dealer), as the transmitting radio (the radio you are receiving the call from).

See [Privacy on page 443](#) for more information.

Group Calls

Your radio must be configured as part of a group to receive a call from or make a call to the group of users.

Making Group Calls

To make a call to a group of users, your radio must be configured as part of that group. Follow the procedure to make Group Calls on your radio.

- 1 Do one of the following:
 - Select a channel with the active group alias or ID. See [Selecting a Call Type on page 59](#).

- Press the programmed **One Touch Access** button.
-

- 2 Press the **PTT** button to make the call.

The green LED lights up. The first text line shows the **Group Call** icon and alias.

- 3 Do one of the following:

- Wait for the Talk Permit Tone to end and speak clearly into the microphone if enabled.
 - Wait for the **PTT** Sidetone to end and speak clearly into the microphone if enabled.
-

- 4 Release the **PTT** button to listen.

The green LED lights up when the target radio responds. The display shows the **Group Call** icon, and alias or ID, and the transmitting radio alias or ID.

- 5 If the Channel Free Indication feature is enabled, you hear a short alert tone the moment the transmitting radio releases the **PTT** button, indicating the channel is free for you to respond. Press the **PTT** button to respond to the call.



The call ends when there is no voice activity for a predetermined period.



The call initiator can press  to end a Group Call.

Making Group Calls by Using the Contacts List

Follow the procedure to make Group Calls on your radio by using the Contacts list.

- 1 Press  to access the menu.

- 2 Press  or  to **Contacts**. Press  to select.

- 3 Press  or  to the required alias or ID.
Press  to select.

- 4 Press the **PTT** button to make the call.
The green LED lights up.

The first line displays the subscriber alias or ID. The second line displays **Group Call** and the **Group Call** icon.

- 5 Do one of the following:
 - Wait for the Talk Permit Tone to end and speak clearly into the microphone if enabled.
 - Wait for the **PTT** Sidetone to end and speak clearly into the microphone if enabled.

- 6 Release the **PTT** button to listen.
The green LED blinks when any user in the group responds. The display shows the **Group Call** icon, and alias or ID, and the transmitting radio alias or ID.

- 7 If the Channel Free Indication feature is enabled, you hear a short alert tone the moment the transmitting radio releases the **PTT** button, indicating the channel is free for you to respond. Press the **PTT** button to respond to the call.
The call ends when there is no voice activity for a predetermined period.

The call initiator can press  to end the Group Call.

You hear a short tone. The display shows `Call Ended`.

Making Group Calls by Using the Programmable Number Key

Follow the procedure to make Group Calls on your radio by using the programmable number key.

- 1 Long press the programmed number key to the predefined alias or ID when you are on the Home screen.

If a number key is assigned to an entry in a particular mode, this feature is not supported when you long press the number key in another mode.

A negative indicator tone sounds if the number key is not associated to an entry.

- 2 Press the **PTT** button to make the call.
The green LED lights up.
-

- 3 Release the **PTT** button to listen.

The green LED blinks when any user in the group responds.

- 4 If the Channel Free Indication feature is enabled, you hear a short alert tone the moment the transmitting radio releases the **PTT** button, indicating the channel is free for you to respond. Press the **PTT** button to respond to the call.

The call ends when there is no voice activity for a predetermined period. The radio returns to the screen you were on before initiating the call.

The call initiator can press  to end the Group Call.



See [Assigning Entries to Programmable Number Keys on page 394](#) for more information.



Making Group Calls by Using the Alias Search

You can also use alias or alphanumeric search to retrieve the required subscriber alias. This feature is only applicable



while in Contacts. Follow the procedure to make any calls by using the alias search.

- 1 Press  to access the menu.

- 2 Press  or  to Contacts. Press  to select.
The display shows the entries in alphabetical order.

- 3 Press  or  to the required subscriber alias or ID. The first line of the display shows Phone Number: . The second line of the display shows a blinking cursor. Use the keypad to enter a telephone number.

- 4 Press  to select. If the entry selected is empty, a negative indicator tone sounds and the display shows Phone Call Invalid #.

- 5 Press  or  to Call Phone and Press  to select. If the access code was not preconfigured in the Contacts list, the first line of the display shows

Access Code: . The second line of the display shows a blinking cursor. Enter the access code and



press the  button to proceed. If successful, the DTMF tone sounds. You hear the dialing tone of the telephone user. The first line of the display shows the subscriber alias or ID, and the RSSI icon. The second line of the display shows Phone Call and the Phone Call icon. If unsuccessful, a tone sounds and the display shows Phone Call Failed. Your radio returns to the Access Code input screen. If the access code was preconfigured in the Contacts list, the radio returns to the screen you were on prior to initiating the call.

- 6 Press the **PTT** button to talk and release it to listen. The **RSSI** icon disappears during transmission.

- 7 To enter extra digits, if requested by the Phone Call, do one of the following.
 - Press any keypad key to begin the input of the extra digits. The first line of the display shows Extra Digits: . The second line of the display shows a blinking cursor. Enter the extra digits and press the  button to proceed. The DTMF

tone sounds and the radio returns to the previous screen.

- Press **One Touch Access** button. The DTMF tone sounds. If the entry for the **One Touch Access** button is empty, a negative indicator tone sounds.

-
- 8 Press  to end the call. If deaccess code was not preconfigured in the Contacts list, the first line of the display shows `De-Access Code:`. The second line of the display shows a blinking cursor. Enter the deaccess code and press  to proceed. The radio returns to the previous screen. The DTMF tone sounds and the display shows `Ending Phone Call`. If successful, a tone sounds and the display shows `Phone Call Ended`. Your radio returns to the Phone Call screen. If unsuccessful, your radio returns to the Phone Call screen. When you press the **PTT** button while in the Phone Contacts screen, a tone sounds and the display shows `Press OK to Place Phone Call`. When the telephone user ends the call, a tone sounds and the display shows `Phone Call Ended`. If the call ends while you are entering the extra digits

requested by the Phone Call, your radio returns to the screen you were on prior to initiating the call.



-
- 9 If the Channel Free Indication feature is enabled, you hear a short alert tone the moment the transmitting radio releases the **PTT** button, indicating the channel is free for you to respond. Press the **PTT** button to respond to the call.

The call ends when there is no voice activity for a predetermined period. A tone sounds. The display shows `Call Ended`.

The call initiator can press  to end the Group Call.

**NOTICE:**

During the channel access, press  to dismiss the call attempt and a tone sounds button or to exit

alias search. Press  button or  to exit alias search. During the call, when you press **One Touch Access** button with the deaccess code preconfigured or enter the deaccess code as the input for extra digits, your radio attempts to end the call. During channel access and access/deaccess code or extra digits transmission, you radio responds to On/Off button, Volume Knob, and Channel Rocker only. A tone sounds for every invalid input.

Responding to Group Calls

Follow the procedure to respond to Group Calls on your radio.

When you receive a Group Call:

- The green LED blinks.
- The display shows the **Group Call** icon at the top right corner.
- The first text line shows the caller alias.

- The second text line displays the group call alias.
- Your radio unmutes and the incoming call sounds through the speaker.

1 Do one of the following:

- If the Channel Free Indication feature is enabled, you hear a short alert tone the moment the transmitting radio releases the **PTT** button, indicating the channel is free for you to respond. Press the **PTT** button to respond to the call.
- If the Voice Interrupt feature is enabled, press the **PTT** button to interrupt the audio from the transmitting radio and free the channel for you to respond.

The green LED lights up.

2 Do one of the following:

- Wait for the Talk Permit Tone to end and speak clearly into the microphone if enabled.
- Wait for the **PTT** Sidetone to end and speak clearly into the microphone if enabled.

3 Release the **PTT** button to listen.

The call ends when there is no voice activity for a predetermined period.

Broadcast Call

A Broadcast Call is a one-way voice call from any user to an entire talkgroup.

The Broadcast Call feature allows only the call initiating user to transmit to the talkgroup, while the recipients of the call cannot respond.

The broadcast initiator can also end the broadcast call. To receive a call from a group of users, or to call a group of users, the radio must be configured as part of a group.

Making Broadcast Calls

Follow the procedure to make Broadcast Calls on your radio.

- 1 Do one of the following:
 - Select a channel with the active group alias or ID. See [Selecting a Call Type on page 59](#).
 - Press the programmed **One Touch Access** button.
-

- 2 Press the **PTT** button to make the call.

The green LED lights up. The display shows the **Group Call** icon and alias.



- 3 Do one of the following:
 - Wait for the Talk Permit Tone to end and speak clearly into the microphone if enabled.
 - Wait for the **PTT** Sidetone to end and speak clearly into the microphone if enabled.



The call initiator can press  to end the Broadcast Call.

Making Broadcast Calls Using the Contact List

Follow the procedure to make Broadcast Calls on your radio using the Contacts list.

- 1 Press  to access the menu.
-

2 Press  or  to **Contacts**. Press  to select.

3 Press  or  to the required alias or ID.
Press  to select.

4 Press the **PTT** button to make the call.

The green LED blinks.

The first line displays the subscriber alias or ID. The second line displays **Group Call** and the **Group Call** icon.

5 Do one of the following:

- Wait for the Talk Permit Tone to end and speak clearly into the microphone if enabled.
- Wait for the **PTT** Sidetone to end and speak clearly into the microphone if enabled.

The call initiator can press  to end the Broadcast Call.

Making Broadcast Calls Using the Programmable Number Key

Follow the procedure to make Broadcast Calls on your radio using the programmable number key.

1 Long press the programmed number key to the predefined alias or ID when you are on the Home screen.

If a number key is assigned to an entry in a particular mode, this feature is not supported when you long press the number key in another mode.

A negative indicator tone sounds if the number key is not associated to an entry.

2 Press the **PTT** button to make the call.

The green LED lights up. The display shows the **Group Call** icon at the top right corner. The first text line shows the caller alias.

3 Do one of the following:

- Wait for the Talk Permit Tone to end and speak clearly into the microphone if enabled.

- Wait for the **PTT** Sidetone to end and speak clearly into the microphone if enabled.

The call initiator can press  to end the Broadcast Call.



NOTICE:

Recipient users are not allowed to Talkback during a Broadcast Call. The display shows **Talkback Prohibit**. The Talkback Prohibit Tone will sound momentarily if the **PTT** button is pressed during a Broadcast Call.

Receiving Broadcast Calls

Follow the procedure to receive a Broadcast Call on your radio.

When you receive a Broadcast Call:

- The green LED blinks.
- The display shows the **Group Call** icon at the top right corner.
- The first text line shows the caller alias.
- The second text line displays the group call alias.
- Your radio unmutes and the incoming call sounds through the speaker.

Private Call

A Private Call is a call from an individual radio to another individual radio.

There are two ways to set up a Private Call.

- The first call type is called Off Air Call Set-Up (OACSU). OACSU sets up the call after performing a radio presence check and completes the call automatically.
- The second type is called Full Off Air Call Set-Up (FOACSU). FOACSU also sets up the call after performing a radio presence check. However, FOACSU calls require user acknowledgment to complete the call and allows the user to either Accept or Decline the call.

The type of call is configured by the system administrator.

**NOTICE:**

Both the call initiator and recipient are able to terminate an on-going Private Call by pressing



Making Private Calls

Your radio must be programmed for you to initiate a Private Call. If this feature is not enabled, you hear a negative indicator tone when you initiate the call. Follow the procedure to make Private Calls on your radio. If the target radio is not available, a short tone sounds and the display show `Party Not Available`.

- 1 Do one of the following:
 - Select a channel with the active subscriber alias or ID. See [Selecting a Call Type on page 59](#).
 - Press the programmed **One Touch Access** button.

- 2 Press the **PTT** button to make the call.

The green LED lights up. The display shows the **Private Call** icon, the subscriber alias, and call status.

- 3 Wait for the Talk Permit Tone to end and speak clearly into the microphone if enabled.

- 4 Release the **PTT** button to listen.

The green LED lights up when the target radio responds.

- 5 The call ends when there is no voice activity for a predetermined period. You will hear a short tone. The display shows `Call Ended`.

Both the call initiator and recipient are able to

terminate an on-going Private Call by pressing .

Making Private Calls by Using the Programmable Number Key

Follow the procedure to make Private Calls on your radio by using the programmable number key.

- 1 Long press the programmed number key to the predefined alias or ID when you are on the Home screen.

If a number key is assigned to an entry in a particular mode, this feature is not supported when you long press the number key in another mode.

A negative indicator tone sounds if the number key is not associated to an entry.

2 Press the **PTT** button to make the call.

The green LED lights up. The display shows the **Private Call** icon at the top right corner. The first text line shows the caller alias. The second text line shows the call status.

3 Release the **PTT** button to listen.

The green LED blinks when the target radio responds. The display shows the destination alias.

4 The call ends when there is no voice activity for a predetermined period. You will hear a short tone. The display shows `Call Ended`.

Both the call initiator and recipient are able to terminate an on-going Private Call by pressing .

See [Assigning Entries to Programmable Number Keys on page 394](#) for more information.

Making Private Calls by Using the Alias Search

1 Press to access the menu.

2 Press or to `Contacts`. Press to select.

The display shows the entries in alphabetical order.

3 Press or to the required subscriber alias or ID. The first line of the display shows `Phone Number:`. The second line of the display shows a blinking cursor. Use the keypad to enter a telephone number.

4 Press to select. If the entry selected is empty, a negative indicator tone sounds and the display shows `Phone Call Invalid #`.

5 Press or to `Call Phone` and Press to select. If the access code was not preconfigured



in the Contacts list, the first line of the display shows `Access Code:`. The second line of the display shows a blinking cursor. Enter the access code and

press the  button to proceed. If successful, the DTMF tone sounds. You hear the dialing tone of the telephone user. The first line of the display shows the subscriber alias or ID, and the **RSSI** icon. The second line of the display shows `Phone Call` and the **Phone Call** icon. If unsuccessful, a tone sounds and the display shows `Phone Call Failed`. Your radio returns to the `Access Code` input screen. If the access code was preconfigured in the Contacts list, the radio returns to the screen you were on before initiating the call.

-
- 6 Press the **PTT** button to talk and release it to listen. The **RSSI** icon disappears during transmission.
-
- 7 To enter extra digits, if requested by the `Phone Call`, do one of the following.
- Press any keypad key to begin the input of the extra digits. The first line of the display shows `Extra Digits:`. The second line of the display shows a blinking cursor. Enter the extra digits and press the  button to proceed. The DTMF

tone sounds and the radio returns to the previous screen.

- Press **One Touch Access** button. The DTMF tone sounds. If the entry for the **One Touch Access** button is empty, a negative indicator tone sounds.

-
- 8 Press  to end the call. If deaccess code was not preconfigured in the Contacts list, the first line of the display shows `De-Access Code:`. The second line of the display shows a blinking cursor. Enter the deaccess code and press  to proceed. The radio returns to the previous screen. The DTMF tone sounds and the display shows `Ending Phone Call`. If successful, a tone sounds and the display shows `Phone Call Ended`. Your radio returns to the `Phone Call` screen. If unsuccessful, your radio returns to the `Phone Call` screen. When you press the **PTT** button while in the `Phone Contacts` screen, a tone sounds and the display shows `Press OK to Place Phone Call`. When the telephone user ends the call, a tone sounds and the display shows `Phone Call Ended`. If the call ends while you are entering the extra digits

requested by the Phone Call, your radio returns to the screen you were on before initiating the call.



- 9 The call ends when there is no voice activity for a predetermined period. You will hear a short tone. The display shows `Call Ended`.

Both the call initiator and recipient are able to terminate an on-going Private Call by pressing .



NOTICE:

During the channel access, press  to dismiss the call attempt and a tone sounds button or to exit

alias search. Press  button or  to exit alias search. During the call, when you press **One Touch Access** button with the deaccess code preconfigured or enter the deaccess code as the input for extra digits, your radio attempts to end the call.

Making a Private Call with a One Touch Call Button

The One Touch Call feature allows you to easily make a Private Call to a pre-defined Private Call alias or ID. This

feature can be assigned to a short or long programmable button press.

You can only have one alias or ID assigned to a One Touch Call button. Your radio can have multiple One Touch Call buttons programmed.

- 1 Press the programmed **One Touch Call** button to make a Private Call to the pre-defined Private Call alias or ID.

- 2 Press the **PTT** button to make the call.

The LED lights up solid green.

The display shows the Private Call alias or ID.

- 3 Wait for the Talk Permit Tone to finish (if enabled) and speak clearly into the microphone.

- 4 Release the **PTT** button to listen.

When the target radio responds, the LED blinks green.



If there is no voice activity for a predetermined period of time, the call ends.



Both the call initiator and recipient are able to terminate an on-going Private Call by pressing .



Making Private Calls by Using the Manual Dial

Follow the procedure to make Private Calls on your radio by using the manual dial.



- 1 Press  to access the menu.

- 2 Press  or  to **Contacts**. Press  to select.

- 3 Press  or  to **Manual Dial**. Press  to select.

- 4 Press  or  to **Radio Number**. Press  to select.

- 5 Do one of the following:

- Enter the subscriber ID, and press  to proceed.
 - Edit the previously dialed subscriber ID, and press  to proceed.
-

- 6 Press the **PTT** button to make the call.
The green LED lights up. The display shows the destination alias.

- 7 Wait for the Talk Permit Tone to end and speak clearly into the microphone if enabled.

- 8 Release the **PTT** button to listen.
The green LED lights up when the target radio responds. The display shows the transmitting user alias or ID.

- 9 If the Channel Free Indication feature is enabled, you hear a short alert tone the moment the transmitting radio releases the **PTT** button, indicating the channel is free for you to respond. Press the **PTT** button to respond to the call.

The call ends when there is no voice activity for a predetermined period. A tone sounds. The display shows **Call Ended**.

Both the call initiator and recipient are able to terminate an on-going Private Call by pressing .

Receiving Private Calls

When you receive Private Calls configured as Off Air Call Set-Up (OACSU):

- The green LED blinks.
- Your radio unmutes and the incoming call sounds through the speaker.





NOTICE:

Depending on how your radio is configured, either OACSU or Full Off Air Call Set-Up (FOACSU), responding to Private Calls may or may not require user acknowledgment.

For the OACSU configuration, your radio unmutes and the call connects automatically.

Accepting Private Calls

When you receive Private Calls configured as Full Off Air Call Set-Up (FOACSU):

- The green LED blinks.
- 1 To accept a Private Call configured as FOACSU, do one of the following:
 - Press  or  to **Accept** and press  to answer a Private Call.
 - Press the **PTT** button on any entry.

The green LED lights up.

- 2 Wait for the Talk Permit Tone to end and speak clearly into the microphone if enabled.
-

3 Release the **PTT** button to listen.

The call ends when there is no voice activity for a predetermined period. A tone sounds. The display shows **Call Ended**.



NOTICE:

Both the call initiator and recipient are able to terminate an on-going Private Call by





pressing .

Declining Private Calls

When you receive Private Calls configured as Full Off Air Call Set-Up (FOACSU):

- The green LED blinks.

To decline a Private Call configured as FOACSU, do one of the following:

- Press  or  to **Reject** and press  to decline a Private Call.
- Press  to decline a Private Call.

All Calls

An All Call is a call from an individual radio to every radio on the site or every radio at a group of sites, depending on system configuration.

An All Call is used to make important announcements, requiring full attention from the user. The users on the system cannot respond to an All Call.

Capacity Max supports Site All Call and Multi-site All Call. The system administrator may configure one or both of these in your radio.



NOTICE:

Subscribers can support System-Wide All Calls but Motorola Solutions infrastructure does not support System-Wide All Calls.

Making All Calls

Your radio must be programmed for you to make an All Call. Follow the procedure to make All Calls on your radio.

- 1 Select a channel with the active All Call group alias or ID. See [Selecting a Call Type on page 59](#).

2 Press the **PTT** button to make the call.

The green LED lights up. The display shows the **Group Call** icon and either `All Call`, `Site All Call`, or `Multi Site Call` depending on the type of configuration.

3 Do one of the following:

- Wait for the Talk Permit Tone to end and speak clearly into the microphone if enabled.
- Wait for the **PTT** Sidetone to end and speak clearly into the microphone if enabled.

Users on the channel cannot respond to an All Call.

The call initiator can press  to end the All Call.

If a number key is assigned to an entry in a particular mode, this feature is not supported when you long press the number key in another mode.

A negative indicator tone sounds if the number key is not associated to an entry.

2 Press the **PTT** button to make the call.

The green LED lights up. The display shows the **Group Call** icon and either `All Call`, `Site All Call`, or `Multi Site Call` depending on the type of configuration.

3 Do one of the following:

- Wait for the Talk Permit Tone to end and speak clearly into the microphone if enabled.
- Wait for the **PTT** Sidetone to end and speak clearly into the microphone if enabled.

The call initiator can press  to end the All Call.

See [Assigning Entries to Programmable Number Keys on page 394](#) for more information.



Making All Calls by Using the Programmable Number Key



Follow the procedure to make All Calls on your radio by using the programmable number key.

- 1 Long press the programmed number key assigned to the predefined alias or ID when you are on the Home screen.



Making All Calls by Using the Alias Search

- 1 Press  to access the menu.

- 2 Press  or  to `Contacts`. Press  to select.
The display shows the entries in alphabetical order.

- 3 Press  or  to the required subscriber alias or ID. The first line of the display shows `Phone Number:`. The second line of the display shows a blinking cursor. Use the keypad to enter a telephone number.

- 4 Press  to select. If the entry selected is empty, a negative indicator tone sounds and the display shows `Phone Call Invalid #`.

- 5 Press  or  to `Call Phone`. Press  to select. If the access code was not preconfigured in

the `Contacts` list, the first line of the display shows `Access Code:`. The second line of the display shows a blinking cursor. Enter the access code and

press the  button to proceed. If successful, the DTMF tone sounds. You hear the dialing tone of the telephone user. The first line of the display shows the subscriber alias or ID, and the RSSI icon. The second line of the display shows `Phone Call` and the `Phone Call` icon. If unsuccessful, a tone sounds and the display shows `Phone Call Failed`. Your radio returns to the `Access Code` input screen. If the access code was preconfigured in the `Contacts` list, the radio returns to the screen you were on prior to initiating the call.

- 6 Press the **PTT** button to talk and release it to listen. The RSSI icon disappears during transmission.

- 7 To enter extra digits, if requested by the `Phone Call`, do one of the following.
 - Press any keypad key to begin the input of the extra digits. The first line of the display shows `Extra Digits:`. The second line of the display shows a blinking cursor. Enter the extra digits and press the  button to proceed. The DTMF

tone sounds and the radio returns to the previous screen.

- Press **One Touch Access** button. The DTMF tone sounds. If the entry for the **One Touch Access** button is empty, a negative indicator tone sounds.

8

Press  to end the call. If deaccess code was not preconfigured in the Contacts list, the first line of the display shows `De-Access Code:`. The second line of the display shows a blinking cursor. Enter the

deaccess code and press  to proceed. The radio returns to the previous screen. The DTMF tone sounds and the display shows `Ending Phone Call`. If successful, a tone sounds and the display shows `Phone Call Ended`. Your radio returns to the Phone Call screen. If unsuccessful, your radio returns to the Phone Call screen. When you press the **PTT** button while in the Phone Contacts screen, a tone sounds and the display shows `Press OK to Place Phone Call`. When the telephone user ends the call, a tone sounds and the display shows `Phone Call Ended`. If the call ends while you are entering the extra digits

requested by the Phone Call, your radio returns to the screen you were on prior to initiating the call.



NOTICE:

The call initiator can press  to end the All Call.

Receiving All Calls

When you receive an All Call, the following occur:

- A tone sounds.
- The green LED blinks.
- The display shows the **Group Call** icon at the top right corner.
- The first text line shows the caller alias ID.
- The second text line displays either `All Call`, `Site All Call`, or `Multi Site Call` depending on the type of configuration.
- Your radio unmutes and the incoming call sounds through the speaker.

The radio returns to the screen before receiving the All Call when the call ends.

If the Channel Free Indication feature is enabled, you hear a short alert tone when the transmitting radio releases the

PTT button, indicating the channel is free for you to use. You cannot respond to an All Call.



NOTICE:

The radio stops receiving the All Call if you switch to a different channel while receiving the call. You are not able to continue with any menu navigation or editing until the call ends during an All Call.

Phone Calls

A Phone Call is a call in between an individual radio or a group of radios and a telephone.

Depending on how the radio is configured, the following features may or may not be made available:

- Dual Tone Multi Frequency (DTMF) tone
- De-access code
- Displaying of caller alias or ID on receiving a phone call
- Ability to reject or accept a phone call

The Phone Call capability can be enabled by assigning and setting up phone numbers on the system. Check with your system administrator to determine how your radio has been programmed.

Making Phone Calls

Follow the procedure to make Phone Calls on your radio.

- 1 Press the programmed **One Touch Access** button to the predefined alias or ID.

If the entry for the **One Touch Access** button is empty, a negative indicator tone sounds.

If the access code is not preconfigured in the Contact List, the display shows `Access Code:.`

- 2 Enter the access code, and press  to proceed.

The access or deaccess code cannot be more than 10 characters.

- 3 Press the **PTT** button to respond to the call.
-

- 4 Release the **PTT** button to listen.
-

- 5 Enter extra digits with the keypad if requested by the call, and press  to proceed.

If the call ends while you are entering the extra digits requested by the call, your radio returns to the screen you were on before initiating the call.

The DTMF Tone sounds. Your radio returns to the previous screen.

6 Press  to end the call.

7 Do one of the following:

- If the deaccess code was not preconfigured, enter the deaccess code when the display shows

De-Access Code:, and press  to proceed. The radio returns to the previous screen.

- Press the programmed **One Touch Access** button. If the entry for the **One Touch Access** button is empty, a negative indicator tone sounds.

The DTMF Tone sounds and the display shows Ending Phone Call.

If the call ends successfully:



- A tone sounds.
- The display shows Call Ended.

If the call fails to end, the radio returns to the Phone Call screen. Repeat the last two steps or wait for the telephone user to end the call.

Making Phone Calls with the Programmable Button

Follow the procedure to make Phone Calls with the programmable button.

1 Press the programmed **Phone** button to enter into the Phone Entry list.

2 Press  or  to the required alias or ID. Press  to select.

If the access code was not preconfigured in the Contacts list, the display shows Access Code:.

Enter the access code and press the  button to proceed.

The green LED lights up. The display shows **Phone Call** icon, subscriber alias or ID, and call status.

If the call-setup is successful:

- The DTMF tone sounds.
- You hear the call waiting tone of the telephone user.
- The display shows **Phone Call** icon, subscriber alias or ID, Phone Call, and call status.

If call-setup is unsuccessful:

- A tone sounds.
- The display shows Phone Call Failed.
- Your radio returns to the Access Code input screen. If the access code was preconfigured in the Contacts list, the radio returns to the screen you were on prior to initiating the call.

3 Press the **PTT** button to talk. Release the **PTT** button to listen. The RSSI icon disappears during transmission.

4 To enter extra digits, if requested by the Phone Call. Do one of the following:

- Press any keypad key to begin the input of the extra digits. The display shows Extra Digits: and a blinking cursor. Enter the extra digits and

press the  button to proceed. The DTMF tone sounds and the radio returns to the previous screen.

- Press **One Touch Access** button. The DTMF tone sounds. If the entry for the **One Touch Access** button is empty, a negative indicator tone sounds.

5 Press  to end the call.

If deaccess code was not preconfigured in the Contacts list, the display shows De-Access Code:.

Enter the deaccess code and press the  button to proceed.

The DTMF tone sounds and the display shows Ending Phone Call.

If the end-call-setup is successful, a tone sounds and the display shows Call Ended.

If the end-call-setup is unsuccessful, your radio returns to the Phone Call screen.

When you press **PTT** button while in the Phone Contacts screen, a tone sounds and the display shows Press OK to Place Call.

When the telephone user ends the call, a tone sounds and the display shows `Phone Call Ended`.

If the call ends while you are entering the extra digits requested by the Phone Call, your radio returns to the screen you were on prior to initiating the call.



NOTICE:

During channel access, press  to dismiss the call attempt and a tone sounds.



During the call, when you press **One Touch Access** button with the deaccess code preconfigured or enter the deaccess code as the input for extra digits, your radio attempts to end the call.



During channel access and access/deaccess code or extra digits transmission, your radio responds to **On/Off** button, **Volume On/Off Volume Knob**, and **Channel Up/Down Channel Rocker** only. A tone sounds for every invalid input.

Making Phone Calls by Using the Contacts List



Follow the procedure to make Phone Calls on your radio by using the Contacts list.

- 1 Press  to access the menu.

- 2 Press  or  to `Contacts`. Press  to select.
The display shows the entries in alphabetical order.

- 3 Press  or  to the required alias or ID.
Press  to select.
When you press the **PTT** button while on the Phone Contacts screen:
 - A negative indicator tone sounds.
 - The display shows `Press OK to Place Call`.
 If the selected entry is empty:
 - A negative indicator tone sounds.

- The display shows Phone Call Invalid #.

-
- 4 Press  or  to Call Phone. Press  to select.

The display shows Access Code: if the access code was not preconfigured.

-
- 5 Enter the access code, and press  to proceed.

The access or deaccess code cannot be more than 10 characters.

The display shows Calling, subscriber alias or ID, and the **Phone Call** icon.

If the call is successful:

- The DTMF Tone sounds.
- You hear the call waiting tone of the telephone user.
- The display shows the subscriber alias or ID, the **Phone Call** icon, and Phone Call.

If the call is unsuccessful:

- A tone sounds.

- The display shows Phone Call Failed and then, Access Code:.
- Your radio returns to the screen you were on prior to initiating the call if the access code has been preconfigured in the Contacts list.

-
- 6 Press the **PTT** button to respond to the call.

The **RSSI** icon disappears.

-
- 7 Release the **PTT** button to listen.

-
- 8 Enter extra digits with the keypad if requested by the call, and press  to proceed.

If the call ends while you are entering the extra digits requested by the call, your radio returns to the screen you were on prior to initiating the call.

The DTMF Tone sounds. Your radio returns to the previous screen.

-
- 9 Press  to end the call.
-

10 If the deaccess code was not preconfigured, enter the deaccess code when the display shows De-

Access Code:, and press  to proceed.

The radio returns to the previous screen. The DTMF Tone sounds and the display shows Ending Phone Call.

If the call ends successfully:

- A tone sounds.
- The display shows Call Ended.

If the call fails to end, the radio returns to the Phone Call screen. Repeat [step 9](#) and [step 10](#), or wait for the telephone user to end the call. When you press the PTT button while in the Phone Contacts screen, as tone sounds and the display shows Press OK to Place Call.

When the telephone user ends the call, a tone sounds and the display shows Phone Call Ended.

If the call ends while you are entering the extra digits requested by the Phone Call, your radio returns to the screen you were on prior to initiating the call.



NOTICE:

During the channel access, press  to dismiss the call attempt and a tone sounds.



During the call, when you press **One Touch Access** button with the deaccess code preconfigured or enter the deaccess code as the input for extra digits, your radio attempts to end the call.

During channel access and access/deaccess code or extra digits transmission, you radio responds to **On/Off** button, **Volume Knob**, and **Channel Rocker** only. A tone sounds for every invalid input.



Making Phone Calls by Using the Alias Search

You can also use alias or alphanumeric search to retrieve the required subscriber alias. This feature is only applicable while in Contacts. Follow the procedure to make Phone Calls on your radio by using the alias search.

- 1** Press  to access the menu.

- 2 Press  or  to `Contacts`. Press  to select.

The display shows the entries in alphabetical order.

- 3 Press  or  to the required subscriber alias or ID.
-

- 4 Press  to select. If the entry selected is empty, a negative indicator tone sounds and the display shows `Phone Call Invalid #`.
-

- 5 Press  or  to `Call Phone`. Press  to select.

If the access code was not preconfigured in the `Contacts` list, the display shows `Access Code:` and a blinking cursor. Enter the access code and press the  button to proceed.

If successful:

- The DTMF tone sounds.
- You hear the call waiting tone of the telephone user.

- The display shows the subscriber alias or ID, the **RSSI** icon, `Phone Call`, and the **Phone Call** icon.

If unsuccessful:

- A tone sounds.
 - The display shows `Phone Call Failed`.
 - Your radio returns to the `Access Code` input screen. If the access code was preconfigured in the `Contacts` list, the radio returns to the screen you were on prior to initiating the call.
-

- 6 Press the **PTT** button to talk and release it to listen. The **RSSI** icon disappears during transmission.
-

- 7 To enter extra digits, if requested by the `Phone Call`, do one of the following.

- Press any keypad key to begin the input of the extra digits. The display shows `Extra Digits:` and a blinking cursor. Enter the extra digits and press the  button to proceed. The DTMF tone sound

- Press **One Touch Access** button. The DTMF tone sounds. If the entry for the **One Touch Access** button is empty, a negative indicator tone sounds and the radio returns to the previous screen.
-

8 Press  to end the call.

If deaccess code was not preconfigured in the Contacts list, the display shows `De-Access Code:` and a blinking cursor. Enter the deaccess code and press  to proceed.

The radio returns to the previous screen. The DTMF tone sounds and the display shows `Ending Phone Call`.

If successful:

- A tone sounds.
- The display shows `Phone Call Ended`.
- Your radio returns to the Phone Call screen.



If unsuccessful:

- Your radio returns to the Phone Call screen.

- When you press the **PTT** button while in the Phone Contacts screen, a tone sounds and the display shows `Press OK to Place Phone Call`.
 - When the telephone user ends the call, a tone sounds and the display shows `Phone Call Ended`.
 - If the call ends while you are entering the extra digits requested by the Phone Call, your radio returns to the screen you were on prior to initiating the call.
-

**NOTICE:**



During the channel access, press  to dismiss the call attempt and a tone sounds button or to exit



alias search. Press  button or  to exit alias search. During the call, when you press **One Touch Access** button with the deaccess code preconfigured or enter the deaccess code as the input for extra digits, your radio attempts to end the call. During channel access and access/deaccess code or extra digits transmission, you radio responds to On/Off button, Volume Knob, and Channel Rocker only. A tone sounds for every invalid input.

Making Phone Calls by Using the Manual Dial

Follow the procedure to make Phone Calls on your radio by using the manual dial.

- 1 Press  to access the menu.
-

- 2 Press  or  to **Contacts**. Press  to select.
-

- 3 Press  or  to **Manual Dial**. Press  to select.
-

- 4 Press  or  to **Phone Number**. Press  to select.

The display shows **Number:** and a blinking cursor.

- 5 Enter the telephone number, and press  to proceed.

The display shows **Access Code:** and a blinking cursor if the access code was not preconfigured.

- 6 Enter the access code, and press  to proceed. The access or deaccess code cannot be more than 10 characters.

The green LED lights up. The display shows the **Phone Call** icon, subscriber alias, and call status.

If the call is successful:

- The DTMF Tone sounds.
- You hear the call waiting tone of the telephone user.
- The display shows subscriber alias and the **Phone Call** icon.

If the call is unsuccessful:

- A tone sounds.
- The display shows `Phone Call Failed` and then, `Access Code:`.
- Your radio returns to the screen you were on before initiating the call if the access code has been preconfigured in the Contacts list.

- Press the programmed **One Touch Access** button. If the entry for the **One Touch Access** button is empty, a negative indicator tone sounds.

The DTMF Tone sounds and the display shows `Ending Phone Call`.

If the call ends successfully:

- A tone sounds.
- The display shows `Call Ended`.

If the call fails to end, the radio returns to the Phone Call screen. Repeat [step 7](#), or wait for the telephone user to end the call.

7 Press  to end the call.

8 Do one of the following:

- If the deaccess code was not preconfigured, enter the deaccess code when the display shows `De-Access Code:`, and press  to proceed. The radio returns to the previous screen.

**NOTICE:**

When you press **PTT** button while in the Phone Contacts screen, a tone sounds and the display shows `Press OK to Place Phone Call`.

When the telephone user ends the call, a tone sounds and the display shows `Call Ended`.

If the call ends while you are entering the extra digits requested by the Phone Call, your radio returns to the screen you were on before initiating the call.

During the channel access, press  to dismiss the call attempt and a tone sounds.

During the call, when you press **One Touch Access** button with the deaccess code preconfigured or enter the deaccess code as the input for extra digits, your radio attempts to end the call.

During channel access and access/deaccess code or extra digits transmission, your radio responds to **On/Off** button, **Volume Knob**,

and **Channel Rocker** only. A tone sounds for every invalid input.



Dual Tone Multi Frequency

The Dual Tone Multi Frequency (DTMF) feature allows the radio to operate in a radio system with an interface to the telephone systems.

You can turn off the DTMF tone by disabling all radio tones and alerts. See [Turning Radio Tones/Alerts On or Off on page 194](#) for more information.

Initiating DTMF Calls

Follow the procedure to initiate DTMF calls on your radio.

- 1 Press and hold the **PTT** button.
-
- 2 Do one of the following:
 - Enter the desired number to initiate a DTMF call.
 - Press  to initiate a DTMF call.
 - Press  to initiate a DTMF call.
-

Responding to Phone Calls as All Calls

When you receive a Phone Call as an All Call, the receiving radio is unable to talkback or respond. The recipient user is also not allowed to end the All Call.

When you receive a Phone Call as an All Call:

- The display shows the **Phone Call** icon at the top right corner.
- The display shows either `All Call`, `Site All Call`, or `Multi Site Call` depending on the type of configuration and Phone Call.
- The green LED blinks.
- Your radio unmutes and the incoming call sounds through the speaker.

Responding to Phone Calls as Group Calls

Follow the procedure to respond to Phone Calls as Group Calls on your radio.

When you receive a Phone Call as a Group Call:

- The display shows the **Phone Call** icon and `Phone Call`.

- The green LED blinks.
- Your radio unmutes and the incoming call sounds through the speaker.

1 Press the **PTT** button to respond to the call.

2 Release the **PTT** button to listen.

3 Press  to end the call.



NOTICE:

Your radio is not able to terminate a phone call as a group call. The telephone user must end the call. The recipient user is only allowed to talk back during the call.

The display shows `Ending Phone Call`.

If the call ends successfully:

- A tone sounds.
- The display shows `Call Ended`.

If the call fails to end, the radio returns to the Phone Call screen. Repeat [step 3](#) or wait for the telephone user to end the call.

Responding to Phone Calls as Private Calls

Follow the procedure to respond to Phone Calls as Private Calls on your radio.

When you receive a Phone Call as a Private Call:

- The display shows the **Phone Call** icon and Phone Call.
- The green LED blinks.
- Your radio unmutes and the incoming call sounds through the speaker.

1 Press the **PTT** button to respond to the call.

2 Release the **PTT** button to listen.

3 Press  to end the call.



NOTICE:

Your radio is not able to terminate a phone call as a group call. The telephone user must end the call. The recipient user is only allowed to talk back during the call.

The display shows Ending Phone Call.

If the call ends successfully:

- A tone sounds.
- The display shows Call Ended.

If the call fails to end, the radio returns to the Phone Call screen. Repeat [step 3](#) or wait for the telephone user to end the call.

Call Preemption

Call Preemption allows a radio to stop any in-progress voice transmission and initiate a priority transmission.

With the Call Preemption feature, the system interrupts and preempts ongoing calls in instances where trunked channels are unavailable.

Higher priority calls such as an Emergency Call or an All Call preempt the transmitting radio to accommodate the higher priority call. If no other Radio Frequency (RF) channels are available, an Emergency Call preempts an All Call as well.

Voice Interrupt

Voice Interrupt allows the user to shut down an in-progress voice transmission.

This feature uses reverse channel signaling to stop the in-progress voice transmission of a radio, if the interrupting radio is configured to Voice Interrupt, and the transmitting radio is configured to be Voice Call Interruptible. The interrupting radio is then allowed to make a voice transmission to the participant in the stopped call.

The Voice Interrupt feature significantly improves the probability of successfully delivering a new transmission to the intended parties when a call is in progress.

Voice Interrupt is accessible to the user only if this feature has been set up in the radio. Check with your dealer or system administrator for more information.

Enabling Voice Interrupt

Follow the procedure to initiate Voice Interrupt on your radio.

Your radio must be programmed to allow you to use this feature. Check with your dealer or system administrator for more information.

- 1 To interrupt the transmission during an on-going call, press the **PTT** button.

On the interrupted radio, the display shows **Call Interrupted**. The radio sounds a negative indicator tone until the **PTT** button is released.

- 2 Wait for acknowledgment.

If successful:

- A positive indicator tone sounds.

If unsuccessful:

- A negative indicator tone sounds.
-

- 3 Do one of the following:

- Wait for the Talk Permit Tone to end and speak clearly into the microphone if enabled.
 - Wait for the **PTT** Sidetone to end and speak clearly into the microphone if enabled.
-

Advanced Features

This chapter explains the operations of the features available in your radio.

Your dealer or system administrator may have customized your radio for your specific needs. Check with your dealer or system administrator for more information.

Call Queue

When there are no resources available to process a call, Call Queue enables the call request to be placed in the system queue for the next available resources.

You hear a Call Queue Tone after pressing the **PTT** button and radio screen displays `Call In Queue` indicating that the radio has entered Call Queue State. The **PTT** button may be released once the Call Queue Tone is heard.

If the call setup is successful, the following occur:

- The green LED blinks.
- If enabled, the Talk Permit Tone sounds.
- The display shows the call type icon, ID or alias.
- The radio user has up to 4 seconds to press the **PTT** button to begin voice transmission.

If the call setup is unsuccessful, the following occur:

- If enabled, the Reject Tone sounds.
- The display shows the failure notice screen momentarily.
- The call is terminated and the radio exits the call setup.

Priority Call

Priority Call allows the system to preempt one of the ongoing non-priority calls and initiate the requested high priority call when all channels are busy.

With all channels occupied with high priority calls, the system does not preempt any calls, and places the requesting high-priority call into call queue. If the system fails to place the requesting high-priority call into call queue, it declares failure.

The default settings for Priority Call are preconfigured. Press the programmable button to toggle between normal and high priority level. When you use the following features, the call priority level reverts automatically to the preconfigured setting.

- All voice calls
- DMR III Text Message/Text Message

- Job Ticket
- Remote monitor

**NOTICE:**

Check with your dealer or system administrator to determine how your radio has been programmed.

The following are the types of Priority Call:

High Priority

The radio displays Next Call: High Priority.

Call Priority High icon appears at the top of your radio display.

Voice Announcement sounds Next Call: High Priority.

Normal Priority

The radio displays Next Call: Normal Priority.

Call Priority High icon disappears.

Voice Announcement sounds Next Call: Normal Priority.

Talkgroup Scan

This feature allows your radio to monitor and join calls for groups defined by a Receive Group List.

When scan is enabled, the scan icon appears on the status bar and the LED blinks yellow. Your radio unmutes to any member in its Receive Group List.

When scan is disabled, your radio does not receive transmission from any members of the Receive Group List, except for All Call and the selected Talkgroup.



**NOTICE:**



Talkgroup Scan can be configured by using CPS. Check with your system administrator to determine how your radio has been programmed.



Turning Talkgroup Scan On or Off

Follow the procedure to turn Talkgroup Scan on or off on your radio.

- 1 Press  to access the menu.

- 2 Press  or  to Scan. Press  to select.

- 3 Do one of the following:
 - Press  or  to Turn On. Press  to select.

- Press  or  to Turn Off. Press  to select.
-

If scan is enabled:

- The display shows **Scan On** and **Scan** icon.
- The yellow LED blinks.
- A positive indicator tone sounds.

If scan is disabled:

- The display shows **Scan Off**.
- The **Scan** icon disappears.
- The LED turns off.
- A negative indicator tone sounds.

Receive Group List

Receive Group List is a feature that allows you to create and assign members on the talkgroup scan list.

This list is created when your radio is programmed and it determines which groups can be scanned. Your radio can support a maximum of 16 members in this list.

If your radio has been programmed to edit the scan list, you can:

- Add/remove talkgroups.
- Add, remove, and/or edit priority for talkgroups. Refer to [Editing Priority for a Talkgroup on page 99](#).
- Add, remove, and/or edit affiliation talkgroups. Refer to [Adding Talkgroup Affiliation on page 100](#) and [Removing Talkgroup Affiliation on page 101](#).
- Replace the existing scan list with a new scan list.



IMPORTANT:

To add member into the list, the talkgroup must first be configured in the radio.



NOTICE:

Receive Group List is programmed by the system administrator. Check with your dealer or system administrator for more information.

Priority Monitor

The Priority Monitor feature allows the radio to automatically receive transmission from talkgroups with higher priority even when radio is in a talkgroup call.

Radio leaves lower priority talkgroup call for higher priority talkgroup call.

**NOTICE:**

This feature can only be accessed when Talkgroup Scan feature is enabled.

Priority Monitor feature applies only to members in the Receive Group List. There are two Priority Talkgroups: Priority 1 (P1) and Priority 2 (P2). P1 has higher priority than P2. In Capacity Max system, the radio receives transmission according to the priority order below:

- 1 Emergency Call for P1 Talkgroup
- 2 Emergency Call for P2 Talkgroup
- 3 Emergency Call for non-priority Talkgroups in the Receive Group List
- 4 All Call
- 5 P1 Talkgroup Call
- 6 P2 Talkgroup Call
- 7 Non-priority Talkgroups in the Receive Group List

See [Editing Priority for a Talkgroup on page 99](#) for more information on how to add, remove, and/or edit the priority of the talkgroups in the scan list.



**NOTICE:**



This feature is programmed by the system administrator. Check with your dealer or system administrator for more information.



Editing Priority for a Talkgroup

In the Talkgroup Scan Menu, you can view or edit the priority of a talkgroup.



- 1 Press  to access the menu.



- 2 Press  or  to Scan. Press  to select.

- 3 Press  or  to View/Edit List. Press  to select.

- 4 Press  or  to the required talkgroup. Press  to select.

The current priority is indicated by a **Priority 1** or **Priority 2** icon beside the talkgroup.

5 Press  or  to Edit Priority. Press  to select.

6 Press  or  to the required priority level.
Press  to select.

If another talkgroup has been assigned to Priority 1 or Priority 2, you can choose to overwrite the current priority. When the display shows Overwrite

Existing?, press  or  to the following options:

- No to return to the previous step.
- Yes to overwrite.

The display shows positive mini notice before returning to the previous screen. The priority icon appears beside the talkgroup.

Multi-Talkgroup Affiliation

In a Capacity Max system, your radio can be configured for up to seven talkgroups at a site.

Of the 16 talkgroups in the Receive Group List, up to seven talkgroups can be assigned as affiliation talkgroups. The selected talkgroup and the priority talkgroups are automatically affiliated.













NOTICE:



This feature is programmed by the system administrator. Check with your dealer or system administrator for more information.

Adding Talkgroup Affiliation







Follow the procedure to add a talkgroup affiliation.

- 1 Press  to access the menu.
- 2 Press  or  to Scan. Press  to select.
- 3 Press  or  to View/Edit List. Press  to select.
- 4 Press  or  to the required talkgroup ID or alias. Press  to select.

The affiliation status is displayed at the *View/Edit List*. The display shows  beside the selected talkgroup ID or alias.

-
- 5 Press  or  to *Edit Affiliation*. Press  to select.

-
- 6 Do one of the following:

- Press  or  to *On*. Press  to select.
- Press  or  to *Off*. Press  to select.

When *On* is selected,  appears beside the talkgroup ID or alias.

If affiliation is successful, the display shows  beside the selected talkgroup ID or alias.

If affiliation is unsuccessful,  remains beside the talkgroup ID or alias.













NOTICE:

The radio displays *List Full* when a maximum of seven talkgroups are selected for affiliation in the scan list. To select a new talkgroup for affiliation, remove an existing affiliated talkgroup to make way for the new addition. See [Removing Talkgroup Affiliation on page 101](#) for more information.



Removing Talkgroup Affiliation





When the affiliation list is full and you want to select a new talkgroup for affiliation, remove an existing affiliated talkgroup to make way for the new addition. Follow the procedure to remove a talkgroup affiliation.

- 1 Press  to access the menu.
-
- 2 Press  or  to *Scan*. Press  to select.
-
- 3 Press  or  to *View/Edit List*. Press  to select.
-

- 4 Press  or  to the required talkgroup ID or alias. Press  to select.

The affiliation status is displayed at the *View/Edit List*. The display shows  beside the selected talkgroup ID or alias.

- 5 Press  or  to *Edit Affiliation*. Press  to select.
-

- 6 Press  or  to *Off*. Press  to select.
- When *Off* is selected,  disappears from beside the talkgroup ID or alias.
-

Talkback

The Talkback feature allows you to respond to a transmission while scanning.

If your radio scans into a call from the selectable group scan list, and if the **PTT** button is pressed during the scanned call, the operation of the radio depends on whether Talkback was enabled or disabled during radio

programming. Check with your dealer or system administrator for more information.

Talkback Disabled

The radio leaves the scanned call and attempts to transmit on the contact for the currently selected channel position. After the Call Hang Time on the currently selected contact expires, the radio returns to the home channel and starts the Scan Hang Time Timer. The radio resumes group scan after its Scan Hang Time expires.

Talkback Enabled

If the **PTT** button is pressed during the Group Hang Time of the scanned call, the radio attempts to transmit to the scanned group.



NOTICE:

If you scan into a call for a group that is not assigned to a channel position in the currently selected zone and the call ends, switch to the proper zone and then select the channel position of the group to talk back to that group.

Bluetooth

This feature allows you to use your radio with a Bluetooth-enabled device (accessory) through a Bluetooth

connection. Your radio supports both Motorola Solutions and Commercially available Off-The-Shelf (COTS) Bluetooth-enabled devices.

Bluetooth operates within a range of 10 m (32 ft) line of sight. This is an unobstructed path between your radio and your Bluetooth-enabled device. For high degree of reliability, Motorola Solutions recommends to not separate the radio and the accessory.

At the fringe areas of reception, both voice and tone quality start to sound "garbled" or "broken". To correct this problem, position your radio and Bluetooth-enabled device closer to each other (within the 10 m defined range) to re-establish clear audio reception. The Bluetooth function of your radio has maximum power of 2.5 mW (4 dBm) at the 10 m range.

Your radio can support up to three simultaneous Bluetooth connections with Bluetooth-enabled devices of unique types. For example, a headset, a scanner, and a PTT-Only Device (POD). Multiple connections with Bluetooth-enabled devices of the same type are not supported.

Refer to the user manual of your respective Bluetooth-enabled device for more details on the full capabilities of your Bluetooth-enabled device.







NOTICE:





If disabled through CPS, all Bluetooth-related features are disabled and the Bluetooth device database is erased.





Turning Bluetooth On and Off





Follow the procedure to turn Bluetooth on and off.

- 1 Press  to access the menu.

- 2 Press  or  to Bluetooth. Press  to select.

- 3 Press  or  to My Status. Press  to select.
The display shows On and Off. The current status is indicated by a .

- 4 Do one of the following:
 - Press  or  to On. Press  to select.
The display shows  beside On.



- Press  or  to Off. Press  to select. The display shows  beside Off.
-



Connecting to Bluetooth Devices



Follow the procedure to connect to Bluetooth devices.

Turn on your Bluetooth-enabled device and place it in pairing mode.

- 1 Press  to access the menu.

- 2 Press  or  to Bluetooth. Press  to select.

- 3 Press  or  to Devices. Press  to select.

- 4 Do one of the following:
 - Press  or  to the required device. Press  to select.

- Press  or  to Find Devices to locate available devices. Press  or  to the required device. Press  to select.
-

- 5 Press  or  to Connect. Press  to select.

Your Bluetooth-enabled device may require additional steps to complete the pairing. Refer to the user manual of your Bluetooth-enabled device.

The display shows Connecting to <Device>.

Wait for acknowledgment.

If successful:

- A positive indicator tone sounds.
- The display shows <Device> Connected and the **Bluetooth Connected** icon.
- The display shows  beside the connected device.

If unsuccessful:

- A negative indicator tone sounds.
- The display shows Connecting Failed.

**NOTICE:**



If pin code is required, see [Accessing Radios by Using Passwords on page 178](#).



Connecting to Bluetooth Devices in Discoverable Mode

Follow the procedure to connect to Bluetooth devices in discoverable mode.

Turn on your Bluetooth-enabled device and place it in pairing mode.

- 1 Press  to access the menu.

- 2 Press  or  to Bluetooth. Press  to select.

- 3 Press  or  to Find Me. Press  to select. The radio can now be found by other Bluetooth-enabled devices for a programmed duration. This is called Discoverable Mode.

Wait for acknowledgment.

If successful:

- A positive indicator tone sounds.
- The display shows <Device> Connected and the **Bluetooth Connected** icon.
- The display shows  beside the connected device.



If unsuccessful:



- A negative indicator tone sounds.
- The display shows Connecting Failed.



Disconnecting from Bluetooth Devices



Follow the procedure to disconnect from Bluetooth devices.

- 1 Press  to access the menu.

- 2 Press  or  to Bluetooth. Press  to select.

- 3 Press  or  to Devices. Press  to select.

- 4 Press  or  to the required device. Press  to select.

- 5 Press  or  to Disconnect. Press  to select.

The display shows Disconnecting from <Device>.



NOTICE:

Your Bluetooth-enabled device may require additional steps to disconnect. Refer to respective user manuals of any Bluetooth-enabled devices.

Wait for acknowledgment.

- A tone sounds.
- The display shows <Device> Disconnected and the **Bluetooth Connected** icon disappears.
- The  disappears beside the connected device.

Switching Audio Route between Internal Radio Speaker and Bluetooth Device

Follow the procedure to toggle audio routing between internal radio speaker and external Bluetooth device.

Press the programmed **Bluetooth Audio Switch** button.



The display shows one of the following results:



- A tone sounds. The display shows Route Audio to Radio.
- A tone sounds. The display shows Route Audio to Bluetooth.



Viewing Device Details



Follow the procedure to view device details on your radio.

- 1 Press  to access the menu.

2 Press  or  to Bluetooth. Press  to select.

3 Press  or  to Devices. Press  to select.



4 Press  or  to the required device. Press  to select.



5 Press  or  to View Details. Press  to select.



Deleting Device Name



You can remove a disconnected device from the list of Bluetooth-enabled devices.

1 Press  to access the menu.

2 Press  or  to Bluetooth. Press  to select.

3 Press  or  to Devices. Press  to select.



4 Press  or  to the required device. Press  to select.



5 Press  or  to Delete. Press  to select. The display shows Device Deleted.



Bluetooth Mic Gain



This feature allows the user to control the microphone gain value of the connected Bluetooth-enabled device.

1 Press  to access the menu.

2 Press  or  to Bluetooth. Press  to select.

3 Press  or  to BT Mic Gain. Press  to select.

4 Press  or  to the BT Mic Gain type and the current values. Press  to select. You can edit the values here.

5 Press  or  to increase or to decrease values. Press  to select.

Indoor Location











NOTICE:

Indoor Location feature is applicable for models with the latest software and hardware. Check with your dealer or system administrator for more information.

Indoor Location is be used to keep track of the location of radio users. When Indoor Location is activated, the radio is in a limited discoverable mode. Dedicated beacons are used to locate the radio and determine its position.

Turning Indoor Location On or Off

You can turn on or turn off Indoor Location by performing one of the following actions.

- Access this feature through the menu.
 - a. Press  to access the menu.
 - b. Press  or  to Bluetooth and press  to select.
 - c. Press  or  to Indoor Location and press  to select.
 - d. Press  to turn on Indoor Location.

The display shows Indoor Location On. You hear a positive indicator tone.

One of the following scenarios occurs.

- If successful, the Indoor Location Available icon appears on the Home screen display.

- If unsuccessful, the display shows **Turning On Failed**. You hear a negative indicator tone.

e. Press  to turn off Indoor Location.

The display shows **Indoor Location Off**. You hear a positive indicator tone.

One of the following scenarios occurs.

- If successful, the Indoor Location Available icon disappears on the Home screen display.
- If unsuccessful, the display shows **Turning Off Failed**. You hear a negative indicator tone.

- Access this feature by using the programmed button.

a. Long press the programmed **Indoor Location** button to turn on Indoor Location.

The display shows **Indoor Location On**. You hear a positive indicator tone.

One of the following scenarios occurs.

- If successful, the Indoor Location Available icon appears on the Home screen display.

- If unsuccessful, the display shows **Turning On Failed**. If unsuccessful, you hear a negative indicator tone.

b. Press the programmed **Indoor Location** button to turn off Indoor Location.

The display shows **Indoor Location Off**. You hear a positive indicator tone.



One of the following scenarios occurs.



- If successful, the Indoor Location Available icon disappears on the Home screen display.
- If unsuccessful, the display shows **Turning Off Failed**. If unsuccessful, you hear a negative indicator tone.



Accessing Indoor Location Beacons Information

Follow the procedure to access Indoor Location beacons information.

- 1 Press  to access the menu.

2 Press  or  to Bluetooth and press  to select.

3 Press  or  to Indoor Location and press  to select.

4 Press  or  to Beacons and press  to select.

The display shows the beacons information.

Multi-Site Controls

These features are applicable when your current radio channel is configured to a Capacity Max system.

Starting Manual Site Search

Follow the procedure to start manual site search when the received signal strength is poor in order to attempt to find a site with better signal.

If the radio finds a new site:

- A positive indicator tone sounds.
- If the radio fails to find a new site:
- A negative indicator tone sounds.

Site Lock On/Off

When toggled on, the radio searches the current site only. When toggled off, the radio searches other sites in addition to the current site.

Press the programmed **Site Lock** button.

If the **Site Lock** function is toggled on:

- You hear a positive indicator tone, indicating the radio has locked to the current site.
- The display shows `Site Locked`.



If the **Site Lock** function is toggled off:



- You hear a negative indicator tone, indicating the radio is unlocked.
 - The display shows `Site Unlocked`.
-



Accessing Neighbor Sites List

This feature allows the user to check the adjacent sites list of the current home site. Follow the procedure to access the Neighbor Sites List:

- 1 Press  to access the menu.

- 2 Press  or  to Utilities. Press  to select.

- 3 Press  or  to Radio Info. Press  to select.

- 4 Press  or  to Neighbor Sites. Press  to select.

Home Channel Reminder

This feature provides a reminder when the radio is not set to the home channel for a period of time.

If this feature is enabled when your radio is not set to the home channel for a period of time, the following occurs periodically:

- The Home Channel Reminder tone and announcement sound.
- The first line of the display shows Non.
- The second line shows Home Channel.

Muting the Home Channel Reminder

When the Home Channel Reminder sounds, you can temporarily mute the reminder.

Press the **Silence Home Channel Reminder** programmable button.

The first line of the display shows HCR and the second line shows Silenced.



Setting New Home Channels



When the Home Channel Reminder occurs, you can set a new home channel.



- 1 Do one of the following:





- Press the **Reset Home Channel** programmable button to set the current channel as the new Home Channel. Skip the following steps. The first line of the display shows the channel alias and the second line shows `New Home Ch.`

- Press  to access the menu.

2 Press  or  to `Utilities`. Press  to select.

3 Press  or  to `Radio Settings`. Press  to select.

4 Press  or  to `Home Channel`. Press  to select.

5 Press  or  to the desired new home channel alias. Press  to select.
The display shows  beside the selected home channel alias.

Remote Monitor

This feature is used to turn on the microphone of a target radio with a subscriber alias or ID. You can use this feature to remotely monitor any audible activity surrounding the target radio.



Both your radio and the target radio must be programmed to allow you to use this feature.

If initiated, the green LED blinks once on the target radio. This feature automatically stops after a programmed duration or when there is any user operation on the target radio.

Initiating Remote Monitor

Follow the procedure to initiate Remote Monitor on your radio.











- 1 Press the programmed **Remote Monitor** button.
-

- 2 Press  or  to the required alias or ID.
Press  to select.
The display shows a transitional mini notice, indicating the request is in progress. The green LED lights up.
-

- 3 Wait for acknowledgment.
If successful:
- A positive indicator tone sounds.
 - The display shows a positive mini notice.
 - The audio from the monitored radio starts playing for a programmed duration, and the display shows *Rem. Monitor*. Once the timer expires, an alert tone sounds, and the LED turns off.
- If unsuccessful:
- A negative indicator tone sounds.
 - The display shows a negative mini notice.
-

Initiating Remote Monitor by Using the Contacts List

Follow the procedure to initiate Remote Monitor on your radio by using the Contacts list.

- 1 Press  to access the menu.
-
- 2 Press  or  to *Contacts*. Press  to select.
-
- 3 Press  or  to the required alias or ID.
Press  to select.
-
- 4 Press  or  to *Remote Mon.*. Press  to select.
The display shows a transitional mini notice, indicating the request is in progress. The green LED lights up.
-
- 5 Wait for acknowledgment.
If successful:





- A positive indicator tone sounds.
- The display shows a positive mini notice.
- The audio from the monitored radio starts playing for a programmed duration, and the display shows Rem. Monitor. Once the timer expires, an alert tone sounds, and the LED turns off.



If unsuccessful:



- A negative indicator tone sounds.
- The display shows a negative mini notice.

Initiating Remote Monitors by Using the Manual Dial



Follow the procedure to initiate Remote Monitor on your radio by using the manual dial.

- 1 Press  to access the menu.
-
- 2 Press  or  to Contacts. Press  to select.
-

- 3 Press  or  to Manual Dial. Press  to select.
-

- 4 Press  or  to Radio Number. Press  to select.
-

- 5 Do one of the following:

- Enter the subscriber alias or ID, and press  to proceed.
 - Edit the previously dialed ID, and press  to proceed.
-

- 6 Press  or  to Remote Mon.. Press  to select.

The display shows a transitional mini notice, indicating the request is in progress. The green LED lights up.

- 7 Wait for acknowledgment.

If successful:

- A positive indicator tone sounds.

- The display shows a positive mini notice.
- The audio from the monitored radio starts playing for a programmed duration, and the display shows *Rem. Monitor*. Once the timer expires, an alert tone sounds, and the LED turns off.

If unsuccessful:

- A negative indicator tone sounds.
- The display shows a negative mini notice.

Contacts Settings

Contacts provides address book capabilities on your radio. Each entry corresponds to an alias or ID that you use to initiate a call. The entries are alphabetically sorted.

Each entry, depending on context, associates with the different call types: Group Call, Private Call, Broadcast Call, Site All Call, Multi-site All Call, PC Call, or Dispatch Call.

PC Call and Dispatch Call are data-related. They are only available with the applications. Refer to the data applications documentation for further details.

Additionally, Contacts menu allows you to assign each entry to a programmable number key or more on a keypad

microphone. If an entry is assigned to a number key, your radio can perform a quick dial on the entry.



NOTICE:

You see a checkmark before each number key that is assigned to an entry. If the checkmark is before *Empty*, you have not assign a number key to the entry.

Each entry within Contacts displays the following information:

- Call Type
- Call Alias
- Call ID







NOTICE:



If the Privacy feature is enabled on a channel, you can make privacy-enabled Group Calls, Private Calls, All Calls, and Phone Calls on that channel. Only target radios with the same Privacy Key, or the same Key Value and Key ID as your radio will be able to decrypt the transmission.



Assigning Entries to Programmable Number Keys



Follow the procedure to assign entries to programmable number keys on your radio.

- 1 Press  to access the menu.



- 2 Press  or  to `Contacts`. Press  to select.

- 3 Press  or  to the required alias or ID.
Press  to select.



- 4 Press  or  to `Program Key`. Press  to select.



- 5 Do one of the following:
 - If the desired number key has not been assigned to an entry, press  or  to the desired number key. Press  to select.

- If the desired number key has been assigned to an entry, the display shows `The Key is Already Assigned` and then, the first text line shows `Overwrite?`. Do one of the following:

Press  or  to `Yes`. Press  to select.

The radio sounds a positive indicator tone and the display shows `Contact Saved` and a positive mini notice.

Press  or  to `No` to return to the previous step.

Each entry can be associated to different number keys. You see a  before each number key that is assigned to an entry. If the  is before `Empty`, that number key is not assigned.



If a number key is assigned to an entry in a particular mode, this feature is not supported when you long press the number key in another mode.



The screen automatically returns to the previous menu.

Removing Associations Between Entries and Programmable Number Keys



Follow the procedure to remove the associations between entries and programmable number keys on your radio.



- 1 Do one of the following:
 - Long press the programmed number key to the required alias or ID. Proceed to [step 4](#).
 - Press  to access the menu.

- 2 Press  or  to Contacts. Press  to select.

- 3 Press  or  to the required alias or ID.
Press  to select.

- 4 Press  or  to Program Key. Press  to select.

- 5 Press  or  to Empty. Press  to select.
The first text line shows Clear from all keys.

- 6 Press  or  to Yes. Press  to select.



NOTICE:

When an entry is deleted, the association between the entry and its programmed number key(s) is removed.



A positive indicator tone sounds. The display shows Contact Saved.



The screen automatically returns to the previous menu.



Adding New Contacts

Follow the procedure to add new contacts on your radio.

- 1 Press  to access the menu.



- 2 Press  or  to **Contacts**. Press  to select.

- 3 Press  or  to **New Contact**. Press  to select.

- 4 Press  or  to select contact type **Radio Contact** or **Phone Contact**. Press  to select.

- 5 Enter the contact number with the keypad, and press  to proceed.

- 6 Enter the contact name with the keypad, and press  to proceed.

- 7 Press  or  to the required ringer type. Press  to select.

A positive indicator tone sounds. The display shows a positive mini notice.



Call Indicator Settings



This feature allows the radio users to configure call or text message ringing tones.



Activating or Deactivating Call Ringers for Private Calls



Follow the procedure to activate or deactivate call ringers for Private Calls on your radio.



- 1 Press  to access the menu.



- 2 Press  or  to **Utilities**. Press  to select.

- 3 Press  or  to **Radio Settings**. Press  to select.

- 4 Press  or  to **Tones/Alerts**. Press  to select.

5 Press  or  to Call Ringers. Press  to select.

6 Press  or  to Private Call. Press  to select.



7 Press  or  to the required tone. Press  to select.

If enabled, ✓ appears beside Enabled. If disabled, ✓ disappears beside Enabled.



Activating or Deactivating Call Ringers for Text Messages



Follow the procedure to activate or deactivate call ringers for text messages on your radio.



1 Press  to access the menu.



2 Press  or  to Utilities. Press  to select.

3 Press  or  to Radio Settings. Press  to select.

4 Press  or  to Tones/Alerts. Press  to select.

5 Press  or  to Call Ringers. Press  to select.



6 Press  or  to Text Message. Press  to select.
The display shows ✓ and the current tone.



7 Press  or  to the required tone. Press  to select. The display shows ✓ beside the selected tone.



Activating or Deactivating Call Ringers for Call Alerts



Follow the procedure to activate or deactivate call ringers for Call Alerts on your radio.



- 1 Press  to access the menu.

- 2 Press  or  to Utilities. Press  to select.

- 3 Press  or  to Radio Settings. Press  to select.

- 4 Press  or  to Tones/Alert. Press  to select.

- 5 Press  or  to Call Ringers. Press  to select.



- 6 Press  or  to Call Alert. Press  to select.



- 7 Press  or  to the required tone. Press  to select. The display shows ✓ beside the selected tone.
-



Activating or Deactivating Call Ringers for Selective Calls



Follow the procedure to activate or deactivate call ringers for Selective Calls on your radio.



- 1 Press  to access the menu.

- 2 Press  or  to Utilities. Press  to select.





- 3 Press  or  to Radio Settings. Press  to select.

- 4 Press  or  to Tones/Alerts. Press  to select.

5 Press  or  to Call Ringers. Press  to select.

6 Press  or  to Selective Call. Press  to select.



The display shows  and the current tone.

7 Press  or  to the required tone. Press  to select. The display shows  beside the selected tone.



Activating or Deactivating Call Ringers for Telemetry Status with Text



Follow the procedure to activate or deactivate call ringers for telemetry status with text on your radio.



1 Press  to access the menu.

2 Press  or  to Utilities. Press  to select.

3 Press  or  to Radio Settings. Press  to select.

4 Press  or  to Tones/Alert. Press  to select.

5 Press  or  to Call Ringers. Press  to select.

6 Press  or  to Telemetry. Press  to select.



The current tone is indicated by a .



Assigning Ring Styles



The radio can be programmed to sound one of eleven predefined ringing tones when receiving a Private Call, a Call Alert, or a Text Message from a particular contact. The



radio sounds out each ring style as you navigate through the list. Follow the procedure to assign ring styles on your radio.





- 1 Press  to access the menu.

- 2 Press  or  to **Contacts**. Press  to select.
The entries are alphabetically sorted.

- 3 Press  or  to the required alias or ID.
Press  to select.

- 4 Press  or  to **View/Edit**. Press  to select.

- 5 Press  until display shows **Ringer** menu
A  indicates the current selected tone.

- 6 Press  or  to the required tone. Press  to select.
A  appears beside the selected tone.
-

Escalating Alarm Tone Volume

The radio can be programmed to continually alert, when a radio call remains unanswered. This is done by automatically increasing the alarm tone volume over time. This feature is known as Escalart.

Call Log Features

Your radio keeps track of all recent outgoing, answered, and missed Private Calls. The call log feature is used to view and manage recent calls.

Missed Call Alerts may be included in the call logs, depending on the system configuration on your radio. You can perform the following tasks in each of your call lists:



- Store Alias or ID to Contacts
- Delete Call



- Delete All Calls
- View Details

Viewing Recent Calls

Follow the procedure to view recent calls on your radio.



- 1 Press  to access the menu.

- 2 Press  or  to Call Log. Press  to select.

- 3 Press  or  to the preferred list. The options are Missed, Answered, and Outgoing lists.

Press  to select.

The display shows the most recent entry.



- 4 Press  or  to view the list.



You can start a call with the alias or ID the display is currently showing by pressing the **PTT** button.



Storing Aliases or IDs from the Call List

Follow the procedure to store aliases or IDs on your radio from the Call list.



- 1 Press  to access the menu.

- 2 Press  or  to Call Log. Press  to select.

- 3 Press  or  to the required list. Press  to select.

- 4 Press  or  to the required alias or ID.

Press  to select.

- 5 Press  or  to Store. Press  to select.

The display shows a blinking cursor.







- 6 Enter the rest of the characters of the required alias.



Press  to select.



You can store an ID without an alias.
The display shows a positive mini notice.





Deleting Calls from the Call List

Follow the procedure to delete calls on your radio from the Call list.

- 1 Press  to access the menu.
 - 2 Press  or  to Call Log. Press  to select.
 - 3 Press  or  to the required list. Press  to select.
If the list is empty:
 - A tone sounds.
 - The display shows `List Empty`.
-

- 4 Press  or  to the required alias or ID.
Press  to select.
-



- 5 Press  or  to Delete Entry?. Press  to select.
-



- 6 Do one of the following:
 - Press  to select Yes to delete the entry.
The display shows `Entry Deleted`.
 - Press  or  to No. Press  to select.
The radio returns to the previous screen.
-



Deleting All Calls from the Call List



Follow the procedure to delete all calls on your radio from the Call list.





- 1 Press  to access the menu.
-

- 2 Press  or  to Call Log. Press  to select.

- 3 Press  or  to the required list. Press  to select.

- 4 Press  or  to the required alias or ID.
Press  to select.



- 5 Press  or  to Delete All. Press  to select.



- 6 Do one of the following:
 - Press  to select Yes to delete all entries. The display shows a positive mini notice.
 - Press  or  to No. Press  to select. The radio returns to the previous screen.



Viewing Details from the Call List



Follow the procedure to view details on your radio from the Call list.

- 1 Press  to access the menu.

- 2 Press  or  to Call Log. Press  to select.

- 3 Press  or  to the required list. Press  to select.

- 4 Press  or  to the required alias or ID.
Press  to select.

- 5 Press  or  to View Details. Press  to select.
The display shows the details.

Call Alert Operation

Call Alert paging enables you to alert a specific radio user to call you back when they are able to do so.

This feature is applicable for subscriber aliases or IDs only and is accessible through the menu by using Contacts, manual dial, or a programmed **One Touch Access** button.

In Capacity Max, the Call Alert feature allows a radio user or a dispatcher to send an alert to another radio user requesting the radio user to call back the initiating radio user when available. Voice communication is not involved in this feature.

The Call Alert Operation can be configured by the dealer or the system administrator in two ways:

- The radio is configured to allow the user to press the **PTT** button to respond directly to the call initiator by making a Private Call.
- The radio is configured to allow the user to press the **PTT** button and continue with other Talkgroup communication. Pressing the **PTT** button on the call alert entry will not allow the user to respond to the call initiator. The user must navigate to the Missed Call Log option at the Call Log menu and respond to the Call Alert from there.

An Off Air Call Set-Up (OACSU) private call allows the user to respond immediately while a Full Off Air Call Set-Up (FOACSU) private call requires user acknowledgment for the call. OACSU type calls are therefore, recommended being used for the call alert feature. See [Private Call on page 71](#).

Making Call Alerts

Follow the procedure to make Call Alerts on your radio.

- 1 Press the programmed **One Touch Access** button.

The display shows `Call Alert` and the subscriber alias or ID. The green LED lights up.

- 2 Wait for acknowledgment.



If the Call Alert acknowledgment is received, the display shows a positive mini notice.



If the Call Alert acknowledgment is not received, the display shows a negative mini notice.



Making Call Alerts by Using the Contacts List

Follow the procedure to make Call Alerts on your radio by using the Contacts list.

- 1 Press  to access the menu.

- 2 Press  or  to **Contacts**. Press  to select.

- 3 Press  or  to the required alias or ID.
Press  to select.

- 4 Press  or  to **Call Alert**. Press  to select.
The display shows **Call Alert** and the subscriber alias or ID. The green LED lights up.

- 5 Wait for acknowledgment.
 - If the Call Alert acknowledgment is received, the display shows a positive mini notice.

- If the Call Alert acknowledgment is not received, the display shows a negative mini notice.

Responding to Call Alerts

Follow the procedure to respond to Call Alerts on your radio.

When you receive a Call Alert:

- A repetitive tone sounds.
- The yellow LED blinks.
- The display shows the notification list listing a Call Alert with the alias or ID of the calling radio.

Depending on the configuration by your dealer or system administrator, you can respond to a Call Alert by doing one of the following:

- Press the **PTT** button and respond with a Private Call directly to the caller.
- Press the **PTT** button to continue normal talkgroup communication.

The Call Alert is moved to the Missed Call option at the Call Log menu. You can respond to the caller from the Missed Called log.

See [Notification List on page 181](#) and [Call Log Features on page 122](#) for more information.

Mute Mode

Mute Mode provides an option to the user to silence all audio indicators of the radio.

Once Mute Mode feature is initiated, all audio indicators are muted except higher priority features such as Emergency operations.

When Mute Mode is exited, the radio resumes playing ongoing tones and audio transmissions.



NOTICE:

This is a purchasable feature. Check with your dealer or system administrator for more information.

Turning On Mute Mode

Follow the procedure to turn on Mute Mode.

Access this feature by using the programmed **Mute Mode** button.

The following occurs when Mute mode is enabled:



- Positive Indicator Tone sounds.
- Display shows `Mute Mode On`.
- The red LED light starts blinking and remains blinking until Mute Mode is exited.
- Display shows **Mute Mode** icon on home screen.
- Radio is muted.
- Mute Mode Timer begins counting down the duration that is configured.



Setting Mute Mode Timer



Mute Mode feature can be enabled for a pre-configured amount of time by setting the Mute Mode Timer. The timer duration is configured in the radio menu and can range between 0.5–6 hours. Mute Mode is exited once the timer expires.



If the timer is left at 0, the radio remains in Mute mode for an indefinite period until the programmed **Mute Mode** button is pressed.

- 1 Press  to access the menu.

- 2 Press  or  to Utilities. Press  to select.

- 3 Press  or  to Radio Settings. Press  to select.

- 4 Press  or  to Mute Timer. Press  to select.

- 5 Press  or  to edit the numeric value of each digit, and press .

Do one of the following to exit Mute mode manually:

- Press the programmed **Mute Mode** button.
- Press the **PTT** button on any entry.

The following occurs when Mute mode is disabled:

- Negative Indicator Tone sounds.
- Display shows Mute Mode Off.
- The blinking red LED turns off.
- **Mute Mode** icon disappears from home screen.
- Your radio unmutes and speaker state is restored.
- If the timer has not expired, Mute mode timer is stopped.



NOTICE:

Mute Mode is also exited if the user transmits voice or switches to an unprogrammed channel.

Exiting Mute Mode

This feature can be exited automatically once the Mute Mode Timer expires.

Emergency Operation

An Emergency Alarm is used to indicate a critical situation. You are able to initiate an Emergency at any time even when there is activity on the current channel.

In Capacity Max, the receiving radio can only support a single Emergency Alarm at a time. If initiated, a second Emergency Alarm will override the first alarm.

When an Emergency Alarm is received, the recipient may choose to either delete the alarm and exit the Alarm List, or respond to the Emergency Alarm by pressing the **PTT** button and transmitting non-emergency voice.

Your dealer or system administrator can set the duration of a button press for the programmed **Emergency** button, except for long press, which is similar with all other buttons:

Short Press

Duration between 0.05 seconds and 0.75 seconds.

Long Press

Duration between 1.00 second and 3.75 seconds.

The **Emergency** button is assigned with the Emergency On/Off feature. Check with your dealer for the assigned operation of the **Emergency** button.



NOTICE:

If short press the **Emergency** button is assigned to turn on the Emergency mode, then long press the **Emergency** button is assigned to exit the Emergency mode.

If long press the **Emergency** button is assigned to turn on the Emergency mode, then short press the **Emergency** button is assigned to exit the Emergency mode.

Your radio supports three Emergency Alarms:

- Emergency Alarm
- Emergency Alarm with Call
- Emergency Alarm with Voice to Follow

In addition, each alarm has the following types:

Regular

Radio transmits an alarm signal and shows audio and/or visual indicators.

Silent

Radio transmits an alarm signal without any audio or visual indicators. Radio receives calls without any sound through the speaker, until the programmed *hot mic* transmission period is over and/or you press the **PTT** button.

Silent with Voice

Radio transmits an alarm signal without any audio or visual indicators, but allow incoming calls to sound through the speaker.



NOTICE:

Only one of the Emergency Alarms above can be assigned to the programmed **Emergency** button or the **Emergency** footswitch.

Sending Emergency Alarms

This feature allows you to send an Emergency Alarm, a non-voice signal, which triggers an alert indication on a group of radios. Follow the procedure to send Emergency Alarms on your radio.

Your radio does not display any audio or visual indicators during Emergency mode when it is set to Silent.

- 1 Press the programmed **Emergency On** button.

You see one of these results:

- The display shows Tx Alarms and the destination alias.
- The display shows Tx Telegram and the destination alias.

The green LED lights up. The **Emergency** icon appears.



NOTICE:

If programmed, the Emergency Search tone sounds. This tone is muted when the radio transmits or receives voice, and stops when the radio exits Emergency mode. The Emergency Search tone can be programmed by the dealer or system administrator.

-
- 2 Wait for acknowledgment.

If successful:

- The Emergency tone sounds.
- The green LED blinks.
- The display shows Alarm Sent.

If unsuccessful after all retries have been exhausted:

- A tone sounds.
- The display shows Alarm Failed.

The radio exits the Emergency Alarm mode and returns to the Home screen.



NOTICE:

When configured for Emergency Alarm only, the emergency process consists only of the Emergency Alarm delivery. The emergency ends when an acknowledgment is received from the system, or when channel access attempts have been exhausted.

No voice call is associated with the sending of an Emergency Alarm when operating as Emergency Alarm Only.

Sending Emergency Alarms with Call

This feature allows you to send an Emergency Alarm with Call to a group of radios or a dispatcher. Upon acknowledgment by the infrastructure within the group, a group of radios can communicate over a programmed Emergency channel.

The radio must be configured for Emergency Alarm and Call to perform an emergency call after the alarm process.

1 Press the programmed **Emergency On** button.

The display shows Tx Alarm and the destination alias. The **Emergency** icon appears. The green LED lights up.



NOTICE:

If programmed, the Emergency Search tone sounds. This tone is muted when the radio transmits or receives voice, and stops when the radio exits Emergency mode.

If an Emergency Alarm acknowledgment is successfully received:

- The Emergency tone sounds.
- The green LED blinks.
- The display shows Alarm Sent.
- Your radio enters the Emergency call mode when the display shows Emergency and the destination group alias.

If an Emergency Alarm acknowledgment is not successfully received:

- All retries are exhausted.
- A low-pitched tone sounds.
- The display shows Alarm Failed.

- The radio exits the Emergency Alarm mode.

2 Press the **PTT** button to initiate a voice transmission.

The green LED lights up. The display shows the **Group Call** icon.

3 Do one of the following:

- Wait for the Talk Permit Tone to end and speak clearly into the microphone if enabled.
 - Wait for the **PTT** Sidetone to end and speak clearly into the microphone if enabled.
-

4 Release the **PTT** button to listen.

The display shows the caller and group aliases.

- ## 5 If the Channel Free Indication feature is enabled, you hear a short alert tone the moment the transmitting radio releases the **PTT** button, indicating the channel is free for you to respond. Press the **PTT** button to respond to the call.
-

- ## 6 Press the **Emergency Off** button to exit the Emergency mode.

The radio returns to the Home screen.



NOTICE:

Depending on how your radio is programmed, you may or may not hear a Talk Permit tone. Your radio dealer or system administrator can provide more information on how your radio has been programmed for Emergency.

The Emergency Call initiator may press  to end an on-going emergency call. The radio returns to a call idle state but the emergency call screen remains open.

Sending Emergency Alarms with Voice to Follow

This feature allows you to send an Emergency Alarm with Voice to Follow to a group of radios. Your radio microphone is automatically activated, allowing you to communicate

with the group of radios without pressing the **PTT** button. This activated microphone state is also known as *hot mic*.



NOTICE:

Your radio cannot detect a non-IMPRES microphone that is attached to the rear accessory connector.

When no microphone is detected at the specified programmed connector, your radio checks the alternative connector. Here, your radio gives priority to the detected microphone.

If your radio has Emergency Cycle Mode enabled, repetitions of *hot mic* and receiving period are made for a programmed duration. During Emergency Cycle Mode, received calls sound through the speaker.

If you press the **PTT** button during the programmed receiving period, you hear a prohibit tone, indicating that you should release the **PTT** button. The radio ignores the **PTT** button press and remains in Emergency mode.

If you press the **PTT** button during *hot mic*, and continue to press it after the *hot mic* duration expires, the radio continues to transmit until you release the **PTT** button.

If the Emergency Alarm request fails, the radio does not retry to send the request, and enters the *hot mic* state directly.



NOTICE:

Some accessories may not support *hot mic*. Check with your dealer or system administrator for more information.

Follow the procedure to send Emergency Alarms with voice to follow on your radio.

- 1 Press the programmed **Emergency On** button or the **Emergency** footswitch.

You see one of these results:

- The display shows Tx Alarm and the destination alias.
- The display shows Tx Telegram and the destination alias.

The green LED lights up. The **Emergency** icon appears.

-
- 2 Once the display shows Alarm Sent, speak clearly into the microphone.

The radio automatically stops transmitting when:

- The cycling duration between *hot mic* and receiving calls expires, if Emergency Cycle Mode is enabled.

- The *hot mic* duration expires, if Emergency Cycle Mode is disabled.

3 Press the **Emergency Off** button to exit the Emergency mode.

The radio returns to the Home screen.

Receiving Emergency Alarms

The receiving radio can only support a single Emergency Alarm at a time. If initiated, a second Emergency Alarm will override the first alarm. Follow the procedure to receive and view Emergency Alarms on your radio.

When you receive an Emergency Alarm:

- A tone sounds.
- The red LED blinks.
- The display shows the Emergency Alarm List, the Emergency Talkgroup ID or alias, and the ID or alias of the transmitting radio.

1 Press  to view the alarm.

2 Press  to view the action options and details of the entry in the Alarm List.

3 Press  and select Yes to exit the Alarm list.

The radio returns to the home screen with an **Emergency Icon** displayed at the top, indicating the unresolved Emergency Alarm. The **Emergency Icon** disappears once the entry in the Alarm List is deleted.

4 Press  to access the menu.

5 Select `Alarm List` to revisit the Alarm list.



6 The tone sounds and the red LED blinks until you exit the Emergency mode. However, the tone can be silenced. Do one of the following:

- Press the **PTT** button to call the group of radios which received the Emergency Alarm.
 - Press any programmable button.
-

Responding to Emergency Alarms

When an Emergency Alarm is received, the recipient may choose to either delete the alarm and exit the Alarm List, or respond to the Emergency Alarm by pressing the **PTT** button and transmitting non-emergency voice. Follow the procedure to respond to Emergency Alarms on your radio.

- 1 If the Emergency Alarm Indication is enabled, the Emergency Alarm List appears when the radio

receives an Emergency Alarm. Press  or  to the required alias or ID.

- 2 If the Channel Free Indication feature is enabled, you hear a short alert tone the moment the transmitting radio releases the **PTT** button, indicating the channel is free for you to respond. Press the **PTT** button to transmit non-emergency voice to the same group the Emergency Alarm targeted.

The green LED lights up.

- 3 Do one of the following:
 - Wait for the Talk Permit Tone to end and speak clearly into the microphone if enabled.

- Wait for the **PTT** Sidetone to end and speak clearly into the microphone if enabled.

- 4 Release the **PTT** button to listen.

When the emergency initiating radio responds:

- The red LED blinks.
- The display shows the **Emergency Call** icon, the Emergency Talkgroup ID or alias, and the ID or alias of the transmitting radio.



NOTICE:

If the Emergency Call Indication is not enabled, the display shows the **Group Call** icon, Emergency Talkgroup ID or alias, and the ID or alias of the transmitting radio.

Responding to Emergency Alarms with Call

Follow the procedure to respond to Emergency Alarms with Call on your radio.

When you receive an Emergency Call:

- The Emergency Call Tone sounds if the Emergency Call Indication and Emergency Call Decode Tone is enabled. The Emergency Call Tone will not sound if only the Emergency Call Indication is enabled.
 - The display shows the **Emergency Call** icon at the top right corner.
 - The text line shows the Emergency Talkgroup ID or alias, and the ID or alias of the transmitting radio.
 - Your radio unmutes and the incoming call sounds through the speaker.
- 1 If the Channel Free Indication feature is enabled, you hear a short alert tone the moment the transmitting radio releases the **PTT** button, indicating the channel is free for you to respond. Press the **PTT** button to respond to the call.

The green LED lights up.

- 2 Wait for the Talk Permit Tone to end and speak clearly into the microphone if enabled.

- 3 Release the **PTT** button to listen.

When the emergency initiating radio responds:

- The red LED blinks.

- The display shows the **Emergency Call** icon, the Emergency Talkgroup ID or alias, and the ID or alias of the transmitting radio.



NOTICE:

If the Emergency Call Indication is not enabled, the display shows the **Group Call** icon, Emergency Talkgroup ID or alias, and the ID or alias of the transmitting radio.

Status Message

This feature allows the user to send status messages to other radios.

The Quick Status list is configured by using CPS-RM and comprises up to a maximum of 99 statuses.

The maximum length for each status message is 16 characters.



NOTICE:



Every status has a corresponding digital value ranging from 0–99. An alias can be specified to each status for ease of reference.



Sending Status Messages



Follow the procedure below to send a status message.



1 Do one of the following:

- Press the programmed **One Touch Access** button. Skip the following steps.
- Press  to access the menu.

2 Press  or  to **Status**. Press  to select.

3 Press  or  to **Quick Status**. Press  to select.

4 Press  or  to the required status message.
Press  to select.

5 Press  or  to the required subscriber alias or ID, or group alias or ID. Press  to select.

If successful:

- A positive indicator tone sounds.
- The LED turns off.
- The display shows a positive mini notice momentarily before returning to the **Quick Status** screen.
- The display shows  beside the sent status message.



If unsuccessful:



- A negative indicator tone sounds.
- The LED turns off.
- The display shows the failure notice momentarily before returning to the **Quick Status** screen.

Sending Status Message by Using Programmable Button

Follow the procedure to send a status message by using the programmable button.

1 Press the programmed **Status Message** button.

2 Press  or  to the required status message.
Press  to select. The contact list is displayed.

- 3 Press  or  to the required subscriber alias or ID, or group alias or ID. Press  to select.

If successful:

- A positive indicator tone sounds.
- The LED turns off.
- The display shows a positive mini notice momentarily before returning to the `Quick Status` screen.
- The display shows  beside the sent status message.



If unsuccessful:



- A negative indicator tone sounds.
- The LED turns off.
- The display shows the failure notice momentarily before returning to the `Quick Status` screen.



Sending a Status Message by Using the Contacts List



Follow the procedure to send a status message by using the contacts list.

- 1 Press  to access the menu.

- 2 Press  or  to `Contacts`. Press  to select.

- 3 Press  or  to the required subscriber alias or ID, or group alias or ID. Press  to select.

- 4 Press  or  to `Send Status`. Press  to select.

- 5 Press  or  to the required status message. Press  to select.

If successful:

- A positive indicator tone sounds.
- The LED turns off.
- The display shows a positive mini notice momentarily before returning to the `Quick Status` screen.
- The display shows  beside the sent status message.



If unsuccessful:



- A negative indicator tone sounds.
- The LED turns off.
- The display shows the failure notice momentarily before returning to the Quick Status screen.



Sending Status Message by Using Manual Dial

Follow the procedure to send a status message by using the manual dial.



1 Press  to access the menu.



2 Press  or  to Contacts. Press  to select.

3 Press  or  to Manual Dial. Press  to select.

4 Press  or  to Radio Number. Press  to select.

5 Enter the required subscriber alias or ID, or group alias or ID, and press  to proceed.

6 Press  or  to Send Status. Press  to select.

7 Press  or  to the required status message. Press  to select.

If successful:

- A positive indicator tone sounds.
- The LED turns off.
- The display shows a positive mini notice momentarily before returning to the Quick Status screen.
- The display shows  beside the sent status message.



If unsuccessful:



- A negative indicator tone sounds.
- The LED turns off.
- The display shows the failure notice momentarily before returning to the Quick Status screen.



Viewing Status Messages

Follow the procedure to view status messages.

- 1 Press  to access the menu.

- 2 Press  or  to Status. Press  to select.

- 3 Press  or  to Inbox. Press  to select.



- 4 Press  or  to the required status message.
Press  to select.
The content of the status message is displayed to the radio user.



Received status messages can also be viewed by accessing the Notification List. See [Notification List on page 181](#) for more information.



Responding to Status Messages

Follow the procedure to reply status messages.



- 1 Press  to access the menu.



- 2 Press  or  to Status. Press  to select.

- 3 Press  or  to Inbox. Press  to select.

- 4 Press  or  to the required status message.
Press  to select.

- 5 The content of the status is displayed. Press  to select.

- 6 Press  or  to Reply. Press  to select.

- 7 Press  or  to the required status message.
Press  to select.
-

If successful:

- A positive indicator tone sounds.
- The LED turns off.
- The display shows a positive mini notice before returning to the `Inbox` screen.
- The display shows  beside the sent status message.



If unsuccessful:

- A negative indicator tone sounds.
- The LED turns off.
- The display shows the failure notice momentarily before returning to the `Inbox` screen.



Deleting a Status Message

Follow the procedure to delete a status message from your radio.

- 1 Press  to access the menu.
-



- 2 Press  or  to `Status`. Press  to select.
-

- 3 Press  or  to `Inbox`. Press  to select.
-

- 4 Press  or  to the required status message.
Press  to select.
-

- 5 The content of the status is displayed. Press  to select.
-

- 6 Press  or  to `Delete`. Press  to select.
-



- 7 Press  or  to `Yes`. Press  to select.
-



- The display shows a positive mini notice before returning to the `Inbox` screen.



Deleting All Status Messages



Follow the procedure to delete all status messages from your radio.

- 1 Press  to access the menu.

- 2 Press  or  to Status. Press  to select.

- 3 Press  or  to Inbox. Press  to select.

- 4 Press  or  to Delete All. Press  to select.

- 5 Press  or  to Yes. Press  to select.

- The display shows List Empty.

Text Messaging

Your radio is able to receive data, for example a text message, from another radio or a text message application.

There are two types of text messages, Digital Mobile Radio (DMR) Short Text Message and text message. The maximum length of a DMR Short Text Message is 23 characters. The maximum length of a text message is 280 characters, including the subject line. The subject line only appears when you receive messages from e-mail applications.



NOTICE:

The maximum character length is only applicable for models with the latest software and hardware. For radio models with older software and hardware, the maximum length of a text message is 140 characters. Check with your dealer or system administrator for more information.

Text Messages



The text messages are stored in an Inbox, and sorted according to the most recently received.



The radio exits the current screen once the inactivity timer expires. Long press  at any time to return to the Home screen.



Viewing Text Messages

Follow the procedure to view text messages on your radio.

- 1 Press  to access the menu.

- 2 Press  or  to Messages. Press  to select.



- 3 Press  or  to Inbox. Press  to select.
If the Inbox is empty:
 - The display shows List Empty.
 - A tone sounds, if the Keypad Tone is turned on.



- 4 Press  or  to the required message. Press  to select.
The display shows a subject line if the message is from an e-mail application.



Viewing Telemetry Status Text Messages

Follow the procedure to view a telemetry status text message from the inbox.

- 1 Press  to access the menu.

- 2 Press  or  to Messages. Press  to select.

- 3 Press  or  to Inbox. Press  to select.

- 4 Press  or  to the required message. Press  to select.
You cannot reply to a Telemetry Status text message.
The display shows Telemetry: <Status Text Message>.

- 5 Long press  to return to the Home screen.

Responding to Text Messages

Follow the procedure to respond to text messages on your radio.

When you receive a text message:







- The display shows the Notification list with the alias or ID of the sender.
- The display shows the **Message** icon.





NOTICE:



The radio exits the Text Message alert screen and sets up a Private or Group Call to the sender of the message if the **PTT** button is pressed.

1 Do one of the following:

- Press  or  to Read. Press  to select.
The display shows the text message. The display shows a subject line if the message is from an e-mail application.
- Press  or  to Read Later. Press  to select.
The radio returns to the screen you were on prior to receiving the text message.

- Press  or  to Delete. Press  to select.

2 Do one of the following:



- Press  to return to inbox.
- Press  a second time to reply, forward, or delete the text message.

Responding to Text Messages with Quick Text



Follow the procedure to respond to text messages with Quick Text messages on your radio.

1 Do one of the following:

- Press the programmed **Text Message** button. Proceed to Step 3.
- Press  to access the menu.



2 Press  or  to Messages. Press  to select.



3 Press  or  to Inbox. Press  to select.



4 Press  or  to the required message. Press  to select.

The display shows a subject line if the message is from an e-mail application.

5 Press  to access the sub-menu.

6 Press  or  to Reply. Press  to select.

7 Press  or  to Quick Reply. Press  to select.

8 Press  or  to the required message. Press  to select.

The display shows a transitional mini notice, confirming the message is being sent.

9 Wait for acknowledgment.

If successful:

- A tone sounds.
- The display shows a positive mini notice.

If unsuccessful:

- A tone sounds.
 - The display shows a negative mini notice.
 - The radio returns to the Resend option screen.
-

Resending Text Messages

Follow the procedure to resend text messages on your radio.

When you are at the Resend option screen:

Press  to resend the same message to the same subscriber or group alias or ID.

If successful:

- A positive indicator tone sounds.
- The display shows a positive mini notice.



If unsuccessful:



- A negative indicator tone sounds.
- The display shows a negative mini notice.
- The radio returns to the **Resend** option screen.

Forwarding Text Messages

Follow the procedure to forward text messages on your radio.

When you are at the **Resend** option screen:

1 Press  or  to **Forward**, and press  to send the same message to another subscriber or group alias or ID.

2 Press  or  to the required alias or ID.
Press  to select.

The display shows a transitional mini notice, confirming your message is being sent.

3 Wait for acknowledgment.

If successful:

- A tone sounds.
- The display shows a positive mini notice.

If unsuccessful:

- A tone sounds.
- The display shows a negative mini notice.



NOTICE:



You can also manually select a target radio address (see [Forwarding Text Messages by Using the Manual Dial](#) on page 420).

Forwarding Text Messages by Using the Manual Dial

Follow the procedure to forward text messages by using the manual dial on your radio.

1 Press  or  to **Forward**. Press  to select.

2 Press  to send the same message to another subscriber or group alias or ID.

3 Press  or  to Manual Dial. Press  to select.

The display shows Radio Number:.

4 Enter the subscriber ID, and press  to proceed.

The display shows a transitional mini notice, confirming your message is being sent.

5 Wait for acknowledgment.

If successful:

- A tone sounds.
- The display shows a positive mini notice.

If unsuccessful:

- A tone sounds.
 - The display shows a negative mini notice.
-

Editing Text Messages

Select **Edit** to edit the message.







NOTICE:

If a subject line is present (for messages received from an e-mail application), you cannot edit it.

1 Press  or  to **Edit**. Press  to select.









The display shows a blinking cursor.

2 Use the keypad to edit your message.

- Press  to move one space to the left.
 - Press  or  to move one space to the right.
 - Press  to delete any unwanted characters.
 - Long press  to change text entry method.
-

3 Press  once message is composed.



4 Do one of the following:



- Press  or  to **Send** and press  to send the message.
- Press  or  to **Save** and press  to save the message to the Drafts folder.
- Press  to edit the message.
- Press  to choose between deleting the message or saving it to the Drafts folder.

Writing Text Messages

Follow the procedure to write text message on your radio.

- 1 Do one of the following:
 - Press the programmed **Text Message** button. Proceed to [step 3](#).
 - Press  to access the menu.

- 2 Press  or  to **Messages**. Press  to select.

- 3 Press  or  to **Compose**. Press  to select.

A blinking cursor appears.

- 4 Use the keypad to type your message.

Press  to move one space to the left.





Press  or  to move one space to the right.

Press  to delete any unwanted characters.

Long press  to change text entry method.

- 5 Press  once message is composed.

Do one of the following:







- Press  to send the message.
- Press . Press  or  to choose among editing, deleting, or saving the message. Press  to select.

Sending Text Messages

Follow the procedure to send text message on your radio.

It is assumed that you have a newly written text message or a saved text message.

Select the message recipient. Do one of the following:

- Press  or  to the required alias or ID. Press  to select.
- Press  or  to Manual Dial. Press  to select. Key in the subscriber ID. The first line of the display shows `Radio Number:`. The second line of the display shows a blinking cursor. Key in the subscriber alias or ID. Press .

The display shows transitional mini notice, confirming your message is being sent.

If successful:

- A tone sounds.
- The display shows positive mini notice.

If unsuccessful:

- A low tone sounds.
- The display shows negative mini notice.
- The message is moved to the Sent Items folder.
- The message is marked with a Send Failed icon.









NOTICE:

For a newly written text message, the radio returns you to the `Resend` option screen.

Deleting Text Messages from the Inbox



Follow the procedure to delete text messages from the Inbox on your radio.

- 1 Do one of the following:
 - Press the programmed **Text Message** button. Proceed to [step 3](#).
 - Press  to access the menu.
 - 2 Press  or  to `Messages`. Press  to select.
-

3 Press  or  to **Inbox**. Press  to select.

If the Inbox is empty:

- The display shows **List Empty**.
 - A tone sounds.
-



4 Press  or  to the required message. Press

 to select.

The display shows a subject line if the message is from an e-mail application.

5 Press  to access the sub-menu.

6 Press  or  to **Delete**. Press  to select.

7 Press  or  to **Yes**. Press  to select.



The display shows a positive mini notice. The screen returns to the Inbox.



Deleting All Text Messages from the Inbox

Follow the procedure to delete all text messages from the Inbox on your radio.

1 Do one of the following:



- Press the programmed **Text Message** button. Proceed to [step 3](#).
 - Press  to access the menu.
-



2 Press  or  to **Messages**. Press  to select.

3 Press  or  to **Inbox**. Press  to select.

If the Inbox is empty:

- The display shows **List Empty**.
 - A tone sounds.
-

4 Press  or  to **Delete All**. Press  to select.

- 5 Press  or  to Yes. Press  to select.

The display shows a positive mini notice.

Sent Text Messages

Once a message is sent to another radio, it is saved in Sent Items folder. The most recent sent text message is always added to the top of the Sent Items folder. You can resend, forward, edit, or delete a Sent text message.

The Sent Items folder is capable of storing a maximum of 30 last sent messages. When the folder is full, the next sent text message automatically replaces the oldest text message in the folder.

If you exit the message sending screen while the message is being sent, the radio updates the status of the message in the Sent Items folder without providing any indication in the display or via sound.

If the radio changes mode or powers down before the status of the message in Sent Items folder is updated, the radio cannot complete any In-Progress messages and automatically marks it with a **Send Failed** icon.

The radio supports a maximum of five In-Progress messages at one time. During this period, the radio cannot

send any new message and automatically marks it with a **Send Failed** icon.

If you long press  at any time, the radio returns to the Home screen.





NOTICE:



If the channel type, for example a conventional digital or Capacity Plus channel, is not a match, you can only edit, forward, or delete a Sent message.

Viewing Sent Text Messages

Follow the procedure to view sent text messages on your radio.



- Do one of the following:
 - Press the programmed **Text Message** button. Proceed to [step 3](#).
 - Press  to access the menu.
-

- Press  or  to Messages. Press  to select.
-

- 3 Press  or  to Sent Items. Press  to select.

If the Sent Items folder is empty:

- The display shows List Empty.
- A low tone sounds, if the Keypad Tone is turned on.

- 4 Press  or  to the required message. Press  to select.

The icon at the top right corner of the screen indicates the status of the message. See [Sent Item Icons](#).





Sending Sent Text Messages

Follow the procedure to send a sent text messages on your radio.

When you are viewing a Sent message:

- 1 Press .

- 2 You can either resend or forward the sent text message. Do one of the following:

-  to Resend. Press  to select.
-  to Forward. Press  to select.

The display shows a transitional mini notice, confirming your message is being sent.

- 3 Wait for acknowledgment.

If successful:

- A tone sounds.
- The display shows a positive mini notice.

If unsuccessful:

- A tone sounds.
- The display shows a negative mini notice.
- The radio proceeds to the Resend option screen. See [Resending Text Messages on page 146](#) for more information.

Deleting Sent Text Messages from the Sent Items Folder

Follow the procedure to delete sent text messages from the Sent Items folder on your radio.

When you are viewing a Sent message:

1 Press .



2 Press  or  to Delete. Press  to select.



Deleting All Sent Text Messages from the Sent Items Folder

Follow the procedure to delete all sent text messages from the Sent Items folder on your radio.

1 Do one of the following:



- Press the programmed **Text Message** button. Proceed to [step 3](#).
 - Press  to access the menu.
-

2 Press  or  to Messages. Press  to select.







3 Press  or  to Sent Items. Press  to select.

If the Sent Items folder is empty:

- The display shows List Empty.
 - A tone sounds.
-

4 Press  or  to Delete All. Press  to select.

5 Do one of the following:

- Press  or  to Yes. Press  to select.
The display shows a positive mini notice.
 - Press  or  to No. Press  to select.
The radio returns to the previous screen.
-

Saved Text Messages

You can save a text message to send it at a later time.

If a **PTT** button press or a mode change causes the radio to exit the text message writing/editing screen while you are in the process of writing or editing a text message, your current text message is automatically saved to the Drafts folder.



The most recent saved text message is always added to the top of the Drafts list.

The Drafts folder stores a maximum of 10 last saved messages. When the folder is full, the next saved text message automatically replaces the oldest text message in the folder.



Viewing Saved Text Messages

Follow the procedure to view saved text message on your radio.

- 1 Do one of the following:
 - Press the programmed **Text Message** button. Proceed to [step 3](#).
 - Press  to access the menu.
-





- 2 Press  or  to Messages. Press  to select.
-

- 3 Press  or  to Drafts. Press  to select.
-

- 4 Press  or  to the required message. Press  to select.
-

Editing Saved Text Messages

Follow the procedure to edit saved text message on your radio.

- 1 Press  while viewing the message.
-
- 2 Press  or  to Edit. Press  to select. A blinking cursor appears.
-
- 3 Use the keypad to type your message.

Press  to move one space to the left.







Press  or  to move one space to the right.

Press  to delete any unwanted characters.

Long press  to change text entry method.

4 Press  once message is composed.

Do one of the following:

- Press  or  to Send. Press  to send the message.
- Press . Press  or  to choose between saving or deleting the message. Press  to select.

Deleting Saved Text Messages from the Drafts Folder



Follow the procedure to delete saved text message from drafts on your radio.



1 Do one of the following:

- Press the programmed **Text Message** button. Proceed to [step 3](#).
- Press  to access the menu.

2 Press  or  to Messages. Press  to select.

3 Press  or  to Drafts. Press  to select.

4 Press  or  to the required message. Press  to select.

5 Press  or  to Delete. Press  to delete the text message.





Quick Text Messages



Your radio supports a maximum of 50 Quick Text messages as programmed by your dealer.



While Quick Text messages are predefined, you can edit each message before sending it.

Sending Quick Text Messages

Follow the procedure to send predefined Quick Text messages on your radio to a predefined alias.

- 1 Do one of the following:
 - Press the programmed **Text Message** button. Proceed to [step 3](#).
 - Press the programmed **One Touch Access** button. Proceed to [step 6](#).
The display shows a transitional mini notice, confirming your message is being sent.
 - Press  to access the menu.
-
- 2 Press  or  to Messages. Press  to select.
-

- 3 Press  or  to Quick Text. Press  to select.
-

- 4 Press  or  to the required Quick Text message. Press  to select.
-

- 5 Do the following to select the recipient and send the message.

The display shows a transitional mini notice, confirming that your message is being sent.

- 6 Wait for acknowledgment.

If successful:

- A positive indicator tone sounds.
- The display shows a positive mini notice.

If unsuccessful:

- A negative indicator tone sounds.
- The display shows a negative mini notice.

- The radio proceeds to the Resend option screen. See [Resending Text Messages on page 146](#) for more information.

Text Entry Configuration

Your radio allows you to configure different text.

You can configure the following settings for entering text on your radio:



- Word Predict
- Word Correct
- Sentence Cap
- My Words

Your radio supports the following text entry methods:

- Numbers
- Symbols
- Predictive or Multi-Tap
- Language (If programmed)















NOTICE:

Press  at any time to return to the previous screen or long press  to return to the Home Screen. The radio exits the current screen once the inactivity timer expires.



Enabling or Disabling Word Correct

Supplies alternative word choices when the word entered into the text editor is not recognized by the in-built dictionary.

- 1 Press  to access the menu.
- 2 Press  or  to Utilities. Press  to select.
- 3 Press  or  to Radio Settings. Press  to select.
- 4 Press  or  to Text Entry. Press  to select.

5 Press  or  to Word Correct. Press  to select.



6 Do one of the following:

- Press  or  to Word Correct. Press  to select.
 - Press to enable Word Correct. If enabled, ✓ appears beside Enabled.
 - Press to disable Word Correct. If disabled, ✓ disappears beside Enabled.
-



Enabling or Disabling Word Predict



Word Predict: Your radio can learn common word sequences that you often enter. It then predicts the next word you may want to use after you enter the first word of a common word sequence into the text editor.

1 Press  to access the menu.



2 Press  or  to Utilities. Press  to select.

3 Press  or  to Radio Settings. Press  to select.

4 Press  or  to Text Entry. Press  to select.

5 Press  or  to Word Predict. Press  to select.



6 Do one of the following:



- Press  to enable the Word Predict. If enabled, ✓ appears beside Enabled.
 - Press  to disable Microphone Dynamic Distortion Control. If disabled, ✓ disappears beside Enabled.
-



Sentence Cap



This feature is used to automatically enable capitalization of the first letter in the first word for every new sentence.

- 1 Press  **OK** to access the menu.



- 2 Press  or  to Utilities. Press  **OK** to select.

- 3 Press  or  to Radio Settings. Press  **OK** to select.

- 4 Press  or  to Text Entry. Press  **OK** to select.

- 5 Press  or  to Sentence Cap. Press  **OK** to select.



- 6 Do one of the following:



- Press  **OK** to enable Sentence Cap. If enabled, ✓ appears beside Enabled.
- Press  **OK** to disable Sentence Cap. If disabled, ✓ disappears beside Enabled.



Viewing Custom Words



You can add your own custom words into the in-built dictionary of your radio. Your radio maintains a list to contain these words.



- 1 Press  **OK** to access the menu.

- 2 Press  or  to Utilities. Press  **OK** to select.

- 3 Press  or  to Radio Settings. Press  **OK** to select.

4 Press  or  to Text Entry. Press  to select.



5 Press  or  to My Words. Press  to select.



6 Press  or  to List of Words. Press  to select.
The display shows the list of custom words.



Editing Custom Words



You can edit custom words saved in your radio.



1 Press  to access the menu.

2 Press  or  to Utilities. Press  to select.

3 Press  or  to Radio Settings. Press  to select.

4 Press  or  to Text Entry. Press  to select.





5 Press  or  to My Words. Press  to select.

6 Press  or  to List of Words. Press  to select.
Display shows the list of custom words.

7 Press  or  to the required word. Press  to select.

8 Press  or  to Edit. Press  to select.

9 Use the keypad to edit your custom word.

- Press  to move one space to the left.
- Press  key to move one space to the right.
- Press the  key to delete any unwanted characters.
- Long press  to change text entry method.

10 Press  once your custom word is completed.



The display shows transitional mini notice, confirming your custom word is being saved.

- If the custom word is saved, a tone sounds and the display shows positive mini notice.
- If the custom word is not saved, a low tone sounds and the display show negative mini notice.



Adding Custom Words



You can add custom words into the in-built radio dictionary.



1 Press  to access the menu.

2 Press  or  to Utilities. Press  to select.



3 Press  or  to Radio Settings. Press  to select.



4 Press  or  to Text Entry. Press  to select.

5 Press  or  to My Words. Press  to select.

6 Press  or  to Add New Word. Press  to select.
Display shows the list of custom words.

7 Use the keypad to edit your custom word.

- Press  to move one space to the left.
- Press  key to move one space to the right.

- Press the  key to delete any unwanted characters.
- Long press  to change text entry method.

8 Press  once your custom word is completed.



The display shows transitional mini notice, confirming your custom word is being saved.



- If the custom word is saved, a tone sounds and the display show positive mini notice.
- If the custom word is not saved, a low tone sounds and the display show negative mini notice.



Deleting a Custom Word



Follow the procedure to delete the custom words saved in your radio.



1 Press  to access the menu.

2 Press  or  to Utilities. Press  to select.

3 Press  or  to Radio Settings. Press  to select.





4 Press  or  to Text Entry. Press  to select.

5 Press  or  to My Words. Press  to select.

6 Press  or  to the required word. Press  to select.

7 Press  or  to Delete. Press  to select.



8 Choose one of the following.



- At Delete Entry?, press  to select Yes. The display shows Entry Deleted.
- Press  or  to No. Press  to return to the previous screen.



Deleting All Custom Words



Follow the procedure to delete all custom words from the in-built dictionary of your radio.



- 1 Press  to access the menu.

- 2 Press  or  to Utilities. Press  to select.





- 3 Press  or  to Radio Settings. Press  to select.

- 4 Press  or  to Text Entry. Press  to select.

- 5 Press  or  to My Words. Press  to select.

- 6 Press  or  to Delete All. Press  to select.

7 Do one of the following:

- At Delete Entry?, press  to select Yes. The display shows All Entries Deleted.
 - Press  or  to No to return to the previous screen. Press  to select.
-

Job Tickets

This feature allows your radio to receive messages from the dispatcher listing out tasks to perform.



NOTICE:

This feature can be customized through CPS according to user requirements. Check with your dealer or system administrator for more information.

There are two folders that contain different Job Tickets:

My Tasks folder

Personalized Job Tickets assigned to your signed in user ID.

Shared Tasks folder

Shared Job Tickets assigned to a group of individuals.

You can respond to Job Tickets in order to sort them into Job Ticket Folders. By default, the folders are **All**, **New**, **Started**, and **Completed**. Check with your dealer or system administrator for an additional 10 folders.



NOTICE:

Job Tickets are retained even after the radio is powered down and powered up again.

All Job Tickets are located in the **All** folder. Depending on how your radio is programmed, Job Tickets are sort by their priority level followed by time received. New Job Tickets, Job Tickets with recent changes in state, and Job Tickets with the highest priority are listed first. Upon reaching the maximum number of Job Tickets, the next Job Ticket automatically replaces the last Job Ticket in your radio. Your radio supports a maximum of 100 or 500 Job Tickets, depending on your radio model. Check with your dealer or system administrator for more information. Your radio automatically detects and discards duplicated Job Tickets with the same Job Ticket ID.

Depending on the importance of the Job Tickets, the dispatcher adds a Priority Level to them. There are three priority levels: Priority 1, Priority 2, and Priority 3. Priority 1 has the highest priority and Priority 3 has the lowest priority. There are also Job Tickets with no priority.

Your radio updates accordingly when dispatcher makes the following changes:



- Modify content of Job Tickets.
- Add or edit Priority Level of Job Tickets.
- Move Job Tickets from folder to folder.
- Canceling of Job Tickets.



Accessing the Job Ticket Folder



Follow the procedure to access the Job Ticket folder.

1 Do one of the following:

- Press the programmed **Job Ticket** button. Proceed to [step 3](#).
- Press  to access the menu.





2 Press  or  to Job Tickets. Press  to select.

3 Press  or  to the required folder. Press  to select.

- 4 Press  or  to the required Job Ticket.
Press  to select.
-

Logging In or Out of the Remote Server

This feature allows you to log in and log out of the remote server by using your user ID.

- 1 Press  to access the menu.
-
- 2 Press  or  to Log In. Press  to select.
- If you are already logged in, menu displays Log Out.
- The display shows a transitional mini notice, indicating the request is in progress.
-
- 3 Wait for acknowledgment.
- If successful:
- A positive indicator tone sounds.
 - The display shows a positive mini notice.







If unsuccessful:

- A negative indicator tone sounds.
 - The display shows a negative mini notice.
-

Creating Job Tickets

Your radio is able to create Job Tickets, which are based on a Job Ticket template and send out tasks that need to be performed.



CPS programming software is required to configure the Job Ticket template.



- 1 Press  to access the menu.
-
- 2 Press  or  to Job Tickets. Press  to select.
-
- 3 Press  or  to Create Ticket. Press  to select.
-



Responding to Job Tickets

Follow the procedure to respond to job tickets on your radio.



- 1 Press  to access the menu.

- 2 Press  or  to Job Tickets. Press  to select.

- 3 Press  or  to the required folder. Press  to select.

- 4 Press  or  to the required job ticket. Press  to select.

- 5 Press  once more to access the sub-menu.
You can also press the corresponding number key (1–9) to **Quick Reply**.

- 6 Press  or  to the required job ticket. Press  to select.

The display shows a transitional mini notice, indicating the request is in progress.

- 7 Wait for acknowledgment.

If successful:

- A positive indicator tone sounds.
- The display shows a positive mini notice.

If unsuccessful:

- A negative indicator tone sounds.
 - The display shows a negative mini notice.
-



Sending Job Tickets Using One Job Ticket Template

If your radio is configured with one Job Ticket template, perform the following actions to send the Job Ticket.

- 1 Use the keypad to type the required room number.

Press  to select.

- 2 Press  or  to Room Status. Press  to select.
-

- 3 Press  or  to the required option. Press  to select.
-

- 4 Press  or  to Send. Press  to select.

The display shows a transitional mini notice, indicating the request is in progress.

- 5 Wait for acknowledgment.

If successful:



- A positive indicator tone sounds.
- The display shows a positive mini notice.

If unsuccessful:

- A negative indicator tone sounds.
 - The display shows a negative mini notice.
-

Sending Job Tickets Using More Than One Job Ticket Template

If your radio is configured with more than one Job Ticket template, perform the following actions to send the Job Tickets.

- 1 Press  or  to the required option. Press  to select.
-

- 2 Press  or  to Send. Press  to select.

The display shows a transitional mini notice, indicating the request is in progress.

3 Wait for acknowledgment.

If successful:

- A positive indicator tone sounds.
- The display shows a positive mini notice.

If unsuccessful:

- A negative indicator tone sounds.
 - The display shows a negative mini notice.
-

Deleting Job Tickets

Follow the procedure to delete job tickets on your radio.

1 Do one of the following:

- Press the programmed **Job Ticket** button.
Proceed to [step 4](#)
 - Press  to access the menu.
-

2 Press or to Job Tickets. Press to select.

3 Press or to the required folder. Press to select.

4 Press or to All folder. Press to select.

5 Press or to the required Job Ticket. Press to select.

6 Press again while viewing the Job Ticket.

7 Press or to Delete. Press to select.

The display shows a transitional mini notice, indicating the request is in progress.

8 Wait for acknowledgment.

If successful:

- A positive indicator tone sounds.
- The display shows a positive mini notice.

If unsuccessful:

- A negative indicator tone sounds.
 - The display shows a negative mini notice.
-



Deleting All Job Tickets



Follow the procedure to delete all job tickets on your radio.



1 Do one of the following:

- Press the programmed **Job Ticket** button. Proceed to [step 3](#).
 - Press  to access the menu.
-







2 Press  or  to Job Tickets. Press  to select.

3 Press  or  to the required folder. Press  to select.

4 Press  or  to All folder. Press  to select.

5 Press  or  to Delete All. Press  to select.

6 Do one of the following:

- Press  or  to Yes. Press  to select.
The display shows a positive mini notice.
 - Press  or  to No. Press  to select.
The radio returns to the previous screen.
-

Privacy

This feature helps to prevent eavesdropping by unauthorized users on a channel by the use of a software-based scrambling solution. The signaling and user identification portions of a transmission are not scrambled.

Your radio must have privacy enabled on the channel to send a privacy-enabled transmission, although this is not a necessary requirement for receiving a transmission. While

on a privacy-enabled channel, the radio is still able to receive clear or unscrambled transmissions.

Your radio only supports Enhanced Privacy. To unscramble a privacy-enabled call or data transmission, your radio must be programmed to have the same Key Value and Key ID for Enhanced Privacy as the transmitting radio.

If your radio receives a scrambled call that is of a different Key Value and Key ID, you hear nothing at all for Enhanced Privacy.

On a privacy-enabled channel, your radio is able to receive clear or unscrambled calls, depending on how your radio is programmed. In addition, your radio may play a warning tone or not, depending on how it is programmed.



NOTICE:

This feature is not applicable in Citizens Band channels that are in the same frequency.

The green LED lights up when the radio is transmitting, and blinks rapidly when the radio is receiving an ongoing privacy-enabled transmission.







NOTICE:



Some radio models may not offer this Privacy feature, or may have a different configuration. Check with your dealer or system administrator for more information.



Turning Privacy On or Off





Follow the procedure to turn privacy on or off on your radio.





- 1 Do one of the following:
 - Press the programmed **Privacy** button. Skip the steps below.
 - Press  to access the menu.

- 2 Press  or  to Utilities. Press  to select.

- 3 Press  or  to Radio Settings. Press  to select.

- 4 Press  or  to Privacy. Press  to select.

- 5 Do one of the following:
 - Press  or  to On. Press  to select. The display shows  beside On.

- Press  or  to Off. Press  to select. The display shows  beside Off.

Response Inhibit

This feature helps prevent your radio from responding to any incoming transmissions.



NOTICE:

This is a purchasable feature. Check with your dealer or system administrator to determine how your radio has been programmed.

If enabled, your radio does not generate any outgoing transmissions in respond to incoming transmissions, such as Radio Check, Call Alert, Radio Disable, Remote Monitor, Automatic Registration Service (ARS), Responding to Private Messages, and Sending GNSS location reports. Your radio cannot receive Confirmed Private Calls when this feature is enabled. However, your radio is able to manually send transmission.

Turning Response Inhibit On or Off

Follow the procedure to enable or disable Response Inhibit on your radio.

Press the programmed **Response Inhibit** button.

If successful:

- A positive indicator tone sounds.
- The display shows a momentary positive mini notice.

If unsuccessful:

- A negative indicator tone sounds.
- The display shows a momentary negative mini notice.

Stun/Revive

This feature allows you to enable or disable any radio in the system. For example, the dealer or system administrator may want to disable a stolen radio to prevent unauthorized users from using it, and enable the radio when it is recovered.

A radio can be disabled (stunned) or enabled (revived) either through the console or through a command initiated by another radio.

Once a radio is disabled, the radio sounds a negative indicator tone and the home screen shows Channel Denied.

When a radio is stunned, the radio cannot request nor receive any user initiated services on the system that performed the Stun procedure. However, the radio can switch to another system. The radio continues to send GNSS location reports and can be monitored remotely when it was stunned.





NOTICE:

The dealer or system administrator may permanently disable a radio. See [Radio Kill on page 177](#) for more information.

Stunning a Radio

Follow the procedure to disable a radio.

- 1 Press the programmed **Radio Disable** button.

- 2 Press  or  to the required alias or ID.
Press  to select.

The display shows a transitional mini notice, indicating the request is in progress. The green LED blinks.

- 3 Wait for acknowledgment.

If successful:

- A positive indicator tone sounds.
- The display shows a positive mini notice.



If unsuccessful:



- A negative indicator tone sounds.
 - The display shows a negative mini notice.
-

Stunning a Radio by Using the Contacts List



Follow the procedure to disable a radio by using the Contacts List.

- 1 Press  to access the menu.

- 2 Press  or  to **Contacts**. Press  to select.

3 Press  or  to the required alias or ID.

Press  to select.

4 Press  or  to Radio Disable. Press  to select.

The display shows a transitional mini notice, indicating the request is in progress. The green LED blinks.

5 Wait for acknowledgment.

If successful:

- A positive indicator tone sounds.
- The display shows a positive mini notice.



If unsuccessful:



- A negative indicator tone sounds.
 - The display shows a negative mini notice.
-



Stunning a Radio by Using the Manual Dial

Follow the procedure to disable a radio by using the manual dial.

1 Press  to access the menu.



2 Press  or  to Contacts. Press  to select.

3 Press  or  to Manual Dial. Press  to select.

4 Press  or  to Radio Number. Press  to select.

The first text line shows Radio Number:.

5 Enter the subscriber ID, and press  to proceed.

- 6 Press  or  to Radio Disable. Press  to select.

The display shows a transitional mini notice, indicating the request is in progress. The green LED blinks.



- 7 Wait for acknowledgment.

If successful:

- A positive indicator tone sounds.
- The display shows a positive mini notice.

If unsuccessful:

- A negative indicator tone sounds.
 - The display shows a negative mini notice.
-

- 2 Press  or  to the required alias or ID. Press  to select.

The display shows Radio Enable and the subscriber alias or ID. The green LED lights up.

- 3 Wait for acknowledgment.

If successful:

- A positive indicator tone sounds.
- The display shows a positive mini notice.

If unsuccessful:

- A negative indicator tone sounds.
 - The display shows a negative mini notice.
-

Reviving a Radio



Follow the procedure to enable a radio.



- 1 Press the programmed **Radio Enable** button.
-



Reviving a Radio by Using the Contacts List

Follow the procedure to enable a radio by using the Contacts List.

- 1 Press  to access the menu.

- 2 Press  or  to `Contacts`. Press  to select.

- 3 Press  or  to the required alias or ID.
Press  to select.

- 4 Press  or  to `Radio Enable`. Press  to select.
The green LED blinks.
The display shows `Radio Enable` and the subscriber alias or ID. The green LED lights up.

- 5 Wait for acknowledgment.

If successful:

- A tone sounds.
- The display shows `Radio Enable Successful`.



If unsuccessful:



- A tone sounds.
- The display shows `Radio Enable Failed`.



Reviving a Radio by Using the Manual Dial

Follow the procedure to enable a radio by using the Manual Dial.

- 1 Press  to access the menu.



- 2 Press  or  to `Contacts`. Press  to select.

3 Press  or  to Manual Dial. Press  to select.

4 Press  or  to Private Call. Press  to select.

The first text line shows Radio Number:.

5 Enter the subscriber ID, and press  to proceed.

6 Press  or  to Radio Enable. Press  to select.

The green LED blinks.

The display shows Radio Enable and the subscriber alias or ID. The green LED lights up.

7 Wait for acknowledgment.

If successful:

- A tone sounds.
- The display shows Radio Enable Successful.

If unsuccessful:

- A tone sounds.
- The display shows Radio Enable Failed.

Radio Kill

This feature is an enhanced security measure to restrict unauthorized access to a radio.

Radio Kill causes a radio to be rendered inoperable. For example, the dealer or system administrator may want to kill a stolen or misplaced radio to prevent unauthorized usage.

When powered on, a killed radio displays Radio Killed on the screen momentarily to indicate the killed state.



NOTICE:

A killed radio can only be revived at a Motorola Solutions service depot. Check with your dealer or system administrator for more information.

Lone Worker

This feature prompts an emergency to be raised if there is no user activity, such as any radio button press or activation of the channel selector, for a predefined time.

Following no user activity for a programmed duration, the radio pre-warns you using an audio indicator once the inactivity timer expires.

If there is still no acknowledgment by you before the predefined reminder timer expires, the radio initiates an emergency condition as programmed by the dealer or system administrator.

See [Emergency Operation on page 130](#) for more information.



NOTICE:

Check with your dealer or system administrator for more information.

Password Lock Features

This feature allows you to restrict access to the radio by asking for a password when the device is turned on.

You can use a keypad microphone or **Scroll Up/Down** buttons to enter the password.

Accessing Radios by Using Passwords



Follow the procedure to access your radio by using a password.

- 1 Enter the current four-digit password.



NOTICE:

The use of **Emergency** footswitch cancels out password input to access the radio.

- Use a keypad microphone.
- Press  or  to edit the numeric value of each digit, and press  to enter and move to the next digit.

- 2 Press  to enter the password.

If successful, the radio powers up.

If unsuccessful:

- After the first and second attempt, the display shows `Wrong Password`. Repeat [step 1](#).
- After the third attempt, the display shows `Wrong Password` and then, `Radio Locked`. A tone

sounds. The yellow LED double blinks. Your radio enters into locked state for 15 minutes.



NOTICE:

In locked state, your radio responds to inputs from the **On/Off/Volume Control Knob** and programmed **Backlight** button only.

Unlocking Radios in Locked State

Your radio is unable to receive calls in locked state. Follow the procedure to unlock your radio in locked state.











Do one of the following:



- If the radio is powered on, wait for 15 minutes and then repeat the steps in [Accessing Radios by Using Passwords on page 178](#) to access the radio.
- If the radio is powered off, power up the radio. Your radio restarts the 15-minute timer for locked state. A tone sounds. The yellow LED double blinks. The display shows `Radio Locked`.

Wait for 15 minutes and then repeat the steps in [Accessing Radios by Using Passwords on page 178](#) to access the radio.

Turning Password Lock On or Off

Follow the procedure to turn password lock on or off on your radio.







- 1 Press  to access the menu.
- 2 Press  or  to Utilities. Press  to select.
- 3 Press  or  to Radio Settings. Press  to select.
- 4 Press  or  to Passwd Lock. Press  to select.
- 5 Enter the current four-digit password.
 - Use a keypad microphone.

- Press  or  to edit the numeric value of each digit, and press  to enter and move to the next digit.
A positive indicator tone sounds for every digit pressed.

-
- 6 Press  to enter the password.

If the password is incorrect, the display shows `Wrong Password` and automatically returns to the previous menu.



-
- 7 Do one of the following:



- Press  or  to Turn On. Press  to select.
The display shows `✓ Turn On`.
- Press  or  to Turn Off. Press  to select.
The display shows `✓ Turn Off`.



Changing Passwords

Follow the procedure to change passwords on your radio.

-
- 1 Press  to access the menu.



-
- 2 Press  or  to Utilities. Press  to select.

-
- 3 Press  or  to Radio Settings. Press  to select.

-
- 4 Press  or  to Passwd Lock. Press  to select.

-
- 5 Enter the current four-digit password, and press  to proceed.

If the password is incorrect, the display shows `Wrong Password` and automatically returns to the previous menu.

-
- 6 Press  or  to Change PWD. Press  to select.
-

7 Enter a new four-digit password, and press  to proceed.

8 Re-enter the new four-digit password, and press  to proceed.

If successful, the display shows `Password Changed`.
If unsuccessful, the display shows `Passwords Do Not Match`.

The screen automatically returns to the previous menu.

Notification List

Your radio has a Notification list that collects all your unread events on the channel, such as unread text messages, telemetry messages, missed calls, and call alerts.

The display shows the **Notification** icon when the Notification list has one or more events.

The list supports a maximum of 40 unread events. When the list is full, the next event automatically replaces the



oldest event. After the events are read, they are removed from the Notification list.



For text messages, missed calls, and call alert events, the maximum number of notifications are 30 text messages and 10 missed calls or call alerts. This maximum number depends on individual feature (job tickets or text messages or missed calls or call alerts) list capability.

Accessing Notification List

Follow the procedure to access the Notification list on your radio.

- 1 Press  to access the menu.

- 2 Press  or  to Notification. Press  to select.

- 3 Press  or  to the required event. Press  to select.

Long press  to return to the Home screen.

Over-the-Air Programming

Your dealer can remotely update your radio by using Over-the-Air Programming (OTAP) without physical connection. Additionally, some settings can also be configured by using OTAP.

When your radio undergoes OTAP, the green LED blinks.

When your radio receives high volume data:

- The display shows the **High Volume Data** icon.
- The channel becomes busy.
- A negative tone sounds if you press the **PTT** button.

When OTAP completes, depending on the configuration:

- A tone sounds. The display shows `Updating`
`Restarting`. Your radio restarts by powering off and on again.
- You can select `Restart Now` or `Postpone`. When you select `Postpone`, your radio returns to the previous screen. The display shows the **OTAP Delay Timer** icon until the automatic restart occurs.

When your radio powers up after automatic restart:

- If successful, the display shows `Sw Update`
`Completed`.

- If unsuccessful, the display shows `Sw Update Failed`.



See [Checking Software Update Information on page 213](#) for the updated software version.



Selecting Third-Party Peripherals Connection Modes



Follow the procedure to select one of the following third-party peripherals connection modes:



- Motorola Solutions
- PC and Audio
- Data Accessory
- Telemetry
- Generic

1 Press  to access the menu.

2 Press  or  to Utilities. Press  to select.

3 Press  or  to Radio Settings. Press  to select.

4 Press  or  to Cable Type. Press  to select.

5 Press  or  to the required connection mode. Press  to select.

The display shows the selected connection mode.
The screen returns to the previous menu.



Received Signal Strength Indicator

This feature allows you to view the Received Signal Strength Indicator (RSSI) values.

The display shows the **RSSI** icon at the top right corner.
See [Display Icons](#) for more information on the **RSSI** icon.

Viewing RSSI Values

Attach the 4-Way Navigation Keypad Microphone (Motorola Solutions part number RMN5127_) to your radio.

At the home screen, using the 4-Way Navigation Keypad Microphone, press  three times and immediately press  three times.

The display shows the current RSSI values.

To return to the home screen, press and hold .

Front Panel Configuration



You are able to customize certain feature parameters in Front Panel Configuration (FPC) to enhance the use of your radio.



Entering Front Panel Configuration Mode

Follow the procedure to enter front panel programming mode on your radio.

Long press  at any time to return to the Home screen.



- 1 Press  to access the menu.



- 2 Press  or  to Utilities. Press  to select.

- 3 Press  or  to Program Radio. Press  to select.

Editing FPP Mode Parameters

Use the following buttons as required while navigating through the feature parameters.

-  ,  – Scroll through options, increase/decrease values, or navigate vertically.

-  – Select the option or enter a sub-menu.
-  – Short-press to return to previous menu or to exit the selection screen. Long-press to return to Home screen.

Wi-Fi Operation

This feature allows you to set up and connect to a Wi-Fi network. Wi-Fi supports updates for radio firmware, codeplug, and resources such as language packs and voice announcement.



NOTICE:

This feature is applicable to XiR M8668i/CM7668i only.

Wi-Fi® is a registered trademark of Wi-Fi Alliance®.

Your radio supports WEP/WPA/WPA2-Personal and WPA/WPA2-Enterprise Wi-Fi networks.

WEP/WPA/WPA2-Personal Wi-Fi network

Uses pre-shared key (password) based authentication.

Pre-shared key can be entered by using the menu or CPS/RM.

WPA/WPA2-Enterprise Wi-Fi network

Uses certificate-based authentication.

Your radio must be pre-configured with a certificate.



NOTICE:

Check with your dealer or system administrator to connect to WPA/WPA2-Enterprise Wi-Fi network.

The programmed **Wi-Fi On or Off** button is assigned by your dealer or system administrator. Check with your dealer or system administrator to determine how your radio has been programmed.

Voice Announcements for the programmed **Wi-Fi On or Off** button can be customized through CPS according to user requirements. Check with your dealer or system administrator for more information.



NOTICE:











You can turn on or turn off Wi-Fi remotely by using a supervisory radio (see [Turning Wi-Fi On or Off by Using a Supervisory Radio](#)). Check with your dealer or system administrator for more information.

Turning Wi-Fi On or Off

Follow the procedure to turn Wi-Fi on or off.

- 1 Press the programmed **Wi-Fi On or Off** button. Voice Announcement sounds Turning On Wi-Fi or Turning Off Wi-Fi.
-

- 2 Access this feature using the menu.

- a Press  to access the menu.
 - b Press  or  to Wi-Fi and press  to select.
 - c Press  or  to Wi-Fi On and press  to select.
 - d Press  to turn on/off Wi-Fi.
 - If Wi-Fi is on, the display shows  beside Enabled.
 - If Wi-Fi is off, the  disappears from beside Enabled.
-



Turning Wi-Fi On or Off Remotely by Using a Designated Radio (Individual Control)



Follow the procedure to turn Wi-Fi on or off remotely in Individual Control (One to One).





NOTICE:

Only radio with specific CPS setting supports this function, check with your dealer or system administrator for more information.

- 1 Do one of the following:
 - Long press the programmable button. Use the keypad to enter the ID and press  to select. Proceed to [step 3](#).
 - Press  to access the menu.

- 2 Press  or  to `Contacts` and press  to select.

- 3 Press  or  to `WiFi Control` and press  to select.

- 4 Press  or  to select `On` or `Off`.

- 5 Press  to select.

If successful, the display shows a positive mini notice.

If unsuccessful, the display shows a negative mini notice.

Turning Wi-Fi On or Off Remotely by Using a Designated Radio (Group Control)



Follow the procedure to turn Wi-Fi on or off remotely in Group Control (One to Many).







NOTICE:



Only radio with specific CPS setting supports this function, check with your dealer or system administrator for more information.

- 1 Press  to access the menu.

- 2 Press  or  to `Contacts` and press  to select.

- 3 Press  or  to select the required subscriber alias or ID.

- 4 Press  or  to `WiFi Control` and press  to select.

- 5 Press  or  to select `On` or `Off`.

- 6 Press  to select.

If successful, the display shows `Sent Successfully`.

If unsuccessful, the display shows a negative mini notice.

Connecting to a Network Access Point

When you turn on Wi-Fi, the radio scans and connects to a network access point.









NOTICE:



You can also connect to a network access point using the menu.

The WPA-Enterprise Wi-Fi network access points are pre-configured. Check with your dealer or system administrator to determine how your radio has been programmed.

- 1 Press  to access the menu.

- 2 Press  or  to `WiFi` and press  to select.

- 3 Press  or  to `Networks` and press  to select.

- 4 Press  or  to a network access point and press  to select.



NOTICE:

For WPA-Enterprise Wi-Fi, if a network access point is not preconfigured, the `Connect` option is not available.

5 Press  or  to `Connect` and press  to select.

6 For WPA-Personal Wi-Fi, enter the password and press .

7 For WPA-Enterprise Wi-Fi, password is configured by using RM.

If the preconfigured password is correct, your radio automatically connects to the selected network access point.

If the preconfigured password is incorrect, the display shows `Authentication Failure`, and automatically returns to the previous menu.

If the connection is successful, the radio displays a notice and the network access point is saved into the profile list.

If the connection is unsuccessful, the radio displays shows the failure notice screen momentarily and automatically returns to the previous menu.

Checking Wi-Fi Connection Status

Follow the procedure to check the Wi-Fi Connection status.

Press the programmed **Wi-Fi Status Query** button for the connection status by using Voice Announcement. Voice Announcement sounds `Wi-Fi is Off`, `Wi-Fi is On but No Connection`, or `Wi-Fi is On with Connection`.

- The display shows `WiFi Off` when the Wi-Fi is turned off.
- The display shows `WiFi On, Connected` when the radio is connected to a network.
- The display shows `WiFi On, Disconnected` when the Wi-Fi is turned on but the radio is not connected to any network.

Voice Announcements for the Wi-Fi status query results can be customized through CPS according to user requirements. Check with your dealer or system administrator for more information.









NOTICE:

The programmed **Wi-Fi Status Query** button is assigned by your dealer or system administrator. Check with your dealer or system administrator to determine how your radio has been programmed.



Refreshing the Network List

Follow the procedure to refresh the network list.

- Perform the following actions to refresh the network list through the menu.
 - a. Press  to access the menu.
 - b. Press  or  to WiFi and press  to select.
 - c. Press  or  to Networks and press  to select.

When you enter the Networks menu, the radio automatically refreshes the network list.

- If you are already in the Networks menu, perform the following action to refresh the network list.

Press  or  to Refresh and press  to select.

The radio refreshes and displays the latest network list.

Adding a Network









NOTICE:



This task is not applicable to WPA-Enterprise Wi-Fi networks.

If a preferred network is not in the available network list, perform the following actions to add a network.

- 1 Press  to access the menu.

- 2 Press  or  to WiFi and press  to select.

- 3 Press  or  to Networks and press  to select.

- 4 Press  or  to Add Network and press  to select.

- 5 Enter the Service Set Identifier (SSID) and press .

6 Press  or  to `Open` and press  to select.



7 Enter the password and press  .
The radio displays a positive mini notice to indicate that the network is successfully saved.



Viewing Details of Network Access Points



You can view details of network access points.

1 Press  to access the menu.

2 Press  or  to `WiFi` and press  to select.

3 Press  or  to `Networks` and press  to select.

4 Press  or  to a network access point and press  to select.

5 Press  or  to `View Details` and press  to select.



NOTICE:

WPA-Personal Wi-Fi and WPA-Enterprise Wi-Fi display different details of Network Access Points.

WPA-Personal Wi-Fi

For a connected network access point, your radio displays Service Set Identifier (SSID), Security Mode, Media Access Control (MAC) address, and Internet Protocol (IP) address.

For a non-connected network access point, your radio displays SSID and Security Mode.

WPA-Enterprise Wi-Fi

For a connected network access point, your radio displays SSID, Security Mode, Identity, Extended Authentication Protocol (EAP) Method, Phase 2 Authentication, Cert Name, MAC address, IP address, Gateway, DNS1, and DNS2.

For a non-connected network access point, your radio displays SSID, Security Mode, Identity, EAP Method, Phase 2 Authentication, and Cert Name.

Removing Network Access Points









NOTICE:



This task is not applicable to Enterprise Wi-Fi networks.



Perform the following actions to remove network access points from the profile list.

- 1 Press  to access the menu.

- 2 Press  or  to `WiFi` and press  to select.

- 3 Press  or  to `Networks` and press  to select.

- 4 Press  or  to the selected network access point and press  to select.

- 5 Press  or  to `Remove` and press  to select.

- 6 Press  or  to `Yes` and press  to select.

The radio displays a positive mini notice to indicate that the selected network access point is successfully removed.

Dynamic Group Number Assignment (DGNA)

Dynamic Group Number Assignment (DGNA) is a feature which allows the console to assign and remove a new talkgroup from your radio over the air.

When the console assigns DGNA to your radio, your radio is in DGNA mode:

- A tone sounds.

- The display shows <DGNA Talkgroup Alias> Assigned momentarily before returning to the home screen.
- The DGNA icon appears in the status bar.
- The home screen displays DGNA talkgroup alias.

When the console removes DGNA from your radio, your radio returns to the previous talkgroup:

- A tone sounds.
- The display shows <DGNA Talkgroup Alias> Removed momentarily before returning to the home screen.
- The DGNA icon disappears from the status bar.
- The home screen displays the previous talkgroup alias.

Depending on how your radio is programmed, you can view, edit, and listen to the original scan lists channels and the non-DGNA talkgroups.

When your radio is in DGNA mode, pressing the PTT button allows you to communicate only with the current DGNA talkgroup. To communicate with the previous non-DGNA talkgroup, program the **One Touch Access** button. See [Making Non-DGNA Calls on page 192](#).



NOTICE:

Check with your dealer or system administrator to determine how your radio has been programmed.

Making DGNA Calls

When your radio is in DGNA mode, press the **PTT** button to make the call.

- A DGNA tone sounds.
- The display shows the DGNA icon and the DGNA talkgroup alias.



NOTICE:

If your radio is not in DGNA mode and you press the **One Touch Access** button, your radio sounds a tone, indicating error. The display remains unchanged.

Making Non-DGNA Calls

- 1 Press the programmed **One Touch Access** button.
 - A positive tone sounds.

- Voice Announcement sounds One Touch Replaced Call.
- The display shows <Talkgroup Alias> and Press PTT momentarily.

**NOTICE:**

If your radio is not in DGNA mode and you press the **One Touch Access** button, your radio sounds a negative tone, indicating error. The display remains unchanged.

-
- 2 Press **PTT** button before a negative tone sounds and your radio returns to the home screen.

**NOTICE:**

When your radio is in the home screen, a PTT press makes call to the DGNA talkgroup.

Receiving and Responding to DGNA Calls

When you receive a DGNA call:

- A DGNA tone sounds.
- The display shows the DGNA icon, DGNA talkgroup alias, and radio alias.

- Your radio unmutes and the incoming call sounds through the speaker.

- 1 Press the **PTT** button to respond to the call.

- 2 Release the **PTT** button to listen.

Utilities

This chapter explains the operations of the utility functions available in your radio.

Power Levels

You can customize the power setting to high or low for each channel.

High

This enables communication with radios located at a considerable distance from you.

Low

This enables communication with radios in closer proximity.

**NOTICE:**



This feature is not applicable in Citizens Band channels that are in the same frequency.



Setting Power Levels

Follow the procedure to set the power levels on your radio.

1 Do one of the following:

- Press the programmed **Power Level** button. Skip the steps below.
- Press  to access the menu.

2 Press  or  to Utilities. Press  to select.

3 Press  or  to Radio Settings. Press  to select.

4 Press  or  to Power. Press  to select.

5 Do one of the following:

- Press  or  to High. Press  to select.
The display shows  beside High.

- Press  or  to Low. Press  to select.
The display shows  beside Low.



6 Long press  to return to the Home screen.



Turning Radio Tones/Alerts On or Off



You can enable and disable all radio tones and alerts, if needed, except for incoming Emergency alert tone . Follow the procedure to turn tones and alerts on or off on your radio.



1 Do one of the following:

- Press the programmed **Tones/Alerts** button. Skip the following steps.
- Press  to access the menu.



2 Press  or  to Utilities. Press  to select.

3 Press  or  to Radio Settings. Press  to select.

4 Press  or  to Tones/Alerts. Press  to select.

5 Press  or  to All Tones. Press  to select.



6 Press  to enable or disable all tones and alerts. The display shows one of the following results:

- If enabled,  appears beside Enabled.
- If disabled,  disappears beside Enabled.



Turning Keypad Tones On or Off



Follow the procedure to turn keypad tones on or off on your radio.

1 Press  to access the menu.



2 Press  or  to Utilities. Press  to select.

3 Press  or  to Radio Settings. Press  to select.

4 Press  or  to Tones/Alerts. Press  to select.

5 Press  or  to Keypad Tones. Press  to select.



6 Press  to enable or disable keypad tones. The display shows one of the following results:



- If enabled,  appears beside Enabled.
- If disabled,  disappears beside Enabled.



Setting Tones/Alerts Volume Offset Levels



This feature adjusts the volume of the tones or alerts, allowing it to be higher or lower than the voice volume. Follow the procedure to set the tones and alerts volume offset levels on your radio.



- 1 Press  to access the menu.

- 2 Press  or  to Utilities. Press  to select.



- 3 Press  or  to Radio Settings. Press  to select.

- 4 Press  or  to Tones/Alerts. Press  to select.

- 5 Press  or  to Vol. Offset. Press  to select.

- 6 Press  or  to the required volume offset level.



A feedback tone sounds with each corresponding volume offset level.



- 7 Do one of the following:
 - Press  to select. The required volume offset level is saved.
 - Press  to exit. The changes are discarded.



Turning Talk Permit Tone On or Off



Follow the procedure to turn Talk Permit Tone on or off on your radio.

- 1 Press  to access the menu.

- 2 Press  or  to Utilities. Press  to select.



3 Press  or  to Radio Settings. Press  to select.

4 Press  or  to Tones/Alerts. Press  to select.

5 Press  or  to Talk Permit. Press  to select.

6 Press  to enable or disable the Talk Permit Tone.



The display shows one of the following results:



- If enabled,  appears beside Enabled.
 - If disabled,  disappears beside Enabled.
-



Turning Power Up Tone On or Off



Follow the procedure to turn Power Up Tone on or off on your radio.

1 Press  to access the menu.



2 Press  or  to Utilities. Press  to select.

3 Press  or  to Radio Settings. Press  to select.

4 Press  or  to Tones/Alerts. Press  to select.

5 Press  or  to Power Up. Press  to select.



6 Press  to enable or disable the Power Up Tone. The display shows one of the following results:



- If enabled,  appears beside Enabled.
- If disabled,  disappears beside Enabled.



Setting Text Message Alert Tones





You can customize the text message alert tone to Momentary or Repetitive for each entry in the Contacts list. Follow the procedure to set the text message alert tones on your radio.



- 1 Press  to access the menu.

- 2 Press  or  to **Contacts**. Press  to select.

- 3 Press  or  to the required alias or ID.
Press  to select.

- 4 Press  or  to **Message Alert**. Press  to select.



- 5 Do one of the following:
 - Press  or  to **Momentary**. Press  to select.
The display shows  beside **Momentary**.



- Press  or  to **Repetitive**. Press  to select.
The display shows  beside **Repetitive**.
-



Changing Display Modes

You can change the display mode of the radio between Day or Night, as needed. This feature affects the color palette of the display. Follow the procedure to change the display mode of your radio.



- 1 Do one of the following:
 - Press the programmed **Display Mode** button. Skip the following steps.
 - Press  to access the menu.

 - 2 Press  or  to **Utilities**. Press  to select.

 - 3 Press  or  to **Radio Settings**. Press  to select.
-

- 4 Press  or  to Display. Press  to select.

The display shows Day Mode and Night Mode.



- 5 Press  or  to the required setting. Press  to select.

The display shows ✓ beside the selected setting.



Adjusting Display Brightness

Follow the procedure to adjust the display brightness on your radio. Display brightness cannot be adjusted when Auto Brightness is enabled.



- 1 Do one of the following:
 - Press the programmed **Brightness** button. Skip the following steps.
 - Press  to access the menu.
-

- 2 Press  or  to Utilities. Press  to select.
-

- 3 Press  or  to Radio Settings. Press  to select.
-

- 4 Press  or  to Brightness. Press  to select.

The display shows the progress bar.

- 5 Press  or  to decrease or increase the display brightness. Press  to select.



The setting value is varied from 1 to 8.



Turning Horns/Lights On or Off



Your radio is able to notify you of an incoming call through the horns and lights feature. When activated, an incoming call sounds the horn and turns on the lights of your vehicle. This feature needs to be installed through your radio rear

accessory connector by your dealer. Follow the procedure to turn all horns and lights on or off on your radio.

- 1 Do one of the following:
 - Press the programmed **Horns/Lights** button. Skip the steps below.
 - Press  to access the menu.

- 2 Press  or  to Utilities. Press  to select.

- 3 Press  or  to Radio Settings. Press  to select.



- 4 Press  or  to Horns/Lights. Press  to select.



- 5 Press  to enable or disable Horns/Lights. The display shows one of the following results:
 - If enabled, ✓ appears beside Enabled.
 - If disabled, ✓ disappears beside Enabled.



Turning LED Indicators On or Off

Follow the procedure to turn the LED indicators on or off on your radio.

- 1 Press  to access the menu.

- 2 Press  or  to Utilities. Press  to select.

- 3 Press  or  to Radio Settings. Press  to select.



- 4 Press  or  to LED Indicator. Press  to select.



- 5 Press  to enable or disable the LED indicator. The display shows one of the following results:
 - If enabled, ✓ appears beside Enabled.
 - If disabled, ✓ disappears beside Enabled.



Turning Public Address System On or Off

Follow the procedure to enable or disable the internal public address (PA) system of your radio.

- 1 Do one of the following:
 - Press the programmed **Public Address** button. Skip the following steps.
 - Press  to access the menu.

- 2 Press  or  to Utilities. Press  to select.

- 3 Press  or  to Radio Settings. Press  to select.



- 4 Press  or  to Public Address. Press  to select.



- 5 Press  to enable or disable Public Address.
 - If enabled, ✓ appears beside Enabled.
 - If disabled, ✓ disappears beside Enabled.

Turning External Public Address System On or Off

Follow the procedure to enable or disable the external public address (PA) system of your radio.



- 1 Do one of the following:
 - Press the programmed **Ext Public Address** button. Skip the following steps.
 - Press  to access the menu.

- 2 Press  or  to Utilities. Press  to select.

3 Press  or  to Radio Settings. Press  to select.

4 Press  or  to External Public Address. Press  to select.



5 Press  to enable or disable external public address.

- If enabled,  appears beside Enabled.
 - If disabled,  disappears beside Enabled.
-



Turning Introduction Screen On or Off



You can enable and disable the Introduction Screen by following the procedure.

1 Press  to access the menu.

2 Press  or  to Utilities. Press  to select.



3 Press  or  to Radio Settings. Press  to select.

4 Press  or  to Display. Press  to select.

5 Press  or  to Intro Screen. Press  to select.

6 Press  to enable or disable the Introduction Screen.



The display shows one of the following results:



- If enabled,  appears beside Enabled.
 - If disabled,  disappears beside Enabled.
-



Setting Languages



Follow the procedure to set the languages on your radio.

- 1 Press  to access the menu.

- 2 Press  or  to Utilities. Press  to select.

- 3 Press  or  to Radio Settings. Press  to select.



- 4 Press  or  to Languages. Press  to select.



- 5 Press  or  to the required language. Press  to select.
The display shows  beside the selected language.



Identifying Cable Type

Do the following steps to select the type of cable your radio uses.

- 1 Press  to access the menu.

- 2 Press  or  to Utilities. Press  to select.

- 3 Press  or  to Radio Settings. Press  to select.

- 4 Press  or  to Cable Type. Press  to select.

- 5 The current cable type is indicated by a  .

Turning Voice Announcement On or Off

This feature enables the radio to audibly indicate the current zone or channel the user has just assigned, or the programmable button the user has just pressed.

This is typically useful when the user has difficulty reading the content shown on the display.

This audio indicator can be customized according to customer requirements. Follow the procedure to turn Voice Announcement on or off on your radio.

Turning Option Board On or Off

Option board capabilities within each channel can be assigned to programmable buttons. A channel can support up to 6 option board features. Follow the procedure to turn option board on or off on your radio.

Press the programmed **Option Board** button.

Text-to-Speech

The Text-to-Speech feature can only be enabled by your dealer or system administrator. If Text-to-Speech is enabled, the Voice Announcement feature is automatically disabled. If Voice Announcement is enabled, then the Text-to-Speech feature is automatically disabled.

This feature enables the radio to audibly indicate the following features:



- Current Channel
- Current Zone
- Programmed button feature on or off
- Content of received text messages
- Content of received Job Tickets



This audio indicator can be customized per customer requirements. This feature is typically useful when the user is in a difficult condition to read the content shown on the display.



Setting Text-to-Speech



Follow the procedure to set the Text-to-Speech feature.

- 1 Press  to access the menu.

- 2 Press  or  to Utilities. Press  to select.

- 3 Press  or  to Radio Settings. Press  to select.

- 4 Press  or  to Voice Announcement. Press  to select.

- 5 Press  or  to any of the following features. Press  to select.
The available features are as follows:
 - All
 - Messages



- Job Tickets
- Channel
- Zone
- Program Button



✓ appears beside the selected setting.



Setting Menu Timer



You can set the time your radio stays in the menu before it automatically switches to the Home screen. Follow the procedure to set the menu timer.



- 1 Press  to access the menu.

- 2 Press  or  to Utilities. Press  to select.

- 3 Press  or  to Radio Settings. Press  to select.

4 Press  or  to Display. Press  to select.

5 Press  or  to Menu Timer. Press  to select.



6 Press  or  to the required setting. Press  to select.

Turning Digital Microphone AGC On or Off



The Digital Microphone Automatic Gain Control (AGC) controls the microphone gain of the radio automatically while transmitting on a digital system.

This feature suppresses loud audio or boosts soft audio to a preset value in order to provide a consistent level of audio. Follow the procedure to turn Digital Microphone AGC on or off on your radio.

1 Press  to access the menu.



2 Press  or  to Utilities. Press  to select.

3 Press  or  to Radio Settings. Press  to select.

4 Press  or  to Mic AGC-D. Press  to select.

5 Press  to enable or disable Digital Microphone AGC.

The display shows one of the following results:

- If enabled,  appears beside Enabled.
 - If disabled,  disappears beside Enabled.
-

Turning Intelligent Audio On or Off

Your radio automatically adjusts the audio volume to overcome current background noise in the environment, inclusive of both stationary and non-stationary noise sources. This is a receive-only feature and does not affect



transmission audio. Follow the procedure to turn Intelligent Audio on or off on your radio.









NOTICE:

This feature is not applicable during a Bluetooth session.









- 1 Do one of the following:
 - Press the programmed **Intelligent Audio** button. Skip the steps below.
 - Press  to access the menu.

- 2 Press  or  to Utilities. Press  to select.

- 3 Press  or  to Radio Settings. Press  to select.

- 4 Press  or  to Intelligent Audio. Press  to select.



- 5 Do one of the following:



- Press  or  to On. Press  to select. The display shows  beside On.
- Press  or  to Off. Press  to select. The display shows  beside Off.



Turning the Acoustic Feedback Suppressor Feature On or Off



This feature allows you to minimize acoustic feedback in received calls.

- 1 Press  to access the menu.





- 2 Press  or  to Utilities and press  to select.

- 3 Press  or  to Radio Settings and press  to select.

- 4 Press  or  to AF Suppressor and press  to select.

You can also use  or  buttons to change the selected option.

- 5 Do one of the following.



- Press  to enable Acoustic Feedback Suppressor. The display shows  beside Enabled.
- Press  to disable Acoustic Feedback Suppressor. The  disappears from beside Enabled.



Turning Trill Enhancement On or Off



You can enable this feature when you are speaking in a language that contains many words with alveolar trill (rolling "R") pronunciations. Follow the procedure to turn Trill Enhancement on or off on your radio.

- 1 Do one of the following:









- Press the programmed **Trill Enhancement** button. Skip the steps below.
- Press  to access the menu.

- 2 Press  or  to Utilities. Press  to select.

- 3 Press  or  to Radio Settings. Press  to select.

- 4 Press  or  to Trill Enhance. Press  to select.

- 5 Do one of the following:

- Press  or  to On. Press  to select. The display shows  beside On.
- Press  or  to Off. Press  to select. The display shows  beside Off.

Audio Ambience

You can customize the audio ambience for your radio according to your environment.

Default

This is the default setting.

Loud

This setting enables Noise Suppressor and increases speaker loudness for use in noisy surroundings.



Work Group



This setting enables AF Suppressor and disables AGC for use when a group of radios are near to each other.



Setting Audio Ambience



Follow the procedure to set the audio ambience on your radio according to your environment.

- 1 Press  to access the menu.

- 2 Press  or  to Utilities. Press  to select.

- 3 Press  or  to Radio Settings. Press  to select.

- 4 Press  or  to Audio Ambience. Press  to select.

- 5 Press  or  to the required setting. Press  to select.

The settings are as follows.

- Choose **Default** for the default factory settings.
- Choose **Loud** to increase speaker loudness when using in noisy surroundings.
- Choose **Work Group** to reduce acoustic feedback when using with a group of radios that are near to each other.

The display shows  beside the selected setting.

Audio Profiles

You can customize the audio profiles for your radio according to your preference.

Default

This is the default setting.

Level 1, Level 2, and Level 3

These settings are intended to compensate for noise-induced hearing loss that is typical for adults in their 40's, 50's, and 60's or over.



Treble Boost, Mid Boost, and Bass Boost



These settings are intended for a tinnier sound, a more nasal sound, and a deeper sound.



Setting Audio Profiles



Follow the procedure to set audio profiles on your radio.

- 1 Press  to access the menu.

- 2 Press  or  to Utilities. Press  to select.

- 3 Press  or  to Radio Settings. Press  to select.

- 4 Press  or  to Audio Profiles. Press  to select.

- 5 Press  or  to the required setting. Press  to select.

The settings are as follows.

- Choose **Default** to disable the previously selected audio profile and return to the default factory settings.
- Choose **Level 1**, **Level 2**, or **Level 3** for audio profiles intended to compensate for noise-induced hearing loss that is typical for adults over 40 years of age.
- Choose **Treble Boost**, **Mid Boost**, or **Bass Boost** for audio profiles that align with your

preference for tinnier, more nasal, or deeper sounds.

The display shows ✓ beside the selected setting.

Turning Global Navigation Satellite System On or Off



Global Navigation Satellite System (GNSS) is a satellite navigation system that determines the radio precise location. GNSS includes Global Positioning System (GPS) and BeiDou Navigation Satellite System (BDS).





NOTICE:

Selected radio models may offer GPS and BDS. GNSS constellation is configured by using CPS. Check with your dealer or system administrator to determine how your radio has been programmed.

- 1 Do one of the following steps to toggle GNSS on or off on your radio.
 - Press the programmed **GNSS** button.
 - Press  to access the menu. Proceed to the next step.

- 2 Press  or  to Utilities. Press  to select.

- 3 Press  or  to Radio Settings. Press  to select.

- 4 Press  or  to GNSS. Press  to select.

- 5 Press  to enable or disable GNSS.
 - If enabled, ✓ appears beside Enabled.
 - If disabled, ✓ disappears beside Enabled.

General Radio Information

Your radio contains information on various general parameters.



The general information of your radio is as follows:

- Radio alias and ID.
- Firmware and Codeplug versions.
- Software update.

- GNSS information.
- Site information.







NOTICE:



Press  to return to the previous screen. Long press  to return to the Home screen. The radio exits the current screen once the inactivity timer expires.



Checking Radio Alias and ID

Follow the procedure to check the radio alias and ID on your radio.

- 1 Do one of the following:
 - Press the programmed **Radio Alias and ID** button. Skip the following steps. A positive indicator tone sounds.
You can press the programmed **Radio Alias and ID** button to return to the previous screen.
 - Press  to access the menu.
-

- 2 Press  or  to Utilities. Press  to select.
-



- 3 Press  or  to Radio Info. Press  to select.
-



- 4 Press  or  to My ID. Press  to select.
The first text line shows the radio alias. The second text line shows the radio ID.
-



Checking Firmware and Codeplug Versions

Follow the procedure to check the firmware and codeplug versions on your radio.

- 1 Press  to access the menu.
-

- 2 Press  or  to Utilities. Press  to select.
-

3 Press  or  to Radio Info. Press  to select.



4 Press  or  to Versions. Press  to select.



The display shows the current firmware and codeplug versions.



Checking Software Update Information

This feature shows the date and time of the latest software update carried out through OTAP or Wi-Fi. Follow the procedure to check the software update information on your radio.

1 Press  to access the menu.

2 Press  or  to Utilities. Press  to select.

3 Press  or  to Radio Info. Press  to select.

4 Press  or  to SW Update. Press  to select.

The display shows the date and time of the latest software update.

Software Update menu is only available after at least one successful OTAP or Wi-Fi session. See [Over-the-Air Programming on page 463](#) for more information.



Checking GNSS Information



Displays the GNSS information on your radio, such as values of:



- Latitude
- Longitude
- Altitude
- Direction
- Velocity
- Horizontal Dilution of Precision (HDOP)
- Satellites



- Version

- 1 Press  to access the menu.

- 2 Press  or  to Utilities. Press  to select.

- 3 Press  or  to Radio Info. Press  to select.



- 4 Press  or  to GNSS Info. Press  to select.



- 5 Press  or  to the required item. Press  to select. The display shows the requested GNSS information.



Displaying Site Information

Follow the procedure to display the current site name your radio is on.

- 1 Press  to access the menu.

- 2 Press  or  to Utilities. Press  to select.

- 3 Press  or  to Radio Info. Press  to select.



- 4 Press  or  to Site Info. Press  to select.

The display shows the current site name.



Viewing Enterprise Wi-Fi Certificate Details

You can view the details of the selected Enterprise Wi-Fi Certificate.

- 1 Press  to access the menu.

2 Press  or  to Utilities. Press  to select.

3 Press  or  to Certificate Menu. Press  to select.
✓ appears beside ready certificates.

4 Press  or  to the required certificate.
Press  to select.

Your radio displays the full details of the certificate.



NOTICE:

For unready certificates, the display shows only Status.

Connect Plus Operations

Additional Radio Controls in Connect Plus Mode

This chapter explains the additional radio controls available to the radio user through preprogrammed means such as programmable buttons and assignable radio functions.

Push-To-Talk (PTT) Button

The **PTT** button on the side of the radio serves two basic purposes:

- While a call is in progress, the **PTT** button allows the radio to transmit to other radios in the call.

Press and hold the **PTT** button to talk. Release the **PTT** button to listen.

The microphone is activated when the **PTT** button is pressed.

- While a call is not in progress, the **PTT** button is used to make a new call (see [Making a Radio Call on page 232](#)).

If the Talk Permit Tone is enabled, wait until the short alert tone ends before talking.

Programmable Buttons

Your dealer can program the programmable buttons as shortcuts to radio functions depending on the duration of a button press:

Short press

Pressing and releasing rapidly.

Long press

Pressing and holding for the programmed duration.



NOTICE:

The programmed duration of a button press is applicable for all assignable radio/utility functions or settings. See [Emergency Operation on page 265](#) for more information on the programmed duration of the *Emergency* button.

Assignable Radio Functions

Bluetooth® Audio Switch

Toggles audio routing between internal radio speaker and external Bluetooth-enabled accessory.

Bluetooth Connect

Initiates a Bluetooth find-and-connect operation.

Bluetooth Disconnect

Terminates all existing Bluetooth connections between your radio and any Bluetooth-enabled devices.

Bluetooth Discoverable

Enables your radio to enter Bluetooth Discoverable Mode.

Busy Queue Cancellation

Exits the busy mode when a non-Emergency call in the Busy Queue was initiated. Emergency calls, once accepted into the Busy Queue, cannot be cancelled.

Call Log

Selects the call log list.

Channel Announcement

Plays zone and channel announcement voice messages for the current channel.

Contacts

Provides direct access to the Contacts list.

Emergency On/Off

Depending on the programming, initiates or cancels an emergency.

Horns/Lights

Toggles horns and lights feature on or off.

Indoor Location

Toggles Indoor Location on or off.

Intelligent Audio

Toggles intelligent audio on or off.

Manual Dial

Depending on the programming, initiates a Private or Phone Call by keying in any subscriber ID or phone number.

One Touch Access

Directly initiates a predefined Private Call, a Call Alert, a Quick Text message, or Home Revert.

Privacy

Toggles privacy on or off.

Radio Check

Determines if a radio is active in a system.

Radio Enable

Allows a target radio to be remotely enabled.

Radio Disable

Allows a target radio to be remotely disabled.

Remote Monitor

Turns on the microphone of a target radio without it giving any indicators.

Reset Home Channel

Sets a new home channel.

Ring Alert Type

Provides direct access to the Ring Alert Type Setting.

Roam Request

Requests to search for a different site.

Scan

Toggles scan on or off.

Silence Home Channel Reminder

Mutes the Home Channel Reminder.

Site Lock On/Off

When toggled on, the radio searches the current site only. When toggled off, the radio searches other sites in addition to the current site.

Text Message

Selects the text message menu.

Voice Announcement On/Off

Toggles voice announcement on or off.

Wi-Fi

Toggles Wi-Fi on or off.

Zone

Allows selection from a list of zones.

Assignable Settings or Utility Functions

AF Suppressor

Toggles the Acoustic Feedback Suppressor feature on or off.

All Tones/Alerts

Toggles all tones and alerts on or off.

Backlight Brightness

Adjusts the brightness level.

Channel Up/Down

Depending on the programming, changes channel to previous or next channel.

Display Mode

Toggles the day/night display mode on or off.

Global Navigation Satellite System (GNSS)

Toggles the satellite navigation system on or off.

Power Level

Toggles transmit power level between high and low.

Unassigned

Indicates that the button function has not yet been assigned.

Identifying Status Indicators in Connect Plus Mode







Display Icons







The following are icons that appear on the display of the radio.

	Received Signal Strength Indicator (RSSI)
The number of bars displayed represents the radio signal strength. Four bars indicate the strongest signal. This icon is only displayed while receiving.	
	Bluetooth Not Connected







The Bluetooth feature is enabled but there is no remote Bluetooth device connected.	
	Bluetooth Connected The Bluetooth feature is enabled. The icon stays lit when a remote Bluetooth device is connected.
	High Volume Data Radio is receiving high volume data and channel is busy.
	Indoor Location Available ⁴ Indoor location status is on and available.
	Indoor Location Unavailable ⁴ Indoor location status is on but unavailable due to Bluetooth disabled or Beacons Scan suspended by Bluetooth.
	Mute Mode Mute Mode is enabled and speaker is muted.





⁴ Only applicable for models with the latest software and hardware

	Notification Notification List has items to review.
	Power Level Radio is set at Low power or Radio is set at High power.
	Tones Disable Tones are turned off.
	Option Board The Option Board is enabled.
	Option Board Non-Function The Option Board is disabled.
	GNSS Available The GPS/GNSS feature is enabled. The icon stays lit when a position fix is available.
	GNSS Not Available/Out of Range

	BeiDou Only Available ⁵ BeiDou Only feature is enabled. The icon stays lit when a position fix is available.
	Scan Scan feature is enabled.
	Emergency Radio is in Emergency mode.
	Secure The Privacy feature is enabled.
	Unsecure The Privacy feature is disabled.
	Site Roaming The site roaming feature is enabled.
	Contact

⁵ Only applicable for XiR M8660i/XiR M8668i/CM7668i

	Radio contact is available.
	Call Log Radio call log.
	Message Incoming message.
	Ring Only Ringing mode is enabled.
	Silent Ring Silent ring mode is enabled.
	Vibrate Vibrate mode is enabled.
	Vibrate and Ring Vibrate and Ring mode is enabled.
	Wi-Fi Excellent ⁶ Wi-Fi signal is excellent.

	Wi-Fi Good ⁶ Wi-Fi signal is good.
	Wi-Fi Average ⁶ Wi-Fi signal is average.
	Wi-Fi Poor ⁶ Wi-Fi signal is poor.
	Wi-Fi Unavailable ⁶ Wi-Fi signal is unavailable.

Call Icons

The following icons appear on your radio display during a call. These icons also appear in the Contacts list to indicate ID type.

	Private Call
---	---------------------

⁶ Only applicable for XiR M8668i/CM7668i

Indicates a Private Call in progress. In the Contacts list, it indicates a subscriber alias (name) or ID (number).



Group Call/Site All Call

Indicates a Group Call or Site All Call in progress. In the Contacts list, it indicates a group alias (name) or ID (number).



Phone Call as Private Call

Indicates a Phone Call as Private Call in progress.



Bluetooth PC Call

Indicates a Bluetooth PC Call in progress.

In the Contacts list, it indicates a Bluetooth PC Call alias (name) or ID (number).



Dispatch Call

The Dispatch Call contact type is used to send a text message to a dispatcher PC through a third-party Text Message Server.

Advanced Menu Icons

The following icons appear beside menu items that offer a choice between two options or as an indication that there is a sub-menu offering two options.



Checkbox (Empty)

Indicates the option is not selected.



Checkbox (Checked)

Indicates the option is selected.











Solid Black Box

Indicates the option selected for the menu item with a sub-menu.

Sent Item Icons



The following icons appear at the top right corner of the radio display in the Sent Items folder.

 OR 	<p>Sent Successfully The text message is sent successfully.</p>
 OR 	<p>In-Progress</p> <ul style="list-style-type: none"> • The text message to a group alias or ID is pending transmission. • The text message to a subscriber alias or ID is pending transmission, followed by waiting for acknowledgement.
 OR 	<p>Individual or Group Message Read The text message has been read.</p>

OR 	<p>Individual or Group Message Unread The text message has not been read.</p>
 OR 	<p>Send Failed The text message has not been sent.</p>

Bluetooth Device Icons

The following icons also appear next to items in the list of Bluetooth-enabled devices available to indicate the device type.

	<p>Bluetooth Data Device Bluetooth-enabled data device, such as a scanner.</p>
	<p>Bluetooth Audio Device Bluetooth-enabled audio device, such as a headset.</p>



Bluetooth PTT Device

Bluetooth-enabled PTT device, such as a PTT-Only Device (POD).

LED Indicator

The LED indicator shows the operational status of your radio.

Blinking red	Radio is transmitting at low battery condition, receiving an emergency transmission or has failed the self-test upon powering up, or has moved out of range if radio is configured with Auto-Range Transponder System. Mute Mode is enabled.
Rapidly blinking red	Radio is receiving over-the-air file transfer (Option Board firmware file, Network Frequency file or Option Board Codeplug file) or upgrading to a new Option Board firmware file.
Blinking green and yellow	Radio is receiving a Call Alert, received a text message or Scan is enabled and is receiving activity.

Solid yellow	Radio is in Bluetooth Discoverable Mode.
Double blinking yellow	Radio is actively searching for a new site.
Blinking yellow	Radio is receiving a Call Alert or Scan is enabled and is idle (radio will remain muted to any activity).
Solid green	Radio is powering up or transmitting.
Blinking green	Radio is powering up, receiving a call or data.
Double blinking green	Radio is receiving a privacy-enabled call.

Indicator Tones

The following are the tones that sound through the radio speaker.



High pitched tone



Low pitched tone





Indicator tones provide you with audible indications of the status after an action to perform a task is taken.

	Positive Indicator Tone
	Negative Indicator Tone

Alert Tones

Alert tones provide you with audible indications of the status, or response to data received on the radio.

Continuous Tone 	A monotone sound. Sounds continuously until termination.
Periodic Tone 	Sounds periodically depending on the duration set by the radio. Tone starts, stops, and repeats itself.
Repetitive Tone 	A single tone that repeats itself until it is terminated by the user.

Momentary Tone



Sounds only once for a short period of time defined by the radio.

Switching Between Connect Plus and Non-Connect Plus Modes

To switch to a non-Connect Plus mode, you must change to another zone, if programmed by your dealer or system administrator. Check with your dealer or system administrator to see if your radio has been programmed with non-Connect Plus zones, and what features are available while operating in non-Connect Plus zones.

Making and Receiving Calls in Connect Plus Mode

This section explains general radio operations and call features that are available in your radio.

Selecting a Site

A site provides coverage for a specific area. A Connect Plus site has a site controller and a maximum of 15 repeaters. In a multi-site network, the Connect Plus radio

will automatically search for a new site when the signal level from the current site drops to an unacceptable level.

Roam Request

A Roam Request tells the radio to search for a different site, even if the signal from the current site is acceptable.

If there are no sites available:

- The radio displays `Searching` and `Selected Channel Alias` and continues to search through the list of sites.
- The radio will return to the previous site, if the previous site is still available.



NOTICE:

This is programmed by your dealer.

Press the programmed **Roam Request** button.

You hear a tone, indicating the radio has switched to a new site. The display shows `Site ID <Site Number>`.

Site Lock On/Off

When toggled on, the radio searches the current site only. When toggled off, the radio searches other sites in addition to the current site.

Press the programmed **Site Lock** button.

If the **Site Lock** function is toggled on:

- You hear a positive indicator tone, indicating the radio has locked to the current site.
- The display shows `Site Locked`.

If the **Site Lock** function is toggled off:

- You hear a negative indicator tone, indicating the radio is unlocked.
 - The display shows `Site Unlocked`.
-

Site Restriction

Your Connect Plus radio system administrator has the ability to decide which network sites your radio is and is not allowed to use. Your radio does not need to be reprogrammed to change the list of allowed and disallowed sites. If your radio attempts to register at a disallowed site,

you see a brief message stating: Site <number given> Not Allowed. The radio then searches for a different network site.





Selecting a Zone

The radio can be programmed with a maximum of 16 Connect Plus Zones and each Connect Plus zone contains a maximum of 16 assignable positions on the Channel Selector Knob.

Each assignable knob position can be used to start one of the following voice call types:

- Group Call
- Multi-group Call
- Site All Call
- Private Call

1 Access the Zone feature by performing the following:

Radio Controls	Steps
Programmed Zone Selection button	Press the programmed Zone Selection button.
Radio menu	<p>a Press  to access the menu.</p> <p>b Press  or  to Zone and press  to select.</p>

The current zone is displayed and indicated by a ✓.

2 Select the required zone.

Radio Control	Steps
 or 	Press  or  and scroll to the required zone.

- 3 Press  to select.

The display shows <Zone> Selected momentarily and returns to the selected zone screen.

Using Multiple Networks

If your radio has been programmed to use multiple Connect Plus networks, you can select a different network by switching to the Connect Plus zone that is assigned to the desired network. These network-to-zone assignments are configured by your dealer through radio programming.

Selecting a Call Type

Use the Channel Selector Knob to select a call type. This can be a Group Call, Multi-group Call, Site All Call or Private Call, depending on how your radio is programmed. If you change the Channel Selector Knob to a different position (that has a call type assigned to it), this causes the radio to re-register with the Connect Plus site. The radio registers with the Registration Group ID that has been programmed for the new Channel Selector Knob position call type.

If you select a position that has no call type assigned to it, your radio sounds a continuous tone and the display shows Unprogrammed. Your radio does not operate when selected to an unprogrammed channel, use the Channel Selector Knob to select a programmed channel instead.

Once the required zone is displayed (if you have multiple zones in your radio), turn the programmed Channel Selector Knob to select the call type.

Receiving and Responding to a Radio Call

Once the channel, subscriber ID or call type is displayed, you can proceed to receive and respond to calls.

The LED lights up solid green while the radio is transmitting and blinks green when the radio is receiving.

**NOTICE:**

The LED lights up solid green while the radio is transmitting and double blinks green when the radio is receiving a privacy-enabled call. To unscramble a privacy-enabled call, your radio must have the same Privacy Key, OR the same Key Value and Key ID (programmed by your dealer), as the transmitting radio (the radio you are receiving the call from).

See [Privacy on page 284](#) for more information.

Receiving and Responding to a Group Call

To receive a call from a group of users, your radio must be configured as part of that group.

When you receive a Group Call (while on the Home screen), the LED blinks green. The Group Call icon appears in the top right corner. The first text line shows the caller alias. The second text line displays the group call alias.

Your radio unmutes and the incoming call sounds through the radio speaker.

- 1 Hold the microphone 1 to 2 inches (2.5 to 5.0 cm) from your mouth.

The LED lights up solid green.

- 2 Wait for one of the Talk Permit Tone to finish (if enabled), and speak clearly into the microphone.
-

- 3 Release the **PTT** button to listen.

If there is no voice activity for a predetermined period of time, the call ends.

**NOTICE:**

See [Making a Group Call on page 233](#) for details on making a Group Call.

Receiving and Responding to a Private Call

A Private Call is a call from an individual radio to another individual radio.

When you receive a Private Call, the LED blinks green. The first line of the display shows the subscriber alias or ID, and the RSSI icon. The second line displays `Private Call` and the Private Call icon. Your radio unmutes and the incoming call sounds through the speaker of the radio.

- 1 Hold the microphone 1 to 2 inches (2.5 to 5.0 cm) from your mouth.

- 2 Press the **PTT** button to respond to the call.
The LED lights up solid green.

- 3 Wait for the Talk Permit Tone to finish (if enabled), and speak clearly into the microphone.

- 4 Release the **PTT** button to listen.

If there is no voice activity for a predetermined period of time, the call ends.

The display shows `Call Ended`.

See [Making a Private Call on page 234](#) for details on making a Private Call.

Receiving a Site All Call

A Site All Call is a call from an individual radio to every radio on the site. It is used to make important announcements requiring the user's full attention.

When you receive an Site All Call, a tone sounds and the LED blinks green.

The Group Call icon appears in the top right corner. The first text line shows the caller alias. The second text line displays `Site All Call`. Your radio unmutes and the incoming call sounds through the radio speaker.

Once the Site All Call ends, the radio returns to the previous screen before receiving the call. A Site All Call does not wait for a predetermined period of time before ending.

You cannot respond to a Site All Call.



NOTICE:

See [Making a Site All Call on page 234](#) for details on making a Site All Call.

The radio stops receiving the Site All Call if you switch to a different channel while receiving the call. During a Site All Call, you will not be able to use any programmed button functions until the call ends.

Receiving an Inbound Private Phone Call

When you receive an Inbound Private Phone Call, the Phone Call as Private Call icon appears in the top right corner. The first text line shows Phone Call.

- 1 Press and hold the **PTT** button to answer and talk. Release the **PTT** button to listen.
-



- 2 Long press  to end the call.

The first line of the display shows Ending. The second line of the display shows Phone Call.... The display returns to the Phone Call screen. The display shows Phone Call Ended.

Making a Buffered Over-Dial in an Inbound Phone Private Call

During the call, the Phone Call as Private Call icon appears in the top right corner. The first text line of the display shows Phone Call.

- 1 Use the keypad to enter the digits and press the  button.

Press  followed by  within 2 seconds to insert a pause. The P replaces * and # on the display.

The Phone Call as Private Call icon appears in the top right corner. The first text line of the display shows the entered digits.

- 2 Long press  to end the call.

The first line of the display shows Ending. The second line of the display shows Phone Call.... The display returns to the Phone Call screen.

The display shows Phone Call Ended.

Making a Live Over-Dial in an Inbound Phone Private Call

During the call, the Phone Call as Private Call icon appears in the top right corner. The first text line of the display shows `Phone Call`.

- 1 Press the **PTT** button and use the keypad to enter the digits.

The Phone Call as Private Call icon appears in the top right corner. The first text line of the display shows the Live Dial digits.

- 2 Long press  to end the call.

The first line of the display shows `Ending`. The second line of the display shows `Phone Call....`. The display returns to the Phone Call screen.

The display shows `Phone Call Ended`.

Receiving an Inbound Phone Talkgroup Call

When you receive an Inbound Phone Talkgroup Call, the Group Call icon appears in the top right corner. The first text line shows `Call11`.

Press the **PTT** button to talk and release it to listen.

Inbound Phone Multi-Group Call

When you receive an Inbound Phone Multi-Group Call, the Group Call icon appears in the top right corner. The first text line shows `Multigroup Call`. The radio unmutes and the incoming multi-group call sounds through the radio speaker.

Making a Radio Call

After selecting your channel, you can select a subscriber alias or ID, or group alias or ID by using:

- The Channel Selector Knob.
- A programmed **One Touch Access** button – The One Touch Access feature allows you to make a Private Call to a predefined ID easily. This feature can be assigned

to a short or long programmable button press. You can only have one ID assigned to a **One Touch Access** button. Your radio can have multiple **One Touch Access** buttons programmed.

- The Contacts list (see [Contacts Settings on page 254](#)).



NOTICE:

Your radio must have the Privacy feature enabled on the channel to send a privacy-enabled transmission. Only target radios with the same Key Value and Key ID as your radio will be able to unscramble the transmission.

See [Privacy on page 284](#) for more information.

Making a Call with the Channel Selector Knob

This feature allows the radio users to make different call types : Group Call, Private Call, Site All Call, Multi-group Call.

Making a Group Call

To make a call to a group of users, your radio must be configured as part of that group.

1 Select the channel with the active group alias or ID. See [Selecting a Call Type on page 228](#).

2 Hold the microphone 1 to 2 inches (2.5 to 5.0 cm) from your mouth.

3 Press the **PTT** button to make the call.

The LED lights up solid green. The Group Call icon appears in the top right corner. The first text line shows the group call alias.

4 Wait for the Talk Permit Tone to finish (if enabled), and speak clearly into the microphone.

5 Release the **PTT** button to listen.

When the target radio responds, the LED blinks green, the radio unmutes and the response sounds through the radio speaker. You see the Group Call icon, the group alias or ID, and transmitting radio alias or ID on your display.

If there is no voice activity for a predetermined period of time, the call ends. Radio returns to the screen you were on prior to initiating the call.

Making a Private Call

While you can receive and/or respond to a Private Call initiated by an authorized individual radio, your radio must be programmed for you to initiate a Private Call.

You will hear a negative indicator tone, when you make a Private Call using the **One Touch Access** button, or the Channel Selector Knob, if this feature is not enabled.

- 1 Do one of the following.
 - Select the channel with the active subscriber alias or ID. See [Selecting a Call Type on page 228](#).
 - Press the programmed **One Touch Access** button.
-

- 2 Hold the microphone 1 to 2 inches (2.5 to 5.0 cm) from your mouth.
-

- 3 Press the **PTT** button to make the call.

The LED lights up solid green. The Private Call icon appears on the top right corner. The first text line shows the target subscriber alias. The second text line displays the call status.

- 4 Wait for the Talk Permit Tone to finish (if enabled), and speak clearly into the microphone.
-

- 5 Release the **PTT** button to listen.

When the target radio responds, the LED blinks green.

If there is no voice activity for a predetermined period of time, the call ends. You hear a short tone. The display shows `Call Ended`.

Your radio may be programmed to perform a radio presence check prior to setting up the Private Call. If the target radio is not available, you hear a short tone and see negative mini notice on the display.

Making a Site All Call

This feature allows you to transmit to all users on the site that are currently not engaged in another call. Your radio must be programmed to allow you to use this feature.

Users on the channel/site cannot respond to an Site All Call.

- 1 Select the channel with the active Site All Call group alias. See [Selecting a Call Type on page 228](#).
-

- 2 Hold the microphone 1 to 2 inches (2.5 to 5.0 cm) from your mouth.
-
- 3 Press the **PTT** button to make the call.
The LED lights up solid green. The Group Call icon appears in the top right corner. The first text line shows `Site All Call`.
-
- 4 Wait for the Talk Permit Tone to finish (if enabled), and speak clearly into the microphone.
-

Making a Multi-group Call

This feature allows you to transmit to all users on multiple groups. Your radio must be programmed to allow you to use this feature.



NOTICE:

Users on the groups cannot respond to a Multi-group Call.

- 1 Turn the Channel Selector Knob to select the Multi-group alias or ID.
-

- 2 Press the **PTT** button to make the call.

The LED lights up solid green. The display shows the Multi-group alias or ID.

Wait for the Talk Permit Tone to finish (if enabled) and speak clearly into the microphone.

Making a Private Call with a One Touch Call Button



NOTICE:

Programmable buttons press must be initiated from the Home screen.

The One Touch Call feature allows you to easily make a Private Call to a pre-defined Private Call alias or ID. This feature can be assigned to a short or long programmable button press.

You can **ONLY** have one alias or ID assigned to a One Touch Call button. Your radio can have multiple One Touch Call buttons programmed.

- 1 Press the programmed **One Touch Call** button to make a Private Call to the pre-defined Private Call alias or ID.
-

- 2 Hold the microphone 1 to 2 inches (2.5 to 5.0 cm) from your mouth.
-

- 3 Press the **PTT** button to make the call.
The LED lights up solid green.
The display shows the Private Call alias or ID.
-

- 4 Wait for the Talk Permit Tone to finish (if enabled) and speak clearly into the microphone.
-

- 5 Release the **PTT** button to listen.
When the target radio responds, the LED blinks green.
If there is no voice activity for a predetermined period of time, the call ends.
-

Making a Call with the Programmable Manual Dial Button

This feature allows the radio users to make private calls using the programmable manual dial button.

Making a Private Call

- 1 Press the programmed **Manual Dial** button to enter into the Manual Dial screen.

The display shows `Number: .`

- 2 Use the keypad to enter a subscriber alias or Private ID.
-

- 3 Hold the microphone 1 to 2 inches (2.5 to 5.0 cm) from your mouth.
-

- 4 Press the **PTT** button to make the call.
The LED lights up solid green. The Private Call icon appears in the top right corner. The first text line shows the subscriber alias. The second text line displays the call status.
-

- 5 Wait for the Talk Permit Tone to finish (if enabled) and speak clearly into the microphone.
-

- 6 Release the **PTT** button to listen.

When the target radio responds, the LED blinks green.



If there is no voice activity for a predetermined period of time, the call ends. You hear a short tone. The display shows `Call Ended`.

Making an Outbound Private Phone Call with the Programmable Manual Dial Button

- 1 Press the programmed **Manual Dial** button to enter into the Manual Dial screen.

The display shows `Number:.`

- 2 Use the keypad to enter a telephone number, and press  to place a call to the entered number.

Press  to delete any unwanted characters. Press  followed by  within 2 seconds to insert a pause. The P replaces * and # on the display.

If successful, the first line of the display shows `Phone Call`. The second line of the display shows the dialed telephone number.

If an invalid telephone number is selected, the display shows a negative mini notice, `Phone Call Failed, Resource Not Available, or Invalid Permissions`.



If  is pressed with no telephone number entered, the radio sounds a positive indicator tone then a negative indicator tone. The display remains the same.

- 3 Long press  to end the call.

The first line of the display shows `Ending`. The second line of the display shows `Phone Call....`



The display shows `Phone Call Ended`.

Making an Outbound Private Phone Call via the Phone Menu

- 1 Press  to access the menu.
-
- 2 Press  or  to Phone and press  to select.
-

- 3 Press  to select Manual Dial.
The first line of the display shows Number, the second line of the display shows a blinking cursor.
-

- 4 Use the keypad to enter a telephone number, and press  to place a call to the entered number.

Press  to delete any unwanted characters. Press  followed by  within 2 seconds to insert a pause. The P replaces * and # on the display.

If successful, the first line of the display shows Phone Call. The second line of the display shows the dialed telephone number.

If an invalid telephone number is selected, the display shows a negative mini notice, Phone Call Failed, Resource Not Available, or Invalid Permissions.

If  is pressed with no telephone number entered, the radio sounds a positive indicator tone then a negative indicator tone. The display remains the same.

-
- 5 Long press  to end the call.
The first line of the display shows Ending. The second line of the display shows Phone Call....
The display shows Phone Call Ended.
-



Making an Outbound Private Phone Call from Contacts









NOTICE:

If the Phone Manual Dial is disabled in MOTOTRBO Connect Plus Option Board CPS, the Phone Number item will **not** be displayed in the Menu.

- 1 Press  to access the menu.



- 2 Press  or  to `Contacts` and press  to select.

- 3 Press  or  to `Manual Dial` and press  to select.

- 4 Press  or  to `Phone Number` and press  to select.

The first line of the display shows `Number`, the second line of the display shows a blinking cursor.

- 5 Use the keypad to enter a telephone number, and press  to place a call to the entered number.
If the **PTT** button is pressed, the display shows a negative mini notice, `Press OK to Send` and returns to the previous screen.

Press  to delete any unwanted characters. Press  followed by  within 2 seconds to insert a pause. The `P` replaces `*` and `#` on the display.

If successful, the first line of the display shows `Phone Call`. The second line of the display shows the dialed telephone number.

If  is pressed with no telephone number entered, the radio sounds a positive indicator tone then a negative indicator tone. The display remains the same.

- 6 Long press  to end the call.

The first line of the display shows `Ending`. The second line of the display shows `Phone Call....`

The display shows `Phone Call Ended`.

Waiting for the Channel Grant in an Outbound Private Phone Call

When you make a Private Phone Call, the first line of the display shows `Phone Call`. The second line of the display shows the dialed telephone number.

When the call is connected, the Phone Call as Private Call icon appears in the top right corner. The first line of the display shows the telephone number.

If unsuccessful, the display shows a negative mini notice, `Phone Call Failed, Resource Not Available, or Invalid Permissions`.

Long press  to end the call.



The display returns to the previous screen.

Making a Buffered Over-Dial in a Connected Outbound Private Phone Call

During the call, the Phone Call as Private Call icon appears in the top right corner. The first text line of the display shows the telephone number.

- 1 Use the keypad to enter the digits.

Press  to delete any unwanted characters. Press

 followed by  within 2 seconds to insert a pause. The P replaces * and # on the display.

The first text line of the display shows `Extra Digits`, the second text line of the display shows the entered extra digits.



- 2 Press the  button.

If the **PTT** button is pressed, the display shows a negative mini notice, `Press OK to Send` and returns to the previous screen.

The Phone Call as Private Call icon appears in the top right corner. The first text line of the display

shows the telephone number with the over-dial digits appended.

3 Do one of the following.

- Press  to return to the Phone Call screen.
 - Long press  to end the call.
-

Making a Live Over-Dial in a Connected Outbound Private Phone Call

During the call, the Phone Call as Private Call icon appears in the top right corner. The first text line of the display shows the telephone number.

- 1 Press the **PTT** button and use the keypad to enter the digits.

The Phone Call as Private Call icon appears in the top right corner. The first text line of the display shows the telephone number with the over-dial digits appended.

- 2 Long press  to end the call.

The first line of the display shows `Ending`. The second line of the display shows `Phone Call....`

The display shows `Phone Call Ended`.

Advanced Features in Connect Plus Mode

This chapter explains the operations of the features available in your radio.

Home Channel Reminder

This feature provides a reminder when the radio is not set to the home channel for a period of time.

If this feature is enabled by using the CPS, the Home Channel Reminder tone and announcement sound, the first line of the display shows `Non` and the second line shows `Home Channel` periodically when the radio is not set to the home channel for a period of time.

You can respond to the reminder by performing one of the following actions:

- Return to the home channel.
- Mute the reminder temporarily by using the programmable button.
- Set a new home channel by using the programmable button.

Auto Fallback

Auto Fallback is a system feature that allows you to continue to make and receive non-emergency calls on the selected Group Contact in the event of certain types of Connect Plus system failures.

If one of these failures occurs, your radio attempts to roam to a different Connect Plus site. This search process may result in your radio finding an operable Connect Plus site, or it may result in your radio finding a “Fallback Channel” (if your radio is enabled for Auto Fallback). A Fallback Channel is a repeater that is normally part of an operable Connect Plus site, but is currently unable to communicate with either its site controller or the Connect Plus network. In Fallback mode, the repeater operates as a single digital repeater. Auto Fallback Mode supports non-emergency Group Calls only. No other call types are supported in Fallback Mode.

Indications of Auto Fallback Mode

When your radio is using a Fallback channel, you hear the intermittent “Fallback Tone” approximately once every 15 seconds (except while transmitting). The display periodically shows a brief message, “Fallback Channel”. Your radio only permits PTT on the selected Group Contact (Group Call, Multigroup Call, or Site All Call). It does not allow you to make other types of calls.

Making/Receiving Calls in Fallback Mode



NOTICE:

Calls are heard only by radios that are monitoring the same Fallback channel and selected to the same Group. Calls are not networked to other sites or other repeaters.

Emergency voice calls or Emergency Alerts are not available in Fallback mode. If you press the emergency button in Fallback mode, the radio provides an invalid key press tone. Display-equipped radios also show the message, "Feature not available".

Private (radio to radio) and Phone calls are not available in Fallback mode. If you attempt a call to a private contact, you will receive a denial tone. At this point you should select a desired group contact. Other non-supported calls include Remote Monitor, Call Alert, Radio Check, Radio Enable, Radio Disable, Text messaging, Location Updates, and packet data calls.

Enhanced Traffic Channel Access (ETCA) is not supported in Auto Fallback mode. If two or more radio users press **PTT** at the same time (or at

almost the same time), it is possible that both radios transmit until **PTT** is released. In this event, it is possible that none of the transmissions will be understood by receiving radios.

Making calls in Fallback mode is similar to normal functioning. Simply select the group contact you wish to use (using the radio's normal channel selection method), and then press the **PTT** to start your call. It is possible that the channel may be in use already by another group. If the channel is in use, you receive a busy tone and the display will say "Channel Busy". You may select Group, Multi-group or Site All Call contacts using your radio's normal channel selection method. While the radio is operating on the Fallback Channel, the Multigroup operates just like other Groups. It is only heard by radios that are currently selected to the same Multi-group.

Returning to Normal Operation

If the site returns to normal trunking operation while you are in range of your Fallback repeater, your radio automatically exits Auto Fallback mode. You hear a registration "beep" when the radio successfully registers. If you are in the range of an operable site (that is not in Fallback mode), you may press the Roam Request button (if programmed for your radio) to force your radio to search for and register on

an available site. If no other site is available, your radio returns to Auto Fallback mode after searching is complete. If you drive out of coverage of your Fallback repeater, your radio enters Search mode (display indicates Searching).

Radio Check













If enabled, this feature allows you to determine if another radio is active in a system without disturbing the user of that radio. No audible or visual notification is shown on the target radio.

This feature is only applicable for subscriber aliases or IDs.

Sending a Radio Check

- 1 Access the Radio Check feature.

Radio Control	Steps
Programmed Radio Check button	a Press the programmed Radio Check button.

Radio Control	Steps
	b Press  or  to the required subscriber alias or ID and press  to select.
Menu	<p>a Press  to access the menu.</p> <p>b Press  or  to Contacts and press  to select.</p> <p>c Press  or  to the required subscriber alias or ID and press  to select.</p> <p>d Press  or  to Radio Check and press  to select.</p>

The display shows the Target Alias, indicating the request is in progress. The LED lights up solid green.

2 Wait for acknowledgment.

If the target radio is active in the system, a tone sounds and the display briefly shows `Target Radio Available`.

If the target radio is not active in the system, a tone sounds and the display briefly shows `Target Radio Not Available`.

Radio returns to the subscriber alias or ID screen when initiated via Menu.

Radio returns to the Home Screen if initiated via the programmable button.

Remote Monitor

Use the Remote Monitor feature to turn on the microphone of a target radio (subscriber alias or IDs only). The green LED will blink once on the target subscriber. You can use this feature to monitor, remotely, any audible activity surrounding the target radio.

Your radio must be programmed to allow you to use this feature.







Initiating Remote Monitor











NOTICE:

Remote Monitor automatically stops after a programmed duration or when there is any attempt to initiate transmission, change channels or power down the radio.

1 Access the Remote Monitor feature.

Radio Control	Steps
Programmed Remote Monitor Button	<p>a Press the programmed Remote Monitor button.</p> <p>b Press  or  to the required subscriber alias or ID and press  to select.</p>
Menu	<p>a Press  to access the menu.</p> <p>b Press  or  to Con-tacts and press  to select.</p>

Radio Control	Steps
	<p>c Press  or  to the required subscriber alias or ID and press  to select.</p> <p>d Press  or  to Manual Dial and press  to select.</p> <p>e Press  or  to Remote Mon. and press  to select.</p>

The first text line shows Rem. Monitor. The second text line displays the Target Alias, indicating the request is in progress. The LED lights up blinking green.

2 Wait for acknowledgment.

If successful, a positive indicator tone sounds and the display momentarily shows Rem. Monitor Successful. Your radio starts playing audio from the monitored radio for a programmed duration and

display shows Rem. Monitor, followed by target alias. Once the timer expires, the radio sounds an alert tone and the LED turns off.

If unsuccessful, the radio sounds a negative indicator tone the display shows Rem. Monitor Failed.

Scan

This feature allows your radio to monitor and join calls for groups defined in a pre-programmed scan list. When scan is enabled, the scan icon appears on the status bar and the LED blinks yellow when idle.

Starting and Stopping Scan









NOTICE:

This procedure turns the Scan feature On or Off for all Connect Plus zones with the same Network ID as your currently selected zone. It is important to note that even when the Scan feature is turned on via this procedure, scan may still be disabled for some (or all) groups on your scan list. See [Editing the Scan List on page 249](#) for more information.

You can start and stop scanning by pressing the programmed **Scan** button **OR** follow the procedure described next.

- 1 Press  to access the menu.

- 2 Press  or  to Scan and press  to select.

- 3 Press  or  to Turn On or Turn Off and press  to select.
 - The display shows Scan On if scan is enabled.
 - The Scan menu shows Turn Off if scan is enabled.
 - The display shows Scan Off if scan is disabled.
 - The Scan menu shows Turn On if scan is disabled.

Responding to a Transmission During a Scan

During scanning, your radio stops on a group where activity is detected. The radio continuously listens for any member in the scan list when idle on the control channel.

- 1 Hold the microphone 1 to 2 inches (2.5 to 5.0 cm) from your mouth.

- 2 Press the **PTT** button during hang time.
The LED lights up solid green.

- 3 Wait for the Talk Permit Tone to finish (if enabled), and speak clearly into the microphone.

- 4 Release the **PTT** button to listen.
If you do not respond within the hang time, the radio returns to scanning other groups.

User Configurable Scan

If the Edit List menu is enabled, a user is able to Add and Remove the scan members from the Add Member menu. A

Scan List member must be a regular Group Contact (for example, not Multi-group or Site All Call/Network Wide All Call) that is currently assigned to a Channel Selector position in a Connect Plus Zone with the same Network ID as the currently selected Zone. The Talkgroup alias must not match any Talkgroup that has been included in the current Zone Scan List.

Scan can be turned on or off from the menu or by pressing a programmed **Scan On/Off** button.

This feature functions only when the radio is not currently involved in a call. If you are presently listening to a call, your radio cannot scan for other group calls, and is therefore unaware they are in progress. Once your call is finished, your radio returns to the control channel time slot and is able to scan for groups that are in the scan list.

Turning Scan On or Off







NOTICE:



This procedure turns the Scan feature On or Off for all zones with the same Network ID as your currently selected zone. It is important to note that even when the Scan feature is turned on via this procedure, scan may still be disabled for some (or all) groups on your scan list. See the next section for more information.

If Scan is turned on, the Scan icon appears on your display. When Scan is on and you are not participating in a call, the LED blinks green and yellow.

The procedure for turning Scan on or off depends on how your radio is programmed. If programmed with a Scan On/Off button, use the button to toggle the feature on or off. If your radio has been programmed so that Scan can be turned on or off via the menu, follow the procedure described next.

- 1 Press  to access the menu.

- 2 Press  or  to Scan and press  to select.

- 3 Press  or  to Turn On or Turn Off and press  to select.
- The display shows `Scan On` momentarily if scan is disabled.
 - The display shows `Scan Off` momentarily if scan is enabled.

Editing the Scan List



NOTICE:

If the scan list entry happens to be the currently selected group, the radio listens for activity on this group regardless of whether the list entry currently shows a check mark or not. Whenever a radio is not in a call, the radio listens for activity on its Selected Group, Multi-group, the Site All Call, and its Default Emergency Revert Group (if configured for one). This operation cannot be disabled. If Scan is enabled the radio will also listen for activity on enabled Zone Scan List members.

Your scan list determines which groups can be scanned. The list is created when your radio is programmed. If your

radio has been programmed to allow you to edit the scan list, you can:



- Enable/disable scan for individual groups on the list.
- Add and Remove the scan members from the Add Member menu. Refer to [Add or Delete a Group via the Add Members Menu on page 250](#).





NOTICE:

A Scan List member must be a regular Group Contact (not Multi-group or Site All Call/Network Wide All Call) that is currently assigned to a Channel Selector position in a Connect Plus Zone with the same Network ID as the currently selected Zone. The Talkgroup alias must not match any Talkgroup that has been included in the current Zone Scan List.

- 1 Press  to access the menu.

- 2 Press  or  to `View/Edit List` and press  to select.

- 3 Press  or  to the desired Group name.

If a check mark precedes the Group name, then scan is currently enabled for this Group.

If there is no check mark preceding the Group name, then scan is currently disabled for this Group.

- 4  to select the desired Group.

The display shows `Enable` if scan is currently disabled for the Group.

The display shows `Disable` if scan is currently enabled for the Group.

- 5 Select the displayed option (`Enable` or `Disable`) and press  to select.

Depending on which option was selected, the radio momentarily displays `Scan Enabled` or `Scan Disabled` as confirmation.



The radio displays the Zone scan list again. If scan was enabled for the Group, the check mark displays before the Group name. If scan was disabled for the Group, the check mark is removed before the Group name.



Add or Delete a Group via the Add Members Menu

The Connect Plus radio does not allow a duplicate group number or a duplicate group alias to be placed on a zone scan list (or to be shown as a "scan candidate"). Thus, the list of "scan candidates" described in [step 6](#) and [step 7](#) sometimes changes after adding or deleting a group from the zone scan list.

If your radio has been programmed to allow you to edit the scan list, you can use the Add Members menu to add a group to the scan list of the currently selected zone, or to delete a group from the scan list of the currently selected zone.

- 1 Press  to access the menu.
-



- 2 Press  or  to Scan option and press  to select.
-

- 3 Press  or  to <Add Members> and press  to select.

The display shows Add Members from Zone n (n = the Connect Plus zone number of the first Connect Plus zone in your radio with the same Network ID as your currently selected zone).

- 4 Do one of the following.

- If the group you want to add to the scan list is assigned to a channel selector position in that zone, go to [step 6](#).
 - If the group you want to add to the scan list is assigned to a channel selector position in a different Connect Plus zone, go to [step 5](#).
-

- 5 Press  or  to scroll a list of Connect Plus zones that have the same Network ID as the currently selected zone.
-

- 6 After locating the Connect Plus zone where the desired group is assigned to a channel selector position, press  to select.

Your radio displays the first entry in a list of groups assigned to a channel position in that zone. The groups on the list are called "scan candidates", because they can be added to the scan list of your currently selected zone (or they are already on the zone scan list).

If the zone does not have any groups that can be added to the scan list, the radio displays No Candidates.

- 7 Press  or  to scroll through the list of candidate groups.

If a plus sign (+) is displayed immediately before the group alias, this indicates the group is currently on the scan list for the selected zone.

If the plus sign (+) is not displayed immediately before the alias, the group is not currently on the scan list, but can be added.

- 8 Press  when the desired group alias is displayed.

If this group is not currently on the scan list for the currently selected zone, the **Add** (Group Alias) message is displayed.

If this group is already on the scan list for the currently selected zone, the **Delete** (Group Alias) message is displayed.

- 9 Press  to accept the displayed message (**Add** or **Delete**).

If deleting a group from the list, you will know the operation is successful because the plus sign (+) will no longer display immediately before the alias.

If adding a group to the list, you will know the operation is successful because the plus sign (+) will display before the alias.

If you are attempting to add a group, and the list is already full, the radio displays **List Full**. If this should occur, it will be necessary to delete a group from the scan list prior to adding a new one.

- 10 When finished, press  as many times as necessary to return to the desired menu.

Understanding Scan Operation



NOTICE:

If the Radio joins a call for a Zone Scan List member from a different Zone and Call Hang Timer expires before you are able to respond, in order to respond, you must navigate to the Zone and Channel of the Scan List Member and start a new call.

There are some circumstances in which you can miss calls for groups that are in your scan list. When you miss a call for one of the following reasons, this does not indicate a problem with your radio. This is a normal scan operation for Connect Plus.

- Scan feature is not turned on (check for the scan icon on the display).
- Scan list member has been disabled via the menu (see [Editing the Scan List on page 249](#)).
- You are participating in a call already.
- No member of the scanned group is registered at your site (Multisite systems only).

Scan Talkback

If your radio scans into a call from the selectable group scan list, and if the **PTT** button is pressed during the scanned call, the operation of the radio depends on whether Scan Talkback was enabled or disabled during radio programming. Check with your dealer or system administrator for more information.

Scan Talkback Disabled

The radio leaves the scanned call and attempts to transmit on the contact for the currently selected channel position. After the Call Hang Time on the currently selected contact expires, the radio returns to the home channel and starts the Scan Hang Time Timer. The radio resumes group scan after its Scan Hang Time Timer expires.

Scan Talkback Enabled

If the **PTT** button is pressed during the Group Hang Time of the scanned call, the radio attempts to transmit to the scanned group.



NOTICE:

If you scan into a call for a group that is not assigned to a channel position in the currently selected zone and you miss the Hang Time of the call, switch to the proper zone and then select the channel position of the group to talk back to that group.

Editing Priority for a Talkgroup

The Priority Monitor feature allows the radio to automatically receive transmission from the talkgroup with higher priority when it is in another call. A tone sounds when the radio switches to the call with higher priority. There are two levels of priority for the talkgroups: P1 and P2. P1 has higher priority than P2.





NOTICE:



If Default Emergency Revert Group ID is configured in MOTOTRBO Connect Plus Option Board CPS, there are three levels of priority for talkgroups: P0, P1, and P2. P0 is the permanent Emergency Revert Group ID and the highest priority. Check with your dealer or system administrator for more information.



1



Press  to access the menu.

2 Press  or  to Scan and press  to select.

3 Press  or  to View/Edit List and press  to select.

4 Press  or  to the required talkgroup and press  to select.

5 Press  or  to Edit Priority and press  to select.

6 Press  or  to the required priority level and press  to select.

The display shows positive mini notice before returning to the previous screen. The priority icon appears on the left of the talkgroup.

Contacts Settings



NOTICE:

You can add, or edit subscriber IDs for Connect Plus Contacts. Deleting subscriber IDs can only be performed by your dealer.

If the Privacy feature is enabled on a channel, you can make a privacy-enabled voice call on that channel. Only target radios with the same Privacy Key, or the same Key Value and Key ID as your radio are able to unscramble the transmission.

Access to Contact Lists depends on the zone configuration:

- If only one zone is configured in the radio, the Contact List directly displays the list from the current selected zone.
- If multiple zones are configured in the radio, the Zone Contact Folder displays all zones with identical network IDs as the current selected zone. The user can access the contacts in these zones.

Contacts provide “address-book” capabilities on your radio. Each entry corresponds to an alias or ID that you use to initiate a call.



Each zone provides a Contact List with up to 100 contacts. The following contact types are available:

- Private Call
- Group Call
- Multigroup Call
- Site All Call Voice
- Site All Call Text
- Dispatch Call

The Dispatch Call contact type is used to send a text message to a dispatcher PC through a third-party Text Message Server.

Making a Private Call from Contacts

- 1 Press  to access the menu.

- 2 Press  or  to `Contacts` and press  to select.
The entries are alphabetically sorted.

- 3 Hold the microphone 1 to 2 inches (2.5 to 5.0 cm) from your mouth.

- 4 Press the **PTT** button to make the call.
The LED lights up solid green.

- 5 Wait for the Talk Permit Tone to finish (if enabled), and speak clearly into the microphone.

- 6 Release the **PTT** button to listen.

When the target radio responds, the LED blinks green and the display shows the transmitting user's ID.

If there is no voice activity for a predetermined period of time, the call ends.



You hear a short tone. The display shows `Call Ended`.



Making a Call Alias Search

You can also use alias or alphanumeric search to retrieve the required subscriber alias.

This feature is only applicable while in Contacts.

- 1 Press  to access the menu.

- 2 Press  or  to `Contacts` and press  to select.
The entries are alphabetically sorted.

- 3 Key in the first character of the required alias, and then press the  or  button to locate the required alias.

- 4 Hold the microphone 1 to 2 inches (2.5 to 5.0 cm) from your mouth.

- 5 Press the **PTT** button to make the call.
The LED lights up solid green. The display shows the destination alias.

- 6 Wait for the Talk Permit Tone to finish (if enabled), and speak clearly into the microphone.

- 7 Release the **PTT** button to listen.



When the target radio responds, the LED blinks green.



If there is no voice activity for a predetermined period of time, the call ends.

The display shows `Call Ended`.

Adding a New Contact



- 1 Press  to access the menu.

- 2 Press  or  to `Contacts` and press  to select.

- 3 Press  or  to `New Contact` and press  to select.

- 4 Use the keypad to enter the contact number and press  to confirm.

- 5 Use the keypad to enter the contact name and press  to confirm.

- 6 If adding a Radio Contact, press  or  to the required ringer type and press  to select.





The radio sounds a positive indicator tone and the display shows `Contact Saved`.



Call Indicator Settings



This feature allows the radio users to configure call or text message ringing tones.



Activating and Deactivating Call Ringers for Call Alert



You can select, or turn on or off ringing tones for a received Call Alert.

- 1 Press  to access the menu.
-
- 2 Press  or  to `Utilities` and press  to select.
-



- 3 Press  or  to `Radio Settings` and press  to select.
-

- 4 Press  or  to `Tones/Alert` and press  to select.
-

- 5 Press  or  to `Call Ringers` and press  to select.
-

- 6 Press  or  to `Call Alert` and press  to select.

The current tone is indicated by a .



- 7 Press  or  to the required tone and press  to select.



 appears beside selected tone.



Activating and Deactivating Call Ringers for Private Calls



You can turn on or off the ringing tones for a received Private Call.



- 1 Press  to access the menu.

- 2 Press  or  to Utilities and press  to select.

- 3 Press  or  to Radio Settings and press  to select.

- 4 Press  or  to Tones/Alerts and press  to select.

- 5 Press  or  to Call Ringers and press  to select.

- 6 Press  or  to Private Call and press  to select.

- 7 Press  to enable/disable the Private Call ringing tones.



The display shows  beside Enabled, if Private Call ringing tones are enabled.



The  is not displayed when Private Call ringing tones are disabled.



Activating and Deactivating Call Ringers for Text Message



You can turn on or off the ringing tones for a received Text Message.



- 1 Press  to access the menu.

- 2 Press  or  to Utilities and press  to select.



3 Press  or  to Radio Settings and press  to select.

4 Press  or  to Tones/Alerts and press  to select.

5 Press  or  to Call Ringers and press  to select.

6 Press  or  to Text Message and press  to select.

The current tone is indicated by a .

7 Press  or  to the required tone and press  to select.

 appears beside selected tone.

Selecting a Ring Alert Type



NOTICE:

The programmed **Ring Alert Type** button is assigned by your dealer or system administrator. Check with your dealer or system administrator to determine how your radio has been programmed.

You can program the radio calls to one predetermined vibrate call. If All Tones status is disabled, the radio displays the All Tone Mute icon. If All Tones status is enabled, the related ring alert type is displayed.

The radio vibrates once if it is a momentary ring style. The radio vibrates repetitively if it is a repetitive ring style. When set to Ring and Vibrate, the radio sounds a specific ring tone if there is any incoming radio transaction (for example, Call Alert or Message). It sounds like a positive indicator tone or missed call.

Escalating Alarm Tone Volume

You can program your radio to continually alert you when a radio call remains unanswered. This is done by

automatically increasing the alarm tone volume over time. This feature is known as Escalert.

Call Log

Your radio keeps track of all recent outgoing, answered, and missed Private Calls. Use the call log feature to view and manage recent calls.



You can perform the following tasks in each of your call lists:



- Delete
- View Details

Viewing Recent Calls

The lists are Missed, Answered, and Outgoing.

- 1 Press  to access the menu.

- 2 Press  or  to Call Log and press  to select.

- 3 Press  or  to preferred list and press  to select.



The display shows the most recent entry at the top of the list.



- 4 Press  or  to view the list.

Press the **PTT** button to start a Private Call with the current selected alias or ID.



Deleting a Call from a Call List



- 1 Press  to access the menu.

- 2 Press  or  to Call Log and press  to select.





- 3 Press  or  to the required list and press  to select.

When you select a call list and it contains no entries, the display shows *List Empty*, and sounds a low tone if Keypad Tones are turned on .

4 Press  or  to the required alias or ID and press  to select.



5 Press  or  to *Delete* and press  to select.



6 Do one of the following:



- Press  to select *Yes* to delete the entry. The display shows *Entry Deleted*.
- Press  or  to *No*, and press the  button to return to the previous screen.



Viewing Details from a Call List

1 Press  to access the menu.

2 Press  or  to *Call Log* and press  to select.

3 Press  or  to the required list and press  to select.

4 Press  or  to the required alias or ID and press  to select.

5 Press  or  to *View Details* and press  to select.
Display shows details of call list.

Call Alert Operation

Call Alert paging enables you to alert a specific radio user to call you back when they are able to do so.

This feature is accessible through the menu by using *Contacts*, manual dial or a programmed **One Touch Access** button.

Responding to Call Alerts

Follow the procedure to respond to Call Alerts on your radio.

When you receive a Call Alert:

- A repetitive tone sounds.
- The yellow LED blinks.
- The display shows the notification list listing a Call Alert with the alias or ID of the calling radio.



Depending on the configuration by your dealer or system administrator, you can respond to a Call Alert by doing one of the following:







- Press the **PTT** button and respond with a Private Call directly to the caller.
- Press the **PTT** button to continue normal talkgroup communication. The Call Alert is moved to the Missed Call option at the Call Log menu. You can respond to the caller from the Missed Called log.



See [Notification List on page 181](#) and [Call Log Features on page 122](#) for more information.

Making a Call Alert from the Contact List

- 1 Press  to access the menu.

- 2 Press  or  to `Contacts` and press  to select.

- 3 Use one of the steps described next to select the required subscriber alias or ID:
 - select the subscriber alias directly
 - Press  or  to the required subscriber alias and press  to select.
 - use the `Manual Dial` menu
 - Press  or  to `Manual Dial` and press  to select.
 - The `Manual Dial` text entry screen shall be displayed. Enter the Subscriber ID and press  .

- 4 Press  or  to Call Alert and press  to select.

The display shows Call Alert: <Subscriber Alias or ID>Call Alert and the subscriber alias or ID, indicating that the Call Alert has been sent.

The LED lights up solid green when your radio is sending the Call Alert.

If the Call Alert acknowledgement is received, the display shows Call Alert Successful.

If the Call Alert acknowledgement is not received, the display shows Call Alert Failed.

Making a Call Alert with the One Touch Access Button

Press the programmed **One Touch Access** button to make a Call Alert to the predefined alias.

The display shows Call Alert and the subscriber alias or ID, indicating that the Call Alert has been sent.

The LED lights up solid green when your radio is sending the Call Alert.

If the Call Alert acknowledgement is received, the display shows Call Alert Successful.

If the Call Alert acknowledgement is not received, the display shows Call Alert Failed.

Mute Mode

Mute Mode provides an option to the user to silence all audio indicators of the radio.

Once Mute Mode feature is initiated, all audio indicators are muted except higher priority features such as Emergency operations.

When Mute Mode is exited, the radio resumes playing ongoing tones and audio transmissions.



NOTICE:

This is a purchasable feature. Check with your dealer or system administrator for more information.

Turning On Mute Mode

Follow the procedure to turn on Mute Mode.

Access this feature by using the programmed **Mute Mode** button.

The following occurs when Mute mode is enabled:



- Positive Indicator Tone sounds.
- Display shows `Mute Mode On`.
- The red LED light starts blinking and remains blinking until Mute Mode is exited.
- Display shows **Mute Mode** icon on home screen.
- Radio is muted.
- Mute Mode Timer begins counting down the duration that is configured.



Setting Mute Mode Timer



Mute Mode feature can be enabled for a pre-configured amount of time by setting the Mute Mode Timer. The timer duration is configured in the radio menu and can range between 0.5–6 hours. Mute Mode is exited once the timer expires.



If the timer is left at 0, the radio remains in Mute mode for an indefinite period until the programmed **Mute Mode** button is pressed.

- 1 Press  to access the menu.

- 2 Press  or  to Utilities. Press  to select.

- 3 Press  or  to Radio Settings. Press  to select.

- 4 Press  or  to Mute Timer. Press  to select.

- 5 Press  or  to edit the numeric value of each digit, and press .

Exiting Mute Mode

This feature can be exited automatically once the Mute Mode Timer expires.

Do one of the following to exit Mute mode manually:

- Press the programmed **Mute Mode** button.
- Press the **PTT** button on any entry.

The following occurs when Mute mode is disabled:

- Negative Indicator Tone sounds.
- Display shows `Mute Mode Off`.
- The blinking red LED turns off.
- **Mute Mode** icon disappears from home screen.
- Your radio unmutes and speaker state is restored.
- If the timer has not expired, Mute mode timer is stopped.



NOTICE:

Mute Mode is also exited if the user transmits voice or switches to an unprogrammed channel.

Emergency Operation



NOTICE:

If your radio is programmed for Silent or Silent with Voice emergency initiation, in most cases it automatically exits silent operation after the Emergency Call or Emergency Alert is finished. The exception to this rule is when Emergency Alert is the configured Emergency Mode and Silent is the configured Emergency Type. If your radio is programmed in this manner, the silent operation continues until you cancel silent operation by pressing **PTT** or the button configured for Emergency Off.

Emergency voice calls and Emergency Alerts are not supported when operating in Connect Plus Auto Fallback mode. For more information see the [Auto Fallback on page 242](#).

An Emergency Alert is used to indicate a critical situation. You can initiate an Emergency at any time on any screen display, even when there is activity on the current channel. Pressing the **Emergency** button initiates the programmed Emergency mode. The programmed Emergency mode may also be initiated by triggering the optional Man Down feature. The Emergency feature may be disabled in your radio.

Your dealer can set the duration of a button press for the programmed **Emergency** button, except for long press, which is similar with all other buttons:

Short press

Between 0.05 seconds and 0.75 seconds.

Long press

Between 1.00 second and 3.75 seconds.

The **Emergency** button is assigned with the Emergency On/Off feature. Check with your dealer for the assigned operation of the **Emergency** button.

- If the short press for the **Emergency** button is assigned to turn on the Emergency mode, then the long press for the **Emergency** button is assigned to exit the Emergency mode.
- If the long press for the **Emergency** button is assigned to turn on the Emergency mode, then the short press for the **Emergency** button is assigned to exit the Emergency mode.

When your radio is selected to a Connect Plus zone, it supports three Emergency modes:

Emergency Call

You must press the **PTT** button to talk on the assigned emergency time slot.

Emergency Call with Voice to Follow

For the first transmission on the assigned emergency time slot, the microphone is automatically unmuted and you may talk without pressing the **PTT** button. The microphone stays “hot” in this fashion for a time period programmed into the radio. For subsequent transmissions in the same Emergency call, you must press the **PTT** button.

Emergency Alert

An Emergency Alert is not a voice call. It is an emergency notification that is sent to radios that are configured to receive these alerts. The radio sends an emergency alert by using the control channel of the currently registered site. The Emergency Alert is received by radios in the Connect Plus network that are programmed to receive them (no matter which network site they are registered to).

Only one of the Emergency Modes can be assigned to the Emergency button per zone. In addition, each Emergency mode has the following types:

Regular

Radio initiates an Emergency and shows audio and/or visual indicators.

Silent

Radio initiates an Emergency without any audio or visual indicators. The radio suppresses all audio or visual indications of the Emergency until you press the **PTT** button to start a voice transmission.

Silent with Voice

The same as Silent operation, except that the radio also unmutes for some voice transmissions.

Receiving an Incoming Emergency

Your radio may be programmed to sound an alert tone and also display information about the incoming Emergency. If so programmed, upon receiving the incoming Emergency, the display shows the Emergency Details screen with the emergency icon, the Alias or ID of the radio that requested the Emergency, the Group Contact being used for the Emergency, and one additional line of information. The additional information is the name of the zone that contains the Group Contact.

At the present time, the radio displays only the most recently decoded Emergency. If a new Emergency is received before the prior Emergency is cleared, the details for the new Emergency replace the details of the previous Emergency.

Depending on how your radio has been programmed, the Emergency Details screen (or Alarm List screen) will stay on your radio display even after the Emergency ends. You can save the emergency details to the Alarm List, or you can delete the emergency details as described in the following sections.

Saving the Emergency Details to the Alarm List

Saving the emergency details to the Alarm List allows you to view the details again at a later time by selecting Alarm List from the Main Menu.

- 1 While the Emergency Details (or Alarm List) screen is displayed, press  .
The **Exit Alarm List** screen displays.



-
- 2 Perform one of the following actions:
 - Select **Yes** and press  to save the emergency details to the Alarm List, and to exit the Emergency Details (or Alarm List) screen.

- Select **No** and press  to return to the Emergency Details (or Alarm List) screen.
-

Deleting the Emergency Details

- 1 While the Emergency Details screen is displayed, press  .

The **Delete** screen displays.

- 2 Perform one of the following actions:
 - Select **Yes** and press  to delete the emergency details.
 - Select **No** and press  to return to the Emergency Details screen.
-

Responding to an Emergency Call



NOTICE:

If you do not respond to the Emergency Call within the time allotted for the Emergency Call Hang Time, the Emergency call will end. If you want to speak to the group after the Emergency Call Hang Time expires, you must first select the channel position assigned to the group (if not already selected). Then, press **PTT** to start a non-Emergency Call to the group.

- 1 When receiving an Emergency Call, press any button to stop all Emergency Call received indications.

 - 2 Press the **PTT** button to initiate a voice transmission on the Emergency group.

All radios that are monitoring this group hear your transmission.

 - 3 Wait for the Talk Permit Tone to finish (if enabled) and speak clearly into the microphone.

The LED lights up green.
-

4 Release the **PTT** button to listen.

When the emergency initiating radio responds, the LED blinks green. You see the Group Call icon, the group ID, and transmitting radio ID on your display.

Responding to an Emergency Alert



NOTICE:

The Group contact used for the Emergency Alert should not be used for voice communication. This could prevent other radios from sending and receiving Emergency Alerts on the same group.

An Emergency Alert from a radio indicates that the user is in an urgent situation. You may respond to the alert by initiating a private call to the radio who declared the emergency, initiating a group call to a designated talk group, sending the radio a Call Alert, initiating a Remote Monitor of that radio, etc. The proper response is determined by your organization and the individual situation.

Ignore Emergency Revert Call

This feature enhancement is to provide an option for the radio to ignore an active Emergency Revert Call.

To enable Ignore Emergency Revert Call, the radio must be configured at the Connect Plus Customer Programming Software (CPCPS).

When the feature is enabled, the radio does not display Emergency Call indications and does not receive any audio on the default Emergency Revert Group ID.

Check with your dealer or system administrator for more information.

Initiating an Emergency Call



NOTICE:

If your radio is set to Silent, it does not display any audio or visual indicators during Emergency mode until you press the **PTT** button to initiate a voice transmission.

If your radio is set to Silent with Voice, it does not initially display any audio or visual indicators that the radio is in Emergency mode. However, your radio unmutes for the transmissions of radios responding to your emergency. The emergency indicators only appear once you press the **PTT** button to initiate a voice transmission from your radio.

For both "Silent" and "Silent with Voice" operation, the radio automatically exits silent operation after the Emergency Call is finished.

- 1 Press the programmed **Emergency** button.
- 2 Press the **PTT** button to initiate a voice transmission on the Emergency group.

When you release the **PTT** button, the Emergency call continues for the time allotted for the Emergency Call Hang Time.

If you press the **PTT** button during this time, the Emergency call continues.

Initiating an Emergency Call with Voice to Follow

Your radio must be programmed for this type of operation.

When enabled for this operation, when you press the programmed **Emergency** button, and when your radio receives the time slot assignment, the microphone is automatically activated without pressing the **PTT** button. This activated microphone state is also known as "hot mic". The "hot mic" applies to the first voice transmission from your radio during the Emergency call. For subsequent transmissions in the same Emergency call, you must press the **PTT** button.

- 1 Press the programmed **Emergency** button.
- 2 The microphone remains active for the "hot mic" time specified in your radio codeplug programming.
During this time, the LED lights up green.

- 3 Press and hold the **PTT** button to talk longer than the programmed duration.
-

Initiating an Emergency Alert



NOTICE:

If your radio is programmed for "Silent" or "Silent with Voice", it will not provide any audio or visual indications that it is sending an Emergency Alert. If programmed for "Silent", the silent operation continues indefinitely until you press PTT or the button configured for "Emergency Off". If programmed for "Silent with Voice", the radio automatically cancels silent operation when the site controller broadcasts the Emergency Alert.

Press the orange **Emergency** button.

Upon transmitting the Emergency Alert to the site controller, the radio display shows the Emergency icon, the Group contact used for the Emergency Alert, and TX Alarm.

Once the Emergency Alert is successfully sent and is being broadcast for other radios to hear, a positive indicator tone sounds and the radio displays Alarm Sent. If the

Emergency Alert is unsuccessful, a negative indicator tone sounds and the radio displays Alarm Failed.

Exiting Emergency Mode



NOTICE:

If the Emergency call ends due to the expiration of the Emergency Hang Time, but the emergency condition is not over, press the **Emergency** button again to restart the process.

If you initiate an Emergency Alert by pressing the programmed **Emergency** button, your radio automatically exits Emergency mode after receiving a response from the Connect Plus system.

If you initiate an Emergency call by pressing the programmed **Emergency** button, your radio will be assigned a channel automatically when one becomes available. Once your radio has transmitted a message indicating the emergency, you cannot cancel your Emergency call. However, if you pressed the button by accident or the emergency no longer exists, you may wish to say this over the assigned channel. When you release the **PTT** button, the Emergency call is discontinued after the Emergency Call Hang Time expires.

If your radio was configured for Emergency with Voice to Follow, use the “hot mic” period to explain your error, then press and release the **PTT** button to discontinue the transmission. The Emergency call is discontinued after the Emergency Call Hang Time expires.

Text Messaging

Your radio is able to receive data, for example a text message, from another radio or a text message application.

There are two types of text messages, Digital Mobile Radio (DMR) Short Text Message and text message. The maximum length of a DMR Short Text Message is 23 characters. The maximum length of a text message is 280 characters, including the subject line. The subject line only appears when you receive messages from e-mail applications.



NOTICE:







The maximum character length is only applicable for models with the latest software and hardware. For radio models with older software and hardware, the maximum length of a text message is 140 characters. Check with your dealer or system administrator for more information.

Sending a Quick Text Message

Your radio supports a maximum of 10 Quick Text messages as programmed by your dealer.

While Quick Text messages are predefined, you can edit each message before sending it.

If you are sending the message, perform the following to select a recipient:

- Press  or  to the required alias and press  to select.
- Press  or  to Manual Dial, and press  to select. The first line of the display shows Number: . The second line of the display shows a blinking cursor. Key in the subscriber alias or ID and press .

The display shows `Sending Message`, confirming your message is being sent.

If the message is sent successfully, a tone sounds and the display shows `Message Sent`.

If the message cannot be sent, a low tone sounds and the display shows `Message Send Failed`.

If the text message fails to send, the radio returns you to the `Resend` option screen (see [Managing Fail-to-Send Text Messages on page 276](#)).

Sending a Quick Text Message with the One Touch Access Button

You can send Quick Text messages using the programmable button programmed by your dealer.

Press the programmed **One Touch Access** button to send a predefined Quick Text message to a predefined alias.

The display shows `Sending Message`, confirming your message is being sent.

If the message is sent, a tone sounds and the display shows `Message Sent`.

If the message cannot be sent, a low tone sounds and the display shows `Message Send Failed`.

If the text message fails to send, the radio returns you to the `Resend` option screen (see [Managing Fail-to-Send Text Messages on page 276](#)).

Accessing the Drafts Folder

The Drafts folder stores a maximum of ten (10) last saved messages. When the folder is full, the next saved text message automatically replaces the oldest text message in the folder.







NOTICE:



You can edit saved text message before sending it. Only available with a keypad microphone (see [Editing and Sending a Saved Text Message on](#)



[page 274](#). Long press  at any time to return to the Home screen.

Viewing a Saved Text Message

- 1 Access the **Text Message** feature.



Radio Controls	Steps
Programmed Text Message button	Press the programmed Text Message button.
Menu	<p>a Press  to access the menu.</p> <p>b Press  or  to Messages and press  to select.</p>

2 Press  or  to Drafts and press  to select.

3 Press  or  to the required message and press  to select.





Editing and Sending a Saved Text Message

1 Press  again while viewing the message.

2 Press  or  to Edit and press  to select.

A blinking cursor appears.







3 Use the keypad to type your message.

Press  to move one space to the left. Press  or the  key to move one space to the right. Press the  key to delete any unwanted characters.

Long press  to change text entry method.

4 Press  once message is composed.

5 Select the message recipient by:

- Press  or  to the required alias and press  to select.
- Press  or  to Manual Dial, and press  to select. The first line of the display shows Number:1. The second line of the display shows a blinking cursor. Key in the subscriber alias or ID and press .

The display shows Sending Message, confirming your message is being sent.





If the message is sent successfully, a tone sounds and the display shows Message Sent.



If the message cannot be sent, a low tone sounds and the display shows Message Send Failed.



If the text message cannot be sent, it is moved to the Sent Items folder and marked with a Send Failed icon.



Deleting a Saved Text Message from Drafts

- 1 Access the **Text Message** feature.

Radio Controls	Steps
Programmed Text Message button	Press the programmed Text Message button.
Menu	<p>a Press  to access the menu.</p> <p>b Press  or  to Messages and press  to select.</p>

- 2 Press  or  to Drafts and press  to select.

3 Press  or  to the required message and press  to select.

4 Press  or  to Delete and press  to delete the text message.

Managing Fail-to-Send Text Messages

You can select one of the following options while at the Resend option screen:

- Resend
- Forward
- Edit

Resending a Text Message



Press  to resend the same message to the same subscriber/group alias or ID.



If the message is sent successfully, a tone sounds and the display shows the positive mini notice.

If the message cannot be sent, the display shows the negative mini notice.

Forwarding a Text Message

Select Forward to send the message to another subscriber/group alias or ID.

1 Press  or  to Forward and press  to select.

2 To select the message recipient, press  or  to the required alias or ID and press  to select.

The display shows `Sending Message`, confirming your message is being sent.

If the message is sent successfully, a tone sounds and the display shows `Message Sent`.

If the message cannot be sent, a low tone sounds and the display shows `Message Send Failed`.

Managing Sent Text Messages

Once a message is sent to another radio, it is saved in Sent Items. The most recent sent text message is always added to the top of the Sent Items list.

The Sent Items folder is capable of storing a maximum of 30 last sent messages. When the folder is full, the next sent text message automatically replaces the oldest text message in the folder.







NOTICE:



Long press  at any time to return to the Home screen.



Viewing a Sent Text Message

- 1 Access the **Text Message** feature.

Radio Controls	Steps
Programmed Text	Press the programmed Text Message button.

Radio Controls	Steps
Message button	
Menu	<p>a Press  to access the menu.</p> <p>b Press  or  to Messages and press  to select.</p>

- 2 Press  or  to Sent Items and press  to select.

- 3 Press  or  to the required message and press  to select.



The icon at the top right corner of the screen indicates the status of the message (see [Sent Item Icons on page 223](#)).

Sending a Sent Text Message

You can select one of the following options while viewing a sent text message:

- Resend
- Forward
- Edit
- Delete

1 Press  again while viewing the message.

2  or  to one of the following options and press  to select.

Option	Steps
Forward	Select Forward to send the selected text message to another subscriber/group alias or ID (see Forwarding a Text Message on page 276).
Delete	Select Delete to delete the text message.

Option	Steps
Resend	<p>Select Resend to resend the selected text message to the same subscriber/group alias or ID.</p> <p>The display shows Sending Message, confirming that the same message is being sent to the same target radio.</p> <p>If the message is sent successfully, a tone sounds and the display shows Message Sent.</p> <p>If the message cannot be sent, a low tone sounds and the display shows Message Send Failed.</p> <p>If the message fails to send, the radio returns you to the Resend option screen. Press  to resend the message to the same subscriber/group alias or ID.</p>

If you exit the message sending screen while the message is being sent, the radio updates the status

of the message in the Sent Items folder without any audio or visual indication.





If the radio changes mode or powers down before the status of the message in Sent Items is updated, the radio cannot complete any In-Progress messages and automatically marks it with a **Send Failed** icon.



The radio supports a maximum of five In-Progress messages at one time. During this period, the radio cannot send any new message and automatically marks it with a **Send Failed** icon.

Deleting All Sent Text Messages from Sent Items



- 1 Access the **Text Message** feature.



Radio Controls	Steps
Programmed Text Message button	Press the programmed Text Message button.



Radio Controls	Steps
Menu	<ol style="list-style-type: none"> a Press  to access the menu. b Press  or  to Messages and press  to select.

- 2 Press  or  to Sent Items and press  to select.

When you select Sent Items and it contains no text messages, the display shows List Empty, and sounds a low tone if Keypad Tones are turned on.

- 3 Press  or  to Delete All and press  to select.

- 4 Choose one of the following.
 - Press  or  to Yes and press  to select. The display shows positive mini notice.

- Press  or  to No and press  to return to the previous screen.
-



Receiving a Text Message

When your radio receives a message, the display shows the Notification List with the alias or ID of the sender and the Message icon.

You can select one of the following options when receiving a text message:



- Read
- Read Later
- Delete

Reading a Text Message

- 1 Press  or  to Read? and press  to select.

Selected message in the Inbox opens.

- 2 Do one of the following:

- Press  to return to the Inbox.
 - Press  a second time to reply, forward, or delete the text message.
-

Managing Received Text Messages

Use the Inbox to manage your text messages. The Inbox is capable of storing a maximum of 30 messages.

Text messages in the Inbox are sorted according to the most recently received.

Your radio supports the following options for text messages:

- Reply (via Quick Text)
- Forward
- Delete
- Delete All







NOTICE:



If the channel type is not a match, you can only forward, delete, or delete all Received messages.



Long press  at any time to return to the Home screen.



Viewing a Text Message from the Inbox

- 1 Press  to access the menu.

- 2 Press  or  to **Messages** and press  to select.





- 3 Press  or  to **Inbox** and press  to select.



- 4 Press  or  to view the messages.



- 5 Do one of the following:
 - Press  to select the current message, and press  again to reply, forward, or delete that message.
 - Long press  to return to the Home screen.

Replying to a Text Message from the Inbox

- 1 Access the **Text Message** feature.

Radio Controls	Steps
Programmed Text Message button	Press the programmed Text Message button.
Menu	<ol style="list-style-type: none"> a Press  to access the menu. b Press  or  to Messages and press  to select.

- 2 Press  or  to **Inbox** and press  to select.

3 Press  or  to the required message and press  to select.

4 Press  once more to access the sub-menu.

5 Use your keypad to write/edit your message.

6 Press  once message is composed.

The display shows `Sending Message`, confirming your message is being sent.





If the message is sent successfully, a tone sounds and the display shows `Message Sent`.



If the message cannot be sent, a low tone sounds and the display shows `Message Send Failed`.



If the message cannot be sent, the radio returns you to the `Resend` option screen (see [Managing Fail-to-Send Text Messages on page 276](#)).

Deleting a Text Message from the Inbox



1 Access the **Text Message** feature.



Radio Controls	Steps
Programmed Text Message button	Press the programmed Text Message button.
Menu	<p>a Press  to access the menu.</p> <p>b Press  or  to <code>Messages</code> and press  to select.</p>

2 Press  or  to `Inbox` and press  to select.

3 Press  or  to the required message and press  to select.

4 Press  once more to access the sub-menu.

5 Press  or  to Delete and press  to select.



6 Press  or  to Yes and press  to select.



The display shows Message Deleted, and the screen returns to the Inbox.

Deleting All Text Messages from the Inbox



1 Access the **Text Message** feature.



Radio Controls	Steps
Programmed Text Message button	Press the programmed Text Message button.
Menu	a Press  to access the menu.

Radio Controls	Steps
	b Press  or  to Messages and press  to select.

2 Press  or  to Inbox and press  to select.

When you select Inbox and it contains no text messages, the display shows List Empty, and sounds a low tone if Keypad Tones are turned on (see [Turning Keypad Tones On or Off on page 195](#)).

3 Press  or  to Delete All and press  to select.

4 Press  or  to Yes and press  to select.
The display shows Inbox Cleared.

Privacy

If enabled, this feature helps to prevent eavesdropping by unauthorized users on a channel by the use of a software-based scrambling solution. The signaling and user identification portions of a transmission are not scrambled.

Your radio must have privacy enabled on the current channel selector position to send a privacy-enabled transmission, although this is not a necessary requirement for receiving a transmission. While on a privacy-enabled channel selector position, the radio is still able to receive clear (unscrambled) transmissions.

Your radio supports Enhanced Privacy.

To unscramble a privacy-enabled call transmission, your radio must be programmed to have the same Key Value and Key ID (for Enhanced Privacy) as the transmitting radio.

If your radio receives a scrambled call that is of a different Key Value and Key ID, you hear nothing at all (Enhanced Privacy).

If the radio has a privacy type assigned, the Home screen shows the Secure or Unsecure icon, except when the radio is sending or receiving an Emergency call or alarm.

The LED lights up solid green while the radio is transmitting and blinks green rapidly when the radio is receiving an ongoing privacy-enabled transmission.

You can access this feature by performing one of the following actions:



- Press the programmed **Privacy** button to toggle privacy on or off.
- Using the Radio Menu as described by the steps described next.







NOTICE:

Some radio models may not offer this Privacy feature. Check with your dealer or system administrator for more information.

- 1 Press  to access the menu.

- 2 Press  or  to Utilities and press  to select.

- 3 Press  or  to Radio Settings or  or  to Connect Plus and press  to select.

- 4 Press  or  to Enhanced Privacy.

If the display shows Turn On, press  to enable Privacy. The radio displays a message confirming your selection.

If the display shows Turn Off, press  to disable Privacy. The radio displays a message confirming your selection.

If the radio has a privacy type assigned, the secure or unsecure icon appears on the status bar, except when the radio is sending or receiving an Emergency Alert.

scanned calls, Site All Call, Emergency Call, and Private Call. Only receiving radios with the same Key Value and Key ID as your radio will be able to unscramble the transmission.

Security

You can enable or disable any radio in the system. For example, you might want to disable a stolen radio, to prevent the thief from using it, and enable that radio, when it is recovered.



NOTICE:







Performing Radio Disable and Enable is limited to radios with these functions enabled. Check with your dealer or system administrator for more information.









Radio Disable





- 1 Access this feature by performing one of the following actions:

Making a Privacy-Enabled (Scrambled) Call

Toggle privacy on using the programmed privacy button or by using the menu. Your radio must have the Privacy feature enabled for the currently selected channel position to send a privacy-enabled transmission. When privacy is enabled for the currently selected channel position, all voice transmissions made by your radio will be scrambled. This includes Group Call, Multigroup Call, talk-back during

Radio Controls	Steps
Radio Disable button	<p>a Press the programmed Radio Disable button.</p> <p>b Press  or  to the required alias or ID and press  to select.</p>
Radio menu	<p>a Press  to access the menu.</p> <p>b Press  or  to Con- tacts and press  to select. The entries are alphabetically sorted.</p> <p>c Use one of the steps described next to select the required subscriber alias or ID:</p> <ul style="list-style-type: none"> • Select the required alias or ID directly.

Radio Controls	Steps
	<ul style="list-style-type: none"> • Press  or  to the required alias or ID and press  to select. • Use the Manual Dial menu. <ul style="list-style-type: none"> • Press  or  to Manual Dial and press  to select. • Press  or  to Radio Number and press  to select. • The first line of the display shows Radio Number:!. The second line of the display shows a blinking cursor. Use the keypad to en-

Radio Controls	Steps
	<p>ter the subscriber alias or ID and press  .</p> <p>d Press  or  to Radio Disable and press  to select.</p>

The display shows Radio Disable: <Target Alias or ID> and the LED blinks green.







2 Wait for acknowledgement.







If successful, a positive indicator tone sounds and the display shows Radio Disable Successful.







If not successful, a negative indicator tone sounds and the display shows Radio Disable Failed.

Radio Enable

- 1 Access this feature by performing one of the following actions:

Radio Controls	Steps
<p>Radio Enable button</p>	<p>a Press the programmed Radio Enable button.</p> <p>b Press  or  to the required alias or ID and press  to select.</p>
<p>Radio menu</p>	<p>a Press  to access the menu.</p> <p>b Press  or  to Contacts and press  to select. The entries are alphabetically sorted.</p>

Radio Controls	Steps
	<p>c Use one of the steps described next to select the required subscriber alias or ID</p> <ul style="list-style-type: none"> • Select the required alias or ID directly. <ul style="list-style-type: none"> • Press  or  to the required alias or ID and press  to select. • Use the Manual Dial menu. <ul style="list-style-type: none"> • Press  or  to Manual Dial and press  to select.

Radio Controls	Steps
	<ul style="list-style-type: none"> • Press  or  to Radio Number and press  to select. • The first line of the display shows Radio Number!. The second line of the display shows a blinking cursor. Use the keypad to enter the subscriber alias or ID and press . <p>d Press  or  to Radio Enable and press  to select.</p>

The display shows Radio Enable: <Subscriber Alias or ID> and the LED lights up solid green.

2 Wait for acknowledgement.

If successful, a positive indicator tone sounds and the display shows `Radio Enable Successful`.

If not successful, a negative indicator tone sounds and the display shows `Radio Enable Failed`.

Bluetooth Operation



NOTICE:

If disabled via the CPS, all Bluetooth-related features are disabled and the Bluetooth device database is erased.

This feature allows you to use your radio with a Bluetooth-enabled device (accessory) via a wireless Bluetooth connection. Your radio supports both Motorola Solutions and Commercially available Off-The-Shelf (COTS) Bluetooth-enabled devices.

Bluetooth operates within a range of 10 meters (32 feet) line of sight. This is an unobstructed path between your radio and your Bluetooth-enabled device.



It is not recommended that you leave your radio behind and expect your Bluetooth-enabled device to work with a high degree of reliability when they are separated.

At the fringe areas of reception, both voice and tone quality will start to sound "garbled" or "broken". To correct this problem, simply position your radio and Bluetooth-enabled device closer to each other (within the 10-meter/32 feet defined range) to re-establish clear audio reception. Your radio's Bluetooth function has a maximum power of 2.5 mW (4 dBm) at the 10-meter/32 feet range.

Your radio can support up to 4 simultaneous Bluetooth connections with Bluetooth-enabled devices of unique types. For example, a headset, and a PTT-Only Device (POD). Multiple connections with Bluetooth-enabled devices of the same type are not supported.

Refer to your respective Bluetooth-enabled device's user manual for more details on your Bluetooth-enabled device's full capabilities.









Turning Bluetooth On and Off

- 1 Press  to access the menu.
-
- 2 Press  or  to Bluetooth and press  to select.
-

- 3 Press  or  to **My Status** and press  to select.

The display shows **On** and **Off**. The current status is indicated by a .

- 4 Do one of the following:

- Press  or  to **On** and press  to select. The display shows **On** and a  appears left of the selected status.
- Press  or  to **Off** and press  to select. The display shows **Off** and a  appears left of the selected status.



Finding and Connecting to a Bluetooth Device



Do not turn off your Bluetooth-enabled device or press

 during the finding and connecting operation as this cancels the operation.









- 1 Turn on your Bluetooth-enabled device and place it in pairing mode. Refer to respective Bluetooth-enabled device user manual.



- 2 On your radio, press  to access the menu.

- 3 Press  or  to **Bluetooth** and press  to select.

- 4 Press  or  to **Devices** and press  to select.

- 5 Do one of the following:

- Press  or  to the required device and press  to select.
- Press  or  to **Find Devices** to locate available devices. Press  or  to the required device and press  to select.

- 6 Press  or  to Connect and press  to select.

Display shows Connecting to <Device>. Your Bluetooth-enabled device may require additional steps to complete the pairing. Refer to respective Bluetooth-enabled device user manual.

If successful, the radio display shows <Device>Connected. A tone sounds and  appears besides the connected device. The Bluetooth Connected icon appears on the status bar.

If unsuccessful, the radio display shows Connecting Failed.



Finding and Connecting from a Bluetooth Device (Discoverable Mode)



Do not turn off your Bluetooth or your radio during the finding and connecting operation as this may cancel the operation.

- 1 Turn Bluetooth On.

See [Turning Bluetooth On and Off on page 289](#).

- 2 Press  to access the menu.

- 3 Press  or  to Bluetooth and press  to select.

- 4 Press  or  to Find Me and press  to select.



Your radio can now be found by other Bluetooth-enabled devices for a programmed duration. This is called Discoverable Mode.



- 5 Turn on your Bluetooth-enabled device and pair it with your radio.



Refer to respective Bluetooth-enabled device user manual.



Disconnecting from a Bluetooth Device

- 1 On your radio, press  to access the menu.

2 Press  or  to Bluetooth and press  to select.

3 Press  or  to Devices and press  to select.

4 Press  or  to the required device and press  to select.

5 Press  or  to Disconnect and press  to select.

Display shows Disconnecting from <Device>. Your Bluetooth-enabled device may require additional steps to disconnect. Refer to respective Bluetooth-enabled device user manual.

The radio display shows <Device> Disconnected. A positive indicator tone sounds and  disappears beside the connected device. The Bluetooth Connected icon disappears on the status bar.

Switching Audio Route between Internal Radio Speaker and Bluetooth Device



You can toggle audio routing between internal radio speaker and external Bluetooth-enabled accessory.



Press the programmed **Bluetooth Audio Switch** button.



- A tone sounds and display shows Route Audio to Radio.
- A tone sounds and display shows Route Audio to Bluetooth.



Viewing Device Details

1 Press  to access the menu.

2 Press  or  to Bluetooth and press  to select.

3 Press  or  to Devices and press  to select.



4 Press  or  to the required device and press  to select.



5 Press  or  to View Details and press  to select.



Deleting Device Name



You can remove a disconnected device from the list of Bluetooth-enabled devices.

1 Press  to access the menu.

2 Press  or  to Bluetooth and press  to select.

3 Press  or  to Devices and press  to select.

4 Press  or  to the required device and press  to select.



5 Press  or  to Delete and press  to select.

The display shows Device Deleted.



Bluetooth Mic Gain

Allows control of the connected Bluetooth-enabled device microphone gain value.



1 Press  to access the menu.

2 Press  or  to Bluetooth and press  to select.

3 Press  or  to BT Mic Gain and press  to select.

4 Press  or  to the BT Mic Gain type and the current values.

To edit values, press  to select.

5 Press  or  to increase or to decrease values and press  to select.

Indoor Location











NOTICE:

Indoor Location feature is applicable for models with the latest software and hardware. Check with your dealer or system administrator for more information.

Indoor Location is be used to keep track of the location of radio users. When Indoor Location is activated, the radio is in a limited discoverable mode. Dedicated beacons are used to locate the radio and determine its position.

Turning Indoor Location On or Off

You can turn on or turn off Indoor Location by performing one of the following actions.

- Access this feature through the menu.
 - a. Press  to access the menu.
 - b. Press  or  to Bluetooth and press  to select.
 - c. Press  or  to Indoor Location and press  to select.
 - d. Press  to turn on Indoor Location.

The display shows Indoor Location On. You hear a positive indicator tone. One of the following scenarios occurs.

- If successful, the Indoor Location Available icon appears on the Home screen display.

- If unsuccessful, the display shows **Turning On Failed**. You hear a negative indicator tone.

e. Press  to turn off Indoor Location.

The display shows **Indoor Location Off**. You hear a positive indicator tone.

One of the following scenarios occurs.

- If successful, the Indoor Location Available icon disappears on the Home screen display.
- If unsuccessful, the display shows **Turning Off Failed**. You hear a negative indicator tone.

• Access this feature by using the programmed button.

a. Long press the programmed **Indoor Location** button to turn on Indoor Location.

The display shows **Indoor Location On**. You hear a positive indicator tone.

One of the following scenarios occurs.

- If successful, the Indoor Location Available icon appears on the Home screen display.

- If unsuccessful, the display shows **Turning On Failed**. If unsuccessful, you hear a negative indicator tone.

b. Press the programmed **Indoor Location** button to turn off Indoor Location.

The display shows **Indoor Location Off**. You hear a positive indicator tone.



One of the following scenarios occurs.



- If successful, the Indoor Location Available icon disappears on the Home screen display.
- If unsuccessful, the display shows **Turning Off Failed**. If unsuccessful, you hear a negative indicator tone.



Accessing Indoor Location Beacons Information

Follow the procedure to access Indoor Location beacons information.

- 1 Press  to access the menu.

2 Press  or  to Bluetooth and press  to select.

3 Press  or  to Indoor Location and press  to select.

4 Press  or  to Beacons and press  to select.

The display shows the beacons information.

Notification List

Your radio has a Notification List that collects all your "unread" events on the channel, such as unread text messages, missed calls, and call alerts.

The Notification icon appears on the status bar when the Notification List has one or more events.

The list supports a maximum of 40 unread events. When it is full, the next event automatically replaces the oldest event.





NOTICE:



After the events are read, they are removed from the Notification List.

Accessing the Notification List

Follow the procedure to access the notification list.

1 Press  to access the menu.

2 Press  or  to Notification and press  to select.

3 Press  or  to the required event and press  to select.

Long press  to return to the Home Screen.

Wi-Fi Operation

This feature allows you to set up and connect to a Wi-Fi network. Wi-Fi supports updates for radio firmware,

codeplug, and resources such as language packs and voice announcement.



NOTICE:

This feature is applicable to XiR M8668i/CM7668i only.

Wi-Fi® is a registered trademark of Wi-Fi Alliance®.

Your radio supports WEP/WPA/WPA2-Personal and WPA/WPA2-Enterprise Wi-Fi networks.

WEP/WPA/WPA2-Personal Wi-Fi network

Uses pre-shared key (password) based authentication.

Pre-shared key can be entered by using the menu or CPS/RM.

WPA/WPA2-Enterprise Wi-Fi network

Uses certificate-based authentication.

Your radio must be pre-configured with a certificate.



NOTICE:

Check with your dealer or system administrator to connect to WPA/WPA2-Enterprise Wi-Fi network.

The programmed **Wi-Fi On or Off** button is assigned by your dealer or system administrator. Check with your dealer or system administrator to determine how your radio has been programmed.

Voice Announcements for the programmed **Wi-Fi On or Off** button can be customized through CPS according to user requirements. Check with your dealer or system administrator for more information.







NOTICE:



You can turn on or turn off Wi-Fi remotely by using a supervisory radio (see [Turning Wi-Fi On or Off by Using a Supervisory Radio](#)). Check with your dealer or system administrator for more information.

Turning Wi-Fi On or Off

Follow the procedure to turn Wi-Fi on or off.

- 1 Press the programmed **Wi-Fi On or Off** button. Voice Announcement sounds Turning On Wi-Fi or Turning Off Wi-Fi.

- 2 Access this feature using the menu.
 - a Press  to access the menu.
 - b Press  or  to **WiFi** and press  to select.

c Press  or  to WiFi On and press  to select.

d Press  to turn on/off Wi-Fi.

If Wi-Fi is on, the display shows  beside Enabled.

If Wi-Fi is off, the  disappears from beside Enabled.

Turning Wi-Fi On or Off Remotely by Using a Designated Radio (Individual Control)

Follow the procedure to turn Wi-Fi on or off remotely in Individual Control (One to One).







NOTICE:



Only radio with specific CPS setting supports this function, check with your dealer or system administrator for more information.

1 Do one of the following:

- Long press the programmable button. Use the keypad to enter the ID and press  to select. Proceed to [step 3](#).

- Press  to access the menu.

2 Press  or  to Contacts and press  to select.

3 Press  or  to WiFi Control and press  to select.

4 Press  or  to select On or Off.

5 Press  to select.

If successful, the display shows a positive mini notice.

If unsuccessful, the display shows a negative mini notice.

Turning Wi-Fi On or Off Remotely by Using a Designated Radio (Group Control)



Follow the procedure to turn Wi-Fi on or off remotely in Group Control (One to Many).







NOTICE:

Only radio with specific CPS setting supports this function, check with your dealer or system administrator for more information.

- 1 Press  to access the menu.

- 2 Press  or  to `Contacts` and press  to select.

- 3 Press  or  to select the required subscriber alias or ID.

- 4 Press  or  to `WiFi Control` and press  to select.

- 5 Press  or  to select `On` or `Off`.

- 6 Press  to select.

If successful, the display shows `Sent Successfully`.

If unsuccessful, the display shows a negative mini notice.

Connecting to a Network Access Point

When you turn on Wi-Fi, the radio scans and connects to a network access point.









NOTICE:





You can also connect to a network access point using the menu.



The WPA-Enterprise Wi-Fi network access points are pre-configured. Check with your dealer or system administrator to determine how your radio has been programmed.

- 1 Press  to access the menu.

- 2 Press  or  to **WiFi** and press  to select.

- 3 Press  or  to **Networks** and press  to select.

- 4 Press  or  to a network access point and press  to select.
 **NOTICE:**
For WPA-Enterprise Wi-Fi, if a network access point is not preconfigured, the **Connect** option is not available.

- 5 Press  or  to **Connect** and press  to select.

- 6 For WPA-Personal Wi-Fi, enter the password and press .

- 7 For WPA-Enterprise Wi-Fi, password is configured by using RM.

If the preconfigured password is correct, your radio automatically connects to the selected network access point.

If the preconfigured password is incorrect, the display shows **Authentication Failure**, and automatically returns to the previous menu.

If the connection is successful, the radio displays a notice and the network access point is saved into the profile list.

If the connection is unsuccessful, the radio displays shows the failure notice screen momentarily and automatically returns to the previous menu.

Checking Wi-Fi Connection Status

Follow the procedure to check the Wi-Fi Connection status.

Press the programmed **Wi-Fi Status Query** button for the connection status by using Voice Announcement. Voice

Announcement sounds Wi-Fi is Off, Wi-Fi is On but No Connection, or Wi-Fi is On with Connection.

- The display shows `WiFi Off` when the Wi-Fi is turned off.
- The display shows `WiFi On, Connected` when the radio is connected to a network.
- The display shows `WiFi On, Disconnected` when the Wi-Fi is turned on but the radio is not connected to any network.

Voice Announcements for the Wi-Fi status query results can be customized through CPS according to user requirements. Check with your dealer or system administrator for more information.









NOTICE:

The programmed **Wi-Fi Status Query** button is assigned by your dealer or system administrator. Check with your dealer or system administrator to determine how your radio has been programmed.



Refreshing the Network List

Follow the procedure to refresh the network list.

- Perform the following actions to refresh the network list through the menu.
 - a. Press  to access the menu.
 - b. Press  or  to `WiFi` and press  to select.
 - c. Press  or  to `Networks` and press  to select.

When you enter the Networks menu, the radio automatically refreshes the network list.

- If you are already in the Networks menu, perform the following action to refresh the network list.

Press  or  to `Refresh` and press  to select.

The radio refreshes and displays the latest network list.

Adding a Network









NOTICE:



This task is not applicable to WPA-Enterprise Wi-Fi networks.

If a preferred network is not in the available network list, perform the following actions to add a network.

- 1 Press  to access the menu.

- 2 Press  or  to WiFi and press  to select.

- 3 Press  or  to Networks and press  to select.

- 4 Press  or  to Add Network and press  to select.

- 5 Enter the Service Set Identifier (SSID) and press .

- 6 Press  or  to Open and press  to select.



- 7 Enter the password and press .



The radio displays a positive mini notice to indicate that the network is successfully saved.



Viewing Details of Network Access Points



You can view details of network access points.

- 1 Press  to access the menu.

- 2 Press  or  to WiFi and press  to select.

- 3 Press  or  to Networks and press  to select.

- 4 Press  or  to a network access point and press  to select.

- 5 Press  or  to View Details and press  to select.



NOTICE:

WPA-Personal Wi-Fi and WPA-Enterprise Wi-Fi display different details of Network Access Points.

WPA-Personal Wi-Fi

For a connected network access point, your radio displays Service Set Identifier (SSID), Security Mode, Media Access Control (MAC) address, and Internet Protocol (IP) address.

For a non-connected network access point, your radio displays SSID and Security Mode.

WPA-Enterprise Wi-Fi

For a connected network access point, your radio displays SSID, Security Mode, Identity, Extended Authentication Protocol (EAP) Method, Phase 2 Authentication, Cert Name, MAC address, IP address, Gateway, DNS1, and DNS2.

For a non-connected network access point, your radio displays SSID, Security Mode, Identity, EAP Method, Phase 2 Authentication, and Cert Name.

Removing Network Access Points









NOTICE:



This task is not applicable to Enterprise Wi-Fi networks.



Perform the following actions to remove network access points from the profile list.

- 1 Press  to access the menu.

- 2 Press  or  to WiFi and press  to select.

- 3 Press  or  to Networks and press  to select.

4 Press  or  to the selected network access point and press  to select.

5 Press  or  to Remove and press  to select.

6 Press  or  to Yes and press  to select.

The radio displays a positive mini notice to indicate that the selected network access point is successfully removed.

Utilities



This chapter explains the operations of the utility functions available in your radio.



Turning the Radio Tones/Alerts On or Off



You can enable and disable all radio tones and alerts (except for the incoming Emergency alert tone) if needed.



Press the programmed **All Tones/Alerts** button to toggle all tones on or off, or follow the procedure described next to access this feature via the radio menu.

1 Press  to access the menu.

2 Press  or  to Utilities and press  to select.

3 Press  or  to Radio Settings and press  to select.

4 Press  or  to Tones/Alerts and press  to select.

5 Press  or  to All Tones and press  to select.

6 Press  to enable/disable all tones and alerts.



The display shows  beside Enabled.



The ✓ disappears from beside Enabled.



Setting the Tone Alert Volume Offset Level



You can adjust the Tone Alert Volume Offset level if needed. This feature adjusts the volume of the tones/alerts, allowing it to be higher or lower than the voice volume.



- 1 Press  to access the menu.



- 2 Press  or  to Utilities and press  to select.

- 3 Press  or  to Radio Settings and press  to select.

- 4 Press  or  to Tones/Alerts and press  to select.

- 5 Press  or  to Vol. Offset and press  to select.



- 6 Press  or  to the required volume value.
The radio sounds a feedback tone with each corresponding volume value.



- 7 Do one of the following:
 - Press  to keep the required displayed volume value.
 - Press  to exit without changing the current volume offset settings.



Turning the Talk Permit Tone On or Off

You can enable and disable the Talk Permit Tone if needed.



- 1 Press  to access the menu.

2 Press  or  to Utilities and press  to select.

3 Press  or  to Radio Settings and press  to select.

4 Press  or  to Tones/Alerts and press  to select.



5 Press  or  to Talk Permit and press  to select.



6 Press  to enable/disable the Talk Permit Tone.
The display shows  beside Enabled.
The  disappears from beside Enabled.



Turning the Power Up Alert Tone On or Off

You can enable and disable the Power Up Alert Tone if needed.

1 Press  to access the menu.

2 Press  or  to Utilities and press  to select.

3 Press  or  to Radio Settings and press  to select.

4 Press  or  to Tones/Alerts and press  to select.

5 Press  or  to Power Up and press  to select.

- 6 Press  to enable/disable the Power Up Alert Tone.

The display shows ✓ beside Enabled.

The ✓ disappears from beside Enabled.

Setting the Power Level

You can customize your radio power setting to high or low for each Connect Plus zone.



High enables communication with tower sites in Connect Plus mode located at a considerable distance from you.



Low enables communication with tower sites in Connect Plus mode in closer proximity.



Press the programmed **Power Level** button to toggle transmit power level between high and low.





Follow the procedure described next to access this feature via the radio menu.

- 1 Press  to access the menu.

- 2 Press  or  to Utilities and press  to select.

- 3 Press  or  to Radio Settings and press  to select.



- 4 Press  or  to Power and press  to select.



- 5 Press  or  to the required setting and press  to select.
- ✓ appears beside selected setting. At any time, long press  to return to the Home screen.
- Screen returns to the previous menu.



Changing the Display Mode



You can change radio display mode between Day or Night, as needed. This affects the color palette of the display.

- 1 Press  to access the menu.

- 2 Press  or  to Utilities and press  to select.

- 3 Press  or  to Radio Settings and press  to select.

- 4 Press  or  to Display and press  to select.
The display shows Day Mode and Night Mode.

- 5 Press  or  to the required setting and press  to enable. ✓ appears besides selected setting.

Adjusting the Display Brightness



You can adjust the display brightness of the radio as needed.









NOTICE:



Display brightness cannot be adjusted when Auto Brightness is enabled.

- 1 Press  to access the menu.



- 2 Press  or  to Utilities and press  to select.

- 3 Press  or  to Radio Settings and press  to select.

- 4 Press  or  to Display and press  to select.

- 5 Press  or  to **Brightness** and press  to select.



The display shows a progress bar.



- 6 Decrease display brightness by pressing  or increase the display brightness by pressing .
- Select from setting of 1 to 8. Press  to confirm your entry.
-



Turning the Introduction Screen On or Off



You can enable and disable the Introduction Screen if needed.

- 1 Press  to access the menu.
-

- 2 Press  or  to **Utilities** and press  to select.
-

- 3 Press  or  to **Radio Settings** and press  to select.
-

- 4 Press  or  to **Display** and press  to select.
-

- 5 Press  or  to **Intro Screen** and press  to select.
-

- 6 Press  to enable/disable the Introduction Screen.



The display shows  beside **Enabled**.



The  disappears from beside **Enabled**.



Language



You can set your radio display to be in your required language.

- 1 Press  to access the menu.

- 2 Press  or  to Utilities and press  to select.

- 3 Press  or  to Radio Settings and press  to select.



- 4 Press  or  to Languages and press  to select.



- 5 Press  or  to the required language and press  to enable. ✓ appears beside selected language.



Turning the LED Indicator On or Off

You can enable and disable the LED Indicator if needed.

- 1 Press  to access the menu.

- 2 Press  or  to Utilities and press  to select.

- 3 Press  or  to Radio Settings and press  to select.



- 4 Press  or  to LED Indicator and press  to select.



- 5 Press  to enable/disable the LED Indicator.
The display shows ✓ beside Enabled.
The ✓ disappears from beside Enabled.



Identifying Cable Type

You can select the type of cable your radio uses.

- 1 Press  to access the menu.

- 2 Press  or  to Utilities and press  to select.

- 3 Press  or  to Radio Settings and press  to select.

- 4 Press  or  to Cable Type and press  to select.



- 5 The current cable type is indicated by a .



Voice Announcement





This feature enables the radio to audibly indicate the current Zone or Channel the user has just assigned, or programmable button press. This audio indicator can be customized per customer requirements. This is typically





useful when the user is in a difficult condition to read the content shown on the display.

- 1 Press  to access the menu.

- 2 Press  or  to Utilities and press  to select.

- 3 Press  or  to Radio Settings and press  to select.



- 4 Press  or  to Voice Announcement and press  to select.
You can also use  or  to change the selected option.



- 5 Do one of the following:
 - Press  to enable Voice Announcement. The display shows  beside Enabled.
 - Press  to disable Voice Announcement. The  disappears from beside Enabled.



Menu Timer



Set the period of time your radio stays in the menu before it automatically switches to the Home screen.



- 1 Press  to access the menu.

- 2 Press  or  to Utilities and press  to select.

- 3 Press  or  to Radio Settings and press  to select.

- 4 Press  or  to Display and press  to select.

- 5 Press  or  to Menu Timer and press  to select.



- 6 Press  or  to the required setting and press  to select.



Turning Horns/Lights On or Off



This feature needs to be installed through the rear accessory connector of your radio by your dealer.



Your radio is able to notify you of an incoming call via the horns and lights feature. When activated, an incoming call sounds your vehicle's horn and turns on its lights.

- 1 Do one of the following:
 - Press the programmed **Horns/Lights** button to toggle horns and light feature on or off. Skip the following steps.
 - Press  to access the menu.

- 2 Press  or  to Utilities and press  to select.

- 3 Press  or  to Radio Settings and press  to select.



4 Press  or  to Horn/Lights and press  to select.



5 Press  to enable/disable Horns/Lights.
The display shows  beside Enabled.
The  disappears from beside Enabled.



Setting Dual Knob Operation Preference





Your radio has a dual-purpose **Volume/Channel Knob**. Disabling the dual-purpose option sets the knob to work as a Volume Knob only.

1  to access the menu.

2  or  to Utilities and press  to select.

3  or  to Radio Settings and press  to select.



4  or  to Dual Knob and press  to select.



5 The display shows Volume Only and Volume & Ch.
 or  to the required setting and press  to select.
 appears beside selected setting.
Screen returns to the previous menu.



Digital Mic AGC (Mic AGC-D)

This feature controls the your radio's microphone gain automatically while transmitting on a digital system. It suppresses loud audio or boosts soft audio to a preset value in order to provide a consistent level of audio.





1 Press  to access the menu.

2 Press  or  to Utilities and press  to select.

3 Press  or  to Radio Settings and press  to select.

4 Press  or  to Mic AGC-D and press  to select.

5 Do one of the following:











- Press  to enable **Mic AGC-D**. The display shows  beside Enabled.
- Press  to disable **Mic AGC-D**. The  disappears from beside Enabled.

Intelligent Audio

Your radio can automatically adjust its audio volume to overcome background noise in the environment, inclusive of all stationary and non-stationary noise sources. This

feature is a Receive-only feature and does not affect Transmit audio.

1 Press  to access the menu.

Radio Control Steps	
Menu	<p>a Press  to access the menu.</p> <p>b Press  or  to Radio Settings and press  to select.</p> <p>c Press  or  to Radio Settings and press  to select.</p> <p>d Press  or  to Intelligent Audio and press  to select.</p>



Radio
Control



Steps



**NOTICE:**



You can also use or to change the selected option.

e Do one of the following:



- Press  to enable Intelligent Audio. The display shows ✓ beside Enabled.
- Press  to disable Intelligent Audio. The ✓ disappears from beside Enabled.

2 Press  or  to Utilities and press  to select.

3 Press  or  to Radio Settings and press  to select.

4 Press  or  to Intelligent Audio and press  to select.

5 Do one of the following:



- Press  to enable Intelligent Audio. The display shows ✓ beside Enabled.
- Press  to disable Intelligent Audio. The ✓ disappears from beside Enabled.



See [Authorized Accessories List](#) for recommended Bluetooth-enabled audio accessories with in-built Automatic Volume Control for similar performance.



Turning the Acoustic Feedback Suppressor Feature On or Off

This feature allows you to minimize acoustic feedback in received calls.

1 Press  to access the menu.





2 Press  or  to **Utilities** and press  to select.

3 Press  or  to **Radio Settings** and press  to select.

4 Press  or  to **AF Suppressor** and press  to select.

You can also use  or  to change the selected option.

5 Do one of the following.

- Press  to enable Acoustic Feedback Suppressor. The display shows  beside **Enabled**.
 - Press  to disable Acoustic Feedback Suppressor. The  disappears from beside **Enabled**.
-

Turning GNSS On or Off

Global Navigation Satellite System (GNSS) is a satellite navigation system that determines the radio precise location. GNSS includes Global Positioning System (GPS), Global Navigation Satellite System (GLONASS), and BeiDou Navigation Satellite System (BDS).









NOTICE:

Selected radio models may offer GPS, GLONASS, and BDS. GNSS constellation is configured by using CPS. Check with your dealer or system administrator to determine how your radio has been programmed.



1 Do one of the following:

- Press the programmed **GNSS** button to toggle the feature on or off. Skip the following steps.
 - Press  to access the menu.
-

2 Press  or  to **Utilities**. Press  to select.

3 Press  or  to Radio Settings. Press  to select.

4 Press  or  to GNSS. Press  to select.

5 Press  to enable/disable GNSS.
 If enabled,  appears beside Enabled.
 If disabled,  disappears beside Enabled.



See [Checking the GNSS Information on page 327](#) for details on retrieving GNSS information.

Accessing General Radio Information

Your radio contains information on the following:

- Battery
- Degree of Tilt (Accelerometer)
- Radio Model Number Index
- Option Board Over-the-Air (OTA) Codeplug CRC
- Site Number



- Site Info
- Radio Alias and ID
- Firmware and Codeplug Versions
- GNSS Information

Press  at any time to return to the previous screen or long press  to return to the Home screen. The radio exits the current screen once the inactivity timer expires.



Checking the Radio Model Number Index

This index number identifies your radio model-specific hardware. Your radio system administrator may ask for this number when preparing a new Option Board codeplug for your radio.

1 Press  to access the menu.

2 Press  or  to Utilities and press  to select.

3 Press  or  to Radio Info and press  to select.



4 Press  or  to Model Index and press  to select.

The display shows the Model Number Index.



Checking the CRC of the Option Board OTA Codeplug File

Follow the instructions below if your radio system administrator asks you to view the Option Board OTA Codeplug File CRC (Cyclic Redundancy Check). This menu option only appears if the Option Board received its last codeplug update OTA.

1 Press  to access the menu.

2 Press  or  to Utilities and press  to select.

3 Press  or  to Radio Info and press  to select.

4 Press  or  to OB OTA CPcrc and press  to select.

The display shows some letters and numbers. Communicate this information to your radio system administrator exactly as shown.

Displaying the Site ID (Site Number)









NOTICE:



If you are not currently registered at a site, the display shows Not Registered.

The radio briefly shows the Site ID as it registers with a Connect Plus site. Following registration, the radio does not generally indicate the Site number. To display the registered Site number, do the following:

1 Press  to access the menu.

2 Press  or  to Utilities and press  to select.

3 Press  or  to Radio Info and press  to select.

4 Press  or  to Site Number and press  to select.

The display shows the Network ID and the Site Number.

Checking the Site Info



NOTICE:

If you are not currently registered at a site, the display shows Not Registered.



The Site Info feature provides information that can be useful to a service technician. It consists of the following information:



- Repeater number of current Control Channel repeater.



- RSSI: Last signal strength value measured from Control Channel repeater.
- Neighbor List sent by Control Channel repeater (five numbers separated by commas).

If you are requested to use this feature, please report the displayed information exactly as it appears on the screen.

1 Press  to access the menu.

2 Press  or  to Utilities and press  to select.

3 Press  or  to Radio Info and press  to select.

4 Press  or  to Site Info and press  to select.



The display shows the Site Info.



Checking the Radio ID



This feature displays the ID of your radio.

Follow the procedure described next to access this feature via the radio screen.

- 1 Press  to access the menu.

- 2 Press  or  to Utilities and press  to select.



- 3 Press  or  to Radio Info and press  to select.

- 4 Press  or  to My ID and press  to select.
The display shows the radio ID.



Checking the Firmware Version and Codeplug Version

Displays the firmware version on your radio.

- 1 Press  to access the menu.

- 2 Press  or  to Utilities and press  to select.

- 3 Press  or  to Radio Info and press  to select.

- 4 Press  or  to Versions and press  to select.

The display a list with the following information:

- (Radio) Firmware Version
- (Radio) Codeplug Version
- Option Board Firmware Version
- Option Board Frequency Version
- Option Board Hardware Version
- Option Board Codeplug Version

Checking for Updates

Connect Plus provides the ability to update certain files (Option Board Codeplug, Network Frequency File, and Option Board Firmware File) Over-The-Air (OTA).



NOTICE:

Check with the dealer or network administrator to determine whether this feature has been enabled for your radio.

Any display Connect Plus radio has the ability to show its current Option Board OTA Codeplug CRC, Frequency File version or Option Board firmware file version by using a menu option. In addition, display radios that have been enabled for over-the-air file transfer can display the version of a "pending file". A "pending file" is a Frequency File or Option Board firmware file that the Connect Plus radio knows about through system messaging, but the radio has not yet collected all of the file packets. If a display Connect Plus radio has a pending file, the menu provides options to:

- See the version number of the pending file.
- See what percentage of packets has been collected so far.
- Request the Connect Plus radio to resume collecting file packets.

If the radio is enabled for Connect Plus OTA file transfer, there may be times when the radio automatically joins a file transfer without first notifying the radio user. While the radio is collecting file packets, the LED rapidly blinks red and the radio displays the High Volume Data icon on the Home Screen status bar.



NOTICE:

The Connect Plus radio cannot collect file packets and receive calls at the same time. If you wish to cancel the file transfer, press and release the **PTT** button. This causes the radio to request a call on the selected Contact Name, and it will also cancel the file transfer for that radio until the process resumes at a later time.

There are several things that can make the file transfer process start again. The first example applies to all OTA file types. The other examples apply only to the Network Frequency File and Option Board Firmware File:

- The radio system administrator re-initiates the OTA file transfer.
- The Option Board pre-defined timer expires, which causes the Option Board to automatically resume the process of collecting packets.

- The timer has not yet expired, but the radio user requests the file transfer to resume through the menu option.

After the Connect Plus radio finishes downloading all file packets, it must upgrade to the newly acquired file. For the Network Frequency File, this is an automatic process and does not require a radio reset. For the Option Board Codeplug File, this is an automatic process that will cause a brief interruption to service as the Option Board loads the new codeplug information and re-acquires a network site. How quickly the radio upgrades to a new Option Board firmware file depend on how the radio has been configured by the dealer or system administrator. The radio will either upgrade immediately after collecting all file packets, or it will wait until the next time that the user turns the radio on.

**NOTICE:**

Check with your dealer or system administrator to determine how your radio has been programmed.

The process of upgrading to a new Option Board firmware file takes several seconds, and it requires the Connect Plus Option Board to reset the radio. Once the upgrade starts, the radio user will not be able to make or receive calls until the process is completed. During the process, radio display prompts user to not turn off the radio.

Firmware File



The following section provides information on the radio firmware.



Firmware Up to Date



**NOTICE:**



If the Option Board firmware file is not Up to Date (and if the radio has partially collected a more recent Option Board firmware file version) the radio displays a list with additional options; `Version`, `%Received`, and `Download`.

- 1 Press  to access the menu.

- 2 Press  or  to `Utilities` and press  to select.

- 3 Press  or  to `Radio Info` and press  to select.



- 4 Press  or  to `Updates` and press  to select.

- 5 Press  or  to Firmware and press  to select.



The display shows Firmware is Up to Date.



Pending Firmware – Version



- 1 Press  to access the menu.
-

- 2 Press  or  to Utilities and press  to select.
-

- 3 Press  or  to Radio Info and press  to select.
-

- 4 Press  or  to Updates and press  to select.
-

- 5 Press  or  to Firmware and press  to select.
-



- 6 Press  or  to Version and press  to select.

If there is a pending Option Board firmware file, the display shows the pending firmware version number.



If there is a pending Option Board firmware file, the display shows Firmware is Up to Date.



Pending Firmware – % Received



- 1 Press  to access the menu.
-

- 2 Press  or  to Utilities and press  to select.
-

- 3 Press  or  to Radio Info and press  to select.
-

- 4 Press  or  to Updates and press  to select.
-

5 Press  or  to `Firmware` and press  to select.

6 Press  or  to `%Received` and press  to select.

The screen displays the percentage of firmware file packets collected so far.



NOTICE:



When at 100%, the radio needs to be power cycled Off and then On to initiate the firmware upgrade.

Pending Firmware – Download

If the Connect Plus radio has previously left an OTA Option Board Firmware File Transfer with a partial file, the unit automatically rejoins the file transfer (if still ongoing) when an internal timer expires. If you want the unit to rejoin an ongoing Option Board Firmware File transfer prior to



expiration of this internal timer, use the Download option as described below.

1 Press  to access the menu.

2 Press  or  to `Utilities` and press  to select.

3 Press  or  to `Radio Info` and press  to select.

4 Press  or  to `Updates` and press  to select.

5 Press  or  to `Firmware` and press  to select.



6 Press  or  to `Download` and press  to select.

The display shows the following:

Download Available	Start Download
--------------------	----------------

No Download Available	Download not available
-----------------------	------------------------

7 Do one of the following:

- Select Yes and press  to start the download.
- Select No and press  to return to the previous menu.

Frequency File

The following section provides information on the frequency file of the radio.



Frequency File Up to Date







NOTICE:

If the Frequency File is not Up to Date (and if the radio has partially collected a more recent frequency file version) the radio displays a list with additional options; Version, %Received, and Download.

1 Press  to access the menu.

2 Press  or  to Utilities and press  to select.



3 Press  or  to Radio Info and press  to select.

4 Press  or  to Frequency and press  to select.

The display shows Freq. File is Up to Date.



Frequency File Pending – Version



1 Press  to access the menu.

2 Press  or  to Utilities and press  to select.

3 Press  or  to Radio Info and press  to select.

4 Press  or  to Updates and press  to select.



5 Press  or  to Frequency and press  to select.

6 Press  or  to Version and press  to select.



If there is a pending Frequency File, the display shows the pending Frequency File version number.



Frequency File Pending – % Received

1 Press  to access the menu.

2 Press  or  to Utilities and press  to select.

3 Press  or  to Radio Info and press  to select.

4 Press  or  to Updates and press  to select.



5 Press  or  to %Received and press  to select.



The screen displays the percentage of frequency file packets collected so far.



Frequency File Pending – Download



If the Connect Plus radio has previously left an OTA Network Frequency File Transfer with a partial file, the unit automatically rejoins the file transfer (if still ongoing) when an internal timer expires. If you want the unit to rejoin an ongoing Network Frequency File transfer prior to expiration of this internal timer, use the Download option as described below.

1 Press  to access the menu.

2 Press  or  to Utilities and press  to select.

3 Press  or  to Radio Info and press  to select.

4 Press  or  to Updates and press  to select.

5 Press  or  to Frequency and press  to select.

6 Press  or  to Download and press  to select.

Download Currently Unavailable	Download not available
Download Currently Available	Start Download

7 Do one of the following:
• Select Yes and press to start the download.



- Select No and press to return to the previous menu.

Checking the GNSS Information



Displays the GNSS information on your radio, such as values of:



- Latitude
- Longitude
- Altitude
- Direction
- Velocity
- Horizontal Dilution of Precision (HDOP)
- Satellites
- Version

1 Press  to access the menu.

2 Press  or  to Utilities and press  to select.

3 Press  or  to Radio Info and press  to select.

4 Press  or  to GNSS Info and press  to select.



5 Press  or  to the required item and press  to select.
The display shows the requested GNSS information.

See [Turning GNSS On or Off on page 316](#) for details on GNSS.



Viewing Enterprise Wi-Fi Certificate Details

You can view the details of the selected Enterprise Wi-Fi Certificate.

1 Press  to access the menu.

2 Press  or  to Utilities. Press  to select.

3 Press  or  to Certificate Menu. Press  to select.
✓ appears beside ready certificates.

4 Press  or  to the required certificate.
Press  to select.

Your radio displays the full details of the certificate.



NOTICE:

For unready certificates, the display shows only Status.

Other Systems

Features that are available to the radio users under this system are available in this chapter.

Push-To-Talk Button

The Push-to-Talk (**PTT**) button serves two basic purposes:

- While a call is in progress, the **PTT** button allows the radio to transmit to other radios in the call. The microphone is activated when the **PTT** button is pressed.
- While a call is not in progress, the **PTT** button is used to make a new call.

Long press the **PTT** button to talk. Release the **PTT** button to listen.

If the Talk Permit Tone or the PTT Sidetone  is enabled, wait until the short alert tone ends before talking.

 If the Channel Free Indication feature is enabled on your radio (programmed by your dealer), you hear a short alert tone the moment the target radio (the radio that is receiving your call) releases the **PTT** button, indicating the channel is free for you to respond.

 You hear a continuous Talk Prohibit Tone if your call is interrupted. You should release the **PTT** button if you hear a continuous Talk Prohibit Tone.

Programmable Buttons

Depending on the duration of a button press, your dealer can program the programmable buttons as shortcuts to radio functions.

Short press

Pressing and releasing rapidly.

Long press

Pressing and holding for the programmed duration.



NOTICE:

See [Emergency Operation on page 408](#) for more information on the programmed duration of the **Emergency** button.

Assignable Radio Functions

The following radio functions can be assigned to the programmable buttons.

Audio Ambience

Allows the user to select an environment the radio is operating in.

Audio Profiles

Allows the user to select the preferred audio profile.

Bluetooth® Audio Switch

Toggles audio routing between internal radio speaker and external Bluetooth-enabled accessory.

Bluetooth Connect

Initiates a Bluetooth find-and-connect operation.

Bluetooth Disconnect

Terminates all existing Bluetooth connections between your radio and any Bluetooth-enabled devices.

Bluetooth Discoverable

Enables your radio to enter Bluetooth Discoverable Mode.

Call Alert

Provides direct access to the contacts list for you to select a contact to whom a Call Alert can be sent.

Call Forwarding

Toggles Call Forwarding on or off.

Call Log

Selects the call log list.

Channel Announcement

Plays zone and channel announcement voice messages for the current channel.

Contacts

Provides direct access to the Contacts list.

Emergency

Depending on the programming, initiates or cancels an emergency.

Ext Public Address (PA)

Toggles audio routing between the connected PA loudspeaker amplifier and the internal PA system of the radio.

Indoor Location

Toggles Indoor Location on or off.

Intelligent Audio

Toggles intelligent audio on or off.

Manual Dial

Initiates a Private Call by keying in any subscriber ID.

Manual Site Roam ⁷

Starts the manual site search.

⁷ Not applicable in Capacity Plus.

Mic AGC

Toggles the internal microphone automatic gain control (AGC) on or off.

Monitor

Monitors a selected channel for activity.

Notifications

Provides direct access to the Notifications list.

Nuisance Channel Delete⁷

Temporarily removes an unwanted channel, except for the Selected Channel, from the scan list. The Selected Channel refers to the selected zone or channel combination of the user from which scan is initiated.

One Touch Access 

Directly initiates a predefined Private, Phone or Group Call, a Call Alert, a Quick Text message, or Home Revert.

Option Board Feature

Toggles option board feature(s) on or off for option board-enabled channels.

Permanent Monitor⁷

Monitors a selected channel for all radio traffic until function is disabled.

Phone 

Provides direct access to the Phone Contacts list.

Privacy 

Toggles privacy on or off.

Public Address (PA)

Toggles the internal PA system of the radio on or off.

Radio Alias and ID

Provides radio alias and ID.

Radio Check 

Determines if a radio is active in a system.

Radio Disable 

Allows a target radio to be remotely disabled.

Radio Enable 

Allows a target radio to be remotely enabled.

Remote Monitor

Turns on the microphone of a target radio without it giving any indicators.

Repeater/Talkaround⁷

Toggles between using a repeater and communicating directly with another radio.

Reset Home Channel

Sets a new home channel.

Silence Home Channel Reminder

Mutes the Home Channel Reminder.

Scan⁸

Toggles scan on or off.

Site Info

Displays the current site name and ID of Capacity Plus-Multi-Site.

Plays site announcement voice messages for the current site when Voice Announcement is enabled.

Site Lock⁷

When toggled on, the radio searches the current site only. When toggled off, the radio searches other sites in addition to the current site.

Telemetry Control

Controls the Output Pin on a local or remote radio.

Text Message

Selects the text message menu.

Transmit Interrupt Remote Dekey

Stops an ongoing interruptible call to free the channel.

Trill Enhancement

Toggles trill enhancement on or off.

Voice Announcement On/Off

Toggles voice announcement on or off.

Voice Operating Transmission (VOX)

Toggles VOX on or off.

Wi-Fi

Toggles Wi-Fi on or off.

Zone Selection

Allows selection from a list of zones.

Assignable Settings or Utility Functions

The following radio settings or utility functions can be assigned to the programmable buttons.

Tones/Alerts

Toggles all tones and alerts on or off.

Backlight

Toggles display backlight on or off.

Channel Up/Down

Depending on the programming, changes channel to previous or next channel.

⁸ Not applicable in Capacity Plus–Single-Site.

Display Mode

Toggles the day/night display mode on or off.

Power Level

Toggles transmit power level between high and low.

Accessing Programmed Functions

Follow the procedure to access programmed functions in your radio.

1 Do one of the following:

- Press the programmed button. Proceed to [step 3](#).
- Press  to access the menu.

2 Press or to the menu function, and press to select a function or enter a sub-menu.

3 Do one of the following:

- Press  to return to the previous screen.

- Long press  to return to the Home screen.

Your radio automatically exits the menu after a period of inactivity and returns to the Home screen.

The Menu Navigation Buttons are also available on a keypad microphone. See [Keypad Microphone Buttons on page 37](#).

Status Indicators

This chapter explains the status indicators and audio tones used in the radio.

Icons

The Liquid Crystal Display (LCD) of your radio shows the radio status, text entries, and menu entries.









Table 9: Display Icons







The following icons appear on the status bar at the top of the radio display. The icons are arranged left most in order of appearance or usage, and are channel-specific.

	<p>BeiDou Only Available ⁹ </p> <p>BeiDou Only feature is enabled. The icon stays lit when a position fix is available.</p>
--	---







	<p>Bluetooth Connected</p> <p>The Bluetooth feature is enabled. The icon stays lit when a remote Bluetooth device is connected.</p>
	<p>Bluetooth Not Connected</p> <p>The Bluetooth feature is enabled but there is no remote Bluetooth device connected.</p>
	<p>Call Log</p> <p>Radio call log.</p>
	<p>Contact</p> <p>Radio contact is available.</p>
	<p>Emergency</p> <p>Radio is in Emergency mode.</p>
	<p>Flexible Receive List</p> <p>Flexible receive list is enabled.</p>







⁹ Only applicable for XiR M8660i/XiR M8668i/CM7668i.

	GNSS Available  GNSS feature is enabled. The icon stays lit when a position fix is available.
	GNSS Not Available  GNSS feature is enabled but is not receiving data from the satellite.
	High Volume Data Radio is receiving high volume data and channel is busy.
	Indoor Location Available ¹⁰ Indoor location status is on and available.
	Indoor Location Unavailable ¹⁰ Indoor location status is on but unavailable due to Bluetooth disabled or Beacons Scan suspended by Bluetooth.
	Message Incoming message.

	Monitor Selected channel is being monitored.
	Mute Mode Mute Mode is enabled and speaker is muted.
	Notification Notification List has one or more missed events.
	Option Board The Option Board is enabled. (Option board enabled models only.)
	Option Board Non-Function The Option Board is disabled.
	Over-the-Air Programming Delay Timer Indicates time left before automatic restart of radio.









¹⁰ Only applicable for models with the latest software and hardware.

	<p>Received Signal Strength Indicator (RSSI)</p> <p>The number of bars displayed represents the radio signal strength. Four bars indicate the strongest signal. This icon is only displayed while receiving.</p>
	<p>Response Inhibit</p> <p>Response Inhibit is enabled.</p>
	<p>Ring Only</p> <p>Ringing mode is enabled.</p>
	<p>Scan¹¹</p> <p>Scan feature is enabled.</p>
	<p>Scan-Priority 1¹¹</p> <p>Radio detects activity on channel/group designated as Priority 1.</p>
	<p>Scan-Priority 2¹¹</p> <p>Radio detects activity on channel/group designated as Priority 2.</p>

	<p>Secure</p> <p>The Privacy feature is enabled.</p>
	<p>Sign In</p> <p>Radio is signed in to the remote server.</p>
	<p>Sign Out</p> <p>Radio is signed out of the remote server.</p>
	<p>Silent Ring</p> <p>Silent ring mode is enabled.</p>
	<p>Site Roaming¹²</p> <p>The site roaming feature is enabled.</p>
	<p>Talkaround¹¹</p> <p>In the absence of a repeater, the radio is configured for direct radio to radio communication.</p>

¹¹ Not applicable in Capacity Plus.

¹² Not applicable in Capacity Plus–Single-Site.

	Tones Disable Tones are turned off.
	Unsecure The Privacy feature is disabled.
	Vote Scan Vote scan feature is enabled.
	Wi-Fi Excellent ¹³ Wi-Fi signal is excellent.
	Wi-Fi Good ¹³ Wi-Fi signal is good.
	Wi-Fi Average ¹³ Wi-Fi signal is average.
	Wi-Fi Poor ¹³ Wi-Fi signal is poor.
	Wi-Fi Unavailable ¹³ Wi-Fi signal is unavailable.

¹³ Only applicable for XiR M8668i/CM7668i .

Table 10: Advance Menu Icons

The following icons appear beside menu items that offer a choice between two options or as an indication that there is a sub-menu offering two options.





	Checkbox (Checked) Indicates that the option is selected.
	Checkbox (Empty) Indicates that the option is not selected.
	Solid Black Box Indicates that the option selected for the menu item with a sub-menu.

Table 11: Bluetooth Device Icons

The following icons appear next to items in the list of Bluetooth-enabled devices available to indicate the device type.

	Bluetooth Audio Device Bluetooth-enabled audio device, such as a headset.
---	---





	<p>Bluetooth Data Device Bluetooth-enabled data device, such as a scanner.</p>
	<p>Bluetooth PTT Device Bluetooth-enabled PTT device, such as a PTT-Only Device (POD).</p>

Table 12: Call Icons

The following icons appear on the display during a call. These icons also appear in the Contacts list to indicate alias or ID type.

	<p>Bluetooth PC Call Indicates a Bluetooth PC Call in progress.</p> <p>In the Contacts list, it indicates a Bluetooth PC Call alias (name) or ID (number).</p>
	<p>Dispatch Call The Dispatch Call contact type is used to send a text message to a dispatcher PC through a third-party Text Message Server.</p>











	<p>Group Call/All Call Indicates a Group Call or All Call in progress.</p> <p>In the Contacts list, it indicates a group alias (name) or ID (number).</p>
	<p>Private Call Indicates a Private Call in progress.</p> <p>In the Contacts list, it indicates a subscriber alias (name) or ID (number).</p>
	<p>Phone Call as Group/All Call Indicates a Phone Call as Group Call or All Call in progress.</p> <p>In the Contacts list, it indicates a group alias (name) or ID (number).</p>
	<p>Phone Call as Private Call Indicates a Phone Call as Private Call in progress.</p> <p>In the Contacts list, it indicates a phone alias (name) or ID (number).</p>

Table 13: Job Tickets Icons

The following icons appear momentarily on the display in the Job Ticket folder.

	All Jobs Indicates all jobs listed.
	New Jobs Indicates new jobs.
	In Progress Jobs are transmitting. This is seen before indication for Job Tickets Send Failed or Sent Successfully.
	Send Failed Jobs cannot be sent.
	Sent Successfully Jobs have been successfully sent.
	Priority 1 Indicates Priority Level 1 for jobs.



	Priority 2 Indicates Priority Level 2 for jobs.
	Priority 3 Indicates Priority Level 3 for jobs.

Table 14: Mini Notice Icons

The following icons appear momentarily on the display after an action to perform a task is taken.









	Failed Transmission (Negative) Failed action taken.
	Successful Transmission (Positive) Successful action taken.
	Transmission in Progress (Transitional) Transmitting. This is seen before indication for Successful Transmission or Failed Transmission.

Table 15: Sent Items Icons

The following icons appear at the top right corner of the display in the Sent Items folder.

	<p>In Progress</p> <p>The text message to a subscriber alias or ID is pending transmission, followed by waiting for acknowledgment.</p> <p>The text message to a group alias or ID is pending transmission.</p>
	<p>Individual or Group Message Read</p> <p>The text message has been read.</p>
	<p>Individual or Group Message Unread</p> <p>The text message has not been read.</p>

	<p>Send Failed</p> <p>The text message cannot be sent.</p>
	<p>Sent Successfully</p> <p>The text message has been successfully sent.</p>

LED Indicators

LED indicators show the operational status of your radio.

Blinking Red

Radio has failed the self-test upon powering up.

Radio is receiving an emergency transmission.

Radio is transmitting in low battery state.

Radio has moved out of range if Auto-Range Transponder System is configured.

Mute Mode is enabled.

Solid Green

Radio is powering up.

Radio is transmitting.

Radio is sending a Call Alert or an emergency transmission.

Blinking Green

Radio is receiving a call or data.

Radio is retrieving Over-the-Air Programming transmissions.

Radio is detecting activity over the air.



NOTICE:

This activity may or may not affect the programmed channel of the radio due to the nature of the digital protocol.

There is no LED indication when the radio is detecting activity over the air in Capacity Plus.

Double Blinking Green

Radio is receiving a privacy-enabled call or data.

Solid Yellow

Radio is monitoring a conventional channel.

Radio is in Bluetooth Discoverable Mode.

Blinking Yellow

Radio is scanning for activity.

Radio has yet to respond to a Call Alert.

Radio has Flexible Receive List enabled.

All Capacity Plus-Multi-Site channels are busy.

Double Blinking Yellow

Radio has Auto Roaming enabled.

Radio is actively searching for a new site.

Radio has yet to respond to a Group Call Alert.

Radio is locked.

Radio is not connected to the repeater while in Capacity Plus.

All Capacity Plus channels are busy.

Tones

The following are the tones that sound through on the radio speaker.



High Pitched Tone



Low Pitched Tone

Indicator Tones

Indicator tones provide you with audible indications of the status after an action to perform a task is taken.



Positive Indicator Tone



Negative Indicator Tone

Audio Tones

Audio tones provide you with audible indications of the status, or response to data received on the radio.



Continuous Tone

A monotone sound. Sounds continuously until termination.



Periodic Tone

Sounds periodically depending on the duration set by the radio. Tone starts, stops, and repeats itself.



Repetitive Tone

A single tone that repeats itself until it is terminated by the user.



Momentary Tone

Sounds once for a short duration set by the radio.

Conventional Analog and Digital Modes

Each channel in your radio can be configured as a conventional analog or conventional digital channel.

Use the **Channel Rocker** to switch between an analog or a digital channel.

Certain features are unavailable when switching from digital to analog mode. The icons for digital features reflect this change by appearing “grayed out”. The disabled features are hidden in the menu.

Your radio also has features available in both analog and digital modes. The minor differences in the way each feature works do **not** affect the performance of your radio.

**NOTICE:**

Your radio also switches between digital and analog modes during a dual mode scan. See [Scan on page 389](#) for more information.

Icon Information

Throughout this publication, the icons described are used to indicate features supported in either the conventional analog or conventional digital mode, or made available with a keypad-enabled microphone.



Indicates a conventional **Analog Mode-Only** feature.



Indicates a conventional **Digital Mode-Only** feature.

For features that are available in **both** conventional analog and digital modes, both icons are **not** shown.

IP Site Connect

This feature allows your radio to extend conventional communication beyond the reach of a single site by connecting to different available sites by using an Internet Protocol (IP) network. This is a conventional multi-site mode.

When the radio moves out of range from one site and into the range of another, the radio connects to the repeater of the new site to send or receive calls or data transmissions. This is done either automatically or manually depending on your settings.

In an automatic site search, the radio scans through all available sites when the signal from the current site is weak or when the radio is unable to detect any signal from the current site. The radio then locks on to the repeater with the strongest Received Signal Strength Indicator (RSSI) value.

In a manual site search, the radio searches for the next site in the roam list that is currently in range but which may not have the strongest signal and locks on to the repeater.

**NOTICE:**

Each channel can only have either Scan or Roam enabled, not both at the same time.

Channels with this feature enabled can be added to a particular roam list. The radio searches the channels in the roam list during the automatic roam operation to locate the best site. A roam list supports a maximum of 16 channels, including the selected channel.

**NOTICE:**

You cannot manually add or delete an entry in the roam list. Check with your dealer or system administrator for more information.

Capacity Plus–Single-Site

Capacity Plus–Single-Site is a single-site trunking configuration of the MOTOTRBO radio system, which uses a pool of channels to support hundreds of users and up to 254 Groups. This feature allows your radio to efficiently utilize the available number of programmed channels while in Repeater Mode.

You hear a negative indicator tone if you try to access a feature not applicable to Capacity Plus–Single-Site by using a programmable button press.

Your radio also has features that are available in conventional digital mode, IP Site Connect, and Capacity Plus. However, the minor differences in the way each

feature works does not affect the performance of your radio.

Check with your dealer or system administrator for more information on this configuration.

Capacity Plus–Multi-Site

Capacity Plus–Multi-Site is a multi-channel trunking configuration of the MOTOTRBO radio system, combining the best of both Capacity Plus and IP Site Connect configurations.

Capacity Plus–Multi-Site allows your radio to extend trunking communication beyond the reach of a single site, by connecting to different available sites which are connected with an IP network. It also provides an increase in capacity by efficiently utilizing the combined available number of programmed channels supported by each of the available sites.

When the radio moves out of range from one site and into the range of another, it connects to the repeater of the new site to send or receive calls/data transmissions. Depending on your settings, this is done automatically or manually.

If the radio is set to do this automatically, it scans through all available sites when the signal from the current site is weak or when the radio is unable to detect any signal from

the current site. It then locks on to the repeater with the strongest RSSI value.

In a manual site search, the radio searches for the next site in the roam list that is currently in range (but which may not have the strongest signal) and locks on to it.

Any channel with Capacity Plus–Multi-Site enabled can be added to a particular roam list. The radio searches these channels during the automatic roam operation to locate the best site.



NOTICE:

You cannot manually add or delete an entry to the roam list. Check with your dealer or system administrator for more information.

Similar to Capacity Plus–Single Site, icons of features not applicable to Capacity Plus–Multi-Site are not available in the menu. You hear a negative indicator tone if you try to access a feature not applicable to Capacity Plus–Multi-Site by using a programmable button press.

Zone and Channel Selections

This chapter explains the operations to select a zone or channel on your radio. A zone is a group of channels.





Your radio supports up to 99 channels and 2 zones, with a maximum of 99 channels per zone.



Each channel can be programmed with different features and/or support different groups of users.

Selecting Zones

Follow the procedure to select the required zone on your radio.





- 1 Do one of the following:
 - Press the programmed **Zone Selection** button. Proceed to [step 3](#).
 - Press  to access the menu.

 - 2 Press  or  to Zone. Press  to select. The display shows  and the current zone.
-

- 3 Press  or  to the required zone. Press  to select.
- The display shows <Zone> Selected momentarily and returns to the selected zone screen.
-

Selecting Zones by Using the Alias Search

Follow the procedure to select the required zone on your radio by using the alias search.

- 1 Press  to access the menu.
-
- 2 Press  or  to Zone. Press  to select.
- The display shows ✓ and the current zone.
-
- 3 Enter the first character of the required alias.
- The display shows a blinking cursor.
-
- 4 Enter the rest of the characters of the required alias.

The alias search is case-insensitive. If there are two or more entries with the same name, the display shows the entry listed first in the list.

The first text line shows the characters you entered. The following text lines show the shortlisted search results.

- 5 Press  to select.
- The display shows <Zone> Selected momentarily and returns to the selected zone screen.
-

Selecting Channels

Follow the procedure to select the required channel on your radio after you have selected a zone.

Do one of the following:

- Press the **Scroll Up/Down** button.
 - Use the **Volume/Channel Knob**.
 - Press the programmed **Channel Up/Down** buttons.
-

Calls

This chapter explains the operations to receive, respond to, make, and stop calls.

You can select a subscriber alias or ID, or group alias or ID after you have selected a channel by using one of these features:

Alias Search

This method is used for Group, Private, and All Calls only with a keypad microphone.

Contacts List

This method provides direct access to the Contacts list.

Manual Dial (by using Contacts)

This method is used for Private and Phone Calls only with a keypad microphone.

Programmed Number Keys

This method is used for Group, Private, and All Calls only with a keypad microphone.



NOTICE:

You can only have one alias or ID assigned to a number key, but you can have more than one number key associated to an alias or ID. All the number keys on a keypad microphone can be assigned. See [Assigning Entries to Programmable Number Keys on page 394](#) for more information.

Programmed One Touch Access Button

This method is used for Group, Private, and Phone Calls only.

You can only have one ID assigned to a **One Touch Access** button with a short or long programmable button press. Your radio can have multiple **One Touch Access** buttons programmed.

Programmable Button

This method is used for Phone Calls only.

Volume/Channel Selector Knob

This method manually selects a subscriber alias or ID, or group alias or ID.

The LED lights up solid green while the radio is transmitting and blinks green when the radio is receiving.

**NOTICE:**

The LED lights up solid green while the radio is transmitting and double blinks green when the radio is receiving a privacy-enabled call.

To unscramble a privacy-enabled call, your radio must have the same Privacy Key, or the same Key Value and Key ID (programmed by your dealer), as the transmitting radio (the radio you are receiving the call from).

See [Privacy on page 443](#) for more information.

Group Calls

Your radio must be configured as part of a group to receive a call from or make a call to the group of users.

Making Group Calls

Follow the procedure to make Group Calls on your radio.

- 1 Do one of the following:
 - Select a channel with the active group alias or ID.
 - Press the programmed **One Touch Access** button.
-

- 2 Press the **PTT** button to make the call.
The green LED lights up. The display shows the **Group Call** icon and the group call alias.
-

- 3 Release the **PTT** button to listen.
The green LED lights up when the target radio responds. The display shows the **Group Call** icon, the group alias or ID, and the transmitting radio alias or ID.
-



- 4  If the Channel Free Indication feature is enabled, you hear a short alert tone the moment the transmitting radio releases the **PTT** button, indicating the channel is free for you to respond. Press the **PTT** button to respond to the call.



The call ends when there is no voice activity for a predetermined period. The radio returns to the screen you were on prior to initiating the call.
-

Making Group Calls by Using the Contacts List

Follow the procedure to make Group Calls on your radio by using the Contacts list.

- 1 Press  to access the menu.

- 2 Press  or  to **Contacts**. Press  to select.

- 3 Press  or  to the required alias or ID.
Press  to select.

- 4 Press the **PTT** button to make the call.
The green LED lights up.

- 5 Release the **PTT** button to listen.
The green LED blinks when any user in the group responds. The display shows the **Group Call** icon, and alias or ID, and the transmitting radio alias or ID.

- 6  If the Channel Free Indication feature is enabled, you hear a short alert tone the moment the transmitting radio releases the **PTT** button, indicating the channel is free for you to respond. Press the **PTT** button to respond to the call.

The call ends when there is no voice activity for a predetermined period.

Making Group Calls by Using the Programmable Number Key

Follow the procedure to make Group Calls on your radio by using the programmable number key.

- 1 Long press the programmed number key to the predefined alias or ID when you are on the Home screen.

If a number key is assigned to an entry in a particular mode, this feature is not supported when you long press the number key in another mode.

A negative indicator tone sounds if the number key is not associated to an entry.

- 2 Press the **PTT** button to make the call.

The green LED lights up.

- 3 Release the **PTT** button to listen.

The green LED blinks when any user in the group responds.

- 4  If the Channel Free Indication feature is enabled, you hear a short alert tone the moment the transmitting radio releases the **PTT** button, indicating the channel is free for you to respond. Press the **PTT** button to respond to the call.

The call ends when there is no voice activity for a predetermined period. The radio returns to the screen you were on before initiating the call.

See [Assigning Entries to Programmable Number Keys on page 394](#) for more information.



Responding to Group Calls

To receive a call from a group of users, your radio must be configured as part of that group. Follow the procedure to respond to Group Calls on your radio.

When you receive a Group Call:

- The green LED blinks.
- The display shows the **Group Call** icon at the top right corner.
- The first text line shows the caller alias.
- The second text line displays the group call alias.
- Your radio unmutes and the incoming call sounds through the speaker.

- 1 Do one of the following:

-  If the Channel Free Indication feature is enabled, you hear a short alert tone the moment the transmitting radio releases the **PTT** button, indicating the channel is free for you to respond. Press the **PTT** button to respond to the call.
-  If the Voice Interrupt feature is enabled, press the **PTT** button to interrupt the audio from the transmitting radio and free the channel for you to respond.

The green LED lights up.

- 2 Do one of the following:

- Wait for the Talk Permit Tone to end and speak clearly into the microphone if enabled.
-  Wait for the **PTT** Sidetone to end and speak clearly into the microphone if enabled.

3 Release the **PTT** button to listen.

The call ends when there is no voice activity for a predetermined period.

If the radio receives a Group Call while not on the Home screen, it remains on its current screen prior to answering the call.

Long press  to return to the Home screen to view the caller alias before replying.

Private Calls

A Private Call is a call from an individual radio to another individual radio.

There are two ways to set up a Private Call. The first type sets up the call after performing a radio presence check, while the second type sets up the call immediately. Only one of these types can be programmed to your radio by your dealer.

Making Private Calls

Your radio must be programmed to initiate a Private Call. If this feature is not enabled, a negative indicator tone sounds when you initiate the call. Follow the procedure to make Private Calls on your radio.

Use the Text Message or Call Alert features to contact an individual radio. For more information, see [Text Messaging on page 143](#) or [Call Alert Operation on page 404](#).

1 Do one of the following:

- Select a channel with the active subscriber alias or ID.
 - Press the programmed **One Touch Access** button.
-

2 Press the **PTT** button to make the call.

The green LED lights up. The display shows the **Private Call** icon, the subscriber alias, and call status.

3 Wait for the Talk Permit Tone to end and speak clearly into the microphone if enabled.

- 4 Release the **PTT** button to listen.

The green LED blinks when the target radio responds.



- 5  If the Channel Free Indication feature is enabled, you hear a short alert tone the moment the transmitting radio releases the **PTT** button, indicating the channel is free for you to respond. Press the **PTT** button to respond to the call.



The call ends when there is no voice activity for a predetermined period. A tone sounds. The display shows `Call Ended`.

Making Private Calls by Using the Contacts List

Follow the procedure to make Private Calls on your radio by using the Contacts list.

- 1 Press  to access the menu.
-

- 2 Press  or  to `Contacts`. Press  to select.
-

- 3 Press  or  to the required alias or ID. Press  to select.
-

- 4 Press the **PTT** button to make the call. The green LED lights up. The display shows the destination alias.
-

- 5 Wait for the Talk Permit Tone to end and speak clearly into the microphone if enabled.
-

- 6 Release the **PTT** button to listen. The green LED blinks when the target radio responds. The display shows the transmitting user alias or ID.
-



- 7  If the Channel Free Indication feature is enabled, you hear a short alert tone the moment the transmitting radio releases the **PTT** button, indicating the channel is free for you to respond. Press the **PTT** button to respond to the call.



The call ends when there is no voice activity for a predetermined period. A tone sounds. The display shows `Call Ended`.



Making Private Calls by Using the Manual Dial

Follow the procedure to make Private Calls on your radio by using the manual dial.



- 1 Press  to access the menu.

- 2 Press  or  to `Contacts`. Press  to select.

- 3 Press  or  to `Manual Dial`. Press  to select.

- 4 Press  or  to `Radio Number`. Press  to select.

- 5 Do one of the following:

- Enter the subscriber ID, and press  to proceed.
 - Edit the previously dialed subscriber ID, and press  to proceed.
-

- 6 Press the **PTT** button to make the call.

The green LED lights up. The display shows the destination alias.

- 7 Wait for the Talk Permit Tone to end and speak clearly into the microphone if enabled.
-

- 8 Release the **PTT** button to listen.

The green LED lights up when the target radio responds. The display shows the transmitting user alias or ID.

- 9  If the Channel Free Indication feature is enabled, you hear a short alert tone the moment the transmitting radio releases the **PTT** button, indicating the channel is free for you to respond. Press the **PTT** button to respond to the call.

The call ends when there is no voice activity for a predetermined period. A tone sounds. The display shows `Call Ended`.

Making Private Calls by Using the Programmable Number Key

Follow the procedure to make Private Calls on your radio by using the programmable number key.

- 1 Long press the programmed number key to the predefined alias or ID when you are on the Home screen.

If a number key is assigned to an entry in a particular mode, this feature is not supported when you long press the number key in another mode.

A negative indicator tone sounds if the number key is not associated to an entry.

- 2 Press the **PTT** button to make the call.

The green LED lights up. The display shows the **Private Call** icon at the top right corner. The first text line shows the caller alias. The second text line shows the call status.

- 3 Release the **PTT** button to listen.

The green LED blinks when the target radio responds. The display shows the destination alias.

- 4  If the Channel Free Indication feature is enabled, you hear a short alert tone the moment the transmitting radio releases the **PTT** button, indicating the channel is free for you to respond. Press the **PTT** button to respond to the call.

The call ends when there is no voice activity for a predetermined period. A tone sounds. The radio returns to the screen you were on before initiating the call.

See [Assigning Entries to Programmable Number Keys on page 394](#) for more information.

Responding to Private Calls



Follow the procedure to respond to Private Calls on your radio.

When you receive a Private Call:

- The green LED blinks.

- Your radio unmutes and the incoming call sounds through the speaker.

1 Do one of the following:

-  If the Channel Free Indication feature is enabled, you hear a short alert tone the moment the transmitting radio releases the **PTT** button, indicating the channel is free for you to respond. Press the **PTT** button to respond to the call.
-  If the Transmit Interrupt Remote Dekey feature is enabled, press the **PTT** button to stop an ongoing interruptible call and free the channel for you to respond.

The green LED lights up.

2 Wait for the Talk Permit Tone to end and speak clearly into the microphone if enabled.

3 Release the **PTT** button to listen.

The call ends when there is no voice activity for a predetermined period.

All Calls

An All Call is a call from an individual radio to every radio on the channel. An All Call is used to make important announcements, requiring full attention from the user. The users on the channel cannot respond to an All Call.

Receiving All Calls

When you receive an All Call:

- A tone sounds.
- The green LED blinks.
- The display shows the **Group Call** icon at the top right corner.
- The first text line shows the caller alias ID.
- The second text line displays `All Call`.
- Your radio unmutes and the incoming call sounds through the speaker.

The radio returns to the screen before receiving the All Call when the call ends.

An All Call does not wait for a predetermined period before ending.

🔊 If the Channel Free Indication feature is enabled, you hear a short alert tone when the transmitting radio releases the **PTT** button, indicating the channel is free for you to use.

You cannot respond to an All Call.



NOTICE:

The radio stops receiving the All Call if you switch to a different channel while receiving the call. You are not able to continue with any menu navigation or editing until the end of an All Call.

Making All Calls

Your radio must be programmed for you to make an All Call. Follow the procedure to make All Calls on your radio.

- 1 Select a channel with the active All Call group alias or ID.

- 2 Press the **PTT** button to make the call.

The green LED lights up. The display shows the **Group Call** icon and All Call.

- 3 Do one of the following:

- Wait for the Talk Permit Tone to end and speak clearly into the microphone if enabled.
- 📞 Wait for the **PTT** Sidetone to end and speak clearly into the microphone if enabled.

Users on the channel cannot respond to an All Call.

Making All Calls by Using the Programmable Number Key 📞

Follow the procedure to make All Calls on your radio by using the programmable number key.

- 1 Long press the programmed number key assigned to the predefined alias or ID when you are on the Home screen.

If a number key is assigned to an entry in a particular mode, this feature is not supported when you long press the number key in another mode.

A negative indicator tone sounds if the number key is not associated to an entry.

- 2 Press the **PTT** button to make the call.

The green LED lights up.

- 3 Release the **PTT** button to listen.

The green LED lights up when the target radio responds. You cannot respond to an All Call at the moment.

- 4  If the Channel Free Indication feature is enabled, you hear a short alert tone the moment the transmitting radio releases the **PTT** button, indicating the channel is free for you to respond. Press the **PTT** button to respond to the call.

The call ends when there is no voice activity for a predetermined period. The radio returns to the screen you were on prior to initiating the call. For a Private Call, you hear a short tone when the call ends.

See [Assigning Entries to Programmable Number Keys on page 394](#) for more information.

Selective Calls

A Selective Call is a call from an individual radio to another individual radio. It is a Private Call on an analog system.

Making Selective Calls

Your radio must be programmed for you to initiate a Selective Call. Follow the procedure to make Selective Calls on your radio.

- 1 Select a channel with the active subscriber alias or ID.
-

- 2 Press the **PTT** button to make the call.

The green LED lights up. The display shows the **Private Call** icon, the subscriber alias, and call status.

- 3 Do one of the following:

- Wait for the Talk Permit Tone to end and speak clearly into the microphone if enabled.
 -  Wait for the **PTT** Sidetone to end and speak clearly into the microphone if enabled.
-

- 4 Release the **PTT** button to listen.

The green LED lights up when the target radio responds.

- 5  If the Channel Free Indication feature is enabled, you hear a short alert tone the moment the transmitting radio releases the **PTT** button, indicating the channel is free for you to respond. Press the **PTT** button to respond to the call.

The call ends when there is no voice activity for a predetermined period.

- 6 The display shows `Call Ended`.
-

Responding to Selective Calls

Follow the procedure to respond to Selective Calls on your radio.

When you receive a Selective Call:

- The green LED blinks.
- The first text line shows the **Private Call** icon and the caller alias or `Selective Call` or `Alert with Call`.

- Your radio unmutes and the incoming call sounds through the speaker.

- 1 Press the **PTT** button to respond to the call.
The green LED lights up.
-

- 2 Wait for the Talk Permit Tone to end and speak clearly into the microphone if enabled.
-

- 3 Release the **PTT** button to listen.

The call ends when there is no voice activity for a predetermined period. A tone sounds. The display shows `Call Ended`.

Phone Calls

A Phone Call is a call from an individual radio to a telephone.

If Phone Call capability is not enabled in your radio:

- The display shows `Unavailable`.
- Your radio mutes the call.
- Your radio returns to the previous screen when the call ends.

During the Phone Call, your radio attempts to end the call when:

- You press the **One Touch Access** button with the deaccess code preconfigured.
- You enter the deaccess code as the input for extra digits.

During channel access, access or deaccess code, or extra digits transmission, your radio responds to the **On/Off**, **Volume Control**, and **Channel Selector** buttons or knobs only. A tone sounds for every invalid input.

During channel access, press  to dismiss the call attempt. A tone sounds.



NOTICE:

The access or deaccess code cannot be more than 10 characters.

Check with your dealer or system administrator for more information.

Making Phone Calls

Follow the procedure to make Phone Calls on your radio.

- 1 Press the programmed **One Touch Access** button to the predefined alias or ID.

If the entry for the **One Touch Access** button is empty, a negative indicator tone sounds. If the access code is not preconfigured in the Contact List, the display shows `Access Code:`.

- 2 Enter the access code, and press  to proceed.

The access or deaccess code cannot be more than 10 characters.

- 3 Press the **PTT** button to respond to the call. Release the **PTT** button to listen.
-

- 4 Enter extra digits with the keypad if requested by the call, and press  to proceed.

If the call ends while you are entering the extra digits requested by the call, your radio returns to the screen you were on before initiating the call.

The Dual Tone Multi Frequency (DTMF) Tone sounds. Your radio returns to the previous screen.

5 Press  to end the call.

6 Do one of the following:

- If the deaccess code was not preconfigured, enter the deaccess code when the display shows

De-Access Code:, and press  to proceed. The radio returns to the previous screen.

- Press the programmed **One Touch Access** button. If the entry for the **One Touch Access** button is empty, a negative indicator tone sounds.

The DTMF Tone sounds and the display shows

Ending Phone Call.

If the call ends successfully:



- A tone sounds.
- The display shows `Call Ended`.

If the call fails to end, the radio returns to the Phone Call screen. Repeat the last two steps or wait for the telephone user to end the call.



Making Phone Calls by Using the Contacts List

Follow the procedure to make Phone Calls on your radio by using the Contacts list.

1 Press  to access the menu.

2 Press  or  to `Contacts`. Press  to select.

The display shows the entries in alphabetical order.

3 Press  or  to the required alias or ID.



Press  to select.

When you press the **PTT** button while on the Phone Contacts screen:

- The first line of the display shows `Phone Number:.`
- The second line of the display shows a blinking cursor.

If the selected entry is empty:

- A negative indicator tone sounds.
- The display shows Phone Call Invalid #.

- 4 Press  or  to Call Phone. Press  to select.

The display shows Access Code: if the access code was not preconfigured.

- 5 Enter the access code, and press  to proceed.

The access or deaccess code cannot be more than 10 characters.

The first text line shows Calling. The second text line shows the subscriber alias or ID, and the **Phone Call** icon.

If the call is successful:

- The DTMF Tone sounds.
- You hear the dialing tone of the telephone user.
- The first text line shows the subscriber alias or ID, and the **RSSI** icon.
- The second text line shows Phone Call, and the **Phone Call** icon.

If the call is unsuccessful:

- A tone sounds.
- The display shows Phone Call Failed and then, Access Code:.
- Your radio returns to the screen you were on prior to initiating the call if the access code has been preconfigured in the Contacts list.

- 6 Press the **PTT** button to respond to the call.
The **RSSI** icon disappears.

- 7 Release the **PTT** button to listen.

- 8 Enter extra digits with the keypad if requested by the call, and press  to proceed.

If the call ends while you are entering the extra digits requested by the call, your radio returns to the screen you were on prior to initiating the call.

The DTMF Tone sounds. Your radio returns to the previous screen.

9 Press  to end the call.

10 If the deaccess code was not preconfigured, enter the deaccess code when the display shows De-

Access Code:, and press  to proceed.

The radio returns to the previous screen. The DTMF Tone sounds and the display shows Ending Phone Call.

If the call ends successfully:

- A tone sounds.
- The display shows Call Ended.

If the call fails to end, the radio returns to the Phone Call screen. Repeat [step 9](#) and [step 10](#), or wait for the telephone user to end the call. When you press the **PTT** button while in the Phone Contacts screen, as tone sounds and the display shows Press OK to Place Phone Call.

When the telephone user ends the call, a tone sounds and the display shows Phone Call Ended.

If the call ends while you are entering the extra digits requested by the Phone Call, your radio returns to the screen you were on prior to initiating the call.



NOTICE:

During the channel access, press  to dismiss the call attempt and a tone sounds.



During the call, when you press **One Touch Access** button with the deaccess code preconfigured or enter the deaccess code as the input for extra digits, your radio attempts to end the call.



During channel access and access/ deaccess code or extra digits transmission, your radio responds to **On/Off** button, **Volume Knob**, and **Channel Rocker** only. A tone sounds for every invalid input.



Making Phone Calls by Using the Manual Dial

Follow the procedure to make Phone Calls on your radio by using the manual dial.

- 1 Press  to access the menu.

- 2 Press  or  to `Contacts`. Press  to select.

- 3 Press  or  to `Manual Dial`. Press  to select.

- 4 Press  or  to `Phone Number`. Press  to select.
The display shows `Number:` and a blinking cursor.

- 5 Enter the telephone number, and press  to proceed.

The display shows `Access Code:` and a blinking cursor if the access code was not preconfigured.

- 6 Enter the access code, and press  to proceed.

The access or deaccess code cannot be more than 10 characters.

- 7 The green LED lights up. The display shows the **Phone Call** icon at the top right corner. The first text line shows the subscriber alias. The second text line shows the call status.

If the call is successful:

- The DTMF Tone sounds.
- You hear the dialing tone of the telephone user.
- The first text line shows the subscriber alias.
- The display continues to show the **Phone Call** icon at the top right corner.

If the call is unsuccessful:

- A tone sounds.

- The display shows `Phone Call Failed` and then, `Access Code:`.
- Your radio returns to the screen you were on before initiating the call if the access code has been preconfigured in the Contacts list.

If the call fails to end, the radio returns to the Phone Call screen. Repeat [step 8](#), or wait for the telephone user to end the call.

8 Press  to end the call.

9 Do one of the following:

- If the deaccess code was not preconfigured, enter the deaccess code when the display shows `De-Access Code:`, and press  to proceed. The radio returns to the previous screen.
- Press the programmed **One Touch Access** button.
If the entry for the **One Touch Access** button is empty, a negative indicator tone sounds.

The DTMF Tone sounds and the display shows `Ending Phone Call`.

If the call ends successfully:

- A tone sounds.
- The display shows `Call Ended`.

**NOTICE:**

When you press **PTT** button while in the Phone Contacts screen, a tone sounds and the display shows `Press OK to Place Phone Call`.

When the telephone user ends the call, a tone sounds and the display shows `Call Ended`.

If the call ends while you are entering the extra digits requested by the Phone Call, your radio returns to the screen you were on before initiating the call.

During the channel access, press  to dismiss the call attempt and a tone sounds.

During the call, when you press **One Touch Access** button with the deaccess code preconfigured or enter the deaccess code as the input for extra digits, your radio attempts to end the call.



During channel access and access/deaccess code or extra digits transmission, you radio responds to **On/Off** button, **Volume Knob**,



and **Channel Rocker** only. A tone sounds for every invalid input.









Making Group, Private, Phone or All Calls by Using the Alias Search

Follow the procedure to make any calls by using the alias search.

- 1 Press  to access the menu.

- 2 Press  or  to `Contacts`. Press  to select.
The display shows the entries in alphabetical order.

- 3 Press  or  to the required subscriber alias or ID. The first line of the display shows `Phone Number:`. The second line of the display shows a blinking cursor. Use the keypad to enter a telephone number.



- 4 Press  to select. If the entry selected is empty, a negative indicator tone sounds and the display shows `Phone Call Invalid #`.
-
- 5 Press  or  to Call Phone and Press  to select. If the access code was not preconfigured in the Contacts list, the first line of the display shows `Access Code:`. The second line of the display shows a blinking cursor. Enter the access code and press the  button to proceed. If successful, the DTMF tone sounds. You hear the dialing tone of the telephone user. The first line of the display shows the subscriber alias or ID, and the RSSI icon. The second line of the display shows `Phone Call` and the Phone Call icon. If unsuccessful, a tone sounds and the display shows `Phone Call Failed`. Your radio returns to the Access Code input screen. If the access code was preconfigured in the Contacts list, the radio returns to the screen you were on prior to initiating the call.
-
- 6 Press the **PTT** button to talk and release it to listen. The RSSI icon disappears during transmission.
-
- 7 To enter extra digits, if requested by the Phone Call, do one of the following.
- Press any keypad key to begin the input of the extra digits. The first line of the display shows `Extra Digits:`. The second line of the display shows a blinking cursor. Enter the extra digits and press the  button to proceed. The DTMF tone sounds and the radio returns to the previous screen.
 - Press **One Touch Access** button. The DTMF tone sounds. If the entry for the **One Touch Access** button is empty, a negative indicator tone sounds.
-
- 8 Press  to end the call. If deaccess code was not preconfigured in the Contacts list, the first line of the display shows `De-Access Code:`. The second line of the display shows a blinking cursor. Enter the deaccess code and press  to proceed. The radio returns to the previous screen. The DTMF tone sounds and the display shows `Ending Phone Call`. If successful, a tone sounds and the display shows `Phone Call Ended`. Your radio returns to the Phone

Call screen. If unsuccessful, your radio returns to the Phone Call screen. When you press the **PTT** button while in the Phone Contacts screen, a tone sounds and the display shows **Press OK to Place Phone Call**. When the telephone user ends the call, a tone sounds and the display shows **Phone Call Ended**. If the call ends while you are entering the extra digits requested by the Phone Call, your radio returns to the screen you were on prior to initiating the call.



NOTICE:

During the channel access, press  to dismiss the call attempt and a tone sounds button or to exit

alias search. Press  or  to exit alias search. During the call, when you press the **One Touch Access** button with the deaccess code preconfigured or enter the deaccess code as the input for extra digits, your radio attempts to end the call. During channel access and access/ deaccess code or extra digits transmission, your radio responds to On/Off button, Volume Knob, and Channel Rocker only. A tone sounds for every invalid input.



Dual Tone Multi Frequency

The Dual Tone Multi Frequency (DTMF) feature allows the radio to operate in a radio system with an interface to the telephone systems.

You can turn off the DTMF tone by disabling all radio tones and alerts. See [Turning Radio Tones/Alerts On or Off on page 194](#) for more information.

Initiating DTMF Calls

Follow the procedure to initiate DTMF calls on your radio.

- 1 Press and hold the **PTT** button.
-
- 2 Do one of the following:
 - Enter the desired number to initiate a DTMF call.
 - Press  to initiate a DTMF call.
 - Press  to initiate a DTMF call.
-

Responding to Phone Calls as Group Calls

Follow the procedure to respond to Phone Calls as Group Calls on your radio.

When you receive a Phone Call as a Group Call:

- The display shows the **Phone Call** icon at the top right corner.
- The display shows the group alias and Phone Call.

If Phone Call capability is not enabled on your radio, the first line of the display shows `Unavailable` and your radio mutes the call. Your radio returns to the previous screen when the call ends.

- 1 Press the **PTT** button to respond to the call. Release the **PTT** button to listen.

- 2 Press  to end the call.

The display shows `Ending Phone Call`.

If the call ends successfully:

- A tone sounds.
- The display shows `Call Ended`.

If the call fails to end, the radio returns to the Phone Call screen. Repeat this step or wait for the telephone user to end the call.

Responding to Phone Calls as All Calls

When you receive a Phone Call as an All Call, you can respond to or end the call, only if an All Call type is assigned to the channel. Follow the procedure to respond to Phone Calls as All Calls on your radio.

When you receive a Phone Call as an All Call:

- The display shows the **Phone Call** icon at the top right corner.
- The display shows `All Call` and Phone Call.

If Phone Call capability is not enabled on your radio, the first line of the display shows `Unavailable` and your radio mutes the call.

Your radio returns to the previous screen when the call ends.

- 1 Press the **PTT** button to respond to the call.
-

2 Release the **PTT** button to listen.

3 Press  to end the call.

The display shows `Ending Phone Call`.

If the call ends successfully:

- A tone sounds.
- The display shows `All Call` and `Call Ended`.

If the call fails to end, the radio returns to the Phone Call screen. Repeat [step 3](#) or wait for the telephone user to end the call.

Responding to Phone Calls as Private Calls

Follow the procedure to respond to Phone Calls as Private Calls on your radio.

When you receive a Phone Call as a Private Call:

- The display shows the **Phone Call** icon at the top right corner.
- The display shows the caller alias or `Phone Call`.

If Phone Call capability is not enabled on your radio, the first line of the display shows `Unavailable` and your radio mutes the call. Your radio returns to the previous screen when the call ends.

1 Press the **PTT** button to respond to the call. Release the **PTT** button to listen.

2 Press  to end the call.

The display shows `Ending Phone Call`.

If the call ends successfully:

- A tone sounds.
- The display shows `Call Ended`.

If the call fails to end, the radio returns to the Phone Call screen. Repeat this step or wait for the telephone user to end the call.

Stopping Radio Calls

This feature allows you to stop an ongoing Group or Private Call to free the channel for transmission. For example, when a radio experiences a "stuck microphone" condition where the **PTT** button is inadvertently pressed by the user.

Your radio must be programmed to allow you to use this feature. Follow the procedure to stop calls on your radio.

- 1 Press the programmed **Transmit Interrupt Remote Dekey** button.

The display shows `Remote Dekey`.

- 2 Wait for acknowledgment.

If successful:

- A positive indicator tone sounds.
- The display shows `Remote Dekey Success`.

If unsuccessful:

- A negative indicator tone sounds.
 - The display shows `Remote Dekey Failed`.
-



NOTICE:

Check with your dealer or system administrator for more information.

Talkaround

This feature allows you to continue communication when your repeater is not operational, or when your radio is out of range from the repeater but within talking range of other radios.

The talkaround setting is retained even after powering down.







NOTICE:



This feature is not applicable in Capacity Plus–Single-Site, Capacity Plus–Multi-Site, and Citizens Band channels that are in the same frequency.



Toggling Between Repeater and Talkaround Modes

Follow the procedure to toggle between Repeater and Talkaround modes on your radio.

- 1 Do one of the following:
 - Press the programmed **Repeater/Talkaround** button. Skip the following steps.
 - Press  **OK** to access the menu.
-

2 Press  or  to Utilities. Press  to select.

3 Press  or  to Radio Settings. Press  to select.

4 Press  or  to Talkaround. Press  to select.

If enabled,  appears beside Enabled.

If disabled,  disappears beside Enabled.

The screen automatically returns to the previous screen.

Broadcast Voice Calls

A Broadcast Voice Call is a one-way voice call from any user to an entire talkgroup.

The Broadcast Voice Call feature allows only the call initiating user to transmit to the talkgroup, while the recipients of the call cannot respond (no Call Hang Time).

Your radio must be programmed to allow you to use this feature. Check with your dealer or system administrator for more information.

Making Broadcast Voice Calls

Program your radio to make Broadcast Voice Calls.

1 Select a channel with the active group alias or ID.

2 Press the **PTT** button to make the call.

The green LED lights up. The display shows Broadcast Call, the **Group Call** icon and alias.

3 Do one of the following:

- Wait for the Talk Permit Tone to end and speak clearly into the microphone if enabled.
- Wait for the **PTT** Sidetone to end and speak clearly into the microphone if enabled.



NOTICE:

Users on the channel cannot respond to Broadcast Voice Calls.

The radio returns to the previous menu after the call ends.

Making Broadcast Voice Calls by Using the Programmable Number Key

Follow the procedure to make Broadcast Voice Call on your radio by using the programmable number key.

- 1 On the **Home** screen, long press the programmed number key assigned to the predefined alias or ID.

If the number key is assigned to an entry in a particular mode, this feature is not supported when you long press the number key in another mode.

If the number key is not associated to an entry, a negative indicator tone sounds

-
- 2 Press the **PTT** button to make the call.



The green LED lights up.

See [Assigning Entries to Programmable Number Keys on page 394](#) for more information.



Making Broadcast Voice Calls by Using the Alias Search

Follow the procedure to make Broadcast Voice Call on your radio by using the alias search.



- 1 Press  to access the menu.

-
- 2 Press  or  to `Contacts`. Press  to select.

The display shows the entries in alphabetical order.

-
- 3 Press  or  to the required subscriber alias or ID. The first line of the display shows `Phone Number:`. The second line of the display shows a blinking cursor. Use the keypad to enter a telephone number.

-
- 4 Press  to select. If the entry selected is empty, a negative indicator tone sounds and the display shows `Phone Call Invalid #`.
-

- 5 Press  or  to Call Phone and Press  to select. If the access code was not preconfigured in the Contacts list, the first line of the display shows `Access Code:`. The second line of the display shows a blinking cursor. Enter the access code and

press the  button to proceed. If successful, the DTMF tone sounds. You hear the dialing tone of the telephone user. The first line of the display shows the subscriber alias or ID, and the RSSI icon. The second line of the display shows `Phone Call` and the Phone Call icon. If unsuccessful, a tone sounds and the display shows `Phone Call Failed`. Your radio returns to the Access Code input screen. If the access code was preconfigured in the Contacts list, the radio returns to the screen you were on prior to initiating the call.



-
- 6 Press the **PTT** button to talk and release it to listen. The RSSI icon disappears during transmission.

-
- 7 To enter extra digits, if requested by the Phone Call, do one of the following.
- Press any keypad key to begin the input of the extra digits. The first line of the display shows

`Extra Digits:`. The second line of the display shows a blinking cursor. Enter the extra digits

and press the  button to proceed. The DTMF tone sounds and the radio returns to the previous screen.

- Press **One Touch Access** button. The DTMF tone sounds. If the entry for the **One Touch Access** button is empty, a negative indicator tone sounds.



-
- 8 Press  to end the call. If deaccess code was not preconfigured in the Contacts list, the first line of the display shows `De-Access Code:`. The second line of the display shows a blinking cursor. Enter the deaccess code and press  to proceed. The radio returns to the previous screen. The DTMF tone sounds and the display shows `Ending Phone Call`. If successful, a tone sounds and the display shows `Phone Call Ended`. Your radio returns to the Phone Call screen. If unsuccessful, your radio returns to the Phone Call screen. When you press the **PTT** button while in the Phone Contacts screen, as tone sounds and the display shows `Press OK to Place Phone Call`. When the telephone user ends the call, a tone

sounds and the display shows **Phone Call Ended**. If the call ends while you are entering the extra digits requested by the Phone Call, your radio returns to the screen you were on prior to initiating the call.



NOTICE:

During the channel access, press  to dismiss the call attempt and a tone sounds button or to exit

alias search. Press  button or  to exit alias search. During the call, when you press One Touch Access button with the deaccess code preconfigured or enter the deaccess code as the input for extra digits, your radio attempts to end the call. During channel access and access/deaccess code or extra digits transmission, you radio responds to On/Off button, Volume Knob, and Channel Rocker only. A tone sounds for every invalid input.

- The display shows the **Group Call** icon at the top right corner.
- The first text line shows the caller alias ID.
- The second text line displays **Broadcast Call**.
- Your radio unmutes and the incoming call sounds through the speaker.

When the call ends, the radio returns to the previous screen.

A Broadcast Voice Call does not wait for a predetermined period before ending.

You cannot respond to a Broadcast Voice Call.



NOTICE:

The radio stops receiving the Broadcast Voice Call if you switch to a different channel while receiving the call. You cannot continue with any menu navigation or editing until the end of the Broadcast Voice Call.

Receiving Broadcast Voice Calls

When you receive a Broadcast Voice Call:

- A tone sounds.
- The green LED blinks.

Unaddressed Calls

An Unaddressed Call is a group call to one of the 16 predefined group IDs.

This feature is configured using CPS-RM. A contact for one of the predefined IDs is required to initiate and/or receive

an Unaddressed Call. Check with your dealer or system administrator for more information.

Making Unaddressed Calls

1 Select a channel with the active group alias or ID.

2 Press the **PTT** button to make the call.

The green LED lights up. The text line shows Unaddressed Call, the **Group Call** icon and alias.

3 Do one of the following:

- Wait for the Talk Permit Tone to end and speak clearly into the microphone if enabled.
 - Wait for the **PTT** Sidetone to end and speak clearly into the microphone if enabled.
-

4 Release the **PTT** button to listen.

The green LED lights up when the target radio responds. A momentary tone sounds. The display shows Unaddressed Call, the **Group Call** icon, and alias or ID, and the transmitting radio alias or ID.

5 If the Channel Free Indication feature is enabled, you hear a short alert tone the moment the transmitting radio releases the **PTT** button, indicating that the channel is free for you to respond. Press the **PTT** button to respond to the call.

The call ends when there is no voice activity for a predetermined period.

The call initiator can press  to end a Group Call.

Responding to Unaddressed Calls

When you receive an Unaddressed Call:

- The green LED blinks.
- A momentary tone sounds.
- The text line shows Unaddressed Call, the caller alias, and the group call alias.
- Your radio unmutes and the incoming call sounds through the speaker.

1 Do one of the following:

- If the Channel Free Indication feature is enabled, you hear a short alert tone the moment the transmitting radio releases the **PTT** button,

indicating the channel is free for you to respond. Press the **PTT** button to respond to the call.

- If the Voice Interrupt feature is enabled, press the **PTT** button to interrupt the audio from the transmitting radio and free the channel for you to respond.

The green LED lights up.

2 Do one of the following:

- Wait for the Talk Permit Tone to end and speak clearly into the microphone if enabled.
 - Wait for the **PTT** Sidetone to end and speak clearly into the microphone if enabled.
-

3 Release the **PTT** button to listen.

The call ends when there is no voice activity for a predetermined period.

Open Voice Channel Mode (OVCM)

An Open Voice Channel Mode (OVCM) allows a radio that is not preconfigured to work in a particular system to both receive and transmit during a group or individual call.

The OVCM group call also supports broadcast calls. Program your radio to use this feature. Check with your dealer or system administrator for more information.

Making OVCM Calls

Your radio must be programmed for you to make an OVCM Call. Follow the procedure to make OVCM Calls on your radio.

1 Press the **PTT** button to make the call.

The green LED lights up.

The text line shows the call type icon, **OVCM** and alias, indicating that the radio has entered OVCM State.

2 Do one of the following:

- Wait for the Talk Permit Tone to end and speak clearly into the microphone if enabled.
 - Wait for the **PTT** Sidetone to end and speak clearly into the microphone if enabled.
-

Responding to OVCM Calls

When you receive an OVCM Call:

- The green LED blinks.
 - The text line shows the call type icon, OVCM, and alias.
 - Your radio unmutes and the incoming call sounds through the speaker.
- 1 Do one of the following:
 - If the Channel Free Indication feature is enabled, you hear a short alert tone the moment the transmitting radio releases the **PTT** button, indicating the channel is free for you to respond. Press the **PTT** button to respond to the call.
 - If the Voice Interrupt feature is enabled, press the **PTT** button to interrupt the audio from the transmitting radio and free the channel for you to respond.

The green LED lights up.

-
- 2 Do one of the following:
 - Wait for the Talk Permit Tone to end and speak clearly into the microphone if enabled.

- Wait for the **PTT** Sidetone to end and speak clearly into the microphone if enabled.

-
- 3 Release the **PTT** button to listen.

The call ends when there is no voice activity for a predetermined period.

Advanced Features

This chapter explains the operations of the features available in your radio.

Your dealer or system administrator may have customized your radio for your specific needs. Check with your dealer or system administrator for more information.

Home Channel Reminder

This feature provides a reminder when the radio is not set to the home channel for a period of time.

If this feature is enabled through CPS, when your radio is not set to the home channel for a period of time, the following occurs periodically:

- The Home Channel Reminder tone and announcement sound.

- The first line of the display shows `Non.`
- The second line shows `Home Channel.`

You can respond to the reminder by performing one of the following actions:

- Return to the home channel.
- Mute the reminder temporarily using the programmable button.
- Set a new home channel using the programmable button.

Muting the Home Channel Reminder

When the Home Channel Reminder sounds, you can temporarily mute the reminder.



Press the **Silence Home Channel Reminder** programmable button.



The first line of the display shows `HCR` and the second line shows `Silenced.`



Setting New Home Channels





When the Home Channel Reminder occurs, you can set a new home channel.

- 1 Do one of the following:
 - Press the **Reset Home Channel** programmable button to set the current channel as the new Home Channel. Skip the following steps. The first line of the display shows the channel alias and the second line shows `New Home Ch.`
 - Press  to access the menu.
-

- 2 Press  or  to `Utilities`. Press  to select.
-

- 3 Press  or  to `Radio Settings`. Press  to select.
-

- 4 Press  or  to `Home Channel`. Press  to select.
-

- 5 Press  or  to the desired new home channel alias. Press  to select.
- The display shows  beside the selected home channel alias.
-



Radio Check

This feature allows you to determine if another radio is active in a system without disturbing the radio user. No audible or visual notification is shown on the target radio. This feature is only applicable for subscriber aliases or IDs. Your radio must be programmed to allow you to use this feature.

Sending Radio Checks

Follow the procedure to send radio checks on your radio.

- 1 Press the programmed **Radio Check** button.
-

- 2 Press  or  to the required alias or ID. Press  to select.
- The display shows a transitional mini notice, indicating the request is in progress. The green LED lights up.
-

Wait for acknowledgment.

If you press  when the radio is waiting for acknowledgment, a tone sounds, the radio terminates all retries, and exits Radio Check mode.

If successful:

- A positive indicator tone sounds.
- The display shows a positive mini notice.

If unsuccessful:



- A negative indicator tone sounds.
- The display shows a negative mini notice.



The radio returns to the subscriber alias or ID screen.



Sending Radio Checks by Using the Manual Dial

Follow the procedure to send radio checks on your radio by using the manual dial.

- 1 Press  to access the menu.

- 2 Press  or  to **Contacts**. Press  to select.

- 3 Press  or  to **Manual Dial**. Press  to select.

- 4 Press  or  to **Radio Number**. Press  to select.

- 5 Do one of the following:
 - Enter the subscriber alias or ID, and press  to proceed.

- Edit the previously dialed ID, and press  to proceed.

- 6 Press  or  to **Radio Check**. Press  to select.

The display shows a transitional mini notice, indicating the request is in progress. The green LED lights up.

- 7 Wait for acknowledgment.

If you press  when the radio is waiting for acknowledgement, a tone sounds, the radio terminates all retries, and exits Radio Check mode.

If successful:

- A positive indicator tone sounds.
- The display shows a positive mini notice.

If unsuccessful:

- A negative indicator tone sounds.
- The display shows a negative mini notice.

The radio returns to the subscriber alias or ID screen.

This feature stops after a programmed duration or when there is any user operation on the target radio.

Remote Monitor

This feature is used to turn on the microphone of a target radio with a subscriber alias or ID. You can use this feature to remotely monitor any audible activity surrounding the target radio.

There are two types of Remote Monitor:

- Remote Monitor without Authentication
- Remote Monitor with Authentication.

Authenticated Remote Monitor is a purchasable feature. In Authenticated Remote Monitor, verification is required when your radio turns on the microphone of a target radio.



When your radio initiates this feature on a target radio with User Authentication, a passphrase is required. The passphrase is preprogrammed into the target radio through CPS.

Both your radio and the target radio must be programmed to allow you to use this feature.

Initiating Remote Monitor

Follow the procedure to initiate Remote Monitor on your radio.

1 Press the programmed **Remote Monitor** button.

2 Press  or  to the required alias or ID.

3 Press  to select. One of the following scenarios occurs:

- The display shows a transitional mini notice, indicating the request is in progress. The green LED lights up.
- A passphrase screen appears.

Enter the passphrase. Press  to proceed.

- If the passphrase is correct, the display shows a transitional mini notice, indicating the request is in progress. The green LED lights up.

- If the passphrase is incorrect, the display shows a negative mini notice, and returns to the previous screen.

4 Wait for acknowledgment.

If successful:

- A positive indicator tone sounds.
- The display shows a positive mini notice.
- The audio from the monitored radio starts playing for a programmed duration, and the display shows *Rem. Monitor*. Once the timer expires, an alert tone sounds, and the LED turns off.



If unsuccessful:



- A negative indicator tone sounds.
- The display shows a negative mini notice.

Initiating Remote Monitor by Using the Contacts List

Follow the procedure to initiate Remote Monitor on your radio by using the Contacts list.

1 Press  to access the menu.

2 Press  or  to *Contacts*. Press  to select.

3 Press  or  to the required alias or ID. Press  to select.

4 Press  or  to *Remote Mon..*

5 Press  to select. One of the following scenarios occurs:

- The display shows a transitional mini notice, indicating the request is in progress. The green LED lights up.
- A passphrase screen appears.

Enter the passphrase. Press  to proceed.

- If the passphrase is correct, the display shows a transitional mini notice, indicating the

request is in progress. The green LED lights up.

- If the passphrase is incorrect, the display shows a negative mini notice, and returns to the previous screen.

6 Wait for acknowledgment.

If successful:

- A positive indicator tone sounds.
- The display shows a positive mini notice.
- The audio from the monitored radio starts playing for a programmed duration, and the display shows *Rem. Monitor*. Once the timer expires, an alert tone sounds, and the LED turns off.



If unsuccessful:



- A negative indicator tone sounds.
 - The display shows a negative mini notice.
-



Initiating Remote Monitor by Using the Manual Dial

Follow the procedure to initiate Remote Monitor on your radio by using the manual dial.

- 1 Press  to access the menu.

- 2 Press  or  to *Contacts*. Press  to select.

- 3 Press  or  to *Manual Dial*. Press  to select.

- 4 Press  or  to *Radio Number*. Press  to select.

- 5 Do one of the following:
 - Enter the subscriber alias or ID, and press  to proceed.

- Edit the previously dialed ID, and press  to proceed.
-

6 Press  or  to Remote Mon..

7 Press  to select. One of the following scenarios occurs:

- The display shows a transitional mini notice, indicating the request is in progress. The green LED lights up.
- A passphrase screen appears.

Enter the passphrase. Press  to proceed.

- If the passphrase is correct, the display shows a transitional mini notice, indicating the request is in progress. The green LED lights up.
 - If the passphrase is incorrect, the display shows a negative mini notice, and returns to the previous screen.
-

8 Wait for acknowledgment.

If successful:

- A positive indicator tone sounds.
- The display shows a positive mini notice.
- The audio from the monitored radio starts playing for a programmed duration, and the display shows Rem. Monitor. Once the timer expires, an alert tone sounds, and the LED turns off.

If unsuccessful:

- A negative indicator tone sounds.
 - The display shows a negative mini notice.
-

Scan Lists

Scan lists are created and assigned to individual channels or groups. Your radio scans for voice activity by cycling through the channel or group sequence specified in the scan list for the current channel or group.

Your radio can support up to 250 scan lists, with a maximum of 16 members in a list.

Each scan list supports a mixture of both analog and digital entries.

You can add, delete, or prioritize channels by editing a scan list.

You can attach a new scan list to your radio by using Front Panel Programming. See [Front Panel Configuration on page 183](#) for more information.

The **Priority** icon appears on the left of the member alias, if set, to indicate whether the member is on a Priority 1 or Priority 2 channel list. You cannot have multiple Priority 1 or Priority 2 channels in a scan list. There is no **Priority** icon if priority is set to **None**.







NOTICE:



This feature is not applicable in Capacity Plus.



Viewing Entries in the Scan List

Follow the procedure to view the entries in the Scan list on your radio.

- 1 Press  to access the menu.

- 2 Press  or  to Scan. Press  to select.



- 3 Press  or  to Scan List. Press  to select.



- 4 Press  or  to view each member on the list.

Viewing Entries in the Scan List by Using the Alias Search

Follow the procedure to view entries in the Scan list on your radio by using the alias search.

- 1 Press  to access the menu.

- 2 Press  or  to Scan. Press  to select.

- 3 Press  or  to Scan List. Press  to select.

- 4 Enter the first character of the required alias.
The display shows a blinking cursor.

- 5 Enter the rest of the characters of the required alias.



The alias search is case-insensitive. If there are two or more entries with the same name, the display shows the entry listed first in the list.



The first text line shows the characters you entered. The following text lines show the shortlisted search results.



Adding New Entries to the Scan List



Follow the procedure to add new entries to the Scan list on your radio.



- 1 Press  to access the menu.

- 2 Press  or  to Scan. Press  to select.







- 3 Press  or  to Scan List. Press  to select.

- 4 Press  or  to Add Member. Press  to select.

- 5 Press  or  to the required alias or ID.
Press  to select.

- 6 Press  or  to the required priority level.
Press  to select.



The display shows a positive mini notice and then, Add Another?.



- 7 Do one of the following:
 - Press  or  to Yes to add another entry.
Press  to select. Repeat [step 5](#) and [step 6](#).
 - Press  or  to No to save the current list.
Press  to select.



Adding New Entries to the Scan List by Using the Alias Search

Follow the procedure to add new entries to the Scan list on your radio by using the alias search.

- 1 Press  to access the menu.

- 2 Press  or  to Scan. Press  to select.

- 3 Press  or  to Scan List. Press  to select.

- 4 Press  or  to Add Member. Press  to select.



- 5 Enter the first character of the required alias.
The display shows a blinking cursor.



- 6 Enter the rest of the characters of the required alias.



The alias search is case-insensitive. If there are two or more entries with the same name, the display shows the entry listed first in the list.

The first text line shows the characters you entered. The following text lines show the shortlisted search results.

-
- 7 Press  to select.

 - 8 Press  or  to the required priority level.
Press  to select.
The display shows a positive mini notice and then, Add Another?.



 - 9 Do one of the following:
 - Press  or  to Yes to add another entry.
Press  to select. Repeat Step [step 5](#) to Step [step 8](#).



- Press  or  to No to save the current list.
Press  to select.
-



Deleting Entries from the Scan List



Follow the procedure to delete entries from the Scan list.

- 1 Press  to access the menu.







 - 2 Press  or  to Scan. Press  to select.

 - 3 Press  or  to Scan List. Press  to select.

 - 4 Press  or  to the required alias or ID.
Press  to select.

 - 5 Press  or  to Delete. Press  to select.
The display shows Delete Entry?.
-

6 Do one of the following:

- Press  or  to Yes to delete the entry.
Press  to select.
The display shows a positive mini notice.
 - Press  or  to No to return to the previous screen. Press  to select.
-



7 Repeat [step 4](#) to [step 6](#) to delete other entries.



8 Long press  to return to the Home screen after deleting all required aliases or IDs.



Setting Priority for Entries in the Scan List



Follow the procedure to set priorities for entries in the Scan list on your radio.



- 1 Press  to access the menu.
-

2 Press  or  to Scan. Press  to select.

3 Press  or  to Scan List. Press  to select.

4 Press  or  to the required alias or ID.
Press  to select.

5 Press  or  to Edit Priority. Press  to select.

6 Press  or  to the required priority level.
Press  to select.

The display shows a positive mini notice before returning to the previous screen. The **Priority** icon appears on the left of the member alias.

Scan

Your radio cycles through the programmed scan list for the current channel looking for voice activity when you start a scan.



NOTICE:

This feature is not applicable in Capacity Plus.

During a dual-mode scan, if you are on a digital channel, and your radio locks onto an analog channel, it automatically switches from digital mode to analog mode for the duration of the call. This is also true for the reverse.

There are two ways of initiating scan:

Main Channel Scan (Manual)

Your radio scans all the channels or groups in your scan list. On entering scan, your radio may, depending on the settings, automatically start on the last scanned active channel or group, or on the channel where scan was initiated.

Auto Scan (Automatic)

Your radio automatically starts scanning when you select a channel or group that has Auto Scan enabled.



**NOTICE:**



When you configure **Receive Group Message In Scan**, your radio is able to receive group messages from non-home channels. Your radio is able to reply the group messages on home channel but is not able to reply on non-home channels. Check with your dealer or system administrator for more information.



Turning Scan On or Off

Follow the procedure to turn scan on or off on your radio.

- 1 Press  **OK** to access the menu.

- 2 Press  or  to **Scan**. Press  **OK** to select.

- 3 Press  or  to **Scan State**. Press  **OK** to select.

- 4 Press  or  to the required scan state and press  **OK** to select.

If scan is enabled:

- The display shows **Scan On** and **Scan** icon.
- The yellow LED blinks.

If scan is disabled:

- The display shows **Scan Off**.
- The **Scan** icon disappears.
- The LED turns off.

Responding to Transmissions During Scanning

During scanning, your radio stops on a channel or group where activity is detected. The radio stays on that channel for a programmed duration known as hang time. Follow the procedure to respond to transmissions during scanning.

- 1  If the Channel Free Indication feature is enabled, you hear a short alert tone the moment the transmitting radio releases the **PTT** button, indicating the channel is free for you to respond. Press the **PTT** button during hang time.
The green LED lights up.

- 2 Release the **PTT** button to listen.

The radio returns to scanning other channels or groups if you do not respond within the hang time.

Deleting Nuisance Channels

If a channel continually generates unwanted calls or noise, (termed a "nuisance" channel), you can temporarily remove the unwanted channel from the scan list. This capability does not apply to the channel designated as the Selected Channel. Follow the procedure to delete nuisance channels on your radio.

- 1 When your radio locks on to an unwanted or nuisance channel, press the programmed **Nuisance Channel Delete** button until you hear a tone.
-

- 2 Release the programmed **Nuisance Channel Delete** button.

The nuisance channel is deleted.

Restoring Nuisance Channels

Follow the procedure to restore nuisance channels on your radio.

Do one of the following:

- Turn the radio off and then power it on again.
 - Stop and restart a scan using the programmed **Scan** button or menu.
 - Change the channel using the **Channel Up/Down** button.
-

Vote Scan

Vote Scan provides you with wide area coverage in areas where there are multiple base stations transmitting identical information on different analog channels.

Your radio scans analog channels of multiple base stations and performs a voting process to select the strongest received signal. Once that is established, your radio receives transmissions from that base station.

During a vote scan, the yellow LED blinks and the display shows the **Vote Scan** icon.

Follow the same procedures as [Responding to Transmissions During Scanning on page 390](#), to respond to a transmission during a vote scan.

Contacts Settings

Contacts provides address book capabilities on your radio. Each entry corresponds to an alias or ID that you use to initiate a call. The entries are alphabetically sorted.

Each entry, depending on context, associates with the different call types: Group Call, Private Call, All Call, PC Call, or Dispatch Call.

PC Call and Dispatch Call are data-related. They are only available with the applications. Refer to the data applications documentation for further details.

➊ Additionally, Contacts menu allows you to assign each entry to a programmable number key or more on a keypad microphone. If an entry is assigned to a number key, your radio can perform a quick dial on the entry.



NOTICE:

You see a checkmark before each number key that is assigned to an entry. If the checkmark is before Empty, you have not assign a number key to the entry.

Each entry within Contacts displays the following information:

- Call Type
- Call Alias

- Call ID







NOTICE:



If the Privacy feature is enabled on a channel, you can make privacy-enabled Group Calls, Private Calls, and All Calls on that channel. Only target radios with the same Privacy Key, or the same Key Value and Key ID as your radio will be able to decrypt the transmission.

Making Group Calls by Using the Contacts List

Follow the procedure to make Group Calls on your radio by using the Contacts list.

- 1 Press  to access the menu.

- 2 Press  or  to Contacts. Press  to select.

- 3 Press  or  to the required alias or ID. Press  to select.

- 4 Press the **PTT** button to make the call.

The green LED lights up.

- 5 Release the **PTT** button to listen.

The green LED blinks when any user in the group responds. The display shows the **Group Call** icon, and alias or ID, and the transmitting radio alias or ID.



- 6  If the Channel Free Indication feature is enabled, you hear a short alert tone the moment the transmitting radio releases the **PTT** button, indicating the channel is free for you to respond. Press the **PTT** button to respond to the call.



The call ends when there is no voice activity for a predetermined period.

Making Private Calls by Using the Contacts List

Follow the procedure to make Private Calls on your radio by using the Contacts list.

- 1 Press  to access the menu.
-

- 2 Press  or  to **Contacts**. Press  to select.
-

- 3 Press  or  to the required alias or ID. Press  to select.
-

- 4 Press the **PTT** button to make the call. The green LED lights up. The display shows the destination alias.
-

- 5 Wait for the Talk Permit Tone to end and speak clearly into the microphone if enabled.
-

- 6 Release the **PTT** button to listen. The green LED blinks when the target radio responds. The display shows the transmitting user alias or ID.
-

- 7  If the Channel Free Indication feature is enabled, you hear a short alert tone the moment the



transmitting radio releases the **PTT** button, indicating the channel is free for you to respond. Press the **PTT** button to respond to the call.



The call ends when there is no voice activity for a predetermined period. A tone sounds. The display shows `Call Ended`.

Assigning Entries to Programmable Number Keys







Follow the procedure to assign entries to programmable number keys on your radio.

- 1 Press  to access the menu.

- 2 Press  or  to `Contacts`. Press  to select.

- 3 Press  or  to the required alias or ID.
Press  to select.

- 4 Press  or  to `Program Key`. Press  to select.

- 5 Do one of the following:
 - If the desired number key has not been assigned to an entry, press  or  to the desired number key. Press  to select.
 - If the desired number key has been assigned to an entry, the display shows `The Key is Already Assigned` and then, the first text line shows `Overwrite?`. Do one of the following:
Press  or  to `Yes`. Press  to select.

The radio sounds a positive indicator tone and the display shows `Contact Saved` and a positive mini notice.

Press  or  to `No` to return to the previous step.

Each entry can be associated to different number keys. You see a  before each number key that is

assigned to an entry. If the ✓ is before Empty, that number key is not assigned.



If a number key is assigned to an entry in a particular mode, this feature is not supported when you long press the number key in another mode.



The screen automatically returns to the previous menu.

Removing Associations Between Entries and Programmable Number Keys

Follow the procedure to remove the associations between entries and programmable number keys on your radio.

- 1 Do one of the following:
 - Long press the programmed number key to the required alias or ID. Proceed to [step 4](#).
 - Press  to access the menu.

- 2 Press  or  to Contacts. Press  to select.



- 3 Press  or  to the required alias or ID.

Press  to select.

- 4 Press  or  to Program Key. Press  to select.

- 5 Press  or  to Empty. Press  to select.

The first text line shows Clear from all keys.

- 6 Press  or  to Yes. Press  to select.



NOTICE:

When an entry is deleted, the association between the entry and its programmed number key(s) is removed.



A positive indicator tone sounds. The display shows Contact Saved.



The screen automatically returns to the previous menu.



Adding New Contacts

Follow the procedure to add new contacts on your radio.

- 1 Press  to access the menu.



- 2 Press  or  to Contacts. Press  to select.

- 3 Press  or  to New Contact. Press  to select.

- 4 Press  or  to select contact type Radio Contact or Phone Contact. Press  to select.

- 5 Enter the contact number with the keypad, and press  to proceed.

- 6 Enter the contact name with the keypad, and press  to proceed.

- 7 Press  or  to the required ringer type.



Press  to select.



A positive indicator tone sounds. The display shows a positive mini notice.



Setting Default Contact

Follow the procedure to set the default contact on your radio.

- 1 Press  to access the menu.

- 2 Press  or  to Contacts. Press  to select.

- 3 Press  or  to the required alias or ID.
Press  to select.

- 4 Press  or  to Set as Default. Press  to select.





A positive indicator tone sounds. The display shows a positive mini notice. The display shows ✓ beside the selected default alias or ID.



Call Indicator Settings



This feature allows the radio users to configure call or text message ringing tones.



Activating or Deactivating Call Ringers for Call Alerts



Follow the procedure to activate or deactivate call ringers for Call Alerts on your radio.



- 1 Press  to access the menu.
-
- 2 Press  or  to Utilities. Press  to select.
-

- 3 Press  or  to Radio Settings. Press  to select.
-

- 4 Press  or  to Tones/Alert. Press  to select.
-

- 5 Press  or  to Call Ringers. Press  to select.
-



- 6 Press  or  to Call Alert. Press  to select.
-



- 7 Press  or  to the required tone. Press  to select. The display shows ✓ beside the selected tone.
-



Activating or Deactivating Call Ringers for Private Calls



Follow the procedure to activate or deactivate call ringers for Private Calls on your radio.



- 1 Press  to access the menu.

- 2 Press  or  to Utilities. Press  to select.

- 3 Press  or  to Radio Settings. Press  to select.



- 4 Press  or  to Tones/Alerts. Press  to select.



- 5 Press  or  to Call Ringers. Press  to select.

- 6 Press  or  to Private Call. Press  to select.

The display shows  beside On if Private Call ringing tones are enabled.

The display shows  beside Off if Private Call ringing tones are disabled.



- 7 Press  or  to the required tone. Press  to select.

If enabled,  appears beside Enabled. If disabled,  disappears beside Enabled.



Activating or Deactivating Call Ringers for Selective Calls



Follow the procedure to activate or deactivate call ringers for Selective Calls on your radio.



- 1 Press  to access the menu.
-

2 Press  or  to Utilities. Press  to select.



3 Press  or  to Radio Settings. Press  to select.

4 Press  or  to Tones/Alerts. Press  to select.

5 Press  or  to Call Ringers. Press  to select.

6 Press  or  to Selective Call. Press  to select.



The display shows  and the current tone.



7 Press  or  to the required tone. Press  to select. The display shows  beside the selected tone.



Activating or Deactivating Call Ringers for Text Messages



Follow the procedure to activate or deactivate call ringers for text messages on your radio.



1 Press  to access the menu.

2 Press  or  to Utilities. Press  to select.



3 Press  or  to Radio Settings. Press  to select.

4 Press  or  to Tones/Alerts. Press  to select.

5 Press  or  to Call Ringers. Press  to select.

6 Press  or  to **Text Message**. Press  to select.

The display shows  and the current tone.



7 Press  or  to the required tone. Press  to select.



The display shows  beside the newly selected tone.



Activating or Deactivating Call Ringers for Telemetry Status with Text



Follow the procedure to activate or deactivate call ringers for telemetry status with text on your radio.



1 Press  to access the menu.

2 Press  or  to **Utilities**. Press  to select.

3 Press  or  to **Radio Settings**. Press  to select.

4 Press  or  to **Tones/Alert**. Press  to select.

5 Press  or  to **Call Ringers**. Press  to select.

6 Press  or  to **Telemetry**. Press  to select.



The current tone is indicated by a .



Assigning Ring Styles



The radio can be programmed to sound one of eleven predefined ringing tones when receiving a Private Call, a Call Alert, or a Text Message from a particular contact. The radio sounds out each ring style as you navigate through



the list. Follow the procedure to assign ring styles on your radio.





- 1 Press  to access the menu.

- 2 Press  or  to **Contacts**. Press  to select.
The entries are alphabetically sorted.

- 3 Press  or  to the required alias or ID.
Press  to select.

- 4 Press  or  to **View/Edit**. Press  to select.

- 5 Press  until display shows **Ringer** menu
A  indicates the current selected tone.

- 6 Press  or  to the required tone. Press  to select.
A  appears beside the selected tone.
-

Escalating Alarm Tone Volume

The radio can be programmed to continually alert, when a radio call remains unanswered. This is done by automatically increasing the alarm tone volume over time. This feature is known as Escalart.

Call Log Features

Your radio keeps track of all recent outgoing, answered, and missed Private Calls. The call log feature is used to view and manage recent calls.

Missed Call Alerts may be included in the call logs, depending on the system configuration on your radio. You can perform the following tasks in each of your call lists:



- Store Alias or ID to Contacts
- Delete Call



- Delete All Calls
- View Details

Viewing Recent Calls

Follow the procedure to view recent calls on your radio.



- 1 Press  to access the menu.

- 2 Press  or  to Call Log. Press  to select.

- 3 Press  or  to the preferred list. The options are Missed, Answered, and Outgoing lists.

Press  to select.

The display shows the most recent entry.



- 4 Press  or  to view the list.



You can start a call with the alias or ID the display is currently showing by pressing the **PTT** button.

Deleting Calls from the Call List



Follow the procedure to delete calls from the Call list.

- 1 Press  to access the menu.



- 2 Press  or  to Call Log. Press  to select.

- 3 Press  or  to the required list. Press  to select.





If the list is empty:
 - A tone sounds.
 - The display shows List Empty.



- 4 Press  or  to the required alias or ID.

Press  to select.



- 5 Press  or  to Delete Entry?. Press  to select.

6 Do one of the following:

- Press  to select Yes to delete the entry. The display shows Entry Deleted.
 - Press  or  to No. Press  to select. The radio returns to the previous screen.
-

4 Press  or  to the required alias or ID.

Press  to select.



5 Press  or  to View Details. Press  to select.



The display shows the call details.

Viewing Call List Details

Follow the procedure to view call details on your radio.

1 Press  to access the menu.



2 Press  or  to Call Log. Press  to select.



3 Press  or  to the required list. Press  to select.



Storing Aliases or IDs from the Call List

Follow the procedure to store aliases or IDs on your radio from the Call list.



1 Press  to access the menu.

2 Press  or  to Call Log. Press  to select.

3 Press  or  to the required list. Press  to select.

4 Press  or  to the required alias or ID.

Press  to select.

5 Press  or  to Store. Press  to select.

The display shows a blinking cursor.

6 Enter the rest of the characters of the required alias.

Press  to select.

You can store an ID without an alias.

The display shows a positive mini notice.

Call Alert Operation

Call Alert paging enables you to alert a specific radio user to call you back.

This feature is applicable for subscriber aliases or IDs only and is accessible through the menu using Contacts, manual dial, or a programmed **One Touch Access** button.

Making Call Alerts

Follow the procedure to make Call Alerts on your radio.

1 Press the programmed **One Touch Access** button.

The display shows Call Alert and the subscriber alias or ID. The green LED lights up.

2 Wait for acknowledgment.



If the Call Alert acknowledgment is received, the display shows a positive mini notice.



If the Call Alert acknowledgment is not received, the display shows a negative mini notice.



Making Call Alerts by Using the Contacts List

Follow the procedure to make Call Alerts on your radio by using the Contacts list.

1 Press  to access the menu.

2 Press  or  to **Contacts**. Press  to select.

3 Press  or  to the required alias or ID.
Press  to select.

4 Press  or  to **Call Alert**. Press  to select.
The display shows **Call Alert** and the subscriber alias or ID. The green LED lights up.



5 Wait for acknowledgment.



- If the Call Alert acknowledgment is received, the display shows a positive mini notice.
- If the Call Alert acknowledgment is not received, the display shows a negative mini notice.

Making Call Alerts by Using the Manual Dial

Follow the procedure to make Call Alerts on your radio by using the manual dial.



1 Press  to access the menu.

2 Press  or  to **Contacts**. Press  to select.

3 Press  or  to **Manual Dial**. Press  to select.

The display shows a blinking cursor.

4 Enter the subscriber ID and press  to proceed.

5 Press  or  to **Call Alert**. Press  to select.

The display shows **Call Alert** and the subscriber alias or ID. The green LED lights up.

- 6 Wait for acknowledgment.
 - If the Call Alert acknowledgment is received, the display shows a positive mini notice.
 - If the Call Alert acknowledgment is not received, the display shows a negative mini notice.
-

Responding to Call Alerts

Follow the procedure to respond to Call Alerts on your radio.

When you receive a Call Alert:

- A repetitive tone sounds.
- The yellow LED blinks.
- The display shows the notification list listing a Call Alert with the alias or ID of the calling radio.

Depending on the configuration by your dealer or system administrator, you can respond to a Call Alert by doing one of the following:

- Press the **PTT** button and respond with a Private Call directly to the caller.

- Press the **PTT** button to continue normal talkgroup communication. The Call Alert is moved to the Missed Call option at the Call Log menu. You can respond to the caller from the Missed Called log.
-

See [Notification List on page 181](#) and [Call Log Features on page 122](#) for more information.

Mute Mode

Mute Mode provides an option to the user to silence all audio indicators of the radio.

Once Mute Mode feature is initiated, all audio indicators are muted except higher priority features such as Emergency operations.

When Mute Mode is exited, the radio resumes playing ongoing tones and audio transmissions.



NOTICE:

This is a purchasable feature. Check with your dealer or system administrator for more information.

Turning On Mute Mode

Follow the procedure to turn on Mute Mode.

Access this feature by using the programmed **Mute Mode** button.

The following occurs when Mute mode is enabled:



- Positive Indicator Tone sounds.
- Display shows `Mute Mode On`.
- The red LED light starts blinking and remains blinking until Mute Mode is exited.
- Display shows **Mute Mode** icon on home screen.
- Radio is muted.
- Mute Mode Timer begins counting down the duration that is configured.



Setting Mute Mode Timer



Mute Mode feature can be enabled for a pre-configured amount of time by setting the Mute Mode Timer. The timer duration is configured in the radio menu and can range between 0.5–6 hours. Mute Mode is exited once the timer expires.



If the timer is left at 0, the radio remains in Mute mode for an indefinite period until the programmed **Mute Mode** button is pressed.

- 1 Press  to access the menu.

- 2 Press  or  to Utilities. Press  to select.

- 3 Press  or  to Radio Settings. Press  to select.

- 4 Press  or  to Mute Timer. Press  to select.

- 5 Press  or  to edit the numeric value of each digit, and press .

Exiting Mute Mode

This feature can be exited automatically once the Mute Mode Timer expires.

Do one of the following to exit Mute mode manually:

- Press the programmed **Mute Mode** button.
- Press the **PTT** button on any entry.

The following occurs when Mute mode is disabled:

- Negative Indicator Tone sounds.
- Display shows `Mute Mode Off`.
- The blinking red LED turns off.
- **Mute Mode** icon disappears from home screen.
- Your radio unmutes and speaker state is restored.
- If the timer has not expired, Mute mode timer is stopped.



NOTICE:

Mute Mode is also exited if the user transmits voice or switches to an unprogrammed channel.

Emergency Operation

An Emergency Alarm is used to indicate a critical situation. You are able to initiate an Emergency at any time even when there is activity on the current channel.

Your dealer can set the duration of a button press for the programmed **Emergency** button, except for long press, which is similar with all other buttons:

Short Press

Duration between 0.05 seconds and 0.75 seconds.

Long Press

Duration between 1.00 second and 3.75 seconds.

The **Emergency** button is assigned with the Emergency On/Off feature. Check with your dealer for the assigned operation of the **Emergency** button.



NOTICE:

If a short press to the **Emergency** button initiates Emergency mode, then a long press to the same enables the radio to exit Emergency mode.

If a long press to the **Emergency** button initiates Emergency mode, then a short press to the same enables the radio to exit Emergency mode.

Your radio supports three Emergency Alarms:

- Emergency Alarm

- Emergency Alarm with Call
- Emergency Alarm with Voice to Follow 

**NOTICE:**

Only one of the Emergency Alarms above can be assigned to the programmed **Emergency** button or the Emergency footswitch.

In addition, each alarm has the following types:

Regular

Radio transmits an alarm signal and shows audio and/or visual indicators.

Silent

Radio transmits an alarm signal without any audio or visual indicators. Radio receives calls without any sound through the speaker, until the programmed *hot mic* transmission period is over and/or you press the **PTT** button.

Silent with Voice

Radio transmits an alarm signal without any audio or visual indicators, but allow incoming calls to sound through the speaker.





Receiving Emergency Alarms

Follow the procedure to receive Emergency Alarms on your radio.

When you receive an Emergency Alarm:

- A tone sounds.
- The red LED blinks.
- The display shows the **Emergency** icon, and the Emergency caller alias or if there is more than one alarm, all emergency caller aliases are displayed in an Alarm List.

1 Do one of the following:

- If only one alarm, press  to view more details.
- If more than one alarm, press  or  to the required alias, and press  to view more details.

2

Press  to view the action options.

- 3 Press  and select Yes to exit the Alarm list.



- 4 Press  to access the menu.

- 5 Select Alarm List to revisit the Alarm list.

- 6 The tone sounds and the LED blinks red until you exit the Emergency mode. However, the tone can be silenced. Do one of the following:
 - Press the **PTT** button to call the group of radios which received the Emergency Alarm.
 - Press any programmable button.
 - Exit Emergency mode. See [Exiting Emergency Mode After Receiving the Emergency Alarm on page 411](#).

Responding to Emergency Alarms

Follow the procedure to respond to Emergency Alarms on your radio.

- 1 Make sure the display shows the Alarm List. Press  or  to the required alias or ID.

- 2  If the Channel Free Indication feature is enabled, you hear a short alert tone the moment the transmitting radio releases the **PTT** button, indicating the channel is free for you to respond. Press the **PTT** button to transmit non-emergency voice to the same group the Emergency Alarm targeted.

The green LED lights up. Your radio remains in the Emergency mode.

- 3 Do one of the following:
 - Wait for the Talk Permit Tone to end and speak clearly into the microphone if enabled.
 -  Wait for the **PTT** Sidetone to end and speak clearly into the microphone if enabled.

- 4 Release the **PTT** button to listen.

When the emergency initiating radio responds:
 - The green LED blinks.

- The display shows the **Group Call** icon and ID, transmitting radio ID, and the Alarm list.

Emergency voice can only be transmitted by the emergency initiating radio. All other radios, including the emergency receiving radio, transmit non-emergency voice.

Exiting Emergency Mode After Receiving the Emergency Alarm

Do one of the following to exit Emergency mode after receiving Emergency alarm:

- Delete the alarm items.
- Power down the radio.

Sending Emergency Alarms

This feature allows you to send an Emergency Alarm, a non-voice signal, which triggers an alert indication on a group of radios. Your radio does not display any audio or visual indicators during Emergency mode when it is set to Silent.

Follow the procedure to send Emergency Alarms on your radio.

- 1 Press the programmed **Emergency On** button.

You see one of these results:

- The display shows Tx Alarms and the destination alias.
-  The display shows Tx Telegram and the destination alias.

The green LED lights up. The **Emergency** icon appears.



NOTICE:

If programmed, the Emergency Search tone sounds. This tone is muted when the radio transmits or receives voice, and stops when the radio exits Emergency mode. The Emergency Search tone can be programmed through CPS.

- 2 Wait for acknowledgment.

If successful:

- The Emergency tone sounds.
- The red LED blinks.
- The display shows Alarm Sent.

If unsuccessful after all retries have been exhausted:

- A tone sounds.
- The display shows `Alarm Failed`.

The radio exits the Emergency Alarm mode and returns to the Home screen.

Sending Emergency Alarms with Call

This feature allows you to send an Emergency Alarm with Call to a group of radios. Upon acknowledgement by a radio within the group, the group of radios can communicate over a programmed Emergency channel. Follow the procedure to send Emergency Alarms with call on your radio.

- 1 Press the programmed **Emergency On** button or the **Emergency** footswitch. The display shows Sending Alarm, which alternates with your radio ID.

You see the following:

- The display shows `Tx Telegram` and the destination alias.

The green LED lights up. The **Emergency** icon appears.



NOTICE:

If programmed, the Emergency Search tone sounds. This tone is muted when the radio transmits or receives voice, and stops when the radio exits Emergency mode. The Emergency Search tone can be programmed by your dealer or system administrator.

- 2 Wait for acknowledgment.

If successful:

- The Emergency tone sounds.
 - The red LED blinks.
 - The display shows `Alarm Sent`.
 - Your radio enters the Emergency call mode when the display shows `Emergency` and the destination group alias.
-

- 3 Press the **PTT** button to make the call.

The green LED lights up. The display shows the **Group Call** icon.

- 4 Do one of the following:

- Wait for the Talk Permit Tone to end and speak clearly into the microphone if enabled.
-  Wait for the **PTT** Sidetone to end and speak clearly into the microphone if enabled.

5 Release the **PTT** button to listen.

The display shows the caller and group aliases.

-
- #### 6 If the Channel Free Indication feature is enabled, you hear a short alert tone the moment the transmitting radio releases the **PTT** button, indicating the channel is free for you to respond. Press the **PTT** button to respond to the call.

-
- #### 7 To exit the Emergency mode once the call ends, press the **Emergency Off** button.

The radio returns to the Home screen.

Emergency Alarms with Voice to Follow

This feature allows you to send an Emergency Alarm with Voice to Follow to a group of radios. Your radio microphone

is automatically activated, allowing you to communicate with the group of radios without pressing the **PTT** button. This activated microphone state is also known as *hot mic*.



NOTICE:

Your radio cannot detect a non-IMPRES microphone that is attached to the rear accessory connector.

When no microphone is detected at the specified programmed connector, your radio checks the alternative connector. Here, your radio gives priority to the detected microphone.

If your radio has Emergency Cycle Mode enabled, repetitions of *hot mic* and receiving period are made for a programmed duration. During Emergency Cycle Mode, received calls sound through the speaker.

If you press the **PTT** button during the programmed receiving period, you hear a prohibit tone, indicating that you should release the **PTT** button. The radio ignores the **PTT** button press and remains in Emergency mode.

If you press the **PTT** button during *hot mic*, and continue to press it after the *hot mic* duration expires, the radio continues to transmit until you release the **PTT** button.

If the Emergency Alarm request fails, the radio does not retry to send the request, and enters the *hot mic* state directly.



NOTICE:

Some accessories may not support *hot mic*. Check with your dealer or system administrator for more information.

Sending Emergency Alarms with Voice to Follow

Follow the procedure to send Emergency Alarms with voice to follow on your radio.

- 1 Press the programmed **Emergency On** button or the **Emergency** footswitch.

You see one of these results:

- The display shows Tx Alarm and the destination alias.
- The display shows Tx Telegram and the destination alias.

The green LED lights up. The **Emergency** icon appears.

- 2 Once the display shows Alarm Sent, speak clearly into the microphone.

The radio automatically stops transmitting when:

- The cycling duration between *hot mic* and receiving calls expires, if Emergency Cycle Mode is enabled.
- The *hot mic* duration expires, if Emergency Cycle Mode is disabled.

-
- 3 Press the **Emergency Off** button to exit the Emergency mode.

The radio returns to the Home screen.

Reinitiating Emergency Mode

This feature is only applicable to the radio sending the Emergency Alarm. Follow the procedure to reinitiate Emergency mode on your radio.

Do one of the following:

- Change the channel while the radio is in Emergency mode. The radio exits the Emergency

mode, and reinitiates Emergency, if Emergency Alarm is enabled on the new channel.

- Press the programmed **Emergency On** button during an Emergency initiation or transmission state. The radio exits this state, and reinitiates Emergency.

Exiting Emergency Mode After Sending the Emergency Alarm

This feature is only applicable to the radio sending the Emergency Alarm.

Your radio exits Emergency mode when:

- An acknowledgment is received (for Emergency Alarm only).
- All retries to send the alarm have been exhausted.



NOTICE:

If your radio is powered off, it exits the Emergency mode. The radio does not reinitiate the Emergency mode automatically when it is turned on again.







Follow the procedure to exit Emergency mode on your radio.

Do one of the following:

- Press the programmed **Emergency Off** button.
- Change the channel to a new channel that has no emergency system configured.
The display shows No Emergency.

Deleting an Alarm Item from the Alarm List

Follow the procedure to delete the alarm items from the Alarm List, to exit Emergency mode.

- 1 Press  to access the menu.
- 2 Press  or  to Alarm List. Press  to select.
- 3 Press  or  to the required alarm item.
Press  to select.

- 4 Press  or  to Delete. Press  to select.
-

Text Messaging

Your radio is able to receive data, for example a text message, from another radio or a text message application.

There are two types of text messages, Digital Mobile Radio (DMR) Short Text Message and text message. The maximum length of a DMR Short Text Message is 23 characters. The maximum length of a text message is 280 characters, including the subject line. The subject line only appears when you receive messages from e-mail applications.



NOTICE:

The maximum character length is only applicable for models with the latest software and hardware. For radio models with older software and hardware, the maximum length of a text message is 140 characters. Check with your dealer or system administrator for more information.



Text Messages



The text messages are stored in an Inbox, and sorted according to the most recently received.



Viewing Text Messages

Follow the procedure to view text messages on your radio.

- 1 Press  to access the menu.

 - 2 Press  or  to Messages. Press  to select.

 - 3 Press  or  to Inbox. Press  to select.
If the Inbox is empty:
 - The display shows List Empty.
 - A tone sounds, if the Keypad Tone is turned on.
-

- 4 Press  or  to the required message. Press  to select.

The display shows a subject line if the message is from an e-mail application.











You cannot reply to a Telemetry Status text message.

The display shows Telemetry: <Status Text Message>.

- 5 Long press  to return to the Home screen.

Viewing Telemetry Status Text Messages

Follow the procedure to view a telemetry status text message from the inbox.

- 1 Press  to access the menu.
- 2 Press  or  to Messages. Press  to select.
- 3 Press  or  to Inbox. Press  to select.
- 4 Press  or  to the required message. Press  to select.

Responding to Text Messages

Follow the procedure to respond to text messages on your radio.

When you receive a text message:









- The display shows the Notification list with the alias or ID of the sender.
- The display shows the **Message** icon.





NOTICE:

The radio exits the Text Message alert screen and sets up a Private or Group Call to the sender of the message if the **PTT** button is pressed.

- 1 Do one of the following:

- Press  or  to Read. Press  to select.
The display shows the text message. The display shows a subject line if the message is from an e-mail application.
- Press  or  to Read Later. Press  to select.
The radio returns to the screen you were on prior to receiving the text message.
- Press  or  to Delete. Press  to select.

2 Do one of the following:

- Press  to return to inbox.
 - Press  a second time to reply, forward, or delete the text message.
-

Responding to Text Messages with Quick Text

Follow the procedure to respond to text messages with Quick Text messages on your radio.

1 Do one of the following:

- Press the programmed **Text Message** button.
Proceed to Step [step 3](#).
 - Press  to access the menu.
-

2 Press or to Messages. Press to select.



3 Press or to Inbox. Press to select.



4 Press or to the required message. Press to select.

The display shows a subject line if the message is from an e-mail application.

5 Press  to access the sub-menu.

6 Press  or  to Reply. Press  to select.

7 Press  or  to Quick Reply. Press  to select.

8 Press  or  to the required message. Press  to select.

The display shows a transitional mini notice, confirming the message is being sent.

9 Wait for acknowledgment.

If successful:

- A tone sounds.
- The display shows a positive mini notice.

If unsuccessful:

- A tone sounds.
- The display shows a negative mini notice.

- The radio returns to the Resend option screen.
-

Resending Text Messages

Follow the procedure to resend text messages on your radio.

When you are at the Resend option screen:

Press  to resend the same message to the same subscriber or group alias or ID.

If successful:

- A positive indicator tone sounds.
- The display shows a positive mini notice.



If unsuccessful:



- A negative indicator tone sounds.
 - The display shows a negative mini notice.
 - The radio returns to the Resend option screen.
-

Forwarding Text Messages

Follow the procedure to forward text messages on your radio.

When you are at the **Resend** option screen:

- 1 Press  or  to **Forward**, and press  to send the same message to another subscriber or group alias or ID.

- 2 Press  or  to the required alias or ID.
Press  to select.

The display shows a transitional mini notice, confirming your message is being sent.

- 3 Wait for acknowledgment.

If successful:

- A positive indicator tone sounds.
- The display shows a positive mini notice.

If unsuccessful:

- A negative indicator tone sounds.

- The display shows a negative mini notice.



NOTICE:



You can also manually select a target radio address (see [Forwarding Text Messages by Using the Manual Dial on page 420](#)).

Forwarding Text Messages by Using the Manual Dial

Follow the procedure to forward text messages by using the manual dial on your radio.

- 1 Press  or  to **Forward**. Press  to select.

- 2 Press  to send the same message to another subscriber or group alias or ID.

- 3 Press  or  to **Manual Dial**. Press  to select.

The display shows **Radio Number:.**

- 4 Enter the subscriber ID, and press  to proceed.
The display shows a transitional mini notice, confirming your message is being sent.
-

- 5 Wait for acknowledgment.

If successful:

- A tone sounds.
- The display shows a positive mini notice.

If unsuccessful:

- A tone sounds.
 - The display shows a negative mini notice.
-



Editing Text Messages

Select **Edit** to edit the message.









NOTICE:

If a subject line is present (for messages received from an e-mail application), you cannot edit it.







- 1 Press  or  to **Edit**. Press  to select.
The display shows a blinking cursor.
-

- 2 Use the keypad to edit your message.

- Press  to move one space to the left.
 - Press  or  to move one space to the right.
 - Press  to delete any unwanted characters.
 - Long press  to change text entry method.
-

- 3 Press  once message is composed.
-

- 4 Do one of the following:



- Press  or  to **Send** and press  to send the message.
- Press  or  to **Save** and press  to save the message to the Drafts folder.
- Press  to edit the message.

- Press  to choose between deleting the message or saving it to the Drafts folder.

Writing Text Messages

Follow the procedure to write text message on your radio.

- 1 Do one of the following:
 - Press the programmed **Text Message** button. Proceed to [step 3](#).
 - Press  to access the menu.

- 2 Press  or  to Messages. Press  to select.

- 3 Press  or  to Compose. Press  to select.

A blinking cursor appears.

- 4 Use the keypad to type your message.

Press  to move one space to the left.





Press  or  to move one space to the right.

Press  to delete any unwanted characters.

Long press  to change text entry method.

- 5 Press  once message is composed.

Do one of the following:







- Press  to send the message.
- Press . Press  or  to choose among editing, deleting, or saving the message. Press  to select.

Sending Text Messages

Follow the procedure to send text message on your radio.

It is assumed that you have a newly written text message or a saved text message.

Select the message recipient. Do one of the following:

- Press  or  to the required alias or ID. Press  to select.
- Press  or  to Manual Dial. Press  to select. Key in the subscriber ID. The first line of the display shows Radio Number:!. The second line of the display shows a blinking cursor. Key in the subscriber alias or ID. Press .

The display shows transitional mini notice, confirming your message is being sent.

If successful:

- A tone sounds.
- The display shows positive mini notice.

If unsuccessful:

- A low tone sounds.
- The display shows negative mini notice.
- The message is moved to the Sent Items folder.
- The message is marked with a Send Failed icon.



NOTICE:

For a newly written text message, the radio returns you to the Resend option screen.

Deleting Text Messages from the Inbox

Follow the procedure to delete text messages from the Inbox on your radio.

1 Do one of the following:



- Press the programmed **Text Message** button. Proceed to [step 3](#).
- Press  to access the menu.

2 Press or to Messages. Press to select.

3 Press or to Inbox. Press to select.

If the Inbox is empty:



- The display shows List Empty.
 - A tone sounds.
-

4 Press  or  to the required message. Press  to select.

The display shows a subject line if the message is from an e-mail application.

5 Press  to access the sub-menu.

6 Press  or  to Delete. Press  to select.

7 Press  or  to Yes. Press  to select.

The display shows a positive mini notice. The screen returns to the Inbox.

Deleting All Text Messages from the Inbox









Follow the procedure to delete all text messages from the Inbox on your radio.

1 Do one of the following:



- Press the programmed **Text Message** button. Proceed to [step 3](#).



- Press  to access the menu.

2 Press  or  to Messages. Press  to select.

3 Press  or  to Inbox. Press  to select. If the Inbox is empty:

- The display shows List Empty.
 - A tone sounds.
-

4 Press  or  to Delete All. Press  to select.

5 Press  or  to Yes. Press  to select.

The display shows a positive mini notice.

Sent Text Messages

Once a message is sent to another radio, it is saved in Sent Items folder. The most recent sent text message is always added to the top of the Sent Items folder. You can resend, forward, edit, or delete a Sent text message.

The Sent Items folder is capable of storing a maximum of 30 last sent messages. When the folder is full, the next sent text message automatically replaces the oldest text message in the folder.

If you exit the message sending screen while the message is being sent, the radio updates the status of the message in the Sent Items folder without providing any indication in the display or via sound.

If the radio changes mode or powers down before the status of the message in Sent Items folder is updated, the radio cannot complete any In-Progress messages and automatically marks it with a **Send Failed** icon.

The radio supports a maximum of five In-Progress messages at one time. During this period, the radio cannot send any new message and automatically marks it with a **Send Failed** icon.

If you long press  at any time, the radio returns to the Home screen.







NOTICE:



If the channel type, for example a conventional digital or Capacity Plus channel, is not a match, you can only edit, forward, or delete a Sent message.

Viewing Sent Text Messages

Follow the procedure to view sent text messages on your radio.

- 1 Do one of the following:
 - Press the programmed **Text Message** button. Proceed to [step 3](#).
 - Press  to access the menu.



- 2 Press  or  to Messages. Press  to select.

- 3 Press  or  to Sent Items. Press  to select.

If the Sent Items folder is empty:

 - The display shows `List Empty`.

- A low tone sounds, if the Keypad Tone is turned on.
-



- 4 Press  or  to the required message. Press  to select.

The icon at the top right corner of the screen indicates the status of the message. See [Sent Item Icons](#).

Sending Sent Text Messages

Follow the procedure to send a sent text message on your radio.

When you are viewing a Sent message:

- 1 Press  while viewing the message.
-
- 2 You can either resend or forward the sent text message. Do one of the following:
 -  to Resend. Press  to select.

-  to Forward. Press  to select.

The display shows a transitional mini notice, confirming your message is being sent.

- 3 Wait for acknowledgment.

If successful:

- A positive indicator tone sounds.
- The display shows a positive mini notice.

If unsuccessful:

- A negative indicator tone sounds.
 - The display shows a negative mini notice.
 - The radio proceeds to the Resend option screen. See [Resending Text Messages on page 146](#) for more information.
-

Deleting Sent Text Messages from the Sent Items Folder

Follow the procedure to delete sent text messages from the Sent Items folder on your radio.

When you are viewing a Sent message:

1 Press .



2 Press  or  to Delete. Press  to select.



Deleting All Sent Text Messages from the Sent Items Folder

Follow the procedure to delete all sent text messages from the Sent Items folder on your radio.

1 Do one of the following:



- Press the programmed **Text Message** button. Proceed to [step 3](#).
 - Press  to access the menu.
-

2 Press  or  to Messages. Press  to select.







3 Press  or  to Sent Items. Press  to select.

If the Sent Items folder is empty:

- The display shows List Empty.
 - A tone sounds.
-

4 Press  or  to Delete All. Press  to select.

5 Do one of the following:

- Press  or  to Yes. Press  to select.
The display shows a positive mini notice.
 - Press  or  to No. Press  to select.
The radio returns to the previous screen.
-

Saved Text Messages

You can save a text message to send it at a later time.

If a **PTT** button press or a mode change causes the radio to exit the text message writing/editing screen while you are in the process of writing or editing a text message, your current text message is automatically saved to the Drafts folder.



The most recent saved text message is always added to the top of the Drafts list.

The Drafts folder stores a maximum of 10 last saved messages. When the folder is full, the next saved text message automatically replaces the oldest text message in the folder.



Viewing Saved Text Messages

Follow the procedure to view saved text message on your radio.

- 1 Do one of the following:
 - Press the programmed **Text Message** button. Proceed to [step 3](#).
 - Press  to access the menu.





- 2 Press  or  to Messages. Press  to select.

- 3 Press  or  to Drafts. Press  to select.

- 4 Press  or  to the required message. Press  to select.

Editing Saved Text Messages

Follow the procedure to edit saved text message on your radio.

- 1 Press  while viewing the message.
- 2 Press  or  to Edit. Press  to select. A blinking cursor appears.
- 3 Use the keypad to type your message.

Press  to move one space to the left.







Press  or  to move one space to the right.

Press  to delete any unwanted characters.

Long press  to change text entry method.

4 Press  once message is composed.

Do one of the following:



- Press  or  to Send. Press  to send the message.
- Press . Press  or  to choose between saving or deleting the message. Press  to select.

Deleting Saved Text Messages from the Drafts Folder



Follow the procedure to delete saved text message from drafts on your radio.



1 Do one of the following:

- Press the programmed **Text Message** button. Proceed to [step 3](#).
- Press  to access the menu.

2 Press  or  to Messages. Press  to select.

3 Press  or  to Drafts. Press  to select.

4 Press  or  to the required message. Press  to select.

5 Press  or  to Delete. Press  to delete the text message.

Quick Text Messages



Your radio supports a maximum of 50 Quick Text messages as programmed by your dealer.



While Quick Text messages are predefined, you can edit each message before sending it.



Sending Quick Text Messages

Follow the procedure to send predefined Quick Text messages on your radio to a predefined alias.

- 1 Do one of the following:
 - Press the programmed **Text Message** button. Proceed to [step 6](#).
 - Press the programmed **One Touch Access** button.
The display shows a transitional mini notice, confirming your message is being sent.
Proceed to [step 6](#).
 - Press  to access the menu.
-

- 2 Press  or  to **Messages**. Press  to select.
-

- 3 Press  or  to **Quick Text**. Press  to select.
-

- 4 Press  or  to the required Quick Text message. Press  to select.
-

- 5 Do the following to select the recipient and send the message.

The display shows a transitional mini notice, confirming that your message is being sent.

- 6 Wait for acknowledgment.

If successful:

- A positive indicator tone sounds.
- The display shows a positive mini notice.

If unsuccessful:

- A negative indicator tone sounds.

- The display shows a negative mini notice.
- The radio proceeds to the Resend option screen. See [Resending Text Messages on page 146](#) for more information.

Text Entry Configuration

Your radio allows you to configure different text.

You can configure the following settings for entering text on your radio:



- Word Predict
- Word Correct
- Sentence Cap
- My Words

Your radio supports the following text entry methods:

- Numbers
- Symbols
- Predictive or Multi-Tap
- Language (If programmed)







NOTICE:



Press  at any time to return to the previous screen or long press  to return to the Home Screen. The radio exits the current screen once the inactivity timer expires.



Enabling or Disabling Word Correct



Supplies alternative word choices when the word entered into the text editor is not recognized by the in-built dictionary.

- 1 Press  to access the menu.



- 2 Press  or  to Utilities. Press  to select.

- 3 Press  or  to Radio Settings. Press  to select.

- 4 Press  or  to Text Entry. Press  to select.

5 Press  or  to Word Correct. Press  to select.



6 Do one of the following:



- Press  or  to Word Correct. Press  to select.
 - Press to enable Word Correct. If enabled, ✓ appears beside Enabled.
 - Press to disable Word Correct. If disabled, ✓ disappears beside Enabled.
-



Enabling or Disabling Word Predict



Word Predict: Your radio can learn common word sequences that you often enter. It then predicts the next word you may want to use after you enter the first word of a common word sequence into the text editor.

1 Press  to access the menu.



2 Press  or  to Utilities. Press  to select.

3 Press  or  to Radio Settings. Press  to select.

4 Press  or  to Text Entry. Press  to select.

5 Press  or  to Word Predict. Press  to select.



6 Do one of the following:



- Press  to enable the Word Predict. If enabled, ✓ appears beside Enabled.
 - Press  to disable Microphone Dynamic Distortion Control. If disabled, ✓ disappears beside Enabled.
-



Sentence Cap



This feature is used to automatically enable capitalization of the first letter in the first word for every new sentence.

- 1 Press  **OK** to access the menu.



- 2 Press  or  to Utilities. Press  **OK** to select.

- 3 Press  or  to Radio Settings. Press  **OK** to select.

- 4 Press  or  to Text Entry. Press  **OK** to select.

- 5 Press  or  to Sentence Cap. Press  **OK** to select.



- 6 Do one of the following:



- Press  **OK** to enable Sentence Cap. If enabled, ✓ appears beside Enabled.
- Press  **OK** to disable Sentence Cap. If disabled, ✓ disappears beside Enabled.



Viewing Custom Words



You can add your own custom words into the in-built dictionary of your radio. Your radio maintains a list to contain these words.



- 1 Press  **OK** to access the menu.

- 2 Press  or  to Utilities. Press  **OK** to select.

- 3 Press  or  to Radio Settings. Press  **OK** to select.

4 Press  or  to Text Entry. Press  to select.



5 Press  or  to My Words. Press  to select.



6 Press  or  to List of Words. Press  to select.
The display shows the list of custom words.



Editing Custom Words



You can edit custom words saved in your radio.



1 Press  to access the menu.



2 Press  or  to Utilities. Press  to select.

3 Press  or  to Radio Settings. Press  to select.

4 Press  or  to Text Entry. Press  to select.





5 Press  or  to My Words. Press  to select.

6 Press  or  to List of Words. Press  to select.
Display shows the list of custom words.

7 Press  or  to the required word. Press  to select.

8 Press  or  to Edit. Press  to select.

9 Use the keypad to edit your custom word.

- Press  to move one space to the left.
- Press  key to move one space to the right.
- Press the  key to delete any unwanted characters.
- Long press  to change text entry method.

10 Press  once your custom word is completed.



The display shows transitional mini notice, confirming your custom word is being saved.



- If the custom word is saved, a tone sounds and the display shows positive mini notice.
- If the custom word is not saved, a low tone sounds and the display show negative mini notice.



Adding Custom Words



You can add custom words into the in-built radio dictionary.



1 Press  to access the menu.

2 Press  or  to Utilities. Press  to select.



3 Press  or  to Radio Settings. Press  to select.



4 Press  or  to Text Entry. Press  to select.

5 Press  or  to My Words. Press  to select.

6 Press  or  to Add New Word. Press  to select.
Display shows the list of custom words.

7 Use the keypad to edit your custom word.

- Press  to move one space to the left.
- Press  key to move one space to the right.

- Press the  key to delete any unwanted characters.
- Long press  to change text entry method.

8 Press  once your custom word is completed.



The display shows transitional mini notice, confirming your custom word is being saved.



- If the custom word is saved, a tone sounds and the display show positive mini notice.
- If the custom word is not saved, a low tone sounds and the display show negative mini notice.



Deleting a Custom Word



Follow the procedure to delete the custom words saved in your radio.

1 Press  to access the menu.

2 Press  or  to Utilities. Press  to select.

3 Press  or  to Radio Settings. Press  to select.





4 Press  or  to Text Entry. Press  to select.

5 Press  or  to My Words. Press  to select.

6 Press  or  to the required word. Press  to select.

7 Press  or  to Delete. Press  to select.



8 Choose one of the following.



- At Delete Entry?, press  to select Yes. The display shows Entry Deleted.
- Press  or  to No. Press  to return to the previous screen.



Deleting All Custom Words



Follow the procedure to delete all custom words from the in-built dictionary of your radio.



- 1 Press  to access the menu.

- 2 Press  or  to Utilities. Press  to select.





- 3 Press  or  to Radio Settings. Press  to select.

- 4 Press  or  to Text Entry. Press  to select.

- 5 Press  or  to My Words. Press  to select.

- 6 Press  or  to Delete All. Press  to select.

7 Do one of the following:

- At Delete Entry?, press  to select Yes. The display shows All Entries Deleted.
 - Press  or  to No to return to the previous screen. Press  to select.
-

Job Tickets

This feature allows your radio to receive messages from the dispatcher listing out tasks to perform.



NOTICE:

This feature can be customized through CPS according to user requirements. Check with your dealer or system administrator for more information.

There are two folders that contain different Job Tickets:

My Tasks folder

Personalized Job Tickets assigned to your signed in user ID.

Shared Tasks folder

Shared Job Tickets assigned to a group of individuals.

You can respond to Job Tickets in order to sort them into Job Ticket Folders. By default, the folders are **All**, **New**, **Started**, and **Completed**. Check with your dealer or system administrator for an additional 10 folders.



NOTICE:

Job Tickets are retained even after the radio is powered down and powered up again.

All Job Tickets are located in the **All** folder. Depending on how your radio is programmed, Job Tickets are sort by their priority level followed by time received. New Job Tickets, Job Tickets with recent changes in state, and Job Tickets with the highest priority are listed first. Upon reaching the maximum number of Job Tickets, the next Job Ticket automatically replaces the last Job Ticket in your radio. Your radio supports a maximum of 100 or 500 Job Tickets, depending on your radio model. Check with your dealer or system administrator for more information. Your radio automatically detects and discards duplicated Job Tickets with the same Job Ticket ID.

Depending on the importance of the Job Tickets, the dispatcher adds a Priority Level to them. There are three priority levels: Priority 1, Priority 2, and Priority 3. Priority 1 has the highest priority and Priority 3 has the lowest priority. There are also Job Tickets with no priority.

Your radio updates accordingly when dispatcher makes the following changes:

- Modify content of Job Tickets.
- Add or edit Priority Level of Job Tickets.
- Move Job Tickets from folder to folder.
- Canceling of Job Tickets.



Accessing the Job Ticket Folder



Follow the procedure to access the Job Ticket folder.

1 Do one of the following:

- Press the programmed **Job Ticket** button. Proceed to [step 3](#).
- Press  to access the menu.





2 Press  or  to Job Tickets. Press  to select.

3 Press  or  to the required folder. Press  to select.

- 4 Press  or  to the required Job Ticket.
Press  to select.
-

Logging In or Out of the Remote Server

This feature allows you to log in and log out of the remote server by using your user ID.

- 1 Press  to access the menu.
-
- 2 Press  or  to Log In. Press  to select.
If you are already logged in, menu displays Log Out.
The display shows a transitional mini notice, indicating the request is in progress.
-
- 3 Wait for acknowledgment.
If successful:
- A positive indicator tone sounds.
 - The display shows a positive mini notice.







If unsuccessful:

- A negative indicator tone sounds.
 - The display shows a negative mini notice.
-

Creating Job Tickets

Your radio is able to create Job Tickets, which are based on a Job Ticket template and send out tasks that need to be performed.



CPS programming software is required to configure the Job Ticket template.



- 1 Press  to access the menu.
-
- 2 Press  or  to Job Tickets. Press  to select.
-
- 3 Press  or  to Create Ticket. Press  to select.
-



Responding to Job Tickets

Follow the procedure to respond to job tickets on your radio.



- 1 Press  to access the menu.

- 2 Press  or  to Job Tickets. Press  to select.

- 3 Press  or  to the required folder. Press  to select.

- 4 Press  or  to the required job ticket. Press  to select.

- 5 Press  once more to access the sub-menu.
You can also press the corresponding number key (1–9) to **Quick Reply**.

- 6 Press  or  to the required job ticket. Press  to select.

The display shows a transitional mini notice, indicating the request is in progress.

- 7 Wait for acknowledgment.

If successful:

- A positive indicator tone sounds.
- The display shows a positive mini notice.

If unsuccessful:

- A negative indicator tone sounds.
 - The display shows a negative mini notice.
-



Sending Job Tickets Using One Job Ticket Template

If your radio is configured with one Job Ticket template, perform the following actions to send the Job Ticket.

- 1 Use the keypad to type the required room number.

Press  to select.

- 2 Press  or  to Room Status. Press  to select.
-

- 3 Press  or  to the required option. Press  to select.
-

- 4 Press  or  to Send. Press  to select.

The display shows a transitional mini notice, indicating the request is in progress.

- 5 Wait for acknowledgment.

If successful:



- A positive indicator tone sounds.
- The display shows a positive mini notice.

If unsuccessful:

- A negative indicator tone sounds.
 - The display shows a negative mini notice.
-

Sending Job Tickets Using More Than One Job Ticket Template

If your radio is configured with more than one Job Ticket template, perform the following actions to send the Job Tickets.

- 1 Press  or  to the required option. Press  to select.
-

- 2 Press  or  to Send. Press  to select.

The display shows a transitional mini notice, indicating the request is in progress.

3 Wait for acknowledgment.

If successful:

- A positive indicator tone sounds.
- The display shows a positive mini notice.

If unsuccessful:

- A negative indicator tone sounds.
 - The display shows a negative mini notice.
-



Deleting Job Tickets



Follow the procedure to delete job tickets on your radio.



1 Do one of the following:

- Press the programmed **Job Ticket** button. Proceed to [step 4](#)
 - Press  to access the menu.
-

2 Press  or  to Job Tickets. Press  to select.

3 Press  or  to the required folder. Press  to select.

4 Press  or  to All folder. Press  to select.

5 Press  or  to the required Job Ticket. Press  to select.

6 Press  again while viewing the Job Ticket.

7 Press  or  to Delete. Press  to select.

The display shows a transitional mini notice, indicating the request is in progress.

8 Wait for acknowledgment.

If successful:

- A positive indicator tone sounds.
- The display shows a positive mini notice.

If unsuccessful:

- A negative indicator tone sounds.
- The display shows a negative mini notice.



Deleting All Job Tickets



Follow the procedure to delete all job tickets on your radio.



1 Do one of the following:

- Press the programmed **Job Ticket** button. Proceed to [step 3](#).
- Press  to access the menu.







2 Press  or  to Job Tickets. Press  to select.

3 Press  or  to the required folder. Press  to select.

4 Press  or  to All folder. Press  to select.

5 Press  or  to Delete All. Press  to select.

6 Do one of the following:

- Press  or  to Yes. Press  to select.
The display shows a positive mini notice.
- Press  or  to No. Press  to select.
The radio returns to the previous screen.

Privacy

This feature helps to prevent eavesdropping by unauthorized users on a channel by the use of a software-based scrambling solution. The signaling and user identification portions of a transmission are not scrambled.

Your radio must have privacy enabled on the channel to send a privacy-enabled transmission, although this is not a necessary requirement for receiving a transmission. While

on a privacy-enabled channel, the radio is still able to receive clear or unscrambled transmissions.

Some radio models may not offer Privacy feature, or may have a different configuration. Check with your dealer or system administrator for more information.

Your radio supports two types of privacy, but only one can be assigned to your radio. They are:

- Basic Privacy
- Enhanced Privacy

To unscramble a privacy-enabled call or data transmission, your radio must be programmed to have the same Privacy Key for Basic Privacy, or the same Key Value and Key ID for Enhanced Privacy as the transmitting radio.

If your radio receives a scrambled call that is of a different Privacy Key, or different Key Value and Key ID, you either hear a garbled transmission for Basic Privacy or nothing at all for Enhanced Privacy.

On a privacy-enabled channel, your radio is able to receive clear or unscrambled calls, depending on how your radio is programmed. In addition, your radio may play a warning tone or not, depending on how it is programmed.

The green LED lights up when the radio is transmitting, and blinks rapidly when the radio is receiving an ongoing privacy-enabled transmission.







NOTICE:



This feature is not applicable in Citizens Band channels that are in the same frequency.



Turning Privacy On or Off

Follow the procedure to turn privacy on or off on your radio.









- 1 Do one of the following:
 - Press the programmed **Privacy** button. Skip the steps below.
 - Press  to access the menu.

- 2 Press  or  to Utilities. Press  to select.

- 3 Press  or  to Radio Settings. Press  to select.

4 Press  or  to Privacy. Press  to select.

5 Do one of the following:

- Press  or  to On. Press  to select. The display shows  beside On.
- Press  or  to Off. Press  to select. The display shows  beside Off.

Response Inhibit

This feature helps prevent your radio from responding to any incoming transmissions.



NOTICE:

This is a purchasable feature. Check with your dealer or system administrator to determine how your radio has been programmed.

If enabled, your radio does not generate any outgoing transmissions in respond to incoming transmissions, such as Radio Check, Call Alert, Radio Disable, Remote Monitor, Automatic Registration Service (ARS), Responding to Private Messages, and Sending GNSS location reports.

Your radio cannot receive Confirmed Private Calls when this feature is enabled. However, your radio is able to manually send transmission.

Turning Response Inhibit On or Off

Follow the procedure to enable or disable Response Inhibit on your radio.

Press the programmed **Response Inhibit** button.

If successful:

- A positive indicator tone sounds.
- The display shows a momentary positive mini notice.

If unsuccessful:

- A negative indicator tone sounds.
- The display shows a momentary negative mini notice.

Multi-Site Controls

These features are applicable when your current radio channel is part of an IP Site Connect or Capacity Plus–Multi-Site configuration.

Starting Manual Site Search

Follow the procedure to start manual site search when the received signal strength is poor in order to attempt to find a site with better signal.

If the radio finds a new site:

- A positive indicator tone sounds.

If the radio fails to find a new site:

- A negative indicator tone sounds.

Site Lock On/Off

When toggled on, the radio searches the current site only. When toggled off, the radio searches other sites in addition to the current site.

Press the programmed **Site Lock** button.

If the **Site Lock** function is toggled on:

- You hear a positive indicator tone, indicating the radio has locked to the current site.
- The display shows `Site Locked`.



If the **Site Lock** function is toggled off:



- You hear a negative indicator tone, indicating the radio is unlocked.
 - The display shows `Site Unlocked`.
-



Accessing Neighbor Sites List

This feature allows the user to check the adjacent sites list of the current home site. Follow the procedure to access the Neighbor Sites List:

- 1 Press  to access the menu.

- 2 Press  or  to Utilities. Press  to select.

- 3 Press  or  to Radio Info. Press  to select.

- 4 Press  or  to Neighbor Sites. Press  to select.

Security

This feature allows you to enable or disable any radio in the system.

For example, you may want to disable a stolen radio to prevent unauthorized users from using it, and enable the radio when it is recovered.

There are two ways to enable or disable a radio, with authentication and without authentication.

Authenticated Radio Disable is a purchasable feature. In Authenticated Radio Disable, verification is required when you enable or disable a radio. When your radio initiates this feature on a target radio with User Authentication, a passphrase is required. The passphrase is preprogrammed in the target radio through CPS.

You will not receive an acknowledgment if you press  during Radio Enable or Radio Disable operation.





NOTICE:

Check with your dealer or system administrator for more information.

Disabling Radios

Follow the procedure to disable your radio.

- 1 Press the programmed **Radio Disable** button.
-

2 Press  or  to the required alias or ID.

3 Press  to select. One of the following scenarios occurs:

- The display shows a transitional mini notice, indicating the request is in progress. The green LED blinks.
- A passphrase screen appears.

Enter the passphrase. Press  to proceed.

- If the passphrase is correct, the display shows a transitional mini notice, indicating the request is in progress. The green LED lights up.
 - If the passphrase is incorrect, the display shows a negative mini notice, and returns to the previous screen.
-

4 Wait for acknowledgment.

If successful:

- A positive indicator tone sounds.
- The display shows a positive mini notice.



If unsuccessful:



- A negative indicator tone sounds.
 - The display shows a negative mini notice.
-

Disabling Radios by Using the Contacts List

Follow the procedure to disable your radio by using the Contacts list.

1 Press  to access the menu.

2 Press  or  to Contacts. Press  to select.

3 Press  or  to the required alias or ID.
Press  to select.

4 Press  or  to Radio Disable.

5 Press  to select. One of the following scenarios occurs:

- The display shows a transitional mini notice, indicating the request is in progress. The green LED blinks.
- A passphrase screen appears.

Enter the passphrase. Press  to proceed.

- If the passphrase is correct, the display shows a transitional mini notice, indicating the request is in progress. The green LED lights up.
- If the passphrase is incorrect, the display shows a negative mini notice, and returns to the previous screen.

6 Wait for acknowledgment.

If successful:

- A positive indicator tone sounds.
- The display shows a positive mini notice.

If unsuccessful:



- A negative indicator tone sounds.



- The display shows a negative mini notice.



Disabling Radios by Using the Manual Dial

Follow the procedure to disable your radio by using the manual dial.

1 Press  to access the menu.

2 Press  or  to Contacts. Press  to select.

3 Press  or  to Manual Dial. Press  to select.

4 Press  or  to Radio Number. Press  to select.

The first text line shows Radio Number:.

5 Enter the subscriber ID, and press  to proceed.

6 Press  or  to **Radio Disable**.

7 Press  to select. One of the following scenarios occurs:

- The display shows a transitional mini notice, indicating the request is in progress. The green LED blinks.
- A passphrase screen appears.

Enter the passphrase. Press  to proceed.

- If the passphrase is correct, the display shows a transitional mini notice, indicating the request is in progress. The green LED lights up.
 - If the passphrase is incorrect, the display shows a negative mini notice, and returns to the previous screen.
-

8 Wait for acknowledgment.

If successful:

- A positive indicator tone sounds.
- The display shows a positive mini notice.



If unsuccessful:

- A negative indicator tone sounds.
 - The display shows a negative mini notice.
-

Enabling Radios

Follow the procedure to enable your radio.

1 Press the programmed **Radio Enable** button.

2 Press  or  to the required alias or ID.

3 Press  to select. One of the following scenarios occurs:

- The display shows **Radio Enable** and the subscriber alias or ID. The green LED lights up.
- A passphrase screen appears.

Enter the passphrase. Press  to proceed.

- If the passphrase is correct, the display shows a transitional mini notice, indicating the

request is in progress. The green LED lights up.

- If the passphrase is incorrect, the display shows a negative mini notice, and returns to the previous screen.

4 Wait for acknowledgment.

If successful:

- A positive indicator tone sounds.
- The display shows a positive mini notice.



If unsuccessful:



- A negative indicator tone sounds.
 - The display shows a negative mini notice.
-

Enabling Radios by Using the Contacts List

Follow the procedure to enable your radio by using the Contacts list.

-
- 1 Press  to access the menu.
-

- 2 Press  or  to **Contacts**. Press  to select.
-

- 3 Press  or  to the required alias or ID.
Press  to select.
-

- 4 Press  or  to **Radio Enable**.
-

- 5 Press  to select. One of the following scenarios occurs:
 - The green LED blinks. The display shows **Radio Enable** and the subscriber alias or ID. The green LED lights up.
 - A passphrase screen appears.

Enter the passphrase. Press  to proceed.

- If the passphrase is correct, the display shows a transitional mini notice, indicating the request is in progress. The green LED lights up.

- If the passphrase is incorrect, the display shows a negative mini notice, and returns to the previous screen.

6 Wait for acknowledgment.

If successful:

- A positive indicator tone sounds.
- The display shows a positive mini notice.



If unsuccessful:



- A negative indicator tone sounds.
- The display shows a negative mini notice.



Enabling Radios by Using the Manual Dial

Follow the procedure to enable your radio by using the manual dial.

- 1 Press  to access the menu.

- 2 Press  or  to Contacts. Press  to select.

- 3 Press  or  to Manual Dial. Press  to select.

- 4 Press  or  to Private Call. Press  to select.

The first text line shows Radio Number:.

- 5 Enter the subscriber ID, and press  to proceed.

- 6 Press  or  to Radio Enable.

- 7 Press  to select. One of the following scenarios occurs:
 - The green LED blinks. The display shows Radio Enable and the subscriber alias or ID. The green LED lights up.
 - A passphrase screen appears.

Enter the passphrase. Press  to proceed.

- If the passphrase is correct, the display shows a transitional mini notice, indicating the request is in progress. The green LED lights up.
- If the passphrase is incorrect, the display shows a negative mini notice, and returns to the previous screen.

8 Wait for acknowledgment.

If successful:

- A positive indicator tone sounds.
- The display shows a positive mini notice.

If unsuccessful:

- A negative indicator tone sounds.
 - The display shows a negative mini notice.
-

Lone Worker

This feature prompts an emergency to be raised if there is no user activity, such as any radio button press or channel selection, for a predefined time.

Following no user activity for a programmed duration, the radio pre-warns you using an audio indicator once the inactivity timer expires.

If there is still no acknowledgment by you before the predefined reminder timer expires, the radio initiates an Emergency Alarm.

Only one of the following Emergency Alarms is assigned to this feature:

- Emergency Alarm
- Emergency Alarm with Call
- Emergency Alarm with Voice to Follow 

The radio remains in the emergency state, allowing voice messages to proceed until action is taken. See [Emergency Operation on page 408](#) for more information on ways to exit Emergency.

**NOTICE:**

This feature is limited to radios with this function enabled. Check with your dealer or system administrator for more information.

Bluetooth

This feature allows you to use your radio with a Bluetooth-enabled device (accessory) through a Bluetooth connection. Your radio supports both Motorola Solutions and Commercially available Off-The-Shelf (COTS) Bluetooth-enabled devices.

Bluetooth operates within a range of 10 m (32 ft) line of sight. This is an unobstructed path between your radio and your Bluetooth-enabled device. For high degree of reliability, Motorola Solutions recommends to not separate the radio and the accessory.

At the fringe areas of reception, both voice and tone quality start to sound "garbled" or "broken". To correct this problem, position your radio and Bluetooth-enabled device closer to each other (within the 10 m defined range) to re-establish clear audio reception. The Bluetooth function of your radio has maximum power of 2.5 mW (4 dBm) at the 10 m range.

Your radio can support up to three simultaneous Bluetooth connections with Bluetooth-enabled devices of unique types. For example, a headset, a scanner, and a PTT-Only Device (POD). Multiple connections with Bluetooth-enabled devices of the same type are not supported.

Refer to the user manual of your respective Bluetooth-enabled device for more details on the full capabilities of your Bluetooth-enabled device.



**NOTICE:**



If disabled through CPS, all Bluetooth-related features are disabled and the Bluetooth device database is erased.

Turning Bluetooth On and Off

Follow the procedure to turn Bluetooth on and off.









- 1 Press  to access the menu.

- 2 Press  or  to Bluetooth. Press  to select.

- 3 Press  or  to **My Status**. Press  to select.

The display shows **On** and **Off**. The current status is indicated by a .

- 4 Do one of the following:



- Press  or  to **On**. Press  to select. The display shows  beside **On**.
- Press  or  to **Off**. Press  to select. The display shows  beside **Off**.

Connecting to Bluetooth Devices

Follow the procedure to connect to Bluetooth devices.









Turn on your Bluetooth-enabled device and place it in pairing mode.

- 1 Press  to access the menu.

- 2 Press  or  to **Bluetooth**. Press  to select.

- 3 Press  or  to **Devices**. Press  to select.

- 4 Do one of the following:

- Press  or  to the required device. Press  to select.
- Press  or  to **Find Devices** to locate available devices. Press  or  to the required device. Press  to select.

- 5 Press  or  to **Connect**. Press  to select.

Your Bluetooth-enabled device may require additional steps to complete the pairing. Refer to the user manual of your Bluetooth-enabled device.

The display shows `Connecting to <Device>`.

Wait for acknowledgment.

If successful:

- A positive indicator tone sounds.
- The display shows `<Device> Connected` and the **Bluetooth Connected** icon.
- The display shows  beside the connected device.

If unsuccessful:

- A negative indicator tone sounds.
- The display shows `Connecting Failed`.









NOTICE:

If pin code is required, see [Accessing Radios by Using Passwords on page 178](#).

Connecting to Bluetooth Devices in Discoverable Mode

Follow the procedure to connect to Bluetooth devices in discoverable mode.

Turn on your Bluetooth-enabled device and place it in pairing mode.

- 1 Press  to access the menu.
- 2 Press  or  to Bluetooth. Press  to select.
- 3 Press  or  to Find Me. Press  to select. The radio can now be found by other Bluetooth-enabled devices for a programmed duration. This is called Discoverable Mode.

Wait for acknowledgment.

If successful:

- A positive indicator tone sounds.
- The display shows `<Device> Connected` and the **Bluetooth Connected** icon.

- The display shows ✓ beside the connected device.



If unsuccessful:



- A negative indicator tone sounds.
- The display shows Connecting Failed.



Disconnecting from Bluetooth Devices



Follow the procedure to disconnect from Bluetooth devices.

- 1 Press  to access the menu.

- 2 Press  or  to Bluetooth. Press  to select.

- 3 Press  or  to Devices. Press  to select.

- 4 Press  or  to the required device. Press  to select.

- 5 Press  or  to Disconnect. Press  to select.

The display shows Disconnecting from <Device>.



NOTICE:

Your Bluetooth-enabled device may require additional steps to disconnect. Refer to respective user manuals of any Bluetooth-enabled devices.

Wait for acknowledgment.

- A tone sounds.
- The display shows <Device> Disconnected and the **Bluetooth Connected** icon disappears.
- The ✓ disappears beside the connected device.

Switching Audio Route between Internal Radio Speaker and Bluetooth Device

Follow the procedure to toggle audio routing between internal radio speaker and external Bluetooth device.

Press the programmed **Bluetooth Audio Switch** button.



The display shows one of the following results:



- A tone sounds. The display shows `Route Audio to Radio.`
- A tone sounds. The display shows `Route Audio to Bluetooth.`



Viewing Device Details



Follow the procedure to view device details on your radio.

- 1 Press  to access the menu.

- 2 Press  or  to Bluetooth. Press  to select.

- 3 Press  or  to Devices. Press  to select.



- 4 Press  or  to the required device. Press  to select.



- 5 Press  or  to View Details. Press  to select.



Deleting Device Name



You can remove a disconnected device from the list of Bluetooth-enabled devices.

- 1 Press  to access the menu.

- 2 Press  or  to Bluetooth. Press  to select.

3 Press  or  to `Devices`. Press  to select.



4 Press  or  to the required device. Press  to select.



5 Press  or  to `Delete`. Press  to select. The display shows `Device Deleted`.



Bluetooth Mic Gain



This feature allows the user to control the microphone gain value of the connected Bluetooth-enabled device.

1 Press  to access the menu.

2 Press  or  to `Bluetooth`. Press  to select.

3 Press  or  to `BT Mic Gain`. Press  to select.

4 Press  or  to the `BT Mic Gain` type and the current values. Press  to select. You can edit the values here.

5 Press  or  to increase or to decrease values. Press  to select.

Indoor Location











NOTICE:

Indoor Location feature is applicable for models with the latest software and hardware. Check with your dealer or system administrator for more information.

Indoor Location is used to keep track of the location of radio users. When Indoor Location is activated, the radio is in a limited discoverable mode. Dedicated beacons are used to locate the radio and determine its position.

Turning Indoor Location On or Off

You can turn on or turn off Indoor Location by performing one of the following actions.

- Access this feature through the menu.
 - a. Press  to access the menu.
 - b. Press  or  to Bluetooth and press  to select.
 - c. Press  or  to Indoor Location and press  to select.
 - d. Press  to turn on Indoor Location.

The display shows Indoor Location On. You hear a positive indicator tone.

One of the following scenarios occurs.

- If successful, the Indoor Location Available icon appears on the Home screen display.

- If unsuccessful, the display shows Turning On Failed. You hear a negative indicator tone.

- e. Press  to turn off Indoor Location.

The display shows Indoor Location Off. You hear a positive indicator tone.

One of the following scenarios occurs.

- If successful, the Indoor Location Available icon disappears on the Home screen display.
- If unsuccessful, the display shows Turning Off Failed. You hear a negative indicator tone.

- Access this feature by using the programmed button.
 - a. Long press the programmed **Indoor Location** button to turn on Indoor Location.

The display shows Indoor Location On. You hear a positive indicator tone.

One of the following scenarios occurs.

- If successful, the Indoor Location Available icon appears on the Home screen display.

- If unsuccessful, the display shows **Turning On Failed**. If unsuccessful, you hear a negative indicator tone.
- b. Press the programmed **Indoor Location** button to turn off Indoor Location.

The display shows **Indoor Location Off**. You hear a positive indicator tone.



One of the following scenarios occurs.



- If successful, the Indoor Location Available icon disappears on the Home screen display.
- If unsuccessful, the display shows **Turning Off Failed**. If unsuccessful, you hear a negative indicator tone.



Accessing Indoor Location Beacons Information

Follow the procedure to access Indoor Location beacons information.

- 1 Press  to access the menu.
-

- 2 Press  or  to **Bluetooth** and press  to select.
-

- 3 Press  or  to **Indoor Location** and press  to select.
-

- 4 Press  or  to **Beacons** and press  to select.
-

The display shows the beacons information.

Notification List

Your radio has a Notification list that collects all your unread events on the channel, such as unread text messages, telemetry messages, missed calls, and call alerts.

The display shows the **Notification** icon when the Notification list has one or more events.



The list supports a maximum of 40 unread events. When the list is full, the next event automatically replaces the oldest event. After the events are read, they are removed from the Notification list.



For text messages, missed calls, and call alert events, the maximum number of notifications are 30 text messages and 10 missed calls or call alerts. This maximum number depends on individual feature (job tickets or text messages or missed calls or call alerts) list capability.

Accessing Notification List

Follow the procedure to access the Notification list on your radio.

- 1 Press  to access the menu.

- 2 Press  or  to Notification. Press  to select.

- 3 Press  or  to the required event. Press  to select.

Long press  to return to the Home screen.

Auto-Range Transponder System

The Auto-Range Transponder System (ARTS) is an analog-only feature designed to inform you when your radio is out-of-range of other ARTS-equipped radios.

ARTS-equipped radios transmit or receive signals periodically to confirm that they are within range of each other.

Your radio provides indications of states as follows:

First-Time Alert

A tone sounds.

The display shows `In Range` after the channel alias.

ARTS-in-Range Alert

A tone sounds, if programmed.

The display shows `In Range` after the channel alias.

ARTS-Out-of-Range Alert

A tone sounds. The red LED rapidly blinks.

The display shows `Out of Range` alternating with the Home screen.



NOTICE:

Check with your dealer or system administrator for more information.

Over-the-Air Programming

Your dealer can remotely update your radio through Over-the-Air Programming (OTAP) without any physical connection. Additionally, some settings can also be configured by using OTAP.

When your radio undergoes OTAP, the green LED blinks.

When your radio receives high volume data:

- The display shows the **High Volume Data** icon.
- The channel becomes busy.
- A negative tone sounds if you press the **PTT** button.

When OTAP completes, depending on the configuration:

- A tone sounds. The display shows `Updating`
`Restarting`. Your radio restarts by powering off and on again.
- You can select `Restart Now` or `Postpone`. When you select `Postpone`, your radio returns to the previous screen. The display shows the **OTAP Delay Timer** icon until the automatic restart occurs.

When your radio powers up after automatic restart:

- If successful, the display shows `Sw Update`
`Completed`.

- If unsuccessful, the display shows `Sw Update Failed`.

See [Checking Software Update Information on page 213](#) for the updated software version.

Transmit Inhibit

Transmit inhibit feature allow users to block all transmission from the radio.





NOTICE:

Bluetooth and Wi-Fi features are available in Transmit Inhibit mode.

Enabling Transmit Inhibit

Follow the procedure to enable Transmit Inhibit.

Perform one of the following actions:

- Press  or  to Tx Inhibit and press  to select.
- Press the **Transmit Inhibit** programmable button.

- A positive indicator tone sounds.
- The display shows `Tx Inhibit On`.



**NOTICE:**

The status of the Transmit Inhibit does not change after the radio powers up.

Disabling Transmit Inhibit

Follow the procedure to disable Transmit Inhibit.

Perform one of the following actions:

- Press  or  to Tx Inhibit and press  to select.
 - Press the **Transmit Inhibit** programmable button.
-
- A negative indicator tone sounds. Transmission is back to normal operation.
 - The display shows Tx Inhibit Off.



Selecting Third-Party Peripherals Connection Modes

Follow the procedure to select one of the following third-party peripherals connection modes:



- Motorola Solutions



- PC and Audio
- Data Accessory
- Telemetry
- Generic

1 Press  to access the menu.

2 Press  or  to Utilities. Press  to select.

3 Press  or  to Radio Settings. Press  to select.

4 Press  or  to Cable Type. Press  to select.

5 Press  or  to the required connection mode. Press  to select.

The display shows the selected connection mode.
The screen returns to the previous menu.



Received Signal Strength Indicator

This feature allows you to view the Received Signal Strength Indicator (RSSI) values.

The display shows the **RSSI** icon at the top right corner. See [Display Icons](#) for more information on the **RSSI** icon.

Viewing RSSI Values

Attach the 4-Way Navigation Keypad Microphone (Motorola Solutions part number RMN5127_) to your radio.

At the home screen, using the 4-Way Navigation Keypad Microphone, press  three times and immediately press  three times.

The display shows the current RSSI values.

To return to the home screen, press and hold .

Password Lock Features

This feature allows you to restrict access to the radio by asking for a password when the device is turned on.

You can use a keypad microphone or **Scroll Up/Down** buttons to enter the password.

Accessing Radios by Using Passwords



Follow the procedure to access your radio by using a password.

- 1 Enter the current four-digit password.



NOTICE:

The use of **Emergency** footswitch cancels out password input to access the radio.

- Use a keypad microphone.
- Press  or  to edit the numeric value of each digit, and press  to enter and move to the next digit.

- 2 Press  to enter the password.

If successful, the radio powers up.

If unsuccessful:

- After the first and second attempt, the display shows **Wrong Password**. Repeat [step 1](#).

- After the third attempt, the display shows `Wrong Password` and then, `Radio Locked`. A tone sounds. The yellow LED double blinks. Your radio enters into locked state for 15 minutes.

**NOTICE:**

In locked state, your radio responds to inputs from the **On/Off/Volume Control Knob** and programmed **Backlight** button only.

Unlocking Radios in Locked State

Your radio is unable to receive calls in locked state. Follow the procedure to unlock your radio in locked state.

Do one of the following:



- If the radio is powered on, wait for 15 minutes and then repeat the steps in [Accessing Radios by Using Passwords on page 178](#) to access the radio.
- If the radio is powered off, power up the radio. Your radio restarts the 15-minute timer for locked state. A tone sounds. The yellow LED double blinks. The display shows `Radio Locked`.



Wait for 15 minutes and then repeat the steps in [Accessing Radios by Using Passwords on page 178](#) to access the radio.



Turning Password Lock On or Off

Follow the procedure to turn password lock on or off on your radio.



- 1 Press  to access the menu.

- 2 Press  or  to `Utilities`. Press  to select.

- 3 Press  or  to `Radio Settings`. Press  to select.

- 4 Press  or  to `Passwd Lock`. Press  to select.







- 5 Enter the current four-digit password.
 - Use a keypad microphone.

- Press  or  to edit the numeric value of each digit, and press  to enter and move to the next digit.
A positive indicator tone sounds for every digit pressed.



6 Press  to enter the password.



If the password is incorrect, the display shows `Wrong Password` and automatically returns to the previous menu.



7 Do one of the following:

- Press  or  to Turn On. Press  to select.
The display shows `✓ Turn On`.
- Press  or  to Turn Off. Press  to select.
The display shows `✓ Turn Off`.

1 Press  to access the menu.



2 Press  or  to Utilities. Press  to select.

3 Press  or  to Radio Settings. Press  to select.

4 Press  or  to Passwd Lock. Press  to select.

5 Enter the current four-digit password, and press  to proceed.

If the password is incorrect, the display shows `Wrong Password` and automatically returns to the previous menu.

6 Press  or  to Change PWD. Press  to select.

Changing Passwords

Follow the procedure to change passwords on your radio.

7 Enter a new four-digit password, and press  to proceed.

8 Re-enter the new four-digit password, and press  to proceed.

If successful, the display shows *Password Changed*.
If unsuccessful, the display shows *Passwords Do Not Match*.

The screen automatically returns to the previous menu.

Front Panel Configuration



You are able to customize certain feature parameters in Front Panel Configuration (FPC) to enhance the use of your radio.



Entering Front Panel Configuration Mode

Follow the procedure to enter front panel programming mode on your radio.

Long press  at any time to return to the Home screen.





1 Press  to access the menu.

2 Press  or  to Utilities. Press  to select.

3 Press  or  to Program Radio. Press  to select.

Editing FPP Mode Parameters

Use the following buttons as required while navigating through the feature parameters.

-  ,  – Scroll through options, increase/decrease values, or navigate vertically.
-  – Select the option or enter a sub-menu.
-  – Short-press to return to previous menu or to exit the selection screen. Long-press to return to Home screen.

Wi-Fi Operation

This feature allows you to set up and connect to a Wi-Fi network. Wi-Fi supports updates for radio firmware, codeplug, and resources such as language packs and voice announcement.



NOTICE:

This feature is applicable to XiR M8668i/CM7668i only.

Wi-Fi® is a registered trademark of Wi-Fi Alliance®.

Your radio supports WEP/WPA/WPA2-Personal and WPA/WPA2-Enterprise Wi-Fi networks.

WEP/WPA/WPA2-Personal Wi-Fi network

Uses pre-shared key (password) based authentication.

Pre-shared key can be entered by using the menu or CPS/RM.

WPA/WPA2-Enterprise Wi-Fi network

Uses certificate-based authentication.

Your radio must be pre-configured with a certificate.



NOTICE:

Check with your dealer or system administrator to connect to WPA/WPA2-Enterprise Wi-Fi network.

The programmed **Wi-Fi On or Off** button is assigned by your dealer or system administrator. Check with your dealer or system administrator to determine how your radio has been programmed.

Voice Announcements for the programmed **Wi-Fi On or Off** button can be customized through CPS according to user requirements. Check with your dealer or system administrator for more information.



NOTICE:



You can turn on or turn off Wi-Fi remotely by using a supervisory radio (see [Turning Wi-Fi On or Off by Using a Supervisory Radio](#)). Check with your dealer or system administrator for more information.



Turning Wi-Fi On or Off

Follow the procedure to turn Wi-Fi on or off.

- 1 Press the programmed **Wi-Fi On or Off** button. Voice Announcement sounds Turning On Wi-Fi or Turning Off Wi-Fi.

- 2 Access this feature using the menu.
 - a Press  to access the menu.

b Press  or  to WiFi and press  to select.

c Press  or  to WiFi On and press  to select.

d Press  to turn on/off Wi-Fi.

If Wi-Fi is on, the display shows  beside Enabled.

If Wi-Fi is off, the  disappears from beside Enabled.

Turning Wi-Fi On or Off Remotely by Using a Designated Radio (Individual Control)



Follow the procedure to turn Wi-Fi on or off remotely in Individual Control (One to One).





NOTICE:

Only radio with specific CPS setting supports this function, check with your dealer or system administrator for more information.

1 Do one of the following:

- Long press the programmable button. Use the keypad to enter the ID and press  to select. Proceed to [step 3](#).
- Press  to access the menu.

2 Press  or  to Contacts and press  to select.

3 Press  or  to WiFi Control and press  to select.

4 Press  or  to select On or Off.

5 Press  to select.

If successful, the display shows a positive mini notice.

If unsuccessful, the display shows a negative mini notice.

Turning Wi-Fi On or Off Remotely by Using a Designated Radio (Group Control)



Follow the procedure to turn Wi-Fi on or off remotely in Group Control (One to Many).







NOTICE:

Only radio with specific CPS setting supports this function, check with your dealer or system administrator for more information.

- 1 Press  to access the menu.

- 2 Press  or  to `Contacts` and press  to select.

- 3 Press  or  to select the required subscriber alias or ID.

- 4 Press  or  to `WiFi Control` and press  to select.

- 5 Press  or  to select `On` or `Off`.

- 6 Press  to select.

If successful, the display shows `Sent Successfully`.

If unsuccessful, the display shows a negative mini notice.

Connecting to a Network Access Point

When you turn on Wi-Fi, the radio scans and connects to a network access point.





NOTICE:



You can also connect to a network access point using the menu.

The WPA-Enterprise Wi-Fi network access points are pre-configured. Check with your dealer or system administrator to determine how your radio has been programmed.

- 1 Press  to access the menu.

2 Press  or  to **WiFi** and press  to select.



3 Press  or  to **Networks** and press  to select.

4 Press  or  to a network access point and press  to select.



NOTICE:

For WPA-Enterprise Wi-Fi, if a network access point is not preconfigured, the **Connect** option is not available.

5 Press  or  to **Connect** and press  to select.

6 For WPA-Personal Wi-Fi, enter the password and press .

7 For WPA-Enterprise Wi-Fi, password is configured by using **RM**.

If the preconfigured password is correct, your radio automatically connects to the selected network access point.

If the preconfigured password is incorrect, the display shows **Authentication Failure**, and automatically returns to the previous menu.

If the connection is successful, the radio displays a notice and the network access point is saved into the profile list.

If the connection is unsuccessful, the radio displays shows the failure notice screen momentarily and automatically returns to the previous menu.

Checking Wi-Fi Connection Status

Follow the procedure to check the Wi-Fi Connection status.

Press the programmed **Wi-Fi Status Query** button for the connection status by using Voice Announcement. Voice

Announcement sounds Wi-Fi is Off, Wi-Fi is On but No Connection, or Wi-Fi is On with Connection.

- The display shows `WiFi Off` when the Wi-Fi is turned off.
- The display shows `WiFi On, Connected` when the radio is connected to a network.
- The display shows `WiFi On, Disconnected` when the Wi-Fi is turned on but the radio is not connected to any network.

Voice Announcements for the Wi-Fi status query results can be customized through CPS according to user requirements. Check with your dealer or system administrator for more information.









NOTICE:



The programmed **Wi-Fi Status Query** button is assigned by your dealer or system administrator. Check with your dealer or system administrator to determine how your radio has been programmed.

Refreshing the Network List

Follow the procedure to refresh the network list.

- Perform the following actions to refresh the network list through the menu.
 - a. Press  to access the menu.
 - b. Press  or  to `WiFi` and press  to select.
 - c. Press  or  to `Networks` and press  to select.

When you enter the Networks menu, the radio automatically refreshes the network list.

- If you are already in the Networks menu, perform the following action to refresh the network list.
Press  or  to `Refresh` and press  to select.

The radio refreshes and displays the latest network list.

Adding a Network









NOTICE:



This task is not applicable to WPA-Enterprise Wi-Fi networks.

If a preferred network is not in the available network list, perform the following actions to add a network.

- 1 Press  to access the menu.

- 2 Press  or  to WiFi and press  to select.

- 3 Press  or  to Networks and press  to select.

- 4 Press  or  to Add Network and press  to select.

- 5 Enter the Service Set Identifier (SSID) and press .

- 6 Press  or  to Open and press  to select.



- 7 Enter the password and press .



The radio displays a positive mini notice to indicate that the network is successfully saved.



Viewing Details of Network Access Points



You can view details of network access points.

- 1 Press  to access the menu.

- 2 Press  or  to WiFi and press  to select.

- 3 Press  or  to Networks and press  to select.

- 4 Press  or  to a network access point and press  to select.
-

- 5 Press  or  to View Details and press  to select.



NOTICE:

WPA-Personal Wi-Fi and WPA-Enterprise Wi-Fi display different details of Network Access Points.

WPA-Personal Wi-Fi

For a connected network access point, your radio displays Service Set Identifier (SSID), Security Mode, Media Access Control (MAC) address, and Internet Protocol (IP) address.

For a non-connected network access point, your radio displays SSID and Security Mode.

WPA-Enterprise Wi-Fi

For a connected network access point, your radio displays SSID, Security Mode, Identity, Extended Authentication Protocol (EAP) Method, Phase 2 Authentication, Cert Name, MAC address, IP address, Gateway, DNS1, and DNS2.

For a non-connected network access point, your radio displays SSID, Security Mode, Identity, EAP Method, Phase 2 Authentication, and Cert Name.

Removing Network Access Points









NOTICE:



This task is not applicable to Enterprise Wi-Fi networks.



Perform the following actions to remove network access points from the profile list.

- 1 Press  to access the menu.

- 2 Press  or  to WiFi and press  to select.

- 3 Press  or  to Networks and press  to select.

4 Press  or  to the selected network access point and press  to select.

5 Press  or  to Remove and press  to select.

6 Press  or  to Yes and press  to select.

The radio displays a positive mini notice to indicate that the selected network access point is successfully removed.

Utilities

This chapter explains the operations of the utility functions available in your radio.

Squelch Levels

You can adjust the squelch level to filter out unwanted calls with low signal strength or channels with noise higher than normal background.

Normal

This is the default setting.

Tight

This setting filters out unwanted calls and/or background noise. Calls from remote locations may also be filtered out.







NOTICE:



This feature is not applicable in Citizens Band channels that are in the same frequency.



Setting Squelch Levels

Follow the procedure to set the squelch levels on your radio.



- 1 Do one of the following:
 - Press the programmed **Squelch** button. Skip the following steps.
 - Press  to access the menu.
-

- 2 Press  or  to Utilities. Press  to select.
-

3 Press  or  to Radio Settings. Press  to select.

4 Press  or  to Squelch. Press  to select.

5 Do one of the following:

- Press  or  to Normal. Press  to select.

The display shows  beside Normal.

- Press  or  to Tight. Press  to select.

The display shows  beside Tight.

The screen automatically returns to the previous menu.

Power Levels

You can customize the power setting to high or low for each channel.

High

This enables communication with radios located at a considerable distance from you.

Low

This enables communication with radios in closer proximity.



NOTICE:



This feature is not applicable in Citizens Band channels that are in the same frequency.



Setting Power Levels

Follow the procedure to set the power levels on your radio.

1 Do one of the following:







- Press the programmed **Power Level** button. Skip the steps below.
 - Press  to access the menu.
-

2 Press  or  to Utilities. Press  to select.

3 Press  or  to Radio Settings. Press  to select.

4 Press  or  to Power. Press  to select.

5 Do one of the following:

- Press  or  to High. Press  to select.
The display shows ✓ beside High.
 - Press  or  to Low. Press  to select.
The display shows ✓ beside Low.
-

6 Long press  to return to the Home screen.



Turning Radio Tones/Alerts On or Off

You can enable and disable all radio tones and alerts, if needed, except for incoming Emergency alert tone . Follow



the procedure to turn tones and alerts on or off on your radio.



1 Do one of the following:

- Press the programmed **Tones/Alerts** button. Skip the following steps.
 - Press  to access the menu.
-

2 Press  or  to Utilities. Press  to select.

3 Press  or  to Radio Settings. Press  to select.











4 Press  or  to Tones/Alerts. Press  to select.



5 Press  or  to All Tones. Press  to select.

- 6 Press  to enable or disable all tones and alerts. The display shows one of the following results:
- If enabled, ✓ appears beside Enabled.
 - If disabled, ✓ disappears beside Enabled.
-

Turning Keypad Tones On or Off

Follow the procedure to turn keypad tones on or off on your radio.



- 1 Press  to access the menu.
-
- 2 Press  or  to Utilities. Press  to select.
-
- 3 Press  or  to Radio Settings. Press  to select.
-
- 4 Press  or  to Tones/Alerts. Press  to select.
-



- 5 Press  or  to Keypad Tones. Press  to select.
-



- 6 Press  to enable or disable keypad tones. The display shows one of the following results:
- If enabled, ✓ appears beside Enabled.
 - If disabled, ✓ disappears beside Enabled.
-



Setting Tones/Alerts Volume Offset Levels



This feature adjusts the volume of the tones or alerts, allowing it to be higher or lower than the voice volume. Follow the procedure to set the tones and alerts volume offset levels on your radio.

- 1 Press  to access the menu.
-
- 2 Press  or  to Utilities. Press  to select.
-

3 Press  or  to Radio Settings. Press  to select.



4 Press  or  to Tones/Alerts. Press  to select.

5 Press  or  to Vol. Offset. Press  to select.

6 Press  or  to the required volume offset level.

A feedback tone sounds with each corresponding volume offset level.



7 Do one of the following:



- Press  to select. The required volume offset level is saved.
 - Press  to exit. The changes are discarded.
-



Turning Talk Permit Tone On or Off



Follow the procedure to turn Talk Permit Tone on or off on your radio.

1 Press  to access the menu.

2 Press  or  to Utilities. Press  to select.

3 Press  or  to Radio Settings. Press  to select.

4 Press  or  to Tones/Alerts. Press  to select.

5 Press  or  to Talk Permit. Press  to select.













6 Press  to enable or disable the Talk Permit Tone.

The display shows one of the following results:

- If enabled, ✓ appears beside Enabled.
- If disabled, ✓ disappears beside Enabled.

Turning Power Up Tone On or Off







Follow the procedure to turn Power Up Tone on or off on your radio.



- 1 Press  to access the menu.
- 2 Press  or  to Utilities. Press  to select.
- 3 Press  or  to Radio Settings. Press  to select.
- 4 Press  or  to Tones/Alerts. Press  to select.
- 5 Press  or  to Power Up. Press  to select.

- 6 Press  to enable or disable the Power Up Tone. The display shows one of the following results:
 - If enabled, ✓ appears beside Enabled.
 - If disabled, ✓ disappears beside Enabled.
-









Setting Text Message Alert Tones

You can customize the text message alert tone to Momentary or Repetitive for each entry in the Contacts list. Follow the procedure to set the text message alert tones on your radio.

- 1 Press  to access the menu.
 - 2 Press  or  to Contacts. Press  to select.
 - 3 Press  or  to the required alias or ID. Press  to select.
-

4 Press  or  to Message Alert. Press  to select.

5 Do one of the following:

- Press  or  to Momentary. Press  to select.
The display shows  beside Momentary.
 - Press  or  to Repetitive. Press  to select.
The display shows  beside Repetitive.
-



Changing Display Modes



You can change the display mode of the radio between Day or Night, as needed. This feature affects the color palette of the display. Follow the procedure to change the display mode of your radio.



1 Do one of the following:





- Press the programmed **Display Mode** button.
Skip the following steps.

- Press  to access the menu.
-

2 Press  or  to Utilities. Press  to select.

3 Press  or  to Radio Settings. Press  to select.



4 Press  or  to Display. Press  to select.
The display shows Day Mode and Night Mode.



5 Press  or  to the required setting. Press  to select.
The display shows  beside the selected setting.



Adjusting Display Brightness



Follow the procedure to adjust the display brightness on your radio. Display brightness cannot be adjusted when Auto Brightness is enabled.

- 1 Do one of the following:
 - Press the programmed **Brightness** button. Skip the following steps.
 - Press  to access the menu.
-

- 2 Press  or  to Utilities. Press  to select.
-

- 3 Press  or  to Radio Settings. Press  to select.
-



- 4 Press  or  to Brightness. Press  to select.
The display shows the progress bar.
-



- 5 Press  or  to decrease or increase the display brightness. Press  to select.
The setting value is varied from 1 to 8.
-



Turning Horns/Lights On or Off

Your radio is able to notify you of an incoming call through the horns and lights feature. When activated, an incoming call sounds the horn and turns on the lights of your vehicle. This feature needs to be installed through your radio rear accessory connector by your dealer. Follow the procedure to turn all horns and lights on or off on your radio.

- 1 Do one of the following:
 - Press the programmed **Horns/Lights** button. Skip the steps below.
 - Press  to access the menu.
-



- 2 Press  or  to Utilities. Press  to select.
-



3 Press  or  to Radio Settings. Press  to select.

4 Press  or  to Horns/Lights. Press  to select.

5 Press  to enable or disable Horns/Lights. The display shows one of the following results:

- If enabled, ✓ appears beside Enabled.
 - If disabled, ✓ disappears beside Enabled.
-

3 Press  or  to Radio Settings. Press  to select.

4 Press  or  to LED Indicator. Press  to select.



5 Press  to enable or disable the LED indicator. The display shows one of the following results:

- If enabled, ✓ appears beside Enabled.
 - If disabled, ✓ disappears beside Enabled.
-

Turning LED Indicators On or Off

Follow the procedure to turn the LED indicators on or off on your radio.

1 Press  to access the menu.



2 Press  or  to Utilities. Press  to select.



Turning Public Address System On or Off



Follow the procedure to enable or disable the internal public address (PA) system of your radio.



- 1 Do one of the following:
 - Press the programmed **Public Address** button. Skip the following steps.

- Press  to access the menu.

- 2 Press  or  to Utilities. Press  to select.

- 3 Press  or  to Radio Settings. Press  to select.

- 4 Press  or  to Public Address. Press  to select.



- 5 Press  to enable or disable Public Address.
- If enabled,  appears beside Enabled.
 - If disabled,  disappears beside Enabled.



Turning External Public Address System On or Off



Follow the procedure to enable or disable the external public address (PA) system of your radio.

- 1 Do one of the following:
- Press the programmed **Ext Public Address** button. Skip the following steps.

- Press  to access the menu.

- 2 Press  or  to Utilities. Press  to select.







- 3 Press  or  to Radio Settings. Press  to select.



- 4 Press  or  to External Public Address. Press  to select.



- 5 Press  to enable or disable external public address.
- If enabled, ✓ appears beside Enabled.
 - If disabled, ✓ disappears beside Enabled.
-

Turning Introduction Screen On or Off

You can enable and disable the Introduction Screen by following the procedure.

- 1 Press  to access the menu.
-
- 2 Press  or  to Utilities. Press  to select.
-
- 3 Press  or  to Radio Settings. Press  to select.
-

- 4 Press  or  to Display. Press  to select.
-

- 5 Press  or  to Intro Screen. Press  to select.
-

- 6 Press  to enable or disable the Introduction Screen.



The display shows one of the following results:



- If enabled, ✓ appears beside Enabled.
 - If disabled, ✓ disappears beside Enabled.
-





Setting Languages

Follow the procedure to set the languages on your radio.

- 1 Press  to access the menu.
-
- 2 Press  or  to Utilities. Press  to select.
-

3 Press  or  to Radio Settings. Press  to select.



4 Press  or  to Languages. Press  to select.



5 Press  or  to the required language. Press  to select.
The display shows  beside the selected language.



Identifying Cable Type

Do the following steps to select the type of cable your radio uses.

1 Press  to access the menu.

2 Press  or  to Utilities. Press  to select.

3 Press  or  to Radio Settings. Press  to select.

4 Press  or  to Cable Type. Press  to select.

5 The current cable type is indicated by a .

Voice Operating Transmission

The Voice Operating Transmission (VOX) allows you to initiate a hands-free voice-activated call on a programmed channel. The radio automatically transmits, for a programmed period, whenever the microphone on the VOX-capable accessory detects voice.



NOTICE:

This feature is not applicable in Citizens Band channels that are in the same frequency.

You can enable or disable VOX by doing one of the following:

- Turn the radio off and then power it on again to enable VOX.

- Change the channel by using the **Scroll Up/Down** buttons to enable VOX.
- Change the channel by using the **Volume/Channel Knob** to enable VOX.
- Turn VOX on or off by using the programmed **VOX** button or menu to enable or disable VOX.
- Press the **PTT** button during radio operation to disable VOX.







NOTICE:



Turning this feature on or off is limited to radios with this function enabled. Check with your dealer or system administrator for more information.



Turning Voice Operating Transmission On or Off

Follow the procedure to turn VOX on or off on your radio.

- 1 Do one of the following:
 - Press the programmed **VOX** button. Skip the steps below.
 - Press  to access the menu.

- 2 Press  or  to Utilities. Press  to select.

- 3 Press  or  to Radio Settings. Press  to select.

- 4 Press  or  to VOX. Press  to select.

- 5 Press  to enable or disable **VOX**.



NOTICE:

If the Talk Permit Tone is enabled, use a trigger word to initiate the call. Wait for the Talk Permit Tone to finish before speaking clearly into the microphone. See [Turning Talk Permit Tone On or Off on page 196](#) for more information.

Turning Voice Announcement On or Off

This feature enables the radio to audibly indicate the current zone or channel the user has just assigned, or the programmable button the user has just pressed.

This is typically useful when the user has difficulty reading the content shown on the display.

This audio indicator can be customized according to customer requirements. Follow the procedure to turn Voice Announcement on or off on your radio.

Turning Option Board On or Off

Option board capabilities within each channel can be assigned to programmable buttons. A channel can support up to 6 option board features. Follow the procedure to turn option board on or off on your radio.

Press the programmed **Option Board** button.

Text-to-Speech

The Text-to-Speech feature can only be enabled by your dealer or system administrator. If Text-to-Speech is enabled, the Voice Announcement feature is automatically disabled. If Voice Announcement is enabled, then the Text-to-Speech feature is automatically disabled.

This feature enables the radio to audibly indicate the following features:



- Current Channel
- Current Zone
- Programmed button feature on or off
- Content of received text messages
- Content of received Job Tickets



This audio indicator can be customized per customer requirements. This feature is typically useful when the user is in a difficult condition to read the content shown on the display.



Setting Text-to-Speech



Follow the procedure to set the Text-to-Speech feature.

- 1 Press  to access the menu.

- 2 Press  or  to Utilities. Press  to select.

- 3 Press  or  to Radio Settings. Press  to select.

- 4 Press  or  to Voice Announcement.
Press  to select.
-

- 5 Press  or  to any of the following features.
Press  to select.

The available features are as follows:



- All
- Messages
- Job Tickets
- Channel
- Zone
- Program Button



✓ appears beside the selected setting.



Turning Automatic Call Forwarding On or Off



You can enable your radio to automatically forward voice calls to another radio.



- 1 Press  to access the menu.

- 2 Press  or  to Utilities. Press  to select.

- 3 Press  or  to Radio Settings. Press  to select.

- 4 Press  or  to Call Forward. Press  to select.



- 5 Do one of the following:
 - Press  or  to enable Call Forwarding. If enabled, ✓ appears beside Enabled.



- Press  or  to disable Call Forwarding. If disabled, ✓ disappears beside Enabled.
-



Setting Menu Timer



You can set the time your radio stays in the menu before it automatically switches to the Home screen. Follow the procedure to set the menu timer.



- 1 Press  to access the menu.

- 2 Press  or  to Utilities. Press  to select.

- 3 Press  or  to Radio Settings. Press  to select.

- 4 Press  or  to Display. Press  to select.

- 5 Press  or  to Menu Timer. Press  to select.

- 6 Press  or  to the required setting. Press  to select.



Turning Analog Microphone AGC On or Off



The Analog Microphone Automatic Gain Control (AGC) controls the microphone gain of the radio automatically while transmitting on an analog system.

This feature suppresses loud audio or boosts soft audio to a preset value in order to provide a consistent level of audio. Follow the procedure to turn Analog Microphone AGC on or off on your radio.

- 1 Press  to access the menu.

- 2 Press  or  to Utilities. Press  to select.

3 Press  or  to Radio Settings. Press  to select.

4 Press  or  to Mic AGC-A. Press  to select.

5 Press  to enable or disable Analog Microphone AGC.

The display shows one of the following results:

- If enabled, ✓ appears beside Enabled.
 - If disabled, ✓ disappears beside Enabled.
-



Turning Digital Microphone AGC On or Off



The Digital Microphone Automatic Gain Control (AGC) controls the microphone gain of the radio automatically while transmitting on a digital system.



This feature suppresses loud audio or boosts soft audio to a preset value in order to provide a consistent level of

audio. Follow the procedure to turn Digital Microphone AGC on or off on your radio.

1 Press  to access the menu.

2 Press  or  to Utilities. Press  to select.

3 Press  or  to Radio Settings. Press  to select.

4 Press  or  to Mic AGC-D. Press  to select.

5 Press  to enable or disable Digital Microphone AGC.

The display shows one of the following results:

- If enabled, ✓ appears beside Enabled.
 - If disabled, ✓ disappears beside Enabled.
-

Turning Intelligent Audio On or Off



Your radio automatically adjusts the audio volume to overcome current background noise in the environment, inclusive of both stationary and non-stationary noise sources. This is a receive-only feature and does not affect transmission audio. Follow the procedure to turn Intelligent Audio on or off on your radio.









NOTICE:

This feature is not applicable during a Bluetooth session.







- 1 Do one of the following:
 - Press the programmed **Intelligent Audio** button. Skip the steps below.
 - Press  to access the menu.

- 2 Press  or  to Utilities. Press  to select.

- 3 Press  or  to Radio Settings. Press  to select.

- 4 Press  or  to Intelligent Audio. Press  to select.



- 5 Do one of the following:

- Press  or  to On. Press  to select. The display shows ✓ beside On.
- Press  or  to Off. Press  to select. The display shows ✓ beside Off.

Turning the Acoustic Feedback Suppressor Feature On or Off

This feature allows you to minimize Acoustic Feedback Suppressor in received calls. Follow the procedure to turn the Acoustic Feedback Suppressor on or off on your radio.

- 1 Press  to access the menu.

2 Press  or  to Utilities. Press  to select.

3 Press  or  to Radio Settings. Press  to select.

4 Press  or  to AF Suppressor. Press  to select.

5 Do one of the following:



- Press to enable Acoustic Feedback Suppressor. If enabled, ✓ appears beside Enabled.
 - Press to disable Acoustic Feedback Suppressor. If disabled, ✓ disappears beside Enabled.
-



Turning Trill Enhancement On or Off



You can enable this feature when you are speaking in a language that contains many words with alveolar trill (rolling "R") pronunciations. Follow the procedure to turn Trill Enhancement on or off on your radio.

1 Do one of the following:







- Press the programmed **Trill Enhancement** button. Skip the steps below.
 - Press  to access the menu.
-

2 Press  or  to Utilities. Press  to select.

3 Press  or  to Radio Settings. Press  to select.

4 Press  or  to Trill Enhance. Press  to select.

5 Do one of the following:

- Press  or  to On. Press  to select. The display shows ✓ beside On.
 - Press  or  to Off. Press  to select. The display shows ✓ beside Off.
-

Audio Ambience

You can customize the audio ambience for your radio according to your environment.

Default

This is the default setting.

Loud

This setting enables Noise Suppressor and increases speaker loudness for use in noisy surroundings.



Work Group



This setting enables AF Suppressor and disables AGC for use when a group of radios are near to each other.



Setting Audio Ambience



Follow the procedure to set the audio ambience on your radio according to your environment.

- 1 Press  to access the menu.

- 2 Press  or  to Utilities. Press  to select.

- 3 Press  or  to Radio Settings. Press  to select.

- 4 Press  or  to Audio Ambience. Press  to select.

- 5 Press  or  to the required setting. Press  to select.

The settings are as follows.

- Choose **Default** for the default factory settings.
- Choose **Loud** to increase speaker loudness when using in noisy surroundings.
- Choose **Work Group** to reduce acoustic feedback when using with a group of radios that are near to each other.

The display shows  beside the selected setting.

Audio Profiles

You can customize the audio profiles for your radio according to your preference.

Default

This is the default setting.

Level 1, Level 2, and Level 3

These settings are intended to compensate for noise-induced hearing loss that is typical for adults in their 40's, 50's, and 60's or over.

Treble Boost, Mid Boost, and Bass Boost



These settings are intended for a tinnier sound, a more nasal sound, and a deeper sound.



Setting Audio Profiles



Follow the procedure to set audio profiles on your radio.

- 1 Press  to access the menu.

- 2 Press  or  to Utilities. Press  to select.

- 3 Press  or  to Radio Settings. Press  to select.

- 4 Press  or  to Audio Profiles. Press  to select.

- 5 Press  or  to the required setting. Press  to select.

The settings are as follows.

- Choose **Default** to disable the previously selected audio profile and return to the default factory settings.
- Choose **Level 1**, **Level 2**, or **Level 3** for audio profiles intended to compensate for noise-induced hearing loss that is typical for adults over 40 years of age.
- Choose **Treble Boost**, **Mid Boost**, or **Bass Boost** for audio profiles that align with your

preference for tinnier, more nasal, or deeper sounds.

The display shows ✓ beside the selected setting.

Turning Global Navigation Satellite System On or Off



Global Navigation Satellite System (GNSS) is a satellite navigation system that determines the radio precise location. GNSS includes Global Positioning System (GPS) and BeiDou Navigation Satellite System (BDS).





NOTICE:

Selected radio models may offer GPS and BDS. GNSS constellation is configured by using CPS. Check with your dealer or system administrator to determine how your radio has been programmed.

- 1 Do one of the following steps to toggle GNSS on or off on your radio.
 - Press the programmed **GNSS** button.
 - Press  to access the menu. Proceed to the next step.

- 2 Press  or  to Utilities. Press  to select.

- 3 Press  or  to Radio Settings. Press  to select.

- 4 Press  or  to GNSS. Press  to select.

- 5 Press  to enable or disable GNSS.
 - If enabled, ✓ appears beside Enabled.
 - If disabled, ✓ disappears beside Enabled.

Flexible Receive List



Flexible Receive List is a feature that allows you to create and assign members on the receive talkgroup list. Your radio can support a maximum of 16 members in the list. This feature is supported in Capacity Plus.

Turning Flexible Receive List On or Off







Follow the procedure to turn Flexible Receive List on or off.

1 Do one of the following:

- Press the programmed **Flexible Receive List** button. Skip the following steps.
- Press  to access the menu.

2 Press  or  to Flexible Rx List. Press  to select.

3 Do one of the following:

- Press  or  to Turn On. Press  to select.
A positive indicator tone sounds.
The display shows a positive mini notice.
- Press  or  to Turn Off. Press  to select.
A negative indicator tone sounds.
The display shows a negative mini notice.

General Radio Information



Your radio contains information on various general parameters.

The general information of your radio is as follows:

- Radio alias and ID.
- Firmware and Codeplug versions.
- Software update.
- GNSS information.
- Site information.



NOTICE:

Press  to return to the previous screen. Long press  to return to the Home screen. The radio exits the current screen once the inactivity timer expires.

Checking Radio Alias and ID



Follow the procedure to check the radio alias and ID on your radio.



1 Do one of the following:



- Press the programmed **Radio Alias and ID** button. Skip the following steps. A positive indicator tone sounds.

You can press the programmed **Radio Alias and ID** button to return to the previous screen.

- Press  to access the menu.

2 Press  or  to Utilities. Press  to select.



3 Press  or  to Radio Info. Press  to select.



4 Press  or  to My ID. Press  to select.
The first text line shows the radio alias. The second text line shows the radio ID.



Checking Firmware and Codeplug Versions

Follow the procedure to check the firmware and codeplug versions on your radio.

1 Press  to access the menu.

2 Press  or  to Utilities. Press  to select.

3 Press  or  to Radio Info. Press  to select.



4 Press  or  to Versions. Press  to select.



The display shows the current firmware and codeplug versions.



Checking Software Update Information

This feature shows the date and time of the latest software update carried out through OTAP or Wi-Fi. Follow the procedure to check the software update information on your radio.

1 Press  to access the menu.

2 Press  or  to Utilities. Press  to select.

3 Press  or  to Radio Info. Press  to select.

4 Press  or  to SW Update. Press  to select.

The display shows the date and time of the latest software update.

Software Update menu is only available after at least one successful OTAP or Wi-Fi session. See [Over-the-Air Programming on page 463](#) for more information.



Checking GNSS Information

Displays the GNSS information on your radio, such as values of:



- Latitude
- Longitude
- Altitude



- Direction
- Velocity
- Horizontal Dilution of Precision (HDOP)
- Satellites
- Version

1 Press  to access the menu.

2 Press  or  to Utilities. Press  to select.

3 Press  or  to Radio Info. Press  to select.



4 Press  or  to GNSS Info. Press  to select.



5 Press  or  to the required item. Press  to select. The display shows the requested GNSS information.



Displaying Site Information

Follow the procedure to display the current site name your radio is on.

- 1 Press  to access the menu.

- 2 Press  or  to Utilities. Press  to select.

- 3 Press  or  to Radio Info. Press  to select.



- 4 Press  or  to Site Info. Press  to select.



The display shows the current site name.



Viewing Enterprise Wi-Fi Certificate Details

You can view the details of the selected Enterprise Wi-Fi Certificate.

- 1 Press  to access the menu.

- 2 Press  or  to Utilities. Press  to select.

- 3 Press  or  to Certificate Menu. Press  to select.
 ✓ appears beside ready certificates.

- 4 Press  or  to the required certificate.
 Press  to select.

Your radio displays the full details of the certificate.



NOTICE:

For unready certificates, the display shows only Status.

Authorized Accessories List

Motorola Solutions provides a list of accessories to improve the productivity of your radio.

Antenna

- Combination GNSS (GPS/Galileo/QZSS/GLONASS), UHF, 403–527 MHz, 2.0 dB Gain, Through-Hole Mount, BNC (HAE6017_)
- Combination GPS/UHF, 470 – 527 MHz, 1/4 Wave, Through-Hole Mount, BNC (HAE6018_)
- UHF, 403–527 MHz, 2.0 dB Gain, Through-Hole Mount, BNC (HAE6021_)
- Combination GPS/UHF, 494 – 512 MHz, 3.0 dB Gain, Through-Hole Mount, BNC (HAE6023_)
- Combination GPS/UHF, 470 – 494 MHz, 3.0 dB Gain, Through-Hole Mount, BNC (HAE6025_)
- 800/900, 806-941 MHz, Stubby, Through-hole Mount, Mini U (HAF4013_)
- 800/900, 806-941 MHz, 1/4 Wave, Through-hole Mount, Mini U (HAF4025_)
- 800/900, 806-941 MHz, 3dB Gain, Through-hole Mount, Mini U (HAF4026_)
- 800/900, 806–941 MHz, 5.0dB Gain, Through-Hole Mount, Mini-U (HAF4027_)
- Combination GPS+RF, 806–941 MHz, 1/4 Wave, Through-Hole Mount, Mini-U (HAF4029_)
- Combination GPS+RF, 806–941 MHz, 3.0 dB Gain, Through-Hole Mount, Mini-U (HAF4030_)
- Combination GPS+RF, 806–941 MHz, 5.0 dB Gain, Through-Hole Mount, Mini-U (HAF4032_)
- Combination GPS+RF, 806–941 MHz, 5.0 dB Gain, Through-Hole Mount, Mini-U (HAF4033_)
- UHF, 300–340 MHz, 1/4 Wave, Through-Hole Mount, BNC (PMAD4140_)
- Combination GPS/GNSS/UHF, 350–400 MHz, 1/4 Wave, Through-Hole Mount, BNC (PMAD4102_)
- UHF, 350–400 MHz, 1/4 Wave, Through-Hole Mount, BNC (PMAD4107_)
- UHF, 320–360 MHz, 1/4 Wave, Through-Hole Mount, BNC (PMAD4141_)

- Combination GNSS (GPS/Galileo/QZSS/GLONASS), UHF, 300–340 MHz, 1/4 Wave, Through-Hole Mount, BNC (PMAD4142_)
- Combination GNSS (GPS/Galileo/QZSS/GLONASS), UHF, 320–360 MHz, 1/4 Wave, Through-Hole Mount, BNC (PMAD4143_)
- Combination GNSS (GPS/Galileo/QZSS/GLONASS), UHF, 403–430 MHz, 1/4 Wave, Through-Hole Mount, BNC (PMAE4035_)
- Combination GNSS (GPS/Galileo/QZSS/GLONASS), UHF, 406–420 MHz, 3.5 dB Gain, Through-Hole Mount, BNC (PMAE4036_)
- Combination GNSS (GPS/Galileo/QZSS/GLONASS), UHF, 450–470 MHz, 1/4 Wave, Through-Hole Mount, BNC (PMAE4037_)
- Combination GNSS (GPS/Galileo/QZSS/GLONASS), UHF, 450–470 MHz, 5 dB Gain, Through-Hole Mount, BNC (PMAE4038_)
- Fixed Mount GPS Active Antenna (PMAN4000_)
- Window Mount GPS Active Antenna (PMAN4001_)
- Magnetic Mount GPS Active Antenna (PMAN4002_)
- Combination GNSS (GPS/Galileo/QZSS/BeiDou-2), NMO Mount Base, BNC (PMAN4003_)
- VHF, 136–144 MHz, 1/4 Wave, Through-Hole Mount, BNC (RAD4198_)
- VHF, 146–150.8 MHz, 1/4 Wave, Through-Hole Mount, BNC (RAD4199_)
- VHF, 150.8–162 MHz, 1/4 Wave, Through-Hole Mount, BNC (RAD4200_)
- VHF, 162–174 MHz, 1/4 Wave, Through-Hole Mount, BNC (RAD4201_)
- Combination GNSS (GPS/Galileo/QZSS/GLONASS), VHF, 136–144 MHz, 1/4 Wave, Through-Hole Mount, BNC (RAD4219_)
- Combination GNSS (GPS/Galileo/QZSS/GLONASS), VHF, 146–150.8 MHz, 1/4 Wave, Through-Hole Mount, BNC (RAD4220_)
- Combination GNSS (GPS/Galileo/QZSS/GLONASS), VHF, 150.8–162 MHz, 1/4 Wave, Through-Hole Mount, BNC (RAD4221_)
- Combination GNSS (GPS/Galileo/QZSS/GLONASS), VHF, 162–174 MHz, 1/4 Wave, Through-Hole Mount, BNC (RAD4222_)
- UHF, 403–430 MHz, 1/4 Wave, Through-Hole Mount, BNC (RAE4151_)

- UHF, 450–470 MHz, 1/4 Wave, Through-Hole Mount, BNC (RAE4152_)
- UHF, 450–470 MHz, 5.0 dB Gain, Through-Hole Mount, BNC (RAE4154_)
- UHF, 406–420 MHz, 3.5 dB Gain, Through-Hole Mount, BNC (RAE4158_)

For use with base PMAN4003_ only:

- UHF, 494–512 MHz, 3.0 dB Gain, Through-Hole Mount (HAE6027_)
- UHF, 470–494 MHz, 3.0 dB Gain, Through-Hole Mount (HAE6028_)
- UHF, 403–527 MHz, 2.0 dB Gain, Through-Hole Mount (HAE6029_) (also for use with standard antenna bases)
- UHF, 470–527 MHz, 1/4 Wave, Through-Hole Mount (HAE6030_)
- UHF, 403–430 MHz, 1/4 Wave (PMAE4039_)
- UHF, 450–470 MHz, 1/4 Wave (PMAE4041_)
- UHF, 406–420 MHz, 3.5 dB Gain (PMAE4040_)
- UHF, 450–470 MHz, 3.5 dB Gain (PMAE4042_)
- UHF, 450–470 MHz, 5.0 dB Gain (PMAE4043_)
- VHF, 162–174 MHz, 1/4 Wave (RAD4223_)

- VHF, 150.8–162 MHz, 1/4 Wave (RAD4224_)
- VHF, 146–150.8 MHz, 1/4 Wave (RAD4225_)
- VHF, 136–144 MHz, 1/4 Wave (RAD4226_)
- VHF, 146–172 MHz, 3.0 dB Gain (RAD4227_)

Audio Accessories

- HK200 Bluetooth Headset with US Plug (89409N)
- HK200 Bluetooth Headset with UK Plug (ASMHK200VP-GB2A)
- HK200 Bluetooth Headset with Euro Plug (ASMHK200-GB3A)
- HK200 Bluetooth Headset with Korea Plug (ASMHK200-KR2A)
- HK200 Bluetooth Headset with China Plug (ASMHK200-CN2A)
- HK200 Bluetooth Headset with Australia Plug (ASMHK200-AU2A)
- Telephone Style Handset (HMN4098_)
- Operations Critical Wireless Earpiece, 12 in. Cable (NNTN8125_)

- Operations Critical Wireless Earpiece, 9.5 in. Cable (NNTN8126_)
- Operations Critical Wireless Push-to-Talk POD (NNTN8127_)
- Non-Secure Wireless Headset & Push-to-Talk Device with Push-to-Talk Audio, 12-Inch Cable (NNTN8189_)
- Bluetooth Accessory Kit, SP, 9.5 in. Cable (NNTN8190_)
- Wireless Covert Kit, includes two sets of 2-Wire Earbuds (1 Black and 1 White), 1-Wire Earbud (Black), and a 3.5 mm Adapter to plug into any off-the-shelf headphones (NNTN8296_) ¹⁴
- Wireless Neckloop Y-adapter and retention hook for Completely Discreet Kit (NNTN8385_) ¹⁶
- Business Wireless Accessory Kit (PMLN6463_)
- Wireless R2.17A Long Range Remote Speaker Microphone (PMMN4095_)
- Wireless R2.17 Mobile Microphone Gateway (PMMN4097_)
- Flexible Fit Swivel Earpiece with Boom Mic (PMLN7181_) ¹⁶
- Flexible Fit Swivel Earpiece with Boom Mic, Multipack (PMLN7203_) ¹⁶
- Completely Discreet Earpiece Kit (RLN4922_) ¹⁶
- XBT Behind-the-Neck, Non-secure Wireless Heavy Duty Headset (RLN6490_)
- XBT Overhead, Non-secure Wireless Heavy Duty Headset (RLN6491_)
- Swivel Earpiece with In-Line Microphone for Bluetooth Accessory Kit Pod, Pack of 3 (RLN6550_) ¹⁶
- Desktop Microphone (RMN5050_)
- Compact Microphone (RMN5052_)
- IMPRES 4-Way Navigation Keypad Microphone (RMN5127_)
- Heavy Duty Microphone with Enhanced Audio (RMN5053_)
- Visor Microphone with Enhanced Audio (RMN5054_)

Cables

- Compact Microphone Replacement Cable (3075336B07)

¹⁴ Your radio is compatible with the accessories listed here. Contact your dealer for details.

- Heavy Duty/Keypad Microphone Replacement Cable (3075336B10)
- Power Cable to Battery, 10-foot (3-metre) Cable, 15 amp (1–25 Watt) (HKN4137_)
- Power Cable to Battery, 10-foot (3-metre) Cable, 20 amp (1–45 Watt) (HKN4191_)
- Power Cable to Battery, 20-foot (6-metre) Cable, 20 amp (1–45 Watt) (HKN4192_)
- Mobile Front (MMP) Programming Cable (HKN6184_)
- MAP Programming Cable (PMKN4010_)
- MAP Programming and Test Cable (PMKN4016_)
- Mobile and Repeater Rear Accessory Connector Universal Cable (PMKN4018_)
- Mobile Mic Extension Cable, 10 feet (PMKN4033_)
- Mobile Mic Extension Cable, 20 feet (PMKN4034_)
- Remote Mount (3-metre) Cable (PMKN4143_)
- Remote Mount (5-metre) Cable (PMKN4144_)
- Ignition Sense Cable (RKN4136_)

Desktop Accessories

- US Line Cord (3060665A04)
- Radio Power Cable for GPN6145 (GKN6266_)
- Desktop Tray without Speaker (GLN7318_)
- Switchmode Power Supply (1 – 25 Watt Models) (CE marked) (GPN6145_)
- Power Supply and Cable (HPN4007_)
- Power Supply 14 Volt 15 Amp UNI 117/240 VAC, UK Plug (HPN4011_)
- Power Supply 14 Volt 15 Amp UNI 117/240 VAC, US Plug (HPN4007_)
- Hardware Kit for Rear Accessory Connector (PMLN5072_)
- Desktop Tray with Speaker (RSN4005_)

Mounting Kits

- Screen Protector, Clear (single pack contains one unit) (AY000269A01_) ¹⁵
- In Dash (DIN) Mounting Kit (RLN6465_)

¹⁵ Your radio is compatible with the accessories listed here. Contact your dealer for details.

- Low Profile Trunnion Kit (RLN6466_)
- High Profile Trunnion Kit (RLN6467_)
- Key Lock Trunnion Kit (RLN6468_)
- Low Profile Trunnion – Bag (RLN6469_)
- Remote Mount Transceiver Interface (PMLN6402_)
- Remote Mount Control Head Interface (PMLN6403_)

Miscellaneous Accessories

- Surge Protector, Tower Mount Kit (DQT1)
- Surge Protector, Coax Protector Bulkhead (DSISB50LNC2MA)
- PL259/Mini-U Antenna Adapter, 8 feet (2.4 metre) Cable (HKN9557_)
- Microphone Hang Up Clip (All Microphones) (HLN9073_)
- Universal Microphone Hang Up Clip (All Microphones) (HLN9414_)
- IMPRES Mobile MMP Non-PC Adapter (PMKN4072_)
- IMPRES Mobile MAP Non-PC Adapter (PMKN4070_)

- Generic Option Board (PMLN5718_S)
- Operations Critical Wireless 1-Wire Surveillance Kit with translucent tube (PMLN7052_) ¹⁶
- Push Button PTT (RLN5926_)
- Emergency Footswitch (RLN5929_)

Speakers

- 13 W External Speaker (RSN4002_)
- 7.5 W External Speaker (RSN4003_)
- 5 W External Speaker (RSN4004_)

¹⁶ Your radio is compatible with the accessories listed here. Contact your dealer for details.

目录

重要安全信息.....	21
软件版本.....	22
版权.....	23
计算机软件版权.....	24
操作预防措施.....	25
章节 1: 基本操作.....	26
打开对讲机.....	26
关闭对讲机.....	26
调节音量.....	26
章节 2: 对讲机控件.....	27
音量/信道旋钮.....	27
设置双用旋钮操作首选项.....	28
键盘麦克风按钮.....	28
章节 3: WAVE.....	31
WAVE OnCloud/OnPremise.....	31
从对讲机模式切换到 WAVE 模式.....	31
发起 WAVE 组呼.....	32
接收和响应 WAVE 组呼.....	32
接收和响应 WAVE 单呼.....	32

从 WAVE 模式切换到对讲机模式.....	33
WAVE Tactical/5000.....	33
设置活动 WAVE 信道.....	33
查看 WAVE 信道信息.....	34
查看 WAVE 端点信息.....	34
更改 WAVE 配置.....	34
发起 WAVE 组呼.....	35
部分 I: Capacity Max 操作.....	36
通话按键 (PTT).....	36
可预设按钮.....	36
可分配的对讲机功能.....	36
可分配的设置或实用功能.....	38
访问预设的功能.....	39
状态指示灯.....	39
图标.....	39
LED 指示灯.....	45
提示音.....	45
音频提示音.....	46
提示音.....	46
注册.....	46
区域和信道选择.....	47

选择区域.....	47	发起单呼.....	58
使用别名搜索选择区域.....	48	使用可预设的数字键发起单呼	58
选择呼叫类型.....	48	使用别名搜索发起单呼	59
选择站点.....	49	使用单键呼叫按钮进行单呼.....	60
漫游请求.....	49	使用手动拨号发起单呼	61
站点锁定开/关.....	49	接收单呼.....	62
站点限制.....	49	接受单呼.....	62
站点集群.....	50	拒绝单呼.....	62
呼叫.....	50	全呼.....	63
组呼.....	51	发起全呼.....	63
发起组呼.....	51	使用可预设的数字键发起全呼	63
使用通讯录列表发起组呼.....	52	使用别名搜索发起全呼.....	64
使用可预设的数字键发起组呼	52	接收全呼.....	65
使用别名搜索发起组呼	53	电话呼叫.....	66
回复组呼.....	55	发出电话呼叫.....	66
广播呼叫.....	55	使用可预设按钮进行电话呼叫 	67
发起广播呼叫.....	55	使用通讯录列表发出电话呼叫	68
使用通讯录列表发起广播呼叫.....	56	使用别名搜索发出电话呼叫.....	70
使用可预设的数字键发起广播呼 叫	56	使用手动拨号发出电话呼叫.....	72
接收广播呼叫.....	57	双音多频.....	74
单呼.....	57		

发起 DTMF 呼叫.....	74	连接到蓝牙设备.....	84
回复全呼电话呼叫.....	74	连接至处于可发现模式下的蓝牙设备	85
回复组呼电话呼叫.....	75	断开与蓝牙设备的连接.....	85
回复单呼电话呼叫.....	75	在对讲机内部扬声器和蓝牙设备之间切换音频路由.....	86
呼叫抢占.....	76	查看设备详情.....	86
语音中断.....	76	删除设备名称.....	86
启用语音中断.....	76	蓝牙麦克风增益.....	87
高级功能.....	77	室内定位.....	87
呼叫排队.....	77	打开或关闭室内定位.....	87
优先呼叫.....	78	访问室内定位信标信息.....	89
通话组扫描.....	78	多站点控制.....	89
打开或关闭通话组扫描.....	78	启动手动站点搜索.....	89
接收组列表.....	79	站点锁定开/关.....	89
优先级监听.....	80	访问邻域站点列表.....	90
编辑通话组的优先级.....	80	主信道提醒.....	90
多通话组加入.....	81	使主信道提醒静音.....	90
添加通话组加入.....	81	设置新的主信道.....	90
删除通话组加入.....	82	远程监听.....	91
对讲.....	82	开始远程监听.....	91
蓝牙.....	83	使用通讯录列表启动远程监听	92
打开和关闭蓝牙.....	83		

使用手动拨号启动远程监听.....	92	发起呼叫提示.....	103
通讯录设置.....	93	使用通讯录列表发起呼叫提示....	103
将条目分配至可编程数字键.....	94	对呼叫提示做出响应.....	103
删除条目和可编程数字键之间的 关联	94	静音模式.....	104
添加新联系人.....	95	打开静音模式.....	104
呼叫提醒设置.....	96	设置静音模式计时器.....	104
激活或停用单呼呼叫铃声.....	96	退出静音模式.....	105
激活或停用短信呼叫铃声.....	96	紧急操作.....	105
激活或停用呼叫提示的呼叫铃声..	97	发送紧急警报.....	106
激活或停用选择呼叫的呼叫铃声..	97	发送带呼叫的紧急警报.....	107
激活或停用带文本的遥感遥测状 态的呼叫铃声.....	98	发送带语音跟随的紧急警报.....	108
指定铃音类型.....	98	接收紧急警报.....	110
渐强警报音.....	99	对紧急警报做出响应	110
呼叫记录功能.....	99	对带呼叫的紧急警报做出响应....	111
查看最近呼叫.....	99	Status Message	112
从呼叫列表存储别名或 ID.....	100	发送状态信息.....	112
删除呼叫列表中的呼叫.....	100	通过使用预设按钮发送状态信息..	113
删除呼叫列表中的全部呼叫.....	101	使用通讯录列表发送状态信息....	113
查看呼叫列表中的详情.....	102	通过使用手动拨号发送状态信息..	114
呼叫提醒操作.....	102	查看状态信息.....	115
		回复状态信息.....	115

删除状态信息.....	116	删除已发信息文件夹中的	
删除所有状态信息.....	116	全部已发送短信.....	126
短信发送.....	117	保存的短信.....	127
短信.....	117	查看已保存的短信.....	127
查看短信.....	117	编辑已保存的短信.....	127
查看遥感遥测状态短信....	117	删除“草稿箱”文件夹中保	
回复短信.....	118	存的短信.....	128
用预制短信回复短信.....	119	预制短信	128
重发短信.....	120	发送预制短信	128
转发短信.....	120	文本输入配置.....	129
使用手动拨号转发短信....	121	启用或禁用文字校正.....	130
编辑短信.....	121	启用或禁用词语预测.....	130
编写短信.....	122	句首大写.....	131
发送短信.....	123	查看自定义字词.....	132
删除收件箱中的短信.....	123	编辑自定义字词.....	132
删除收件箱中的所有短信.	124	添加自定义字词.....	133
发送短信.....	124	删除自定义字词.....	134
查看已发送短信.....	125	删除全部自定义字词.....	135
发送已发送短信.....	125	任务.....	135
删除已发信息文件夹中的		访问“任务”文件夹.....	136
已发送短信.....	126	登录远程服务器或从远程服务器	
		注销	136

创建任务.....	137	解除对讲机锁定状态.....	147
回复任务.....	137	打开或关闭开机密码.....	148
使用一个任务模板发送任务.....	138	更改密码.....	149
使用多个任务模板发送任务.....	139	通知列表.....	149
删除任务.....	139	访问通知列表.....	150
删除所有任务.....	140	无线编程.....	150
加密.....	141	选择第三方外围设备连接模式.....	150
打开或关闭加密.....	141	接收信号强度指示.....	151
响应抑制.....	142	查看 RSSI 值.....	151
打开或关闭响应抑制.....	142	前面板配置.....	151
临时关闭/恢复.....	142	进入前面板配置模式.....	151
临时关闭对讲机.....	142	编辑 FPP 模式参数.....	152
使用通讯录列表临时关闭对讲机.....	143	Wi-Fi 操作.....	152
使用手动拨号临时关闭对讲机.....	144	打开或关闭 Wi-Fi.....	153
恢复对讲机.....	144	使用指定的对讲机（单独控制）	
使用通讯录列表恢复对讲机.....	145	远程打开或关闭 Wi-Fi.....	153
使用手动拨号恢复对讲机.....	145	使用指定的对讲机（通话组控	
对讲机终止.....	146	制）远程打开或关闭 Wi-Fi.....	154
单独工作者.....	146	连接到网络接入点.....	154
开机密码功能.....	147	检查 Wi-Fi 连接状态.....	155
使用密码访问对讲机.....	147	刷新网络列表.....	155
		添加网络.....	156



查看网络接入点的详细信息.....	157	打开或关闭开机界面.....	167
删除网络接入点.....	157	设置语言.....	168
动态通话组号码分配 (DGNA).....	158	识别线缆类型.....	168
发起 DGNA 呼叫.....	159	打开或关闭语音提示.....	168
发起非 DGNA 呼叫.....	159	打开或关闭选件板.....	169
接收和响应 DGNA 呼叫.....	159	文本转语音.....	169
实用工具.....	160	设置文本转语音.....	169
功率级别.....	160	设置菜单计时器.....	170
设置功率级别.....	160	打开或关闭数字麦克风 AGC.....	170
打开或关闭对讲机音调/提示.....	161	打开或关闭智能音频.....	171
打开或关闭键盘音.....	161	打开或关闭回声抑制器功能.....	171
设置音调/提示音量偏移度.....	162	打开或关闭抖音增强功能.....	172
打开或关闭通话许可提示音.....	162	音频环境.....	173
打开或关闭开机音.....	163	设置音频环境.....	173
设置短信提示音.....	163	音频配置文件.....	173
更改显示模式.....	164	设置音频配置文件.....	174
调节显示屏亮度.....	164	打开或关闭全球导航卫星系统.....	174
打开/关闭喇叭/灯.....	165	一般对讲机信息.....	175
打开或关闭 LED 指示灯.....	166	查看对讲机别名和 ID.....	175
打开或关闭公共广播系统.....	166	检查固件版本和 Codeplug 版本.....	176
打开或关闭外部公共广播系统.....	167	检查软件更新信息.....	176

检查 GNSS 信息.....	176	选择站点.....	188
显示站点信息.....	177	漫游请求.....	188
查看企业 Wi-Fi 证书详细信息.....	177	站点锁定开/关.....	188
部分 II: Connect Plus 操作.....	179	站点限制.....	189
在 Connect Plus 模式下的附加对讲机控件.....	179	选择区域.....	189
通话按键 (PTT).....	179	使用多个网络.....	190
可预设按钮.....	179	选择呼叫类型.....	190
可分配的对讲机功能.....	179	接收和回复对讲机呼叫.....	190
可分配的设置或实用功能.....	181	接收和回复组呼.....	190
在 Connect Plus 模式中识别状态指示		接收和回复单呼.....	191
灯	181	接收站点全呼.....	191
显示屏图标.....	181	接收入站单呼电话.....	192
呼叫图标.....	184	在入站单呼电话中发起缓	
高级菜单图标.....	185	冲分机拨号.....	192
已发信息图标.....	185	在入站单呼电话中发起实	
蓝牙设备图标.....	186	时分机拨号.....	193
LED 指示灯.....	186	接收入站电话通话组呼叫.....	193
提示音.....	187	入站电话多组呼.....	193
提示音.....	187	发起对讲机呼叫.....	193
在 Connect Plus 和非 Connect Plus 模		使用信道选择旋钮进行呼叫.....	194
式之间切换.....	187	发起组呼.....	194
在 Connect Plus 模式下发起和接收呼叫.....	188	发起单呼.....	194

进行站点全呼.....	195	发送对讲机检测.....	202
发起多组呼.....	195	远程监听.....	203
使用单键呼叫按钮进行单呼.....	196	开始远程监听.....	203
使用预设的手动拨号按钮进行呼		扫描.....	204
叫	196	开始和停止扫描.....	204
发起单呼.....	196	在扫描期间响应发射信号.....	205
使用预设的手动拨号按钮发起出		用户可配置扫描.....	205
站单呼电话.....	197	开启或关闭扫描.....	206
通过电话菜单发起出站单呼电话.	197	编辑扫描列表.....	206
从通讯录发起出站单呼电话.....	198	通过添加扫描信道菜单添加或删除组....	207
等待出站单呼电话的信道授权....	199	了解扫描操作.....	209
在已连接的出站单呼电话中发起		扫描对讲.....	209
缓冲分机拨号.....	199	编辑通话组的优先级.....	209
在已连接的出站单呼电话中发起		通讯录设置.....	210
实时分机拨号.....	200	从通讯录发起单呼.....	211
在 Connect Plus 模式下的高级功能.....	200	通过别名搜索发起呼叫.....	211
主信道提醒.....	200	新建联系人.....	212
自动降级.....	200	呼叫提醒设置.....	213
自动降级模式指示.....	201	激活和停用呼叫提示的呼叫铃声.	213
在降级模式下发起/接收呼叫.....	201	激活和停用单呼呼叫铃声.....	213
返回正常操作.....	202	激活和停用短信呼叫铃声.....	214
对讲机检测.....	202		

选择铃声提示类型.....	215	发起紧急呼叫.....	223
渐强警报音.....	215	发起带语音跟随的紧急呼叫.....	223
电话记录.....	215	发起紧急提示.....	224
查看最近呼叫.....	215	退出紧急呼叫模式.....	224
删除呼叫列表中的呼叫.....	216	短信发送.....	225
查看呼叫列表中的详情.....	216	发送预制短信.....	225
呼叫提醒操作.....	217	使用单键接入按钮发送预制短信.....	226
对呼叫提示做出响应.....	217	访问草稿箱文件夹.....	226
从通讯录列表发起呼叫提醒.....	217	查看已保存的短信.....	226
使用单键接入按钮发出呼叫提醒.....	218	编辑和发送已保存的短信.....	227
静音模式.....	218	从“草稿箱”中删除已保存 的短信.....	227
打开静音模式.....	219	管理发送失败的短信.....	228
设置静音模式计时器.....	219	重发短信.....	228
退出静音模式.....	219	转发短信.....	228
紧急操作.....	220	管理已发送短信.....	229
接收呼入紧急呼叫.....	221	查看已发送短信.....	229
将紧急呼叫详情保存在警报列表 中.....	221	发送已发送的短信.....	229
删除紧急呼叫详情.....	222	在“已发信息”里删除所有 已发送短信.....	230
回复紧急呼叫.....	222	接收短信.....	231
回复紧急提示.....	222	阅读短信.....	231
忽略紧急恢复呼叫.....	223		

管理收到的短信.....	232	打开或关闭室内定位.....	243
查看收件箱中的短信.....	232	访问室内定位信标信息.....	244
回复收件箱中的短信.....	232	通知列表.....	245
删除收件箱中的短信.....	233	访问通知列表.....	245
删除收件箱中的所有短信.....	234	Wi-Fi 操作.....	245
加密.....	235	打开或关闭 Wi-Fi.....	246
发起启用加密（已加密）的呼叫.....	236	使用指定的对讲机（单独控制）	
Security	236	远程打开或关闭 Wi-Fi.....	246
对讲机遥毙.....	236	使用指定的对讲机（通话组控	
对讲机激活.....	237	制）远程打开或关闭 Wi-Fi.....	247
蓝牙操作.....	239	连接到网络接入点.....	248
打开和关闭蓝牙.....	239	检查 Wi-Fi 连接状态.....	249
查找和连接到蓝牙设备.....	240	刷新网络列表.....	249
从蓝牙设备查找和连接（可发现		添加网络.....	249
模式）.....	240	查看网络接入点的详细信息.....	250
断开与蓝牙设备的连接.....	241	删除网络接入点.....	251
在对讲机内部扬声器和蓝牙设备		实用工具.....	252
之间切换音频路由.....	242	打开或关闭对讲机提示音/提示... ..	252
查看设备详情.....	242	设置提示音音量偏移度.....	252
删除设备名称.....	242	打开或关闭通话许可提示音.....	253
蓝牙麦克风增益.....	243	打开或关闭开机提示音.....	254
室内定位.....	243	设置功率级别.....	254

更改显示模式.....	255	查看固件版本和 Codeplug 版本.....	266
调节屏幕亮度.....	255	检查更新.....	266
打开或关闭开机界面.....	256	查看企业 Wi-Fi 证书详细信息.....	273
语言.....	256	部分 III: 其他系统.....	274
打开或关闭 LED 指示灯.....	257	通话按键.....	274
识别线缆类型.....	257	可预设按钮.....	274
语音提示.....	258	可分配的对讲机功能.....	274
菜单计时器.....	258	可分配的设置或实用功能.....	277
打开/关闭喇叭/灯.....	259	访问预设的功能.....	277
设置双用旋钮操作首选项.....	259	状态指示灯.....	278
数字麦克风 AGC (麦克风 AGC- D)	260	图标.....	278
智能音频.....	261	LED 指示灯.....	284
打开或关闭回声抑制器功能.....	262	提示音.....	285
打开或关闭 GNSS.....	262	提示音.....	285
访问一般对讲机信息.....	263	音频提示音.....	285
检查对讲机型号索引.....	264	传统模拟和数字模式.....	285
检查选件板 OTA Codeplug 文件的 CRC....	264	图标信息.....	286
显示站点 ID (站点编号)	264	IP 站点连接 	286
查看站点信息.....	265	智能信道共享--单站点 	287
检查对讲机 ID.....	266	智能信道共享--多站点 	287

区域和信道选择.....	288	使用可预设的数字键发起全呼 	297
选择区域.....	288	选择呼叫 	297
使用别名搜索选择区域.....	288	发起选择呼叫.....	297
选择信道.....	289	回复选择呼叫 	298
呼叫.....	289	电话呼叫 	298
组呼.....	290	发出电话呼叫 	299
发起组呼.....	290	使用通讯录列表发出电话呼叫 	300
使用通讯录列表发起组呼.....	290	使用手动拨号发出电话呼叫  ...	302
使用可预设的数字键发起组呼 	291	通过别名搜索进行组呼、单呼、	
	291	电话呼叫或全呼  	304
回复组呼.....	292	双音多频.....	305
单呼 	292	发起 DTMF 呼叫.....	305
发起单呼 	293	回复组呼电话呼叫 	305
使用通讯录列表发起单呼 	293	回复全呼电话呼叫 	306
使用手动拨号发起单呼 	294	回复单呼电话呼叫 	306
使用可预设的数字键发起单呼 	295	停止对讲机呼叫 	307
	295	脱网.....	307
回复单呼 	295	在中继器和脱网模式之间切换....	308
全呼.....	296	广播语音呼叫.....	308
接收全呼.....	296		
发起全呼.....	296		

发起广播语音呼叫.....	308	使用通讯录列表启动远程监听 ...	317
使用可预设的数字键发起广播语音呼叫		使用手动拨号启动远程监听  ...	318
语音呼叫 	309	扫描列表.....	319
使用别名搜索发起广播语音呼叫		查看扫描列表中的条目.....	319
	309	使用别名搜索查看扫描列表中的条目	320
接收广播语音呼叫.....	310	向扫描列表添加新条目.....	320
无地址呼叫.....	311	使用别名搜索向扫描列表添加新条目 	321
发起无地址呼叫.....	311	删除扫描列表中的条目.....	322
响应无地址呼叫.....	312	设置扫描列表中条目的优先级....	322
开放语音信道模式 (OVCM).....	312	扫描.....	323
发起 OVCM 呼叫.....	312	开启或关闭扫描.....	323
响应 OVCM 呼叫.....	313	在扫描期间对发射做出响应.....	324
高级功能.....	313	删除无用信道.....	324
主信道提醒.....	313	恢复无用信道.....	324
使主信道提醒静音.....	314	投票扫描 	325
设置新的主信道.....	314	通讯录设置.....	325
对讲机检测 	314	使用通讯录列表发起组呼.....	325
发送对讲机检测 	314	使用通讯录列表发起单呼 	326
使用手动拨号发送对讲机检测 	315	将条目分配至可编程数字键  ...	327
远程监听.....	316		
开始远程监听.....	316		

删除条目和可编程数字键之间的 关联 	327	使用手动拨号发起呼叫提示.....	336
添加新联系人.....	328	对呼叫提示做出响应.....	337
设置默认联系人 	329	静音模式.....	337
呼叫提醒设置.....	329	打开静音模式.....	337
激活或停用呼叫提示的呼叫铃声.....	329	设置静音模式计时器.....	338
激活或停用单呼呼叫铃声 	330	退出静音模式.....	338
激活或停用选择呼叫的呼叫铃声 	330	紧急操作.....	339
激活或停用短信呼叫铃声 	331	接收紧急警报.....	339
激活或停用带文本的遥感遥测状 态的呼叫铃声.....	331	对紧急警报做出响应.....	340
指定铃音类型.....	332	接收紧急报警后退出紧急呼叫模 式.....	341
渐强警报音.....	332	发送紧急警报.....	341
呼叫记录功能.....	333	发送带呼叫的紧急警报.....	342
查看最近呼叫.....	333	带语音跟随的紧急警报.....	343
删除呼叫列表中的呼叫 	333	发送带语音跟随的紧急警报 	343
查看呼叫列表详情 	334	重新启动紧急呼叫模式.....	344
从呼叫列表存储别名或 ID 	334	发送紧急报警后退出紧急模式....	344
呼叫提醒操作.....	335	从警报列表中删除警报项目.....	344
发起呼叫提示.....	335	短信发送.....	345
使用通讯录列表发起呼叫提示....	335	短信 	345
		查看短信.....	345

查看遥感遥测状态短信....	346	编辑已保存的短信.....	355
回复短信 	346	删除“草稿箱”文件夹中保 存的短信.....	356
用预制短信回复短信 	347	预制短信 	356
重发短信.....	348	发送预制短信 	356
转发短信 	348	文本输入配置.....	357
使用手动拨号转发短信 	349	启用或禁用文字校正.....	358
.....	349	启用或禁用词语预测.....	358
编辑短信.....	349	句首大写.....	359
编写短信.....	350	查看自定义字词.....	360
发送短信.....	351	编辑自定义字词.....	360
删除收件箱中的短信.....	351	添加自定义字词.....	361
删除收件箱中的所有短信 	352	删除自定义字词.....	362
发送短信 	352	删除全部自定义字词.....	363
查看已发送短信 	353	任务.....	363
发送已发送短信 	353	访问“任务”文件夹.....	364
删除已发信息文件夹中的 已发送短信 	354	登录远程服务器或从远程服务器 注销.....	364
删除已发信息文件夹中的 全部已发送短信.....	354	创建任务.....	365
保存的短信.....	355	回复任务.....	365
查看已保存的短信.....	355	使用一个任务模板发送任务.....	366
		使用多个任务模板发送任务.....	367

删除任务.....	367	连接至处于可发现模式下的蓝牙设备	379
删除所有任务.....	368	断开与蓝牙设备的连接.....	379
加密 ●	369	在对讲机内部扬声器和蓝牙设备之间切换音频路由.....	380
打开或关闭加密 ●	369	查看设备详情.....	380
响应抑制.....	370	删除设备名称.....	380
打开或关闭响应抑制.....	370	蓝牙麦克风增益.....	381
多站点控制.....	370	室内定位.....	381
启动手动站点搜索.....	370	打开或关闭室内定位.....	381
站点锁定开/关.....	371	访问室内定位信标信息.....	382
访问邻域站点列表.....	371	通知列表.....	383
安保 ●	371	访问通知列表.....	383
禁用对讲机 ●	372	自动范围应答机系统 ●	383
使用通讯录列表禁用对讲机 ●	372	无线编程 ●	384
使用手动拨号禁用对讲机 ●	373	禁止发射.....	384
激活对讲机 ●	374	启用禁止发射.....	384
使用通讯录列表激活对讲机 ●	375	禁用禁止发射.....	385
使用手动拨号激活对讲机 ●	375	选择第三方外围设备连接模式.....	385
单独工作者.....	376	接收信号强度指示.....	385
蓝牙.....	377	查看 RSSI 值.....	385
打开和关闭蓝牙.....	377	开机密码功能.....	386
连接到蓝牙设备.....	378		

使用密码访问对讲机.....	386	功率级别.....	396
解除对讲机锁定状态.....	386	设置功率级别.....	396
打开或关闭开机密码.....	387	打开或关闭对讲机音调/提示.....	397
更改密码.....	388	打开或关闭键盘音.....	397
前面板配置.....	388	设置音调/提示音量偏移度.....	398
进入前面板配置模式.....	388	打开或关闭通话许可提示音.....	399
编辑 FPP 模式参数.....	389	打开或关闭开机音.....	399
Wi-Fi 操作.....	389	设置短信提示音.....	400
打开或关闭 Wi-Fi.....	390	更改显示模式.....	400
使用指定的对讲机（单独控制）		调节显示屏亮度.....	401
远程打开或关闭 Wi-Fi.....	390	打开/关闭喇叭/灯.....	401
使用指定的对讲机（通话组控		打开或关闭 LED 指示灯.....	402
制）远程打开或关闭 Wi-Fi.....	391	打开或关闭公共广播系统.....	402
连接到网络接入点.....	391	打开或关闭外部公共广播系统.....	403
检查 Wi-Fi 连接状态.....	392	打开或关闭开机界面.....	403
刷新网络列表.....	392	设置语言.....	404
添加网络.....	393	识别线缆类型.....	404
查看网络接入点的详细信息.....	394	声控发射.....	404
删除网络接入点.....	394	打开或关闭声控发射.....	405
实用工具.....	395	打开或关闭语音提示.....	405
降噪级别.....	395	打开或关闭选件板.....	406
设置降噪水平.....	395		

文本转语音.....	406	显示站点信息.....	416
设置文本转语音.....	406	查看企业 Wi-Fi 证书详细信息.....	416
打开或关闭自动呼叫转移.....	407	部分 IV: 授权附件列表.....	417
设置菜单计时器.....	407		
打开或关闭模拟麦克风 AGC.....	408		
打开或关闭数字麦克风 AGC.....	408		
打开或关闭智能音频.....	409		
打开或关闭回声抑制器功能.....	409		
打开或关闭抖音增强功能.....	410		
音频环境.....	410		
设置音频环境.....	411		
音频配置文件.....	411		
设置音频配置文件.....	412		
打开或关闭全球导航卫星系统.....	412		
灵活接收列表 	413		
打开或关闭灵活接收列表.....	413		
一般对讲机信息.....	413		
查看对讲机别名和 ID.....	414		
检查固件版本和 Codeplug 版本.....	414		
检查软件更新信息.....	415		
检查 GNSS 信息.....	415		

重要安全信息

车载台双向对讲机的射频能量辐射和产品安全手册

注意！

此对讲机仅限职业应用。在使用本对讲机之前，请阅读车载台双向对讲机的射频能量辐射和产品安全手册，其中包括安全操作说明以及射频能量信息和控制，以确保符合适用的标准和法规。

要获得经 **Motorola Solutions** 核准的天线和其他附件的清单，请访问以下网站：

<http://www.motorolasolutions.com>

对于泰国市场上出售的型号：

อุปกรณ์โทรคมนาคมนี้ปฏิบัติตามข้อกำหนดของคณะกรรมการกิจการโทรคมนาคมแห่งชาติ
โทรคมนาคมแห่งชาติ
此电信设备符合泰国国家电信委员会的要求。

软件版本

软件版本 **R02.10.00.0000** 或更高版本支持以下章节中介绍的所有功能。

请参阅[检查固件版本](#)和 [Codeplug 版本 \(第 176 页\)](#)以确定您的对讲机软件版本。

请联系您的经销商或系统管理员了解详情。

版权

本文中介绍的 **Motorola Solutions** 产品可能包含受版权保护的 **Motorola Solutions** 计算机程序。美国和其它国家/地区的法律保护 **Motorola Solutions** 对受版权保护的计算机程序的某些专有权利。因此，未经 **Motorola Solutions** 明确的书面许可，不得以任何方式对本文中介绍的 **Motorola Solutions** 产品中包含的任何受版权保护的 **Motorola Solutions** 计算机程序进行复制或分发。

© 2019 Motorola Solutions, Inc. 保留所有权利

未经 **Motorola Solutions, Inc.** 的事先书面许可，不得以任何形式或通过任何手段，对本文档的任何部分进行复制、传播、存储在检索系统中，或翻译为任何语言或计算机语言。

除此之外，购买这些产品将不被认为拥有直接或暗示的版权人之版权、专利或专利使用的任何许可证授权，产品销售过程中法律运用所引起的普通非专有性免税许可证除外。

免责声明

请注意，此文档中介绍的具体特点、设备和功能有可能不适用于或未授权给特定系统中使用，或者取决于特定无线用户设备的特性或特定参数的配置。请联系 **Motorola Solutions** 以获取详细信息。

商标

MOTOROLA、**MOTO**、**MOTOROLA SOLUTIONS** 和风格化的 **M** 徽标是 **Motorola Trademark Holdings, LLC** 的商标或注册商标，经许可方可使用。所有其他商标均为其各自所有者的财产。

欧盟 (EU) 废弃电子电气设备 (WEEE) 指令



■ 欧盟的 **WEEE** 指令要求销售到欧盟国家/地区的产品必须在产品上（有时是在包装上）张贴带交叉符的垃圾箱标签。

根据 **WEEE** 指令的定义，此带叉号的垃圾箱符号表示欧盟国家/地区的客户和最终用户不得将此电子电气设备或附件作为生活垃圾处置。

欧盟国家/地区的客户或最终用户应联系当地的设备供应商代表或服务中心，以了解有关各国家/地区废物收集系统的信息。

计算机软件版权

本手册所介绍的 **Motorola Solutions** 可能包括存储于半导体存储器或其他介质中的受版权保护的 **Motorola Solutions** 计算机程序。美国和其他国家/地区的法律保护 **Motorola Solutions** 的某些有版权的计算机程序的专有权利，其中包括以任何形式拷贝或复制有版权的计算机程序的权利。因此，在未经 **Motorola Solutions** 书面允许的情况下，不允许以任何形式对本手册所介绍的 **Motorola Solutions** 产品所包含的任何受版权保护的 **Motorola Solutions** 计算机程序进行拷贝、复制、修改、反向工程或分发。而且，购买 **Motorola Solutions** 的产品并不能认为是直接或者暗示获得 **Motorola Solutions** 的版权许可、专利或者专利申请，产品销售过程中法律运用所引起的普通非专有性许可证除外。

本产品中嵌入的 **AMBE+2™** 语音编码技术受知识产权保护，包括 **Digital Voice Systems, Inc.** 的专利权、版权和商业秘密。

该语音编码技术单独授权供该通信设备使用。明确禁止该技术用户对其进行反编译、逆向工程或拆解结果代码，或以其他方式将结果代码转换成人可读取的格式。

美国专利号：**#5,870,405**、**#5,826,222**、**#5,754,974**、**#5,701,390**、**#5,715,365**、**#5,649,050**、**#5,630,011**、**#5,581,656**、**#5,517,511**、**#5,491,772**、**#5,247,579**、**#5,226,084** 和 **#5,195,166**。

操作预防措施

MOTOTRBO 系列便携式数字对讲机符合 IP67 规格，让对讲机可耐受恶劣的现场工作条件，例如被浸没在水中。本节介绍一些基本操作预防措施。



警告：

请勿拆卸对讲机。这样可能会损坏对讲机密封垫，并造成通往对讲机内部的漏洞。对讲机维护只能在可以检测对讲机的密封性和更换密封件的服务站进行。

- 如果对讲机被浸没在水中，用力挥动对讲机，将积留在扬声器网罩和麦克风接口内的水甩出。积留的水分会导致音质降低。
 - 如果对讲机的电池触点部位接触到水，在装入电池前，将对讲机和电池的电池触点擦干净并晾干。残留的水分会导致对讲机短路。
 - 如果对讲机被浸没在腐蚀性液体中（例如盐水），用清水将对讲机和电池冲洗干净，然后将对讲机和电池凉干。
 - 清洁对讲机的外部表面时，请使用中性餐洗剂和清水的稀释溶液（例如一茶匙餐洗剂和一加仑水）。
 - 切勿刺戳位于电池触点下方的对讲机壳上的孔（洞）。该孔能够使对讲机内的压力保持平衡。如果刺戳该孔，液体会渗漏进对讲机，可能会导致对讲机丧失防水性能。
- 切勿堵塞或覆盖该孔，即使使用标签。
 - 确保不让油泥接触到该孔。
 - 配备有适当天线的对讲机所设计的防水性能为：最大防水深度为 1 米（3.28 英尺），最长浸没时间为 30 分钟。越过最大限值或不使用天线可能会导致对讲机损坏。
 - 清洁对讲机时，禁止使用高压喷水，因为其压力会大于 1 米深的水压并可能会导致水渗漏进对讲机。

基本操作

本章介绍了使用对讲机的入门操作。

打开对讲机

按照步骤打开对讲机。

按住开/关按钮。

如果成功：

- 将发出一声提示音。
- LED 绿灯亮起。
- 显示屏显示 MOTOTRBO (TM)，然后显示欢迎信息或图像。
- 主屏幕亮起。

如果禁用“提示音/提示”功能，则开机时没有提示音。

如果对讲机没有开机，请检查电池。确定电池已充电并正确安装。如果对讲机仍没有开机，请与经销商联系。

关闭对讲机

按照步骤关闭对讲机。

按住**开/关**按钮。

对讲机可能最多需要七秒钟才能完全关闭。

显示屏将显示关机。

调节音量

按照步骤更改对讲机音量。

执行以下操作之一：

- 顺时针旋转**开/关/音量控制旋钮**提高音量。
- 逆时针旋转**开/关/音量控制旋钮**降低音量。



说明：

对讲机可通过预设来设置最低音量补偿，这种情况下音量无法降低至所设置的最低音量以下。请联系您的经销商或系统管理员了解详情。

对讲机控件

本章介绍了控制对讲机的按钮和功能。

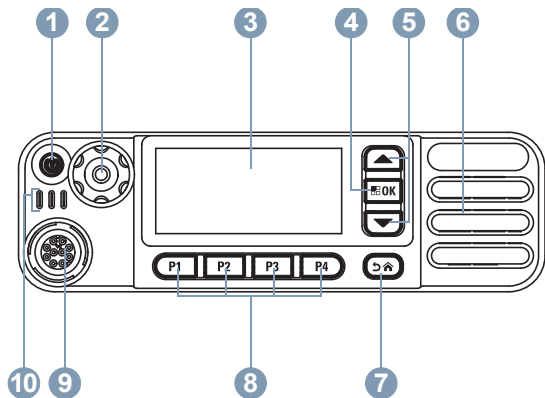

- 1 开/关/信息按钮
- 2 音量/信道旋钮
- 3 显示
- 4 菜单/确定按钮
- 5 向上/下滚动键
- 6 扬声器
- 7 返回/主屏幕按钮

8 正面可预设按钮

9 附件接口



10 LED 指示灯

音量/信道旋钮

可将**音量/信道旋钮**预设为用于调节音量和信道的双用途控制旋钮或预设为仅用于调节音量的控制旋钮。







要调节音量，请参阅[调节音量 \(第 26 页\)](#)。

要更改信道，请按住**音量/信道旋钮**直到显示信道选择状态。旋转**音量/信道旋钮**选择信道。执行以下步骤之一以退出信道选择状态：

- 按**音量/信道旋钮**。
- 按 。
- 按 。
- 等待菜单计时器过期。



设置双用旋钮操作首选项



按照步骤设置对讲机的双用旋钮操作首选项。

- 1 按  访问菜单。
- 2 按  或  显示设置。按  进行选择。
- 3 按  或  显示对讲机设置。按  进行选择。



键盘麦克风按钮

您可以使用四向导航键盘麦克风（Motorola Solutions 部件号：RMN5127_）上的 3 x 4 字母数字键盘访问对讲机的功能。许多字符需要您按一个键若干次。下表显示了要得到所需字符需要按下按键的次数。







按键	按键次数												
	1	2	3	4	5	6	7	8	9	10	11	12	13
	1	。	,	?	!	@	&	'	%	—	:	*	#
	甲	乙	C	2									







- 4 按  或  显示双用旋钮。按  进行选择。

屏幕显示仅音量和音量和信道。

- 5 按  或  显示所需的设置。按  进行选择。

所选设置旁边会出现 。屏幕将返回上一级菜单。

按键	按键次数												
	1	2	3	4	5	6	7	8	9	10	11	12	13
 3	D	E	F	3									
 4	G	H	I	4									
 5	J	K	L	5									
 6	M	N	O	6									
 7	P	问	R 表 示	S	7								
 8	T	充电器	V	8									
 9	W	X	Y	Z	9								

按键	按键次数												
	1	2	3	4	5	6	7	8	9	10	11	12	13
	0		说明: 按以输入“0”，长按激活大写锁定。再次长按关闭大写锁定。										
	* 或 删除		说明: 输入文本时，按下该键删除字符。输入数字时，按此键输入“*”。										
	# 或 空格		说明: 输入文本时，按此键插入一个空格。输入数字时，按此键输入“#”。										

WAVE

广域语音环境 (WAVE™) 提供在两个或更多对讲机之间发起呼叫的新方法。

WAVE 允许您使用 Wi-Fi 跨不同设备和网络进行通信。对讲机通过 Wi-Fi 连接到 IP 网络时，将发起 WAVE 呼叫。



您的对讲机支持不同的系统配置：

- WAVE OnCloud/OnPremise
- WAVE Tactical/5000

每个系统类型发起 WAVE 呼叫的方法不同。请根据对讲机的系统配置，参阅相应的部分。

表 1: WAVE 显示图标

启用 WAVE 时，显示屏上将短暂显示以下图标。





	WAVE 已连接 WAVE 已连接。
	WAVE 断开连接 WAVE 断开连接。



说明：
此功能仅适用于特定型号。

WAVE OnCloud/OnPremise

从对讲机模式切换到 WAVE 模式

- 1 执行以下操作之一：
 - 按预设的 **WAVE** 按钮。跳过以下步骤。
 - 按  访问菜单。
-
- 2 按  或  显示 WAVE。按  进行选择。

黄色 LED 指示灯双闪。

显示屏显示瞬时通知正在换到 WAVE，然后显示正在准备 WAVE。



说明：
切换到 WAVE 模式后，对讲机会自动启用 Wi-Fi。

如果成功：

- 闪烁的黄色 LED 指示灯熄灭。

- 显示屏显示“WAVE 已连接”图标、<通话组别名> 和 <信道索引>。

如果失败：

- 设备会发出一声否定提示音。
- 红色 LED 闪烁。
- 显示屏显示“WAVE 已断开”图标和无连接或激活：失败，具体取决于错误类型。



说明：

当将新设置更新到对讲机后，会进行同步。当进入 WAVE 模式时，对讲机会显示正在同步...。当同步完成后，对讲机会返回到主屏幕。

发起 WAVE 组呼

1 使用信道选择器旋钮/按钮选择 WAVE 通话组。

2 按 **PTT 键**发起呼叫。

如果成功，显示屏将显示“组呼”图标和 WAVE 通话组别名。

如果失败：

- 发出一声否定提示音。

- 显示屏显示瞬时通知呼叫失败或无参与者。

接收和响应 WAVE 组呼

当您接收 WAVE 组呼时：

- 将发出一声提示音。
- 显示屏显示组呼图标、WAVE 通话组别名和呼叫方别名。
- 对讲机取消静音，呼入电话会通过扬声器发出声音。

1 按 **PTT** 来回复该呼叫。

2 释放 **PTT** 按钮接听。

接收和响应 WAVE 单呼

当您接收 WAVE 单呼时：

- 将发出一声提示音。
- 显示屏显示单呼图标和呼叫方别名。
- 对讲机取消静音，呼入电话会通过扬声器发出声音。



1 按 **PTT** 来回复该呼叫。

2 释放 **PTT** 按钮接听。

从 WAVE 模式切换到对讲机模式

1 执行以下操作之一：

- 按预设的**对讲机模式**按钮。跳过以下步骤。
- 按  访问菜单。

2 按  或  显示对讲机模式。按  进行选择。

黄色 LED 指示灯双闪。

显示屏显示瞬时通知正在切换到对讲机，然后显示正在准备对讲机。

当成功时：

- 闪烁的黄色 LED 指示灯熄灭。
- 状态栏中的“WAVE 已连接”图标消失。显示屏显示 <通话组别名> 和 <信道索引>。

WAVE Tactical/5000



设置活动 WAVE 信道









说明：

WAVE 信道可通过 CPS 设置。进入 WAVE 信道后，对讲机会自动启用 Wi-Fi 并登录到 WAVE 服务器。

1 按  访问菜单。

2 按  或  显示 WAVE 信道。按  进行选择。



3 按  或  显示所需的 WAVE 信道。按  进行选择。



4 按  或  显示设为活动。按  进行选择。



显示屏在所选信道旁边显示 。

查看 WAVE 信道信息

- 1 执行以下操作之一：
 - 按预设的 **WAVE 信道列表** 按钮。跳过以下步骤。
 - 按  访问菜单。

- 2 按  或  显示 WAVE 信道。按  进行选择。

- 3 按  或  显示所需的 WAVE 信道。按  进行选择。

- 4 按  或  显示查看详情。按  进行选择。



显示屏显示 WAVE 信道详情。

查看 WAVE 端点信息

- 1 执行以下操作之一：
 - 按预设的 **联系人** 按钮。跳到 [步骤 3](#)。

- 按  访问菜单。

- 2 按  或  显示端点。按  进行选择。

- 3 按  或  显示所需的 WAVE 端点。按  进行选择。



- 4 按  选择查看详情。



显示屏显示 WAVE 端点详情。

更改 WAVE 配置

按照步骤设置 WAVE 服务器 IP 地址、用户 ID 和密码。

- 1 按  访问菜单。

- 2 按  或  显示设置。按  进行选择。

- 3 按  或  显示对讲机设置。按  进行选择。

- 按  或  显示 WAVE。按  进行选择。
- 按  以选择服务器地址。按  以更改服务器地址。按  进行选择。
- 按  以显示用户 ID。按  以更改用户 ID。按  进行选择。
- 按  以显示密码。按  以查看或更改 WAVE 密码。按  进行选择。
- 按  以显示应用。按  以应用所做的所有更改。

在返回对讲机设置屏幕之前，显示屏短暂显示确定性的小型通知。

发起 WAVE 组呼

- 选择具有所需组别名或 ID 的 WAVE 信道。

- 按 **PTT 键**发起呼叫。

LED 绿灯亮起。第一行文字显示**组呼**图标和别名。
第二行文字显示 **WAVE** 组别名。

- 执行以下操作之一：

- 等通话许可提示音结束后（启用该功能时）对着麦克风清楚地讲话。
- 等**通话按键**侧音结束后（启用该功能时）对着麦克风清楚地讲话。

- 释放 **PTT** 按钮接听。

当目标对讲机做出响应时，LED 绿灯亮起。显示屏显示**组呼**图标、别名或 ID，以及发射对讲机别名或 ID。

- 如果启用“信道空闲提示”功能，则当发射对讲机释放 **PTT** 时，您将会听到一声短的提示音，表示此信道空闲，您可以应答。按 **PTT** 来回复该呼叫。

在预定时间内无语音活动时，呼叫结束。对讲机将返回至发起呼叫前的屏幕。

Capacity Max 操作

Capacity Max 是基于控制信道的集群对讲机系统。本章说明对讲机用户在本系统中可以使用的功能。

通话按键 (PTT)

PTT 按钮有两个基本用途。

- 正在进行呼叫时，PTT 按钮可让对讲机向该呼叫中的其他对讲机发射信号。按下 PTT 按钮时，可激活麦克风。
- 当不进行呼叫时，PTT 按钮用于发起一次新呼叫。

按住**通话按键**进行通话。释放 PTT 按钮接听。

如果启用了通话许可提示音或**通话按键**侧音，则等待短提示音结束后即可开始通话。

如果您的对讲机激活了“信道空闲提示”功能（经销商进行了预设），则当目标对讲机（接收您呼叫的对讲机）释放**通话按键**时，您将会听到一声短提示音，表示此信道空闲，等待您的回答。

如果呼叫中断（例如，当对讲机接收到紧急呼叫时），您将听到一声连续的通话禁止提示音。您应释放 PTT 按钮。

可预设按钮

根据按下按钮的持续时间，您的经销商可将可预设按钮设置为对讲机功能的快捷键。

短按

快速按下并释放。

长按

按住然后保持预设的时间。



说明：

请参阅**紧急操作 (第 339 页)**详细了解**紧急呼叫**按钮的预设持续时间。

可分配的对讲机功能

可通过您的经销商或系统管理员将以下对讲机功能分配到可编程的按钮。

音频环境

允许用户选择对讲机的工作环境。

音频配置文件

允许用户选择首选音频配置文件。

蓝牙® 音频切换

在内部对讲机扬声器和已启用蓝牙功能的外部附件之间切换音频路由。

蓝牙连接

启动蓝牙查找并连接操作。

蓝牙断开

终止您的对讲机和任何已启用蓝牙的设备之间的所有现有蓝牙连接。

蓝牙可发现

使对讲机进入蓝牙可发现模式。

通讯录

用于直接访问通讯录列表。

呼叫提示

提供对通讯录列表的直接访问，以便您选择一个联系人并向其发送呼叫提示。

通话记录

选择通话记录列表。

紧急呼叫

根据预设，发起或取消紧急呼叫。

外部公共广播 (PA)

在已连接的 PA 扬声器放大器和对讲机内部 PA 系统之间切换音频路由。

重置主信道

设置新的主信道。

静音主信道提醒

静音主信道提醒。

室内定位

打开或关闭室内定位。

智能音频

打开或关闭智能音频。

手动拨号

通过键入任何用户 ID 发起单呼。

手动站点漫游

启动手动站点搜索。

麦克风 AGC

打开或关闭内部麦克风自动增益控制 (AGC) 功能。

通知

提供对通知列表的直接访问。

单键接入

直接启动预定义的广播呼叫、单呼、电话呼叫或组呼、呼叫提示或预制短信。

选件板功能

在支持选件板功能的信道上打开或关闭选件板功能。

电话

用于直接访问电话通讯录列表。

加密

打开或关闭加密。

公共广播 (PA)

打开或关闭对讲机内部 PA 系统。

对讲机别名和 ID

提供对讲机别名和 ID。

远程监听

开启目标对讲机的麦克风，而不点亮任何指示灯。

站点信息

显示当前 Capacity Max 站点名称和 ID。

启用语音提示时，播放当前站点的站点提示语音消息。

站点锁定

切换为打开时，对讲机只搜索当前站点。切换为关闭时，对讲机将搜索当前站点和其他站点。

遥感遥测控制

控制本地或远程对讲机上的输出引脚。

短信

选择短信菜单。

切换呼叫优先级

让对讲机可以进入呼叫优先级高/正常状态。

颤音增强功能

打开或关闭颤音增强功能。

语音提示开/关

打开或关闭语音提示。

信道语音提示

播放当前信道的区域和信道语音通知信息。禁用语音提示时此功能不可用。

Wi-Fi

打开或关闭 Wi-Fi。

区域选择

允许从区域列表中选择。

可分配的设置或实用功能

可将以下对讲机设置或实用功能分配到可编程的按钮。

音调/提示

打开或关闭全部音调和提示。

背光

打开或关闭屏幕背光。

信道上调/下调

根据预设，将信道切换至上一信道或下一信道。

显示模式

在日间/夜间显示模式之间进行切换。

电量级别



在高低功率之间切换发射功率级别。

访问预设的功能

按照步骤访问对讲机中预设的功能。

1 执行以下操作之一：

- 按预设的按钮。继续 [步骤 3](#)。
- 按  访问菜单。

2 按  或  显示菜单功能，然后按  选择功能或进入子菜单。

3 执行以下操作之一：

- 按  返回前一屏幕。
- 长按  返回主屏幕。

一段时间不活动后对讲机将自动退出菜单并返回主屏幕。

键盘麦克风上也可使用菜单导航按钮。请参阅[键盘麦克风按钮 \(第 28 页\)](#)。

状态指示灯



本章介绍对讲机中使用的状态指示灯和音频提示音。

图标

对讲机的液晶显示屏 (LCD) 显示对讲机状态、文本条目和菜单条目。

表 2: 显示屏图标

以下图标出现在对讲机显示屏顶部的状态栏中。图标按出现或使用顺序排列在最左侧，并为信道特定图标。

	<p>仅 BeiDou 可用¹ 已启用仅 BeiDou 功能。定位可用时，该图标亮起。</p>
	<p>蓝牙已连接 蓝牙功能已启用。当连接了一个远程蓝牙设备时，此图标将保持亮起状态。</p>

¹ 仅适用于 XiR M8660i/XiR M8668i/CM7668i。

	未连接蓝牙 蓝牙功能已启用，但尚未连接远程蓝牙设备。
	DGNA 对讲机处于 DGNA 通话组中。
	紧急呼叫 对讲机处于紧急呼叫模式。
	GNSS 可用 GNSS 功能已启用。定位可用时，该图标亮起。
	GNSS 不可用 GNSS 功能已启用，但未接收到卫星数据。
	大批量数据 对讲机正在接收大批量数据，信道处于繁忙状态。
	室内定位可用² 室内定位状态已打开并可用。

	室内定位不可用² 室内定位状态已打开但不可用，这是因为蓝牙已禁用或信标扫描通过蓝牙挂起。
	静音模式 静音模式已启用，扬声器已静音。
	通知 通知列表中有一个或多个错过的事件。
	选件板 选件板已启用。（仅已激活选件板的机型）
	选件板不工作 选件板已禁用。
	无线编程延迟计时器 表示自动重新启动对讲机之前剩余的时间。
	优先级 1 表示通话组的优先级为 1。

² 仅适用于具有最新软件和硬件的型号。

	优先级 2 表示通话组的优先级为 2。
	接收信号强度指示器 (RSSI) 显示的信号强度柱数目表示对讲机信号强度。四个信号强度柱表示信号的强度最强。只有在接收时才显示该图标。
	响应抑制 响应抑制已启用。
	仅响铃 已激活铃声模式。
	安全 加密功能已启用。
	共享频率 指示对讲机正锁定到共享控制信道。
	静音 已激活静音模式。

	站点漫游 已启用站点漫游功能。
	状态 表示有一则新的状态消息。
	提示音禁用 提示音已关闭。
	不安全 加密功能已禁用。
	Wi-Fi 极佳³ Wi - Fi 信号极佳。
	Wi-Fi 良好³ Wi-Fi 信号良好。
	Wi-Fi 中等³ Wi-Fi 信号中等。
	Wi-Fi 较差³ Wi-Fi 信号弱。

³ 仅适用于 XiR M8668i/CM7668i。



表 3: 高级菜单图标

以下图标显示在菜单项旁边，这些图标供用户在两个选项之间进行选择或者向用户表明有一个可提供两个选项的子菜单。

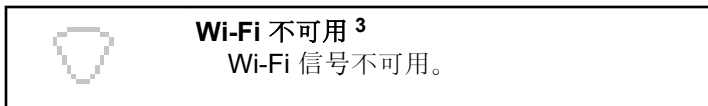

	<p>复选框 (选中) 表示已选择选项。</p>
	<p>复选框 (未选中) 表示未选择选项。</p>
	<p>实心黑框 表示为包含子菜单的菜单项所选择的选项。</p>

表 4: 蓝牙设备图标

以下图标显示在可用的已启用蓝牙功能的设备列表中的列表项旁边，用于指示设备类型。









	<p>蓝牙音频设备 已启用蓝牙功能的音频设备，例如耳机。</p>
	<p>蓝牙数据设备 已启用蓝牙功能的数据设备，例如扫描器。</p>
	<p>蓝牙 PTT 设备 已启用蓝牙功能的 PTT 设备，例如仅具备 PTT 功能的设备 (POD)。</p>

表 5: 呼叫图标

以下图标在呼叫过程中出现在显示屏上。这些图标也出现在通讯录列表中，表示别名或 ID 类型。







	<p>蓝牙 PC 呼叫 表示正在进行蓝牙 PC 呼叫。 在“通讯录”列表中，它表示蓝牙 PC 呼叫别名 (名称) 或 ID (编号)。</p>
	<p>呼叫优先级高 指示“呼叫优先级高”已启用。</p>

	DGNA 呼叫 表示正在进行 DGNA 呼叫。
	调度呼叫 调度呼叫联系人类型用于通过第三方短信服务器给调度员 PC 发送短信。
	组呼/全呼 表示正在进行组呼或全呼。 在“通讯录”列表中，它表示通话组别名（名称）或 ID（编号）。
	单呼 表示正在进行单呼。 在“通讯录”列表中，它表示用户别名（名称）或 ID（编号）。
	组呼/全呼电话呼叫 表示正在进行组呼或全呼电话呼叫。 在“通讯录”列表中，它表示通话组别名（名称）或 ID（编号）。
	单呼电话呼叫 表示正在进行“单呼电话呼叫”。

在“通讯录”列表中，它表示电话别名（名称）或 ID（编号）。

表 6: 任务图标

以下图标会短暂显示在显示屏的“任务”文件夹中。

	所有作业 表示已列出所有作业。
	新作业 表示已列出新作业。
	进行中 作业正在传输。这是会在“任务发送失败”或“发送成功”指示前看到。
	发送失败 作业无法发送。
	发送成功 作业已成功发送。
	优先级 1 表示作业的优先级 1。



	优先级 2 表示作业的优先级 2。
	优先级 3 表示作业的优先级 3。

表 7: 小型通知图标

在采取执行任务的操作后，显示屏上会短暂显示以下图标。



	发射失败（否定） 操作执行失败。
	发射成功（确定） 操作执行成功。
	正在发射（发射中） 正在发射。在指示发射成功或发射失败时显示。

表 8: 已发信息图标

以下图标显示在显示屏右上角的已发信息文件夹中。

	或		进行中 至某一用户别名或 ID 的短信正在等待发送，然后等待确认。 至某一通话组别名或 ID 的短信正在等待发送。
	或		已读单条或群组信息 已读短信。
	或		未读单条或群组信息 短信未读。
	或		发送失败 短信无法发送。
	或		发送成功 短信已经成功发送。

LED 指示灯

LED 指示灯显示对讲机的工作状态。

呈红色闪烁

开机后对讲机自检失败。

对讲机正在接收紧急发射信号。

对讲机正在低电池电量状态下发射。

如果配置了自动范围应答机系统，对讲机已移至范围以外。

已启用静音模式。

稳定绿色

对讲机正在开机。

对讲机正在传输信号。

对讲机正在发送呼叫提示或紧急呼叫传输。

呈绿色闪烁

对讲机正在接收呼叫或数据。

对讲机正在通过无线检索无线编程传输信号。

对讲机正在通过无线检测活动。



说明:

由于数字协议的特性，此活动可能会也可能不会影响对讲机的预设信道。

绿灯双闪

对讲机正在接收加密呼叫或数据。

稳定黄色

对讲机处于蓝牙可发现模式。

呈黄色闪烁

对讲机尚未响应呼叫提示。

黄灯双闪

对讲机已启用自动漫游功能。

对讲机正在主动搜索新站点。

对讲机尚未响应组呼提示。

对讲机被锁定。

提示音

以下是通过对讲机扬声器发出的提示音。



高音调提示音



低音调提示音

音频提示音

音频提示音通过声音向您发出有关对讲机状态或对讲机对所接收的数据进行的响应的提示。

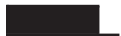

连续音

发出单调音。连续发音直至终止。



周期音

根据对讲机设定的持续时间周期发音。铃音自我启动、停止和重复。



重复音

自我重复的单音，直至用户将其终止。



瞬间音

根据对讲机设定的短持续时间发出一次。

提示音

在采取执行任务的操作后，提示音为您提供状态的声音提示。



确定提示音



否定提示音

注册

您可接收很多与注册相关的消息。

正在注册

通常，在开机期间、通话组更改期间或站点漫游过程中，会将注册发送到系统。如果对讲机在站点上注册失败，对讲机将自动尝试漫游到其他站点。对讲机暂时从漫游列表中删除它尝试过注册的站点。

指示意味着对讲机正忙于搜索要漫游的站点，或该对讲机已成功找到站点，但在等待对讲机注册消息的响应。

当正在注册显示在对讲机上时，对讲机会发出提示音并且LED黄灯双闪，以指示站点搜索。

如果指示始终显示，用户应该更改位置，或如果允许，手动漫游至其他站点。

Out of Range

当对讲机无法从系统或当前站点检测到信号时，对讲机被视为不在信号区。通常，此指示意味着对讲机超出地理出站射频 (RF) 覆盖范围。

当对讲机上出现超出范围时，将发出重复的提示音且红色 LED 闪烁。

如果对讲机在处于较好 RF 覆盖的区域仍接收到不在信号区指示，请联系您的经销商或系统管理员。

通话组加入失败

对讲机尝试加入注册过程中在信道或统一旋钮位置 (UKP) 中指定的通话组。

加入通话组失败的对讲机无法与该对讲机尝试加入的通话组之间发起或接收呼叫。

当对讲机加入通话组失败时，主屏幕上会出现 UKP 别名以及突出显示的背景。

如果对讲机接收到加入失败指示，请联系您的经销商或系统管理员。

注册被拒

当系统不接受注册时，将接收到注册被拒提示。

对讲机不向对讲机用户指明注册被拒的具体原因。通常，当系统操作员禁用对讲机对系统的访问时，注册会被拒。

当对讲机注册被拒时，对讲机上会显示注册被拒并且 LED 黄灯双闪，以指示站点搜索。

区域和信道选择



本章介绍了在对讲机上选择区域或信道的操作。

对讲机最多可预设 250 个 Capacity Max 区域，且每个区域最多 160 个信道。每个 Capacity Max 区域最多包含 16 个可分配的位置。每个 Capacity Max 区域最多包含 16 个可分配的位置。



选择区域

按照步骤在对讲机上选择所需的区域。

- 1 执行以下操作之一：
 - 按预设的**区域选择**按钮。继续 [步骤 3](#)。
 - 按  访问菜单。
-

- 按  或  显示区域。按  进行选择。

显示屏显示  和当前区域。



- 按  或  显示所需区域。按  进行选择。

显示屏短暂显示<区域> 已选择，然后返回所选区域屏幕。

使用别名搜索选择区域

按照步骤使用别名搜索在对讲机上选择所需的区域。

- 按  访问菜单。
-

- 按  或  显示区域。按  进行选择。

显示屏显示  和当前区域。

- 输入所需别名的第一个字符。

显示屏显示一个闪烁的光标。

- 输入所需别名的其余字符。

别名搜索不区分大小写。如果有两个或两个以上名称相同的条目，对讲机将显示列表中首先列出的条目。

第一行文字显示您输入的字符。接下来的几行文字显示筛选后的搜索结果。

- 按  进行选择。

显示屏短暂显示<区域> 已选择，然后返回所选区域屏幕。

选择呼叫类型

使用信道选择旋钮选择呼叫类型。呼叫类型可以是组呼、广播呼叫、全呼或单呼，具体取决于对讲机的预设情况。如果更改信道选择旋钮到另一个位置（已分配一个呼叫类型），这样会导致对讲机在 **Capacity Max** 系统重新注册。对讲机使用新信道选择旋钮位置呼叫类型预设的通话组 ID 注册。

由于选定未预设的信道时对讲机不工作，所以需要使用时道选择旋钮选择预设的信道。

所需区域显示后（如果对讲机中有多个区域），转动预设的信道选择旋钮以选择呼叫类型。

选择站点

站点会覆盖特定区域。在多站点网络中，Capacity Max 对讲机会在当前站点的信号等级降低至无法接受的等级时自动搜索新站点。

Capacity Max 系统支持多达 250 个站点。

漫游请求

漫游请求会使对讲机搜索其他站点，即使当前站点的信号可接受。

如果无站点可用：

- 对讲机将显示正在搜寻并继续搜索站点列表。
- 如果以前的站点仍可用，对讲机将返回上一个站点。



说明：

该功能已由经销商进行预设。

按预设的**手动站点漫游**按钮。

您将听到提示音，表示对讲机已切换到新站点。显示屏显示站点 ID <站点编号>。

站点锁定开/关

切换为打开时，对讲机只搜索当前站点。切换为关闭时，对讲机将搜索当前站点和其他站点。

按预设的**站点锁定**按钮。

如果**站点锁定**功能切换为开启：

- 您将听到确定提示音，表示对讲机已锁定到当前站点。
- 屏幕显示站点已锁定。

如果**站点锁定**功能切换为关闭：

- 您会听到否定提示音，表示对讲机已解锁。
- 屏幕显示站点已解锁。

站点限制

在 Capacity Max 系统中，您的对讲机管理员能够确定允许对讲机使用和不允许对讲机使用的网络站点。

对讲机无需重新预设即可更改允许和不允许站点列表。如果对讲机尝试在不允许的站点注册，对讲机将接收到站点被拒的提示。然后对讲机会搜索其他网络站点。

遇到站点限制时，对讲机显示注册被拒并且 LED 黄灯双闪，以指示站点搜索。

站点集群

站点必须能够与要被视为系统集群的集群控制器通信。

如果站点无法与系统中的集群控制器通信，对讲机将进入“站点集群”模式。处于“站点集群”模式时，对讲机将定期向用户提供声音和视觉指示，以便向用户告知功能受限。

当对讲机处于“站点集群”模式时，对讲机显示站点集群并且将发出重复提示音。

处于“站点集群”模式的对讲机仍然能够发起组呼和个人语音呼叫，并向同一站点中的其他对讲机发送短信。语音控制台、登记记录、电话网关和数据应用程序无法与该站点的对讲机进行通信。

处于“站点集群”模式后，参与多个站点呼叫的对讲机将仅能与位于同一站点中的其他对讲机进行通信。与其他站点之间进行的通信将丢失。



说明：

如果有多个站点覆盖对讲机的当前位置，并且其中一个站点进入“站点集群”模式，则对讲机将漫游到覆盖范围内的另一个站点。

呼叫

本章介绍了接收、回复、发出和停止呼叫的操作。

在使用以下一种功能选择了信道后，您可以选择一个用户别名或 ID、或通话组别名或 ID：

别名搜索

此方法用于仅使用键盘麦克风的组呼、单呼和全呼。

通讯录列表

此方法用于直接访问通讯录列表。

手动拨号（使用通讯录）

此方法用于仅使用键盘麦克风的单呼和电话呼叫。

预设的数字键

此方法用于仅使用键盘麦克风的组呼、单呼和全呼。



说明：

一个数字键只能分配有一个别名或 ID，但您可以使多个数字键与一个别名或 ID 相关联。可以分配键盘麦克风上的所有数字键。有关详细信息，请参阅[将条目分配至可编程数字键](#)（第 327 页）。

预设的单键接入按钮

此方法仅用于组呼、单呼和电话呼叫。

通过短按或长按可预设的按钮，您只能将一个 ID 分配给一个单键接入按钮。对讲机可以有多个预设的单键接入按钮。

可预设按钮

此方法仅用于电话呼叫。

音量/信道选择旋钮

此方法可手动选择用户别名或 ID、或通话组别名或 ID。

当对讲机发射时 LED 绿灯长亮，对讲机接收时为绿灯闪烁。



说明：

当对讲机发射时 LED 绿灯长亮，对讲机接收加密呼叫时指示灯的状态为绿灯双闪。

要对加密呼叫进行解密，您的对讲机必须拥有与发射对讲机（您从其接收呼叫的对讲机）相同的加密密钥，或相同的密钥值和密钥 ID（经销商进行了预设）。

有关详细信息，请参阅[加密 \(第 369 页\)](#)。

组呼

您的对讲机必须配置为通话组的一部分，才能从用户通话组接收呼叫或向用户通话组发起呼叫。

发起组呼

要发起对用户组的呼叫，对讲机必须配置为属于该通话组。按照步骤在对讲机上发起组呼。

1 执行以下操作之一：

- 选择具有活动通话组别名或 ID 的信道。请参阅[选择呼叫类型 \(第 48 页\)](#)。
 - 按预设的**单键接入**按钮。
-

2 按 **PTT** 键发起呼叫。

LED 绿灯亮起。第一行文字显示**组呼**图标和别名。

3 执行以下操作之一：

- 等通话许可提示音结束后（启用该功能时）对着麦克风清楚地讲话。
 - 等 **PTT** 侧音结束后（启用该功能时）对着麦克风清楚地讲话。
-

4 释放 **PTT** 按钮接听。

当目标对讲机做出响应时，LED 绿灯亮起。显示屏显示**组呼**图标、别名或 ID，以及发射对讲机别名或 ID。

5 如果启用“信道空闲提示”功能，则当发射对讲机释放 **PTT** 时，您将会听到一声短的提示音，表示此信道空闲，您可以应答。按 **PTT** 来回复该呼叫。

在预定时间内无语音活动时，呼叫结束。

呼叫发起者可按  以结束组呼。

使用通讯录列表发起组呼

按照步骤使用通讯录列表在对讲机上发起组呼。

- 1 按  访问菜单。
- 2 按  或  显示通讯录。按  进行选择。
- 3 按  或  显示所需的别名或 ID。按  进行选择。
- 4 按 **PTT** 键发起呼叫。
LED 绿灯亮起。
第一行显示用户别名或 ID。第二行显示组呼和组呼图标。
- 5 执行以下操作之一：
 - 等通话许可提示音结束后（启用该功能时）对着麦克风清楚地讲话。

- 等 **PTT** 侧音结束后（启用该功能时）对着麦克风清楚地讲话。

6 释放 **PTT** 按钮接听。

当组内任何用户回复时，LED 绿灯闪烁。显示屏显示组呼图标、别名或 ID，以及发射对讲机别名或 ID。

7 如果启用“信道空闲提示”功能，则当发射对讲机释放 **PTT** 时，您将会听到一声短的提示音，表示此信道空闲，您可以应答。按 **PTT** 来回复该呼叫。

在预定时间内无语音活动时，呼叫结束。

呼叫发起者可按  以结束组呼。

您将听见一声短提示音。屏幕显示呼叫结束。

使用可预设的数字键发起组呼

按照步骤使用可预设的数字键在对讲机上发起组呼。

1 在主屏幕上时，长按可预设的数字键显示预定义的别名或 ID。

如果将数字键分配至特定模式下的一个条目，当您在另一种模式下长按此数字键时，将无法支持该功能。

如果数字键未与条目相关联，会响起一声否定提示音。

2 按 **PTT** 键发起呼叫。

LED 绿灯亮起。

3 释放 **PTT** 按钮接听。

当组内任何用户回复时，LED 绿灯闪烁。

4 如果启用“信道空闲提示”功能，则当发射对讲机释放 **PTT** 时，您将会听到一声短的提示音，表示此信道空闲，您可以应答。按 **PTT** 来回复该呼叫。

在预定时间内无语音活动时，呼叫结束。对讲机返回到发起呼叫前您所在的屏幕。

呼叫发起者可按  以结束组呼。

有关详细信息，请参阅[将条目分配至可编程数字键 \(第 327 页\)](#)。

使用别名搜索发起组呼

您也可以使用别名或字母数字搜索来检索所需用户别名。本功能仅在通讯录中可用。按照步骤使用别名搜索发起呼叫。

1 按 访问菜单。

2 按 或 显示通讯录。按 进行选择。显示屏显示按字母顺序排列的条目。

3 按 或 显示所需的用户别名或 ID。屏幕第一行显示电话号码：。屏幕第二行显示闪烁的光标。使用键盘输入电话号码。

4 按 进行选择。如果选择的条目为空，对讲机会发出一声否定提示音，且显示屏显示电话号码无效。

5 按 或 显示“打电话”和按 进行选择。如果未在通讯录列表中预配置摘机码，则显示屏第一行显示摘机码：。屏幕第二行显示闪烁的光标。



输入摘机码，然后按  按钮继续。如果成功，DTMF 提示音响起。您将听到电话用户的拨号提示音。屏幕第一行显示用户别名或 ID 以及 RSSI 图标。屏幕第二行显示电话呼叫和“电话呼叫”图标。如果失败，将发出一声提示音，且屏幕显示打电话失败。对讲机返回到接入代码输入屏幕。如果在通讯录列表中

预配置了接入代码，则对讲机会返回到您发起呼叫之前所在的屏幕。

6 按 **PTT** 按钮进行通话，释放可接听。**RSSI** 图标会在传输期间消失。

7 要输入其他数字（如果电话呼叫要求），执行以下操作之一。

- 按任意键盘按键开始输入其他数字。显示屏第一行显示额外数字：。屏幕第二行显示闪烁的光标。输入其他数字，然后按  按钮继续。对讲机将发出 **DTMF** 提示音，然后返回到前一屏幕。
- 按 **单键接入** 按钮。**DTMF** 提示音将响起。如果 **单键接入** 按钮的输入为空，将响起一声否定提示音。

8 按  以结束通话。如果没有在通讯录列表中预配置取消接入代码，则屏幕第一行显示取消接入代码：。屏幕第二行显示闪烁的光标。输入取消接入代码，然后按  继续。对讲机返回到前一屏幕。对讲机发出 **DTMF** 提示音，且屏幕显示正在结束通话。如果成功，将发出一声提示音，且屏幕显示通话结束。对讲机将返回到电话呼叫屏幕。如果失败，对讲机将返回到电话呼叫屏幕。如果在电话通讯录屏幕中按 **PTT** 按钮，一声提示音响起，且屏幕显示按 **OK**

键发起呼叫。当电话用户结束呼叫时，一声提示音响起，且屏幕显示通话结束。如果在输入电话呼叫要求的其他数字时呼叫结束，对讲机返回至发起呼叫前的屏幕。



9 如果启用“信道空闲提示”功能，则当发射对讲机释放 **PTT** 时，您将会听到一声短的提示音，表示此信道空闲，您可以应答。按 **PTT** 来回复该呼叫。

在预定时间内无语音活动时，呼叫结束。将发出一声提示音。屏幕显示呼叫结束。

呼叫发起者可按  以结束组呼。



说明：

信道接入期间，按  可取消呼叫尝试并会发出一声提示音，或退出别名搜索。按  按钮或  退出别名搜索。通话期间，在预配置取消接入代码的情况下按 **单键接入** 按钮时，或在输入取消接入代码作为其他数字的输入时，对讲机均会尝试结束通话。在信道接入和摘机码/取消接入代码或其他数字传输期间，对讲机仅对开/关按钮、音量旋钮和信道选择按钮作出响应。每次无效输入均会发出提示音。

回复组呼

按照步骤在对讲机上回复组呼。

当您接收组呼时：

- LED 绿灯闪烁。
- 显示屏右上角显示**组呼**图标。
- 第一行文字显示呼叫方别名。
- 第二行文字显示组呼别名。
- 对讲机取消静音，呼入电话会通过扬声器发出声音。

1 执行以下操作之一：

- 如果启用“信道空闲提示”功能，则当发射对讲机释放 **PTT** 时，您将会听到一声短的提示音，表示此信道空闲，您可以应答。按 **PTT** 来回复该呼叫。
- 如果语音中断功能已启用，则按**通话按键**中止来自发射对讲机的音频，以释放信道供您做出应答。

LED 绿灯亮起。

2 执行以下操作之一：

- 等通话许可提示音结束后（启用该功能时）对着麦克风清楚地讲话。

- 等 **PTT** 侧音结束后（启用该功能时）对着麦克风清楚地讲话。

3 释放 **PTT** 按钮接听。

在预定时间内无语音活动时，呼叫结束。

广播呼叫

广播呼叫是从任何用户到整个通话组的单向语音呼叫。

广播呼叫功能仅允许呼叫发起用户传输至通话组，而呼叫接收者无法回复。

广播发起者还可结束广播呼叫。要接收来自用户组的呼叫或呼叫用户组，对讲机必须配置为属于该通话组。

发起广播呼叫

按照步骤在对讲机上发起广播呼叫。

1 执行以下操作之一：

- 选择具有活动通话组别名或 ID 的信道。请参阅[选择呼叫类型 \(第 48 页\)](#)。
- 按预设的**单键接入**按钮。

2 按 **PTT** 键发起呼叫。

LED 绿灯亮起。显示屏显示**组呼**图标和别名。

3 执行以下操作之一：

- 等通话许可提示音结束后（启用该功能时）对着麦克风清楚地讲话。
- 等 **PTT** 侧音结束后（启用该功能时）对着麦克风清楚地讲话。



呼叫发起者可按  以结束广播呼叫。

使用通讯录列表发起广播呼叫

按照步骤使用通讯录列表在对讲机上发起广播呼叫。

1 按  访问菜单。

2 按  或  显示通讯录。按  进行选择。

3 按  或  显示所需的别名或 ID。按  进行选择。

4 按 **PTT** 键发起呼叫。

LED 绿灯闪烁。

第一行显示用户别名或 ID。第二行显示组呼和**组呼**图标。

5 执行以下操作之一：

- 等通话许可提示音结束后（启用该功能时）对着麦克风清楚地讲话。
- 等 **PTT** 侧音结束后（启用该功能时）对着麦克风清楚地讲话。

呼叫发起者可按  以结束广播呼叫。

使用可预设的数字键发起广播呼叫

按照步骤使用可预设的数字键在对讲机上发起广播呼叫。

1 在主屏幕上时，长按可预设的数字键显示预定义的别名或 ID。

如果将数字键分配至特定模式下的一个条目，当您在另一种模式下长按此数字键时，将无法支持该功能。

如果数字键未与条目相关联，会响起一声否定提示音。

2 按 **PTT** 键发起呼叫。

LED 绿灯亮起。显示屏右上角显示**组呼**图标。第一行文字显示呼叫方别名。

3 执行以下操作之一：

- 等通话许可提示音结束后（启用该功能时）对着麦克风清楚地讲话。
- 等 **PTT** 侧音结束后（启用该功能时）对着麦克风清楚地讲话。

呼叫发起者可按  以结束广播呼叫。

接收广播呼叫

按照步骤在对讲机上接收广播呼叫。

当您接收广播呼叫时：

- LED 绿灯闪烁。
- 显示屏右上角显示**组呼**图标。
- 第一行文字显示呼叫方别名。
- 第二行文字显示组呼别名。
- 对讲机取消静音，呼入电话会通过扬声器发出声音。



说明：

接收用户在广播呼叫期间不允许使用对讲功能。显示屏显示对讲禁止。如果在广播呼叫期间按 **PTT** 按钮，会发出一声短暂的对讲禁止提示音。

单呼

单呼是由一台个体对讲机对另一台个体对讲机的呼叫。

有两种单呼设置方法。

- 第一种呼叫类型称为“非占空呼叫建立 (OACSU)”。**OACSU** 在执行对讲机存在检测后设置呼叫，并自动完成呼叫。
- 第二种类型称为“完全非占空呼叫建立 (FOACSU)”。**FOACSU** 也在执行对讲机存在检测后设置呼叫。但是，**FOACSU** 需要用户确认才可完成呼叫，且允许用户接受或拒绝呼叫。

呼叫类型由系统管理员配置。



说明：

呼叫发起者和接收者可通过按 ，以停止进行中的单呼。

发起单呼

您的对讲机必须经过预设才能发起单呼。如果未启用此功能，则当您发起呼叫时，您会听到一声否定提示音。按照步骤在对讲机上发起单呼。如果目标对讲机不可用，则发出一声短提示音且显示屏显示对方未应答。

- 1 执行以下操作之一：
 - 选择具有活动用户别名或 ID 的信道。请参阅[选择呼叫类型 \(第 48 页\)](#)。
 - 按预设的**单键接入**按钮。
- 2 按 **PTT 键**发起呼叫。
LED 绿灯亮起。显示屏显示**单呼**图标、用户别名和呼叫状态。
- 3 等通话许可提示音结束后（启用该功能时）对着麦克风清楚地讲话。
- 4 释放 **PTT 按钮**接听。
当目标对讲机做出响应时，LED 绿灯亮起。
- 5 在预定时间内无语音活动时，呼叫结束。您将听见一声短提示音。屏将显示呼叫结束。

呼叫发起者和接收者可通过按 ，以停止进行中的单呼。

使用可预设的数字键发起单呼

按照步骤使用可预设的数字键在对讲机上发起单呼。

- 1 在主屏幕上时，长按可预设的数字键显示预定义的别名或 ID。
如果将数字键分配至特定模式下的一个条目，当您在另一种模式下长按此数字键时，将无法支持该功能。
如果数字键未与条目相关联，会响起一声否定提示音。
- 2 按 **PTT 键**发起呼叫。
LED 绿灯亮起。显示屏右上角显示**单呼**图标。第一行文字显示呼叫方别名。第二行文字显示呼叫状态。
- 3 释放 **PTT 按钮**接听。
当目标对讲机做出响应时，LED 绿灯闪烁。屏幕显示目标别名。

- 4 在预定时间内无语音活动时，呼叫结束。您将听见一声短提示音。 屏幕显示呼叫结束。

呼叫发起者和接收者可通过按 ，以停止进行中的单呼。



有关详细信息，请参阅[将条目分配至可编程数字键 \(第 327 页\)](#)。

使用别名搜索发起单呼

- 1 按  访问菜单。
- 2 按  或  显示通讯录。按  进行选择。显示屏显示按字母顺序排列的条目。
- 3 按  或  至所需的用户别名或 ID。屏幕第一行显示电话号码：。屏幕第二行显示闪烁的光标。使用键盘输入电话号码。
- 4 按  进行选择。如果选择的条目为空，对讲机会发出一声否定提示音，且屏幕显示电话号码无效。

- 5 按  或  至“打电话”按  进行选择。如果未在通讯录列表中预配置摘机码，则屏幕第一行显示摘机码：。屏幕第二行显示闪烁的光标。输入摘机码，然后按  按钮继续。如果成功，DTMF 提示音响起。您将听到电话用户的拨号提示音。屏幕第一行显示用户别名或 ID 以及 **RSSI** 图标。屏幕第二行显示电话呼叫和**电话呼叫**图标。如果失败，将发出一声提示音，且屏幕显示打电话失败。对讲机返回到接入代码输入屏幕。如果在通讯录列表中预配置了摘机码，则对讲机会返回到您发起呼叫之前所在的屏幕。

- 6 按 **PTT** 按钮进行通话，释放可接听。**RSSI** 图标会在传输期间消失。
- 7 要输入其他数字（如果电话呼叫要求），执行以下操作之一。
 - 按任意键盘按键开始输入其他数字。显示屏第一行显示额外数字：。屏幕第二行显示闪烁的光标。输入其他数字，并按  按钮继续。对讲机将发出 **DTMF** 提示音，然后返回到前一屏幕。
 - 按**单键接入**按钮。DTMF 提示音将响起。如果**单键接入**按钮的输入为空，将响起一声否定提示音。



- 8 按  以结束通话。如果没有在通讯录列表中预配置取消接入代码，则屏幕第一行显示取消接入代码：。屏幕第二行显示闪烁的光标。输入取消接入代码，然后按  继续。对讲机返回到前一屏幕。对讲机发出 DTMF 提示音，且屏幕显示正在结束通话。如果成功，将发出一声提示音，且屏幕显示通话结束。对讲机将返回到电话呼叫屏幕。如果失败，对讲机将返回到电话呼叫屏幕。如果在电话通讯录屏幕中按 **PTT** 按钮，一声提示音响起，且屏幕显示按 **OK** 键发起呼叫。当电话用户结束呼叫时，一声提示音响起，且屏幕显示通话结束。如果在输入电话呼叫要求的其他数字时呼叫结束，对讲机返回至发起呼叫前的屏幕。

- 9 在预定时间内无语音活动时，呼叫结束。您将听见一声短提示音。屏幕显示呼叫结束。

呼叫发起者和接收者可通过按 ，以停止进行中的单呼。



说明：

信道接入期间，按  可取消呼叫尝试并会发出一声提示音，或退出别名搜索。按  按钮或  退出别名搜索。通话期间，在预配置取消接入代码的情况下按**单键接入**按钮时，或在输入取消接入代码作为其他数字的输入时，对讲机均会尝试结束通话。

使用单键呼叫按钮进行单呼

单键呼叫功能允许您轻松发起对预定义单呼别名或 ID 进行单呼。该功能可指定给可预设按钮的短按或长按操作。

您只能将一个别名或 ID 分配给单键呼叫按钮。对讲机可以有多个预设的单键呼叫按钮。

- 1 按预设的**单键呼叫**按钮对预定义的单呼别名或 ID 发起单呼。
- 2 按 **PTT** 键发起呼叫。
LED 绿灯长亮。
屏幕显示单呼别名或 ID。
- 3 等通话许可提示音结束后（启用该功能时）对着麦克风清楚地讲话。

4 释放 **PTT** 按钮接听。

当目标对讲机作出响应时，**LED** 绿灯闪烁。

如果在预定时间内无语音活动，则呼叫终止。

呼叫发起者和接收者可通过按 ，以停止进行中的单呼。

- 编辑之前拨叫的用户 ID，然后按  继续。

6 按 **PTT** 键发起呼叫。

LED 绿灯亮起。 屏幕显示目标别名。

7 等通话许可提示音结束后（启用该功能时）对着麦克风清楚地讲话。

8 释放 **PTT** 按钮接听。

当目标对讲机做出响应时，**LED** 绿灯亮起。 显示屏显示发送用户别名或 ID。

9 如果启用“信道空闲提示”功能，则当发射对讲机释放 **PTT** 时，您将会听到一声短的提示音，表示此信道空闲，您可以应答。按 **PTT** 来回复该呼叫。

在预定时间内无语音活动时，呼叫结束。 将发出一声提示音。 屏幕显示呼叫结束。

呼叫发起者和接收者可通过按 ，以停止进行中的单呼。

使用手动拨号发起单呼

按照步骤使用手动拨号在对讲机上发起单呼。

1 按 访问菜单。

2 按 或 显示通讯录。按 进行选择。

3 按 或 显示手动拨号。按 进行选择。

4 按 或 显示号码。按 进行选择。

5 执行以下操作之一：

- 输入用户 ID，然后按  继续。

接收单呼

当您接收配置为非占空呼叫建立 (OACSU) 的单呼时：

- LED 绿灯闪烁。
- 对讲机取消静音，呼入电话会通过扬声器发出声音。



说明：

根据对讲机配置情况，即 OACSU 或“完全非占空呼叫建立 (FOACSU)”，回复单呼可能需要也可能不需要用户确认。

对于 OACSU 配置，您的对讲机将取消静音并自动连接呼叫。

接受单呼

当您接收配置为完全非占空呼叫建立 (FOACSU) 的单呼时：

- LED 绿灯闪烁。
- 1 要接受配置为 FOACSU 的单呼，请执行以下一项操作：
 - 按  或  以接受，然后按  以应答单呼。

- 按任何条目上的 **PTT** 按钮。

LED 绿灯亮起。

- 2 等通话许可提示音结束后（启用该功能时）对着麦克风清楚地讲话。

- 3 释放 **PTT** 按钮接听。

在预定时间内无语音活动时，呼叫结束。将发出一声提示音。屏幕显示呼叫结束。



说明：



呼叫发起者和接收者可通过按 ，以停止进行中的单呼。

拒绝单呼

当您接收配置为完全非占空呼叫建立 (FOACSU) 的单呼时：

- LED 绿灯闪烁。

要拒绝配置为 FOACSU 的单呼，请执行以下一项操作：

- 按  或  以拒绝，然后按  以拒绝单呼。

- 按  拒绝单呼。

全呼

全呼是单个对讲机到站点上每个对讲机或站点组每个对讲机的呼叫，具体取决于系统配置。

全呼用于做出需要用户充分注意的重要通告。系统上的用户无法回复全呼。

Capacity Max 支持站点全呼和多站点全呼。系统管理员可在对讲机中配置其中一个或两个。



说明：

用户可支持系统范围内全呼，但 **Motorola Solutions** 基础设施不支持系统范围内全呼。

发起全呼

您的对讲机必须经过预设才能发起全呼。按照步骤在对讲机上发起全呼。

- 1 选择具有活动全呼通话组别名或 ID 的信道。请参阅 [选择呼叫类型 \(第 48 页\)](#)。

- 2 按 **PTT 键**发起呼叫。

LED 绿灯亮起。显示屏显示**组呼**图标和全呼、站点全呼或多站点呼叫中的任一项，具体取决于配置的类型。

- 3 执行以下操作之一：

- 等通话许可提示音结束后（启用该功能时）对着麦克风清楚地讲话。
- 等 **PTT** 侧音结束后（启用该功能时）对着麦克风清楚地讲话。

信道上的用户无法回复全呼。

呼叫发起者可按  以结束全呼。

使用可预设的数字键发起全呼

按照步骤使用可预设的数字键在对讲机上发起全呼。

- 1 在主屏幕上时，长按分配给预定义别名或 ID 的预设数字键。

如果将数字键分配至特定模式下的一个条目，当您在另一种模式下长按此数字键时，将无法支持该功能。

如果数字键未与条目相关联，会响起一声否定提示音。

2 按 PTT 键发起呼叫。

LED 绿灯亮起。显示屏显示**组呼**图标和全呼、站点全呼或多站点呼叫中的任一项，具体取决于配置的类型。

3 执行以下操作之一：

- 等通话许可提示音结束后（启用该功能时）对着麦克风清楚地讲话。
- 等 PTT 侧音结束后（启用该功能时）对着麦克风清楚地讲话。

呼叫发起者可按  以结束全呼。

有关详细信息，请参阅[将条目分配至可编程数字键 \(第 327 页\)](#)。

使用别名搜索发起全呼

1 按 访问菜单。

2 按 或 显示通讯录。按 进行选择。显示屏显示按字母顺序排列的条目。

3 按 或 至所需的用户别名或 ID。屏幕第一行显示电话号码：。屏幕第二行显示闪烁的光标。使用键盘输入电话号码。



4 按 进行选择。如果选择的条目为空，对讲机会发出一声否定提示音，且屏幕显示电话号码无效。

5 按 或 显示“打电话”。按 进行选择。如果没有在通讯录列表中预配置摘机码，则屏幕第一行将显示摘机码：。屏幕第二行显示闪烁的光标。输入摘机码，然后按 按钮继续。如果成功，DTMF 提示音响起。您将听到电话用户的拨号提示音。屏幕第一行显示用户别名或 ID 以及 RSSI 图标。屏幕第二行显示电话呼叫和“电话呼叫”图标。如果失败，将发出一声提示音，且屏幕显示打电话失败。对讲机返回到接入代码输入屏幕。如果在通讯录列表中预配置了接入代码，则对讲机会返回到您发起呼叫之前所在的屏幕。

6 按 **PTT** 按钮进行通话，释放可接听。RSSI 图标会在传输期间消失。

7 要输入其他数字（如果电话呼叫要求），执行以下操作之一。

- 按任意键盘按键开始输入其他数字。显示屏第一行显示额外数字：。屏幕第二行显示闪烁的光标。输入其他数字，并按  按钮继续。对讲机将发出 DTMF 提示音，然后返回到前一屏幕。
- 按**单键接入**按钮。DTMF 提示音将响起。如果**单键接入**按钮的输入为空，将响起一声否定提示音。

8 按  以结束通话。如果没有在通讯录列表中预配置取消接入代码，则屏幕第一行显示取消接入代码：。屏幕第二行显示闪烁的光标。输入取消接入代码，然后按  继续。对讲机返回到前一屏幕。对讲机发出 DTMF 提示音，且屏幕显示正在结束通话。如果成功，将发出一声提示音，且屏幕显示通话结束。对讲机将返回到电话呼叫屏幕。如果失败，对讲机将返回到电话呼叫屏幕。如果在电话通讯录屏幕中按 **PTT** 按钮，一声提示音响起，且屏幕显示按 OK 键发起呼叫。当电话用户结束呼叫时，一声提示音响起，且屏幕显示通话结束。如果在输入电话呼叫要求

的其他数字时呼叫结束，对讲机返回至发起呼叫前的屏幕。



说明：

呼叫发起者可按  以结束全呼。

接收全呼

当您接收全呼时，将发生以下情况：

- 将发出一声提示音。
- LED 绿灯闪烁。
- 显示屏右上角显示**组呼**图标。
- 第一行文字显示呼叫方别名 ID。
- 第二行文字显示全呼、站点全呼或多站点呼叫中的任一项，具体取决于配置的类型。
- 对讲机取消静音，呼入电话会通过扬声器发出声音。

在呼叫结束时，对讲机返回接收全呼前的屏幕。

如果启用“信道空闲提示”功能，则当发射对讲机释放**通话按键**时，您将会听到一声短提示音，表示此信道可供您使用。您无法回复全呼。



说明：

在接收全呼时，如果您切换至另一个信道，则对讲机停止接收该全呼。在全呼期间，您无法继续任何菜单导航或编辑，直至呼叫结束。

电话呼叫

电话呼叫是单个对讲机或一组对讲机与电话之间的呼叫。

根据对讲机的配置方式，可能提供也可能不提供以下功能：

- 双音多频 (DTMF) 提示音
- 取消接入代码
- 在接听电话呼叫时显示主叫方别名或 ID。
- 能够拒绝或接听电话呼叫

通过在该系统上分配和设置电话号码，可启用电话呼叫功能。咨询系统管理员以确定对讲机的预设情况。

发出电话呼叫

按照以下过程操作，在对讲机上发出电话呼叫。

- 1 按预设的**单键接入**按钮显示预设的别名或 ID。

如果**单键接入**按钮的输入为空，将响起一声否定提示音。

如果没有在通讯录列表中预配置摘机码，则显示屏显示摘机码：。

- 2 输入摘机码，然后按  继续。

摘机码或取消接入代码不可超过 10 个字符。

- 3 按 **PTT** 来回复该呼叫。

- 4 释放 **PTT** 按钮接听。

- 5 如果呼叫要求，应使用键盘输入其他数字，然后按  继续。

如果在输入呼叫要求的其他数字时呼叫结束，对讲机返回至发起呼叫前的屏幕。

DTMF 提示音将响起。对讲机返回到前一屏幕。

- 6 按  以结束通话。

- 7 执行以下操作之一：

- 如果未预配置取消接入代码，则在显示屏显示取消接入代码：时输入取消接入代码，然后按  继续。对讲机返回到前一屏幕。

- 按预设的**单键接入**按钮。如果**单键接入**按钮的输入为空，将响起一声否定提示音。

对讲机发出 **DTMF** 提示音，且屏幕显示正在结束通话。

如果呼叫成功结束：

- 将发出一声提示音。
- 屏幕显示呼叫结束。

如果呼叫无法结束，对讲机将返回到电话呼叫屏幕。重复后两个步骤或等待电话用户结束呼叫。

如果呼叫设置成功：

- DTMF** 提示音将响起。
- 您将听到电话用户的呼叫等待提示音。
- 显示屏显示**电话呼叫**图标、用户别名或 ID、电话呼叫和呼叫状态。



如果呼叫设置失败：

- 将发出一声提示音。
- 显示屏显示电话呼叫失败。
- 对讲机返回到接入代码输入屏幕。如果在通讯录列表中预配置了接入代码，则对讲机会返回到您发起呼叫之前所在的屏幕。

使用可预设按钮进行电话呼叫

按照步骤使用可预设按钮进行电话呼叫。

1 按预设的**电话**按钮进入电话条目列表。

2 按  或  显示所需的别名或 ID。按  进行选择。

如果未在“通讯录”列表中预配置摘机码，则显示屏显示摘机码：。输入摘机码，然后按  按钮继续。

LED 绿灯亮起。显示屏显示**电话呼叫**图标、用户别名或 ID 和呼叫状态。

3 按 **PTT** 按钮开始讲话。释放 **PTT** 按钮接听。RSSI 图标会在传输期间消失。

4 要输入额外数字（如果电话呼叫要求）：执行以下操作之一：

- 按任意键盘按键开始输入其他数字。显示屏显示额外数字：和闪烁的光标。输入其他数字，并按  按钮继续。对讲机将发出 **DTMF** 提示音，然后返回到前一屏幕。

- 按**单键接入**按钮。DTMF 提示音将响起。如果**单键接入**按钮的输入为空，将响起一声否定提示音。

5 按 以结束通话。

如果未在“通讯录”列表中预配置取消接入代码，则显示屏显示取消接入代码：。输入取消接入代码，然后按  按钮继续。

对讲机发出 DTMF 提示音，且屏幕显示正在结束通话。

如果结束通话设置成功，将发出一声提示音且显示屏显示通话结束。

如果结束通话设置不成功，您的对讲机将返回到电话呼叫屏幕。

如果在“电话通讯录”屏幕中按 **PTT** 按钮，一声提示音响起，且显示屏显示按 **OK** 键发起呼叫。

当电话用户结束呼叫时，一声提示音响起，且屏幕显示通话结束。

如果在输入电话呼叫要求的其他数字时呼叫结束，对讲机返回至发起呼叫前的屏幕。



说明：





信道接入期间，按  可取消呼叫尝试并会发出一声提示音。



通话期间，在预配置取消接入代码的情况下按**单键接入**按钮时，或在输入取消接入代码作为其他数字的输入时，对讲机均会尝试结束通话。

在信道接入和接入代码/取消接入代码或额外数字传输期间，对讲机仅对**开/关按钮**、**音量开/关音量旋钮**和**信道上调/下调信道选择按钮**作出响应。每次无效输入均会发出提示音。

使用通讯录列表发出电话呼叫

按照步骤使用通讯录列表在对讲机上发出电话呼叫。

- 1 按  访问菜单。
- 2 按  或  显示通讯录。按  进行选择。
显示屏显示按字母顺序排列的条目。



3 按  或  显示所需的别名或 ID。按  进行选择。

处于“电话通讯录”屏幕上时，如果按 **PTT** 按钮：

- 发出一声否定提示音。
- 显示屏显示按 **OK** 键发起呼叫。

如果选定的条目为空：

- 发出一声否定提示音。
- 显示屏显示电话呼叫无效 #。

4 按  或  显示打电话。按  进行选择。
如果未预配置摘机码，显示屏显示摘机码：

5 输入摘机码，然后按  继续。

摘机码或取消接入代码不可超过 10 个字符。

显示屏显示正在呼叫、用户别名或 ID 和 **电话呼叫** 图标。

如果呼叫成功：

- **DTMF** 提示音将响起。
- 您将听到电话用户的呼叫等待提示音。

- 显示屏显示用户别名或 ID、**电话呼叫** 图标和电话呼叫。

如果呼叫失败：

- 将发出一声提示音。
- 显示屏显示电话呼叫失败，然后显示摘机码：。
- 如果已在通讯录列表中预配置了摘机码，对讲机将返回到发起呼叫前您所在的屏幕。

6 按 **PTT** 来回复该呼叫。
RSSI 图标消失。

7 释放 **PTT** 按钮接听。

8 如果呼叫要求，应使用键盘输入其他数字，然后按  继续。

如果在输入呼叫要求的其他数字时呼叫结束，对讲机将返回到发起呼叫前您所在的屏幕。

DTMF 提示音将响起。对讲机返回到前一屏幕。

9 按  以结束通话。

10 如果未预配置取消接入代码，则在显示屏显示取消接

入代码：时输入取消接入代码，然后按  继续。

对讲机返回到前一屏幕。对讲机发出 DTMF 提示音，且屏幕显示正在结束通话。

如果呼叫成功结束：

- 将发出一声提示音。
- 屏幕显示呼叫结束。

如果呼叫无法结束，对讲机将返回到电话呼叫屏幕。

重复 [步骤 9](#) 和 [步骤 10](#)，或等待电话用户结束呼叫。

如果在“电话通讯录”屏幕中按 PTT 按钮，一声提示音响起，且显示屏显示按 OK 键发起呼叫。

当电话用户结束呼叫时，一声提示音响起，且屏幕显示通话结束。

如果在输入电话呼叫要求的其他数字时呼叫结束，对讲机返回至发起呼叫前的屏幕。

**说明：**







信道接入期间，按  可取消呼叫尝试并会发出一声提示音。

通话期间，在预配置取消接入代码的情况下按 **单键接入按钮**时，或在输入取消接入代码作为其他数字的输入时，对讲机均会尝试结束通话。

在信道接入和摘机码/取消接入代码或其他数字传输期间，对讲机仅对 **开/关按钮**、**音量旋钮**和**信道选择按钮**作出响应。每次无效输入均会发出提示音。

使用别名搜索发出电话呼叫

您也可以使用别名或字母数字搜索来检索所需用户别名。本功能仅在通讯录中可用。按照步骤使用别名搜索在对讲机上发出电话呼叫。

- 1 按  访问菜单。
- 2 按  或  显示通讯录。按  进行选择。显示屏显示按字母顺序排列的条目。
- 3 按  或  显示所需的用户别名或 ID。

4 按  进行选择。如果选择的条目为空，对讲机会发出一声否定提示音，且屏幕显示电话号码无效。

5 按  或  显示打电话。按  进行选择。

如果未在“通讯录”列表中预配置摘机码，则显示屏显示摘机码：和闪烁的光标。输入摘机码，然后按

 按钮继续。

如果成功：

- DTMF 提示音将响起。
- 您将听到电话用户的呼叫等待提示音。
- 显示屏显示用户别名或 ID、RSSI 图标、电话呼叫和电话呼叫图标。

如果失败：

- 将发出一声提示音。
- 显示屏显示电话呼叫失败。
- 对讲机返回到接入代码输入屏幕。如果在通讯录列表中预配置了接入代码，则对讲机会返回到您发起呼叫之前所在的屏幕。

6 按 **PTT** 按钮进行通话，释放可接听。**RSSI** 图标会在传输期间消失。

7 要输入其他数字（如果电话呼叫要求），执行以下操作之一。

- 按任意键盘按键开始输入其他数字。显示屏显示额外数字：和闪烁的光标。输入其他数字，然后按  按钮继续。DTMF 提示音将响起
- 按**单键接入**按钮。DTMF 提示音将响起。如果**单键接入**按钮的输入为空，将响起一声否定提示音，并且对讲机会返回到前一屏幕。

8 按  以结束通话。

如果未在“通讯录”列表中预配置取消接入代码，则显示屏显示取消接入代码：和闪烁的光标。输入取消接入代码，然后按  继续。

对讲机返回到前一屏幕。对讲机发出 DTMF 提示音，且屏幕显示正在结束通话。

如果成功：

- 将发出一声提示音。
- 屏幕显示通话结束。



- 对讲机将返回到电话呼叫屏幕。

如果失败：

- 对讲机将返回到电话呼叫屏幕。
- 如果在电话通讯录屏幕中按 **PTT** 按钮，一声提示音响起，且屏幕显示按 **OK** 键发起呼叫。
- 当电话用户结束呼叫时，一声提示音响起，且屏幕显示通话结束。
- 如果在输入电话呼叫要求的其他数字时呼叫结束，对讲机返回至发起呼叫前的屏幕。



说明：

信道接入期间，按  可取消呼叫尝试并会发出一声提示音，或退出别名搜索。按  按钮或  退出别名搜索。通话期间，在预配置取消接入代码的情况下按 **单键接入** 按钮时，或在输入取消接入代码作为其他数字的输入时，对讲机均会尝试结束通话。在信道接入和摘机码/取消接入代码或其他数字传输期间，对讲机仅对开/关按钮、音量旋钮和信道选择按钮作出响应。每次无效输入均会发出提示音。

使用手动拨号发出电话呼叫

按照步骤使用手动拨号在对讲机上发出电话呼叫。

- 1 按  访问菜单。
- 2 按  或  显示通讯录。按  进行选择。
- 3 按  或  显示手动拨号。按  进行选择。
- 4 按  或  显示电话号码。按  进行选择。
显示屏显示号码：和一个闪烁的光标。
- 5 输入电话号码，然后按  继续。
如果未预配置摘机码，显示屏显示摘机码：和一个闪烁的光标。
- 6 输入摘机码，然后按  继续。摘机码或取消接入代码不可超过 **10** 个字符。
LED 绿灯亮起。显示屏显示 **电话呼叫** 图标、用户别名和呼叫状态。
如果呼叫成功：

- DTMF 提示音将响起。
- 您将听到电话用户的呼叫等待提示音。
- 显示屏显示用户别名和**电话呼叫**图标。

如果呼叫失败：

- 将发出一声提示音。
- 显示屏显示电话呼叫失败，然后显示摘机码：。
- 如果已在通讯录列表中预配置了摘机码，对讲机将返回到发起呼叫前您所在的屏幕。

- 将发出一声提示音。
- 屏幕显示呼叫结束。

如果呼叫无法结束，对讲机将返回到电话呼叫屏幕。重复 [步骤 7](#) 或等待电话用户结束呼叫。

7 按  以结束通话。

8 执行以下操作之一：

- 如果未预配置取消接入代码，则在显示屏显示取消接入代码：时输入取消接入代码，然后按  继续。对讲机返回到前一屏幕。
- 按预设的**单键接入**按钮。如果**单键接入**按钮的输入为空，将响起一声否定提示音。

对讲机发出 DTMF 提示音，且屏幕显示正在结束通话。

如果呼叫成功结束：



说明:

如果在“电话通讯录”屏幕中按 **PTT** 按钮，一声提示音响起，且显示屏显示按 **OK** 键发起呼叫。

电话用户结束通话时，会发出一声提示音且显示屏显示呼叫结束。

如果在输入电话呼叫要求的其他数字时呼叫结束，对讲机返回至发起呼叫前的屏幕。

信道接入期间，按  可取消呼叫尝试并会发出一声提示音。

通话期间，在预配置取消接入代码的情况下按 **单键接入** 按钮时，或在输入取消接入代码作为其他数字的输入时，对讲机均会尝试结束通话。

在信道接入和摘机码/取消接入代码或其他数字传输期间，对讲机仅对**开/关按钮**、**音量旋钮**和**信道选择按钮**作出响应。每次无效输入均会发出提示音。

双音多频

双音多频 (DTMF) 功能使对讲机可以在与电话系统有接口连接的对讲机系统中工作。

您可以通过禁用所有对讲机提示音和提示来关闭 DTMF 提示音。有关详细信息，请参阅[打开或关闭对讲机音调/提示](#) (第 161 页)。

发起 DTMF 呼叫

按照步骤在对讲机上发起 DTMF 呼叫。

- 1 按住 **PTT** 按钮。
-
- 2 执行以下操作之一：
 - 输入所需号码发起 DTMF 呼叫。
 - 按  发起 DTMF 呼叫。
 - 按  发起 DTMF 呼叫。
-

回复全呼电话呼叫

当您接收全呼电话呼叫时，接收对讲机无法对讲或回复。接收用户也不允许结束全呼。

当您收到全呼电话呼叫时：

- 显示屏右上角显示**电话呼叫**图标。

- 显示屏将显示全呼、站点全呼或多站点呼叫中的任一项，具体取决于配置的类型和电话呼叫。
- LED 绿灯闪烁。
- 对讲机取消静音，呼入电话会通过扬声器发出声音。

回复组呼电话呼叫

按照步骤在对讲机上回复组呼电话呼叫。

当您收到组呼电话呼叫时：

- 显示屏显示**电话呼叫**图标和电话呼叫。
- LED 绿灯闪烁。
- 对讲机取消静音，呼入电话会通过扬声器发出声音。

1 按 **PTT** 来回复该呼叫。

2 释放 **PTT** 按钮接听。

3 按  以结束通话。



说明：

对讲机无法作为组呼终止电话呼叫。电话用户必须结束通话。接收用户只能在呼叫过程中使用对讲功能。

显示屏显示通话结束中。

如果呼叫成功结束：

- 将发出一声提示音。
- 屏幕显示呼叫结束。

如果呼叫无法结束，对讲机将返回到电话呼叫屏幕。重复**步骤 3**或等待电话用户结束呼叫。

回复单呼电话呼叫

按照步骤在对讲机上回复单呼电话呼叫。

当您收到单呼电话呼叫时：

- 显示屏显示**电话呼叫**图标和电话呼叫。
- LED 绿灯闪烁。
- 对讲机取消静音，呼入电话会通过扬声器发出声音。

1 按 **PTT** 来回复该呼叫。

2 释放 **PTT** 按钮接听。

3 按  以结束通话。



说明:

对讲机无法作为组呼终止电话呼叫。电话用户必须结束通话。接收用户只能在呼叫过程中使用对讲功能。

显示屏显示通话结束中。

如果呼叫成功结束：

- 将发出一声提示音。
- 屏幕显示呼叫结束。

如果呼叫无法结束，对讲机将返回到电话呼叫屏幕。重复 **步骤 3** 或等待电话用户结束呼叫。

较高优先级的呼叫（如紧急呼叫或全呼）抢占发射对讲机，以适应较高优先级的呼叫。若无其他可用射频 (RF) 信道，紧急呼叫也会抢占全呼。

语音中断

语音中断允许用户关闭进行中的语音传输。

如果中断对讲机配置为“语音中断”，且发射对讲机配置为“语音呼叫可中断”，此功能使用反向信道信令来停止进行中的语音传输。然后，允许中断对讲机对停止呼叫中的参与方进行语音传输。

“语音中断”功能显著提高了在正在进行呼叫时成功向目标方进行新传输的可能性。

仅在对讲机设置此功能时，用户才可访问“语音中断”。请联系您的经销商或系统管理员了解详情。

启用语音中断

按照步骤在对讲机上发起语音中断。

您的对讲机必须进行预设才允许您使用该功能。请联系您的经销商或系统管理员了解详情。

- 1 要在正在进行的呼叫过程中中断传输，请按下**通话按键**。

呼叫抢占

呼叫抢占可允许对讲机终止正在进行中的语音传输，且启动优先传输。

通过呼叫抢占功能，系统可在到集群信道不可用的情况下中断并抢占正在进行的呼叫。

在被中断呼叫的对讲机上，屏幕会显示呼叫中断。对讲机将发出一声否定提示音，直至释放**通话按键**。

2 等待确认。

如果成功：

- 发出一声确定提示音。

如果失败：

- 发出一声否定提示音。

3 执行以下操作之一：

- 等通话许可提示音结束后（启用该功能时）对着麦克风清楚地讲话。
- 等 **PTT** 侧音结束后（启用该功能时）对着麦克风清楚地讲话。

高级功能

本章介绍对讲机中可用的功能的操作。

您的经销商或系统管理员可能已经针对您的具体需要对对讲机进行了定制。请联系您的经销商或系统管理员了解详情。

呼叫排队

如果无可用资源处理呼叫，呼叫排队功能可将呼叫请求置于系统队列中，以便等待下个可用资源。

按下 **PTT** 按钮后，您将听到一声呼叫排队提示音，且对讲机屏幕显示呼入队列，这表示对讲机已进入“呼叫排队”状态。听到呼叫排队提示音后，可松开 **PTT** 按钮。

如果呼叫设置成功，则会出现以下情况：

- LED 绿灯闪烁。
- 如果启用，将发出通话许可提示音。
- 屏幕显示呼叫类型图标、ID 或别名。
- 对讲机用户最多具有 **4** 秒时间按下 **PTT** 按钮，以开始语音传输。

如果呼叫设置失败，则会出现以下情况：

- 如果启用，将发出拒绝提示音。
- 屏幕会短暂显示失败通知屏幕。
- 呼叫终止，且对讲机退出呼叫设置。

优先呼叫

“优先呼叫”允许系统在所有信道都处于繁忙状态时，抢占正在进行的非优先呼叫之一并发起所请求的高优先级呼叫。

如果高优先级呼叫占用了所有信道，则系统不抢占任何呼叫，而是将请求高优先级呼叫置于呼叫队列中。如果系统未能将请求高优先级呼叫置于呼叫队列中，则会声明故障。

优先呼叫的默认设置可预先配置。按可预设按钮可在正常级别和高优先级之间切换。使用以下功能时，呼叫优先级将自动恢复为预配置的设置。

- 所有语音呼叫
- DMR III 短信/短信
- 任务
- 远程监听



说明：

咨询经销商或系统管理员以确定对讲机的预设情况。

下面是优先呼叫的类型：

高优先级

对讲机显示“下一个呼叫：高优先级”。

呼叫优先级高图标出现在对讲机显示屏的顶部。

语音提示会发出以下声音：“下一个呼叫：高优先级”。

正常优先级

对讲机显示“下一个呼叫：正常优先级”。

呼叫优先级高图标消失。

语音提示会发出以下声音：“下一个呼叫：正常优先级”。

通话组扫描

此功能允许对讲机监听并加入接收组列表中所定义的通话组的呼叫。

启用扫描时，扫描图标出现在状态栏中，且 LED 黄灯闪烁。您的对讲机将对其接收组列表中的所有成员取消静音。

禁用扫描后，对讲机将不会接收接收组列表任意成员的传输，全呼和选定通话组除外。



说明：



通话组扫描可以使用 CPS 配置。咨询系统管理员以确定对讲机的预设情况。

打开或关闭通话组扫描







按照步骤打开或关闭对讲机上的通话组扫描。

1

按  访问菜单。

2 按  或  显示扫描。按  进行选择。

3 执行以下操作之一：

- 按  或  显示打开。按  进行选择。
- 按  或  显示关闭。按  进行选择。

如果扫描已启用：

- 显示屏显示扫描开和**扫描**图标。
- 黄色 LED 指示灯闪烁。
- 发出一声确定提示音。

如果扫描被禁用：

- 显示屏显示扫描关。
- **扫描**图标消失。
- LED 熄灭。
- 发出一声否定提示音。

接收组列表

接收组列表是一项功能，使您可以创建和分配通话组扫描列表上的成员。

此列表在预设对讲机时创建，决定可扫描哪些组。您的对讲机最多支持此列表中的 **16** 个成员。

如果对讲机预设为编辑扫描列表，则可以：

- 添加/删除通话组。
- 添加、删除和/或编辑通话组的优先级。参见 [编辑通话组的优先级 \(第 80 页\)](#)。
- 添加、删除和/或编辑加入通话组。请参阅[添加通话组加入 \(第 81 页\)](#)和[删除通话组加入 \(第 82 页\)](#)。
- 使用新的扫描列表更换现有扫描列表。



重要说明：

要将成员添加至列表，必须首先在对讲机中配置通话组。



说明：

接收组列表由系统管理员进行预设。请联系您的经销商或系统管理员了解详情。

优先级监听

优先级监听功能允许对讲机在处于某个通话组呼叫中时自动接收具有更高优先级的通话组的传输。

对讲机将离开较低优先级的通话组呼叫，进入较高优先级的通话组呼叫。



说明:

此功能只能在启用通话组扫描功能时才可访问。

优先级监听功能仅适用于接收组列表中的成员。有两个优先级通话组：优先级 1 (P1) 和优先级 2 (P2)。P1 的优先级高于 P2。在 **Capacity Max** 系统中，对讲机将根据下列优先级顺序接收传输：

- 1 P1 通话组的紧急呼叫
- 2 P2 通话组的紧急呼叫
- 3 接收组列表中非优先级通话组的紧急呼叫
- 4 全呼
- 5 P1 通话组呼叫
- 6 P2 通话组呼叫
- 7 接收组列表中的非优先级通话组

请参阅[编辑通话组的优先级 \(第 80 页\)](#)，了解有关如何在扫描列表中添加、删除和/或编辑通话组优先级的更多信息。



说明:

此功能由系统管理员进行预设。请联系您的经销商或系统管理员了解详情。

编辑通话组的优先级

在通话组扫描菜单中，您可查看或编辑通话组的优先级。



- 1 按  访问菜单。



- 2 按  或  显示扫描。按  进行选择。

- 3 按  或  显示查看/编辑列表。按  进行选择。

- 4 按  或  显示所需的通话组。按  进行选择。
当前优先级由通话组旁边的**优先级 1** 或**优先级 2** 图标表示。

- 5 按  或  显示编辑优先级。按  进行选择。

- 6 按  或  显示所需的优先级。按  进行选择。

如果另一个通话组已分配至优先级 1 或优先级 2，则您可选择覆盖当前的优先级。当显示屏显示覆盖当前？，请按  或  显示以下选项：

- 否返回上一步。
- 是进行覆盖。

在返回上一个屏幕前，屏幕会显示确定性的小型通知。“优先级”图标显示在通话组旁边。

多通话组加入

在 Capacity Max 系统，您的对讲机在一个站点最多可配置七个通话组。

在接收组列表的 16 个通话组中，最多可将七个通话组分配为加入通话组。将自动加入选定通话组和优先级通话组。







说明：

此功能由系统管理员进行预设。请联系您的经销商或系统管理员了解详情。

添加通话组加入

按照步骤添加通话组加入。

- 1 按  访问菜单。
- 2 按  或  显示扫描。按  进行选择。
- 3 按  或  显示查看/编辑列表。按  进行选择。
- 4 按  或  显示所需的通话组 ID 或别名。按  进行选择。
加入状态显示在查看/编辑列表中。显示屏在已选通话组 ID 或别名旁边显示 。
- 5 按  或  显示编辑加入。按  进行选择。
- 6 执行以下操作之一：
 - 按  或  显示开。按  进行选择。

- 按  或  显示关。按  进行选择。选择开时， 将出现在通话组 ID 或别名旁边。

如果加入成功，则显示屏在已选通话组 ID 或别名旁边显示 。

如果加入失败，则  将保留在通话组 ID 或别名旁边。









说明：



在扫描列表中选择加入最大数量 7 个通话组时，对讲机将显示列表已满。要选择新的通话组加入，请删除现有已加入通话组，为新增通话组让出空间。有关详细信息，请参阅[删除通话组加入 \(第 82 页\)](#)。

删除通话组加入



加入列表已满且您想选择加入新的通话组时，可删除现有的已加入通话组，为新增通话组让出空间。按照步骤删除通话组加入。





- 1 按  访问菜单。
- 2 按  或  显示扫描。按  进行选择。

- 3 按  或  显示查看/编辑列表。按  进行选择。

- 4 按  或  显示所需的通话组 ID 或别名。按  进行选择。

加入状态显示在查看/编辑列表中。显示屏在已选通话组 ID 或别名旁边显示 。

- 5 按  或  显示编辑加入。按  进行选择。

- 6 按  或  显示关。按  进行选择。选择关闭时， 将从通话组 ID 或别名旁边消失。

对讲

对讲功能使您能够在扫描过程中响应传输。

如果对讲机通过在可选通话组扫描列表中扫描呼叫，且在扫描呼叫时按下**通话按键**，则对讲机的操作取决于在对讲机预设过程中对讲是否已启用或禁用。请联系您的经销商或系统管理员了解详情。

对讲已禁用

对讲机放弃扫描呼叫，转而尝试在当前所选信道位置对联系人发射信号。在当前所选联系人的呼叫闲置时间超时后，对讲机返回主信道，并启动扫描闲置时间计时器。对讲机在扫描闲置时间计时器超时后将恢复通话组扫描。

对讲已启用

如果在扫描呼叫的组呼闲置时间内按下**通话按键**，则对讲机尝试向扫描通话组发射信号。



说明：

如果扫描到未分配到当前选定区域信道位置的组呼叫并且呼叫结束，您需要切换到适当区域，然后选择组的信道位置以回复该组。

蓝牙

该功能允许您通过蓝牙连接将您的对讲机与启用了蓝牙功能的设备（附件）一起使用。您的对讲机支持 **Motorola Solutions** 提供的以及市场上出售 (COTS) 的带蓝牙功能的设备。

蓝牙的有效视线距离是 10 米 (32 英尺)。该距离是指您的对讲机与已启用蓝牙功能设备之间的无障碍距离。为了实现高度可靠性，**Motorola Solutions** 建议不要将对讲机和附件分开。

在信号接收范围的边缘区域，您所听到的语音和提示音可能会变得“含混不清”或“断断续续”。要解决这一问题，请将您的对讲机和启用了蓝牙功能的设备彼此靠近一些（使它们在规定的 10 米范围内），以便重新接收能够提供清晰音频的较强信号。对讲机的蓝牙功能在 10 米范围内的最大功率为 2.5 mW (4 dBm)。

您的对讲机最多可同时与三个不同类型的蓝牙设备建立蓝牙连接。例如，同时与一个耳机、一个扫描仪和一个仅具备 PTT 功能的设备 (POD) 连接。您的对讲机不支持同时与多个同一类型的设备建立蓝牙连接。

请参阅相应蓝牙设备的用户手册，以了解更多支持蓝牙设备的全部功能。











说明：

如果通过 CPS 禁用，所有蓝牙相关功能都将禁用，并且蓝牙设备数据库将被擦除。

打开和关闭蓝牙

按照步骤打开和关闭蓝牙。

- 1 按  访问菜单。
- 2 按  或  显示蓝牙。按  进行选择。

- 3 按  或  显示我的状态。按  进行选择。
- 屏幕显示开和关。当前状态通过  指示。
-







4 执行以下操作之一：

- 按  或  显示开。按  进行选择。显示屏在开旁边显示 。
 - 按  或  显示关。按  进行选择。显示屏在关旁边显示 。
-









连接到蓝牙设备

按照步骤连接至蓝牙设备。

打开您的蓝牙设备，并将其设置为配对模式。

- 1 按  访问菜单。
-
- 2 按  或  显示蓝牙。按  进行选择。
-
- 3 按  或  显示设备。按  进行选择。
-

4 执行以下操作之一：

- 按  或  显示所需的设备。按  进行选择。
 - 按  或  显示 查找设备以查找可用设备。按  或  显示所需的设备。按  进行选择。
-

5 按  或  显示连接。按  进行选择。

您的蓝牙设备可能需要您执行其他步骤以完成配对过程。有关详细信息，请参阅启用蓝牙设备的用户手册。

显示屏显示正在连接到 <设备>。

等待确认。

如果成功：

- 发出一声确定提示音。
- 显示屏显示<设备> 已连接和 **蓝牙已连接** 图标。
- 显示屏在已连接设备的旁边显示 。

如果失败：

- 发出一声否定提示音。

- 显示屏显示连接失败。



说明：

如果需要 PIN 代码，请参阅[使用密码访问对讲机](#) (第 147 页)。

连接至处于可发现模式下的蓝牙设备

按照步骤连接至处于可发现模式下的蓝牙设备。

打开您的蓝牙设备，并将其设置为配对模式。

- 1 按  访问菜单。
- 2 按  或  显示蓝牙。按  进行选择。
- 3 按  或  显示查找我。按  进行选择。现在，在预设的持续时间内，对讲机可以被其他支持蓝牙功能的设备找到。这就是“可发现模式”。

等待确认。

如果成功：

- 发出一声确定提示音。
- 显示屏显示<设备> 已连接和**蓝牙已连接**图标。
- 显示屏在已连接设备的旁边显示 。

如果失败：

- 发出一声否定提示音。
- 显示屏显示连接失败。

断开与蓝牙设备的连接

按照步骤断开蓝牙设备。

- 1 按  访问菜单。
- 2 按  或  显示蓝牙。按  进行选择。
- 3 按  或  显示设备。按  进行选择。
- 4 按  或  显示所需的设备。按  进行选择。
- 5 按  或  显示断开。按  进行选择。
显示屏显示正在与<设备>断开连接。



说明:

您的蓝牙设备可能需要您执行其他步骤以完成断开过程。请参阅启用蓝牙设备的相关用户手册。

等待确认。

- 将发出一声提示音。
- 显示屏显示<设备>已断开连接且**蓝牙已连接**图标消失。
- 已连接设备旁边的  消失。

在对讲机内部扬声器和蓝牙设备之间切换音频路由

按照步骤在对讲机内部扬声器和外部蓝牙设备之间切换音频路由。













按预设的**蓝牙音频切换**按钮。

屏幕将显示以下结果之一：

- 将发出一声提示音。显示屏显示将音频路由到对讲机。
- 将发出一声提示音。显示屏显示将音频路由到蓝牙。

查看设备详情

按照步骤在对讲机上查看设备详情。

- 1 按  访问菜单。
- 2 按  或  显示蓝牙。按  进行选择。
- 3 按  或  显示设备。按  进行选择。
- 4 按  或  显示所需的设备。按  进行选择。
- 5 按  或  显示查看详情。按  进行选择。

删除设备名称

您可从蓝牙设备列表中删除已断开连接的设备。

- 1 按  访问菜单。

- 2 按  或  显示蓝牙。按  进行选择。

- 3 按  或  显示设备。按  进行选择。



- 4 按  或  显示所需的设备。按  进行选择。



- 5 按  或  显示删除。按  进行选择。屏幕显示已删除设备。



蓝牙麦克风增益



此功能允许用户控制已连接的蓝牙功能设备的麦克风增益值。

- 1 按  访问菜单。

- 2 按  或  显示蓝牙。按  进行选择。

- 3 按  或  显示蓝牙麦克风增益。按  进行选择。

- 4 按  或  至蓝牙麦克风增益类型和当前值。按  进行选择。您可以在此处编辑值。

- 5 按  或  增加或减少值。按  进行选择。

室内定位



说明:









室内定位功能适用于具有最新软件和硬件的型号。请联系您的经销商或系统管理员了解详情。

室内定位用于跟踪对讲机用户的位置。启用室内定位时，对讲机处于受限制可发现模式。专用的信标用于定位对讲机并确定其位置。

打开或关闭室内定位

您可以通过执行以下操作之一打开或关闭室内定位。

- 通过菜单访问此功能。
 - a. 按  访问菜单。

- b. 按  或  至蓝牙，然后按  进行选择。
- c. 按  或  至室内定位，然后按  进行选择。
- d. 按  打开室内定位。
显示屏显示室内定位开。您会听到一声确定提示音。
会发生以下情况之一。
 - 如果成功，“室内定位可用”图标出现在主屏幕显示屏上。
 - 如果失败，显示屏显示打开失败。您会听到一声否定提示音。
- e. 按  关闭室内定位。
显示屏显示室内定位关。您会听到一声确定提示音。
会发生以下情况之一。
 - 如果成功，“室内定位可用”图标在主屏幕显示屏上消失。

- 如果失败，显示屏显示关闭失败。您会听到一声否定提示音。
- 使用预设按钮访问此功能。
 - a. 长按预设的**室内定位**按钮，打开室内定位。
显示屏显示室内定位开。您会听到一声确定提示音。
会发生以下情况之一。
 - 如果成功，“室内定位可用”图标出现在主屏幕显示屏上。
 - 如果失败，显示屏显示打开失败。如果失败，您将听到一声否定提示音。
 - b. 按预设的**室内定位**按钮，关闭室内定位。
显示屏显示室内定位关。您会听到一声确定提示音。
会发生以下情况之一。
 - 如果成功，“室内定位可用”图标在主屏幕显示屏上消失。
 - 如果失败，显示屏显示关闭失败。如果失败，您将听到一声否定提示音。

访问室内定位信标信息

按照步骤访问室内定位信标信息。

- 1 按  访问菜单。

- 2 按  或  至蓝牙，然后按  进行选择。

- 3 按  或  至室内定位，然后按  进行选择。

- 4 按  或  至信标，然后按  进行选择。

屏幕显示信标信息。

多站点控制

将当前对讲机信道配置为 **Capacity Max** 系统时，这些功能适用。

启动手动站点搜索

按照步骤在接收到的信号强度较差时启动手动站点搜索，以尝试查找信号更强的站点。

如果对讲机发现新站点：

- 发出一声确定提示音。

如果对讲机未找到新站点：

- 发出一声否定提示音。

站点锁定开/关

切换为打开时，对讲机只搜索当前站点。切换为关闭时，对讲机将搜索当前站点和其他站点。

按预设的**站点锁定**按钮。

如果**站点锁定**功能切换为开启：

- 您将听到确定提示音，表示对讲机已锁定到当前站点。
- 屏幕显示站点已锁定。

如果**站点锁定**功能切换为关闭：

- 您会听到否定提示音，表示对讲机已解锁。
- 屏幕显示站点已解锁。

访问邻域站点列表

此功能可允许用户查看当前主站点的邻近站点列表。按照步骤访问“邻域站点”列表：

- 1 按  访问菜单。

- 2 按  或  显示设置。按  进行选择。

- 3 按  或  显示对讲机信息。按  进行选择。

- 4 按  或  显示邻域站点。按  进行选择。

主信道提醒

此功能在对讲机一段时间内未设置为主信道时提供一个提醒。

如果启用了此功能，当对讲机一段时期内未设置为主信道时，将定期发生以下现象：

- 主信道提醒和提示音响起。
- 显示屏第一行显示无。

- 第二行显示主信道。

使主信道提醒静音

发出主信道提醒时，您可以暂时将提醒静音。



按**静音主信道提醒**预设按钮。



显示屏的第一行显示 HCR，第二行显示已设为静音。

设置新的主信道



发生主信道提醒时，您可以设置新的主信道。

- 1 执行以下操作之一：
 - 按**重置主信道**可预设按钮，以将当前信道设置为主信道。跳过以下步骤。
显示屏的第一行显示信道别名，第二行显示新主信道。
 - 按  访问菜单。

- 2 按  或  显示设置。按  进行选择。

3 按  或  显示对讲机设置。按  进行选择。

4 按  或  显示主信道。按  进行选择。

5 按  或  所需的新主信道别名。按  进行选择。

显示屏将在所选的主信道别名旁边显示 。

远程监听

此功能用于打开具有用户别名或 ID 的目标对讲机的麦克风。您可以使用该功能远程监听目标对讲机四周的任何声音活动。



您的对讲机和目标对讲机必须进行预设才允许您使用该功能。

如果已发起，目标对讲机上的绿色 LED 闪烁一次。在预设的持续时间后或者当目标对讲机上执行了任何用户操作时，该功能将自动停止。

开始远程监听

按照步骤在对讲机上启动远程监听。

1 按预设的**远程监听**按钮。

2 按  或  显示所需的别名或 ID。按  进行选择。

显示屏显示过渡性的小型通知，指示正在处理该请求。LED 绿灯亮起。

3 等待确认。

如果成功：

- 发出一声确定提示音。
- 显示屏显示确定性的小型通知。
- 开始在预设持续时间内播放来自被监听对讲机的音频，并且显示屏显示远程监听。计时器超时后，对讲机发出一声提示音，且 LED 指示灯熄灭。

如果失败：

- 发出一声否定提示音。
- 显示屏显示否定性的小型通知。

使用通讯录列表启动远程监听

按照步骤使用通讯录列表在对讲机上启动远程监听。

- 1 按  访问菜单。

- 2 按  或  显示通讯录。按  进行选择。

- 3 按  或  显示所需的别名或 ID。按  进行选择。

- 4 按  或  显示远程监听。按  进行选择。

显示屏显示过渡性的小型通知，指示正在处理该请求。LED 绿灯亮起。

- 5 等待确认。
如果成功：
 - 发出一声确定提示音。
 - 显示屏显示确定性的小型通知。

- 开始在预设时间内播放来自被监听对讲机的音频，并且显示屏显示远程监听。计时器超时后，对讲机发出一声提示音，且 LED 指示灯熄灭。

如果失败：

- 发出一声否定提示音。
- 显示屏显示否定性的小型通知。

使用手动拨号启动远程监听

按照步骤使用手动拨号在对讲机上启动远程监听。



- 1 按  访问菜单。



- 2 按  或  显示通讯录。按  进行选择。

- 3 按  或  显示手动拨号。按  进行选择。

- 4 按  或  显示对讲机号码。按  进行选择。

- 5 执行以下操作之一：

- 输入用户别名或 ID，然后按  继续。
- 编辑之前拨叫的 ID，然后按  继续。

- 6 按  或  显示远程监听。按  进行选择。

显示屏显示过渡性的小型通知，指示正在处理该请求。LED 绿灯亮起。

- 7 等待确认。

如果成功：

- 发出一声确定提示音。
- 显示屏显示确定性的小型通知。
- 开始在预设持续时间内播放来自被监听对讲机的音频，并且显示屏显示远程监听。计时器超时后，对讲机发出一声提示音，且 LED 指示灯熄灭。

如果失败：

- 发出一声否定提示音。
- 显示屏显示否定性的小型通知。

通讯录设置

对讲机上的通讯录提供地址簿功能。每个条目对应于一个用于启动呼叫的别名或 ID。条目按字母顺序排列。

根据上下文的不同，每个条目都会关联不同的呼叫类型：组呼、单呼、广播呼叫、站点全呼、多站点全呼、PC 呼叫或调度呼叫。

PC 呼叫和调度呼叫是与数据相关的。这两种呼叫只能与数据应用一起使用。有关详细信息，请参阅数据应用文档。

另外，通讯录菜单允许您将每个条目分配至键盘麦克风上一个或多个可预设数字键。如果在数字键上分配一个条目，您的对讲机可据此进行快速呼叫。



说明：

您会在每个被分配至某个条目的数字按钮之前看到一个复选标记。如果复选标记位于空置之前，则说明您未对该条目分配一个数字键。

通讯录中的每个条目会显示以下信息：

- 呼叫类型
- 呼叫别名
- 呼叫 ID

**说明：**

如果启用了某个信道上的加密功能，您就可以在此信道上发起加密组呼、单呼、全呼和电话呼叫。只有当目标对讲机和您的对讲机拥有相同的加密密钥或相同的密钥值和密钥 ID 时，才能对发射信号进行解密。

将条目分配至可编程数字键

按照步骤将条目分配至对讲机上的可编程数字键。

- 1 按  访问菜单。

- 2 按  或  显示通讯录。按  进行选择。

- 3 按  或  显示所需的别名或 ID。按  进行选择。



- 4 按  或  显示快捷键配置。按  进行选择。



- 5 执行以下操作之一：
 - 如果未将所需的数字键分配到一个条目，按  或  显示所需的数字键。按  进行选择。

- 如果已将所需的数字键分配到一个条目，显示屏显示当前键已被指定，然后第一行文本显示是否覆盖？。执行以下操作之一：

按  或  显示是。按  进行选择。

对讲机发出一声确定提示音，显示屏显示联系人已保存和确定性的小型通知。

按  或  显示否以返回上一步。

每个条目可以与不同的数字键相关联。您会在每个被分配至某个条目的数字键之前看到一个 。如果  在空置之前，表示该数字键未分配。

如果将数字键分配至特定模式下的一个条目，当您在另一种模式下长按此数字键时，将无法支持该功能。

屏幕自动返回上一级菜单。



删除条目和可编程数字键之间的关联



按照步骤在对讲机上删除条目和可编程数字键之间的关联。



- 1 执行以下操作之一：
 - 长按预设的数字键显示所需的别名或 ID。继续 [步骤 4](#)。



- 按  访问菜单。

2 按  或  显示通讯录。按  进行选择。

3 按  或  显示所需的别名或 ID。按  进行选择。

4 按  或  显示快捷键配置。按  进行选择。

5 按  或  显示空。按  进行选择。
第一行文字显示从所有按键中清除。

6 按  或  显示是。按  进行选择。

**说明:**



当条目被删除时，该条目与其预设数字键之间的关联将被取消。



发出一声确定提示音。显示屏显示联系人已保存。
屏幕自动返回上一级菜单。



添加新联系人

按照步骤在对讲机上添加新联系人。

1 按  访问菜单。



2 按  或  显示通讯录。按  进行选择。

3 按  或  显示新建联系人。按  进行选择。

4 按  或  以选择联系人类型对讲机联系人或电话联系人。按  进行选择。

5 用键盘输入联系人号码，然后按  继续。

6 用键盘输入联系人姓名，然后按  继续。

- 按  或  显示所需的铃声类型。按  进行选择。

发出一声确定提示音。显示屏显示确定性的小型通知。



呼叫提醒设置



此功能允许对讲机用户配置呼叫或短信铃声。



激活或停用单呼呼叫铃声

按照步骤在对讲机上激活或停用单呼呼叫铃声。

- 按  访问菜单。
- 按  或  显示设置。按  进行选择。
- 按  或  显示对讲机设置。按  进行选择。
- 按  或  显示音调/提示。按  进行选择。

- 按  或  显示呼叫铃声。按  进行选择。







- 按  或  显示单呼。按  进行选择。



- 按  或  显示所需的提示音。按  进行选择。



如果启用，已启用旁出现 。如果禁用，已启用旁的  消失。





激活或停用短信呼叫铃声





按照步骤在对讲机上激活或停用短信呼叫铃声。

- 按  访问菜单。
- 按  或  显示设置。按  进行选择。
- 按  或  显示对讲机设置。按  进行选择。

4 按  或  显示音调/提示。按  进行选择。

5 按  或  显示呼叫铃声。按  进行选择。



6 按  或  显示短信。按  进行选择。
显示屏显示  和当前提示音。



7 按  或  显示所需的提示音。按  进行选择。显示屏在所选提示音旁边显示 。

激活或停用呼叫提示的呼叫铃声



按照步骤在对讲机上激活或停用呼叫提示的呼叫铃声。



1 按  访问菜单。





2 按  或  显示设置。按  进行选择。

3 按  或  显示对讲机设置。按  进行选择。

4 按  或  显示音调/提示。按  进行选择。

5 按  或  显示呼叫铃声。按  进行选择。



6 按  或  显示呼叫提示。按  进行选择。



7 按  或  显示所需的提示音。按  进行选择。显示屏在所选提示音旁边显示 。



激活或停用选择呼叫的呼叫铃声



按照步骤在对讲机上激活或停用选择呼叫的呼叫铃声。





1 按  访问菜单。





2 按  或  显示设置。按  进行选择。

3 按  或  显示对讲机设置。按  进行选择。



4 按  或  显示音调/提示。按  进行选择。



5 按  或  显示呼叫铃声。按  进行选择。

6 按  或  显示选择呼叫。按  进行选择。
显示屏显示  和当前提示音。



7 按  或  显示所需的提示音。按  进行选择。显示屏在所选提示音旁边显示 。





1 按  访问菜单。

2 按  或  显示设置。按  进行选择。

3 按  或  显示对讲机设置。按  进行选择。

4 按  或  显示音调/提示。按  进行选择。

5 按  或  显示呼叫铃声。按  进行选择。

6 按  或  显示遥感遥测。按  进行选择。
当前提示音以  表示。

激活或停用带文本的遥感遥测状态的呼叫铃声

按照步骤在对讲机上激活或停用带文本的遥感遥测状态的呼叫铃声。

指定铃音类型

接收特定联系人的单呼、呼叫提示或短信时，可以将对讲机设置为发出 11 种预定义铃音中的任何一种。当您浏览该列

表时，对讲机播放各铃音类型的声音。按照步骤在对讲机上指定铃音类型。

- 1 按  访问菜单。

- 2 按  或  显示通讯录。按  进行选择。
 条目按字母顺序排列。

- 3 按  或  显示所需的别名或 ID。按  进行选择。

- 4 按  或  显示查看/编辑。按  进行选择。

- 5 按 ，直到显示屏显示铃声菜单
 一个 ✓ 指示当前所选提示音。

- 6 按  或  显示所需的提示音。按  进行选择。
 ✓ 所选提示音旁边会出现。

渐强警报音

对讲机可预设为当对讲机呼叫尚未回复时，不断提醒。这由警报音量随时间自动增强来实现。此功能称为渐强提示音。

呼叫记录功能

您的对讲机将记录所有近期的已拨呼叫、已接来电和未接单呼。使用呼叫记录功能查看和管理近期的呼叫。



“未接呼叫提示”可能包括在呼叫记录中，具体取决于对讲机上的系统配置。您可以在各呼叫列表中执行以下任务：



- 将别名或 ID 存储至通讯录
- 删除呼叫
- 删除所有呼叫
- 查看详情

查看最近呼叫

按照步骤在对讲机上查看最近呼叫。

- 1 按  访问菜单。

2 按  或  显示呼叫记录。按  进行选择。

3 按  或  显示首选列表。选项为未接呼叫、已接呼叫和已拨呼叫列表。

按  进行选择。

显示屏显示最近期的条目。



4 按  或  查看列表。



您可以按 **PTT** 按钮使用显示屏当前显示的别名或 ID 发起呼叫。



从呼叫列表存储别名或 ID



按照步骤从对讲机呼叫列表存储别名或 ID。

1 按  访问菜单。

2 按  或  显示呼叫记录。按  进行选择。

3 按  或  显示所需的列表。按  进行选择。

4 按  或  显示所需的别名或 ID。按  进行选择。



5 按  或  显示存储。按  进行选择。
显示屏显示一个闪烁的光标。



6 输入所需别名的其余字符。按  进行选择。
您可以存储无别名的 ID。
显示屏显示确定性的小型通知。

删除呼叫列表中的呼叫

按照步骤删除对讲机呼叫列表中的呼叫。



1 按  访问菜单。



2 按  或  显示呼叫记录。按  进行选择。

3 按  或  显示所需的列表。按  进行选择。





如果列表为空：

- 将发出一声提示音。
 - 显示屏显示列表为空。
-

4 按  或  显示所需的别名或 ID。按  进行选择。

5 按  或  显示删除条目？。按  进行选择。



6 执行以下操作之一：



- 按  选择是以删除该条目。
屏幕显示条目已删除。
 - 按  或  显示否。按  进行选择。
对讲机返回到前一屏幕。
-



删除呼叫列表中的全部呼叫



按照步骤删除对讲机呼叫列表中的全部呼叫。

1 按  访问菜单。





2 按  或  显示呼叫记录。按  进行选择。

3 按  或  显示所需的列表。按  进行选择。

4 按  或  显示所需的别名或 ID。按  进行选择。

5 按  或  显示全部删除。按  进行选择。

6 执行以下操作之一：

- 按  选择是以删除所有条目。
显示屏显示确定性的小型通知。
- 按  或  显示否。按  进行选择。

对讲机返回到前一屏幕。

查看呼叫列表中的详情

按照步骤查看对讲机呼叫列表中的详情。

- 1 按  访问菜单。
- 2 按  或  显示呼叫记录。按  进行选择。
- 3 按  或  显示所需的列表。按  进行选择。
- 4 按  或  显示所需的别名或 ID。按  进行选择。
- 5 按  或  显示查看详情。按  进行选择。
显示屏显示详细信息。

呼叫提醒操作

呼叫提醒使您可以提示一个具体的对讲机用户在可能的时间回呼您。

该功能仅适用于用户别名或 ID，并且可从菜单中使用通讯录、手动拨号或预设的**单键接入**按钮来访问。

在 **Capacity Max** 中，呼叫提示功能允许对讲机用户或调度员向其他对讲机用户发送提示，从而请求对讲机用户在可用时回拨发起呼叫的用户。此功能中未涉及语音通信。

呼叫提示操作可由经销商或系统管理员以下列两种方式配置：

- 对讲机配置为允许用户按 **PTT** 按钮，以通过发起单呼直接响应呼发起者。
- 对讲机配置为允许用户按 **PTT** 按钮，并继续进行其他通话组通信。在呼叫提示条目上按 **PTT** 按钮不会允许用户响应呼发起者。用户必须导航至“呼叫记录”菜单的“未接来电记录”选项，并在此处响应呼提示。

“非占空呼叫建立 (OACSU)”单呼允许用户立即响应，而“完全非占空呼叫建立 (FOACSU)”单呼需要用户确认呼。因此，建议将 OACSU 类型呼用于呼提示功能。请参阅**单呼** (第 57 页)。

发起呼叫提示

按照步骤在对讲机上发起呼叫提示。

1 按预设的单键接入按钮。

显示屏显示呼叫提示及用户别名或 ID。LED 绿灯亮起。

2 等待确认。

如果接收到呼叫提示确认，显示屏会显示确定性的小型通知。

如果未收到呼叫提示确认，显示屏会显示否定性的小型通知。

使用通讯录列表发起呼叫提示

按照步骤使用通讯录列表在对讲机上发起呼叫提示。

1 按 访问菜单。

2 按 或 显示通讯录。按 进行选择。

3 按 或 显示所需的别名或 ID。按 进行选择。

4 按 或 显示呼叫提示。按 进行选择。

显示屏显示呼叫提示及用户别名或 ID。LED 绿灯亮起。

5 等待确认。

- 如果接收到呼叫提示确认，显示屏会显示确定性的小型通知。
- 如果未收到呼叫提示确认，显示屏会显示否定性的小型通知。

对呼叫提示做出响应

按照步骤在对讲机上对呼叫提示做出响应。

当您接收呼叫提示时：

- 将发出一声重复音。
- 黄色 LED 指示灯闪烁。

- 显示屏显示出呼叫提示以及主叫对讲机别名或 ID 的通知列表。

您可以通过执行以下操作之一响应呼叫提示，具体取决于经销商或系统管理员的配置：

- 按 **PTT** 按钮并通过单呼直接回复呼叫方。
- 按 **PTT** 按钮继续进行正常的通话组通信。“呼叫提示”被移至“呼叫记录”菜单的“未接来电”选项。您可以从“未接来电记录”响应呼叫方。

有关详细信息，请参阅[通知列表 \(第 149 页\)](#)和[呼叫记录功能 \(第 99 页\)](#)。

静音模式

静音模式将为用户提供静音对讲机所有音频指示器的选项。

启用静音模式功能后，所有音频指示器都将静音，优先级更高的功能除外（如紧急呼叫操作）。

退出静音模式后，对讲机将恢复播放正在进行的提示音并恢复音频传输。



说明：

这是一项可购买功能。请联系您的经销商或系统管理员了解详情。

打开静音模式

按照以下步骤打开静音模式。

使用预设的**静音模式**按钮访问此功能。

启用静音模式时，将发生以下情况：

- 发出一声确定提示音。
- 显示屏将显示静音模式开。
- 红色 LED 灯开始闪烁，直至退出静音模式。
- 显示屏主屏幕上显示**静音模式**图标。
- 对讲机处于静音状态。
- 静音模式计时器开始倒数配置的持续时间。

设置静音模式计时器

可通过设置静音模式计时器在预配置的时间内启用静音模式功能。该计时器持续时间在对讲机菜单中配置，可设范围介于 0.5 至 6 小时。计时器到时后将退出静音模式。

如果计时器停留在 0 处，则对讲机将在无限期的时间段内保持静音模式，直至按预设的**静音模式**按钮。

- 按  访问菜单。

- 2 按  或  显示设置。按  进行选择。

- 3 按  或  显示对讲机设置。按  进行选择。

- 4 按  或  显示静音计时器。按  进行选择。

- 5 按  或  编辑每个数位的数值，然后按下 。

- 闪烁的红色 LED 指示灯关闭。
- **静音模式**图标将从主屏幕上消失。
- 您的对讲机将取消静音并恢复扬声器状态。
- 如果计时器未到时，则静音模式计时器将被暂停。



说明：

如果用户传输语音或切换至未预设的信道，则将退出静音模式。

紧急操作

紧急警报用于表示紧急状况。您可以在任何时候，甚至在当前信道上活动的情况下，发起紧急呼叫。

在 **Capacity Max** 中，接收对讲机一次仅可支持一个紧急警报。如果已发起，第二个紧急警报将覆盖第一个警报。

当接收到紧急警报时，接收者可通过按 **PTT** 按钮并发送非紧急语音信号来选择删除警报和退出报警列表，或对紧急警报作出响应。

您的经销商或系统管理员可以设置预设**紧急呼叫**按钮的按下持续时间（除了长按，长按的持续时间与所有其他按钮类似）：

短按

持续时间介于 0.05 秒至 0.75 秒之间。

退出静音模式

静音计时器到时后，此功能会自动退出。

执行以下任一操作手动退出静音模式：

- 按预设的**静音模式**按钮。
- 按任何条目上的 **PTT** 按钮。

禁用静音模式时，将发生以下情况：

- 发出一声否定提示音。
- 显示屏将显示静音模式关。

长按

持续时间介于 1.00 秒到 3.75 秒之间。

紧急呼叫按钮设有紧急呼叫开/关功能。有关**紧急呼叫**按钮所设置的操作功能，请联系您的经销商。



说明：

如果短按**紧急呼叫**按钮被设置为开启紧急模式，那么长按**紧急呼叫**按钮则设置为退出紧急模式。

如果长按**紧急呼叫**按钮被设置为开启紧急模式，那么短按**紧急呼叫**按钮则设置为退出紧急模式。

您的对讲机支持三种紧急报警：

- 紧急警报
- 带呼叫的紧急警报
- 带语音跟随的紧急警报

此外，每种警报有以下类型：

常规

对讲机发送警报信号并显示语音和/或视觉提示。

静音

对讲机发送警报信号，无任何语音或视觉提示。对讲机接收不通过扬声器发出提示音的呼叫，直到预设的**紧急麦克风**传输周期结束，并且/或者按 **PTT** 按钮。

带语音的静音

对讲机发送没有任何语音或视觉指示的警报信号，但允许呼入电话通过扬声器发出声音。



说明：

仅可将上述紧急警报中的一种分配给预设的**紧急呼叫**按钮或**紧急呼叫**脚踏开关。

发送紧急警报

该功能允许您发送非语音的紧急警报信号，它可以启动一组对讲机上的警报指示。按照步骤在对讲机上发送紧急警报。

当设置为“静音”时，您的对讲机在紧急呼叫模式下不会显示任何语音或视觉提示。

1 按预设的**紧急呼叫**开按钮。

您看到其中一个结果：

- 显示屏显示发射警报和目标别名。
- 显示屏显示发射电报和目标别名。

LED 绿灯亮起。 **紧急呼叫**图标出现。

**说明:**

如果已预设，紧急搜索提示音将响起。对讲机发射或接收语音时，此提示音为静音，对讲机退出紧急呼叫模式，此提示音将停止。可通过经销商或系统管理员预设紧急搜索提示音。

2 等待确认。

如果成功：

- 紧急呼叫提示音将响起。
- LED 绿灯闪烁。
- 显示屏显示已发警报。

如果在已达到最大重试次数后仍不成功：

- 将发出一声提示音。
- 显示屏显示警报失败。

对讲机退出紧急警报模式并返回主屏幕。

**说明:**

当配置为“仅紧急警报”时，紧急呼叫过程只包括紧急警报送达。当从系统接收到确认时或信道接入的尝试次数已用尽时，紧急呼叫结束。

作为“仅紧急警报”运行时，没有语音呼叫和紧急警报发送关联。

发送带呼叫的紧急警报

该功能允许您向一组对讲机或调度员发送带呼叫的紧急警报。经该组中的基础设施确认后，这一组对讲机可以通过预设的紧急信道进行通信。

对讲机必须配置“紧急警报”和“呼叫”，以在警报过程后执行紧急呼叫。

1 按预设的紧急呼叫开按钮。

显示屏显示发射警报和目标别名。**紧急呼叫**图标出现。LED 绿灯亮起。

**说明:**

如果已预设，紧急搜索提示音将响起。对讲机发射或接收语音时，此提示音为静音，对讲机退出紧急呼叫模式，此提示音将停止。

如果成功接收到紧急警报确认：

- 紧急呼叫提示音将响起。
- LED 绿灯闪烁。
- 显示屏显示已发警报。
- 显示屏显示紧急呼叫及目标通话组别名时，对讲机将进入紧急呼叫模式。

如果未成功接收到紧急警报确认：

- 所有重试次数用完后。
- 一声低音调提示音响起。
- 显示屏显示警报失败。
- 对讲机退出紧急警报模式。

2 按 PTT 按钮以发起语音传输。
LED 绿灯亮起。显示屏显示**组呼**图标。

3 执行以下操作之一：

- 等通话许可提示音结束后（启用该功能时）对着麦克风清楚地讲话。
- 等 **PTT** 侧音结束后（启用该功能时）对着麦克风清楚地讲话。

4 释放 PTT 按钮接听。
显示屏显示呼叫方和通话组别名。

5 如果启用“信道空闲提示”功能，则当发射对讲机释放 PTT 时，您将会听到一声短的提示音，表示此信道空闲，您可以应答。按 PTT 来回复该呼叫。

6 按紧急呼叫关按钮退出紧急呼叫模式。
对讲机将返回主屏幕。



说明：

您可能听到或听不到通话许可音，具体取决于对讲机的预设情况。对讲机的经销商或系统管理员可以提供关于对讲机针对紧急情况如何预设的更多信息。

紧急呼叫发起者可按 ，以结束进行中的紧急呼叫。对讲机将返回到呼叫空闲状态，但是紧急呼叫屏幕保持打开。

发送带语音跟随的紧急警报

该功能允许您向一组对讲机发送带语音跟随的紧急警报。对讲机的麦克风会自动激活，您无需按 **PTT** 按钮即可与该组

对讲机进行通信。这种激活的麦克风状态又称为**紧急麦克风**。

**说明：**

您的对讲机无法检测到后置附件连接器连接的非**IMPRES** 麦克风。

在指定的已预设连接器处未检测到麦克风时，对讲机将检查备用连接器。这时，对讲机将优先使用检测到的麦克风。

如果对讲机已启用紧急循环模式，则会在预设的持续时间内重复**紧急麦克风**和接收时间段。在紧急循环模式期间，通过扬声器收到呼叫音。

如果在预设的接收时间段内按**PTT** 按钮，您将听到一声禁止提示音，指示您应释放**PTT** 按钮。对讲机将忽略**PTT** 按钮按下操作并保持紧急呼叫模式。

如果您在**紧急麦克风**期间按**PTT** 按钮，并在**紧急麦克风**持续时间结束后继续按该按钮，则对讲机继续发射直至您释放**PTT** 按钮。

如果紧急警报请求发送失败，对讲机不会再尝试发送请求，而会直接进入**紧急麦克风**状态。

**说明：**

一些附件可能不支持**紧急麦克风**。请联系您的经销商或系统管理员了解详情。

按照步骤在对讲机上发送带语音跟随的紧急警报。

1 按预设的**紧急呼叫开按钮**或**紧急呼叫脚踏开关**。

您看到这些结果中的一个：

- 显示屏显示发射警报和目标别名。
- 显示屏显示发射电报和目标别名。

LED 绿灯亮起。 **紧急呼叫**图标出现。

2 显示屏显示已发警报后，对着麦克风清晰地讲话。

对讲机将在以下情况下自动停止发射：

- 在启用了紧急循环模式时，**紧急麦克风**和接收呼叫之间的循环持续时间结束。
 - 在禁用紧急循环模式时，**紧急麦克风**的持续时间结束。
-

3 按下**紧急呼叫关按钮**退出紧急呼叫模式。

对讲机将返回主屏幕。

接收紧急警报

接收对讲机一次仅可支持一个紧急警报。如果已发起，第二个紧急警报将覆盖第一个警报。按照步骤在对讲机上接收和查看紧急警报。

当您收到紧急警报时：

- 将发出一声提示音。
- 红色 LED 闪烁。
- 显示屏显示“紧急警报”列表、紧急通话组 ID 或别名、发射对讲机的 ID 或别名。

1 按  即可查看警报。

2 按  即可查看操作选项和警报列表中条目的详细信息。

3 按  并选择是以退出警报列表。

对讲机返回主屏幕，且顶部出现**紧急图标**，表示未解决的紧急警报。警报列表中的条目删除后，**紧急呼叫图标**消失。

4 按  访问菜单。



5 选择警报列表以重新访问警报列表。

6 将发出提示音，并且红色 LED 闪烁，直至退出紧急模式。但是，可将提示音关闭。执行以下操作之一：

- 按 **PTT** 按钮以呼叫收到紧急警报的对讲机组。
- 按下任何预设按钮。

对紧急警报做出响应

当接收到紧急警报时，接收者可通过按 **PTT** 按钮并发送非紧急语音信号来选择删除警报和退出报警列表，或对紧急警报作出响应。按照步骤在对讲机上对紧急警报做出响应。

1 如果启用紧急警报提示，当对讲机接收到紧急警报时，将出现紧急警报列表。按  或  显示所需的别名或 ID。

2 如果启用“信道空闲提示”功能，则当发射对讲机释放 **PTT** 时，您将会听到一声短的提示音，表示此信道空

闲，您可以应答。按**通话按键**可以向作为紧急警报目标的同一个通话组发送非紧急语音信号。

LED 绿灯亮起。

3 执行以下操作之一：

- 等通话许可提示音结束后（启用该功能时）对着麦克风清楚地讲话。
- 等 **PTT** 侧音结束后（启用该功能时）对着麦克风清楚地讲话。

4 释放 **PTT** 按钮接听。

发起紧急呼叫的对讲机作出响应时：

- LED 红灯闪烁。
- 显示屏显示**紧急呼叫**图标、紧急通话组 ID 或别名、发射对讲机的 ID 或别名。



说明：

如果未启用紧急呼叫提示，显示屏显示**组呼**图标、紧急通话组 ID 或别名、发射对讲机的 ID 或别名。

对带呼叫的紧急警报做出响应

按照步骤在对讲机上对带呼叫的紧急警报做出响应。

当您接收到紧急呼叫时：

- 如果启用了“紧急呼叫提示”和“紧急呼叫解码提示音”，将会发出紧急呼叫提示音。如果仅启用“紧急呼叫提示”，则不会发出紧急呼叫提示音。
- 显示屏右上角显示**紧急呼叫**图标。
- 文本行显示紧急通话组 ID 或别名、发射对讲机的 ID 或别名。
- 对讲机取消静音，呼入电话会通过扬声器发出声音。

- 1 如果启用“信道空闲提示”功能，则当发射对讲机释放 **PTT** 时，您将会听到一声短的提示音，表示此信道空闲，您可以应答。按 **PTT** 来回复该呼叫。

LED 绿灯亮起。

- 2 等通话许可提示音结束后（启用该功能时）对着麦克风清楚地讲话。

3 释放 **PTT** 按钮接听。

发起紧急呼叫的对讲机作出响应时：

- LED 红灯闪烁。

- 显示屏显示**紧急呼叫**图标、紧急通话组 ID 或别名、发射对讲机的 ID 或别名。



说明:

如果未启用紧急呼叫提示，显示屏显示**组呼**图标、紧急通话组 ID 或别名、发射对讲机的 ID 或别名。

Status Message

此功能允许用户向其他对讲机发送状态信息。

快速状态列表可使用 CPS-RM 配置，最多可包含 99 个状态。

每个状态信息的最大字符长度为 16。



说明:

每个状态都有一个介于 0-99 的对应数值。可为每个状态指定一个别名，以便于参考。



发送状态信息



按照以下步骤发送状态信息。



- 1 执行以下操作之一：
 - 按预设的**单键接入**按钮。跳过以下步骤。

- 按  访问菜单。

- 2 按  或  显示状态。按  进行选择。

- 3 按  或  显示快速状态。按  进行选择。

- 4 按  或  显示所需的**状态**信息。按  进行选择。

- 5 按  或  显示所需的**用户别名或 ID**，或**组别名或 ID**。按  进行选择。

如果成功：

- 发出一声确定提示音。
- LED 熄灭。
- 在返回快速状态屏幕之前，显示屏短暂显示确定性的**小型通知**。
- 显示屏在已发送的状态信息旁边显示 。

如果失败：



- 发出一声否定提示音。



- LED 熄灭。
- 在返回快速状态屏幕之前，显示屏短暂显示失败通知。

通过使用预设按钮发送状态信息

按照步骤通过使用预设按钮发送状态信息。

1 按预设的**状态信息**按钮。

2 按  或  显示所需的**状态信息**。按  进行选择。将显示通讯录。

3 按  或  显示所需的**用户别名或 ID**，或**组别名或 ID**。按  进行选择。

如果成功：

- 发出一声确定提示音。
- LED 指示灯关闭。
- 在返回快速状态屏幕之前，显示屏短暂显示确定性的**小型通知**。
- 显示屏在已发送的状态信息旁边显示 。



如果失败：



- 发出一声否定提示音。
- LED 指示灯关闭。
- 在返回快速状态屏幕之前，显示屏短暂显示失败通知。



使用通讯录列表发送状态信息



按照步骤使用通讯录列表发送状态信息。

1 按  访问菜单。

2 按  或  显示**通讯录**。按  进行选择。

3 按  或  显示所需的**用户别名或 ID**，或**组别名或 ID**。按  进行选择。

4 按  或  显示**发送状态**。按  进行选择。

5 按  或  显示所需的**状态信息**。按  进行选择。

如果成功：







- 发出一声确定提示音。
- LED 指示灯关闭。
- 在返回快速状态屏幕之前，显示屏短暂显示确定性的小型通知。
- 显示屏在已发送的状态信息旁边显示 ✓。



如果失败：

- 发出一声否定提示音。
- LED 指示灯关闭。
- 在返回快速状态屏幕之前，显示屏短暂显示失败通知。



通过使用手动拨号发送状态信息



按照步骤使用手动拨号发送状态信息。

- 1 按  访问菜单。
- 2 按  或  显示通讯录。按  进行选择。
- 3 按  或  显示手动拨号。按  进行选择。

- 4 按  或  显示号码。按  进行选择。

- 5 输入所需的用户别名或 ID，或组别名或 ID，然后按  继续。

- 6 按  或  显示发送状态。按  进行选择。

- 7 按  或  显示所需的狀態信息。按  进行选择。

如果成功：

- 发出一声确定提示音。
- LED 指示灯关闭。
- 在返回快速状态屏幕之前，显示屏短暂显示确定性的小型通知。
- 显示屏在已发送的状态信息旁边显示 ✓。

如果失败：

- 发出一声否定提示音。
- LED 指示灯关闭。
- 在返回快速状态屏幕之前，显示屏短暂显示失败通知。



查看状态信息

按照步骤查看状态信息。

1 按  访问菜单。

2 按  或  显示状态。按  进行选择。

3 按  或  显示收件箱。按  进行选择。

4 按  或  显示所需的狀態信息。按  进行选择。

将向对讲机用户显示状态信息的内容。

也可通过访问通知列表查看接收的状态信息。有关详细信息，请参阅[通知列表 \(第 149 页\)](#)。



回复状态信息

按照步骤回复状态信息。

1 按  访问菜单。



2 按  或  显示状态。按  进行选择。

3 按  或  显示收件箱。按  进行选择。

4 按  或  显示所需的狀態信息。按  进行选择。

5 将显示状态的内容。按  进行选择。

6 按  或  显示回复。按  进行选择。

7 按  或  显示所需的狀態信息。按  进行选择。

如果成功：

- 发出一声确定提示音。
- LED 指示灯关闭。
- 在返回收件箱屏幕之前，显示屏显示确定性的小型通知。
- 显示屏在已发送的状态信息旁边显示 。



如果失败：

- 发出一声否定提示音。
- LED 指示灯关闭。
- 在返回收件箱屏幕之前，显示屏短暂显示失败通知。

删除状态信息

按照步骤删除对讲机上的状态信息。

- 1 按  访问菜单。
- 2 按  或  显示状态。按  进行选择。
- 3 按  或  显示收件箱。按  进行选择。
- 4 按  或  显示所需的狀態信息。按  进行选择。
- 5 将显示状态的内容。按  进行选择。
- 6 按  或  显示删除。按  进行选择。

- 7 按  或  显示是。按  进行选择。

- 在返回收件箱屏幕之前，显示屏显示确定性的小型通知。

删除所有状态信息

按照步骤删除对讲机中的所有状态信息。

- 1 按  访问菜单。
- 2 按  或  显示状态。按  进行选择。
- 3 按  或  显示收件箱。按  进行选择。
- 4 按  或  显示全部删除。按  进行选择。
- 5 按  或  显示是。按  进行选择。

- 显示屏显示列表为空。

短信发送

您的对讲机可以接收数据，例如来自另一对讲机或短信应用程序的短信。

提供两种类型的短信，即数字车载台对讲机 (DMR) 短信和普通短信。一条 DMR 短信的最大长度为 23 个字符。一条普通短信的最大长度为 280 个字符，包括主题行。仅当从电子邮件应用程序收到消息时，主题行才会出现。



说明:

最大字符长度仅适用于具有最新软件和硬件的型号。对于具有较旧软件和硬件的对讲机型号，一条普通短信的最大长度为 140 个字符。请联系您的经销商或系统管理员了解详情。

短信

短信存储在收件箱中，并按照从新到旧的接收顺序排序。



不活动计时器超时后，对讲机退出当前屏幕。在任何时候长按  都可以返回主屏幕。

查看短信

按照步骤在对讲机上查看短信。



1 按  访问菜单。

2 按  或  显示信息。按  进行选择。

3 按  或  显示收件箱。按  进行选择。

如果收件箱为空：

- 显示屏显示列表为空。
 - 如果键盘音开启，对讲机会发出一声提示音。
-

4 按  或  显示所需的短信。按  进行选择。



如果短信来自电子邮件应用程序，显示屏会显示主题行。



查看遥感遥测状态短信

按照步骤查看收件箱中的遥感遥测状态短信。

1 按  访问菜单。

2 按  或  显示信息。按  进行选择。

3 按  或  显示收件箱。按  进行选择。

4 按  或  显示所需的短信。按  进行选择。

您不能回复遥感遥测状态短信。

显示屏显示遥感遥测：<状态短信>。

5 长按  返回主屏幕。

回复短信

按照步骤在对讲机上回复短信。

当您收到短信时：









- 显示屏显示含有发送者别名或 ID 的通知列表。
- 显示屏显示消息图标。





说明：

如果按 **PTT** 按钮，则对讲机将退出短信提示屏幕，并对短信发送者设置单呼或组呼。

1 执行以下操作之一：

- 按  或  显示阅读。按  进行选择。
显示屏显示短信。如果短信来自电子邮件应用程序，显示屏会显示主题行。
 - 按  或  显示稍后阅读。按  进行选择。
对讲机返回到接收短信前您所在的屏幕。
 - 按  或  显示删除。按  进行选择。
-

2 执行以下操作之一：

- 按  返回收件箱。
 - 再按一次  回复、转发或删除短信。
-

用预制短信回复短信



按照步骤在对讲机上用预制短信回复短信。

1 执行以下操作之一：

- 按预设的**短信**按钮。继续执行第 3 步。
- 按  访问菜单。



2 按  或  显示信息。按  进行选择。



3 按  或  显示收件箱。按  进行选择。



4 按  或  显示所需的短信。按  进行选择。

如果短信来自电子邮件应用程序，显示屏会显示主题行。

5 按  访问子菜单。

6 按  或  显示回复。按  进行选择。

7 按  或  显示快速回复。按  进行选择。

8 按  或  显示所需的短信。按  进行选择。

显示屏显示过渡性的小型通知，确认正在发送短信。

9 等待确认。

如果成功：

- 将发出一声提示音。
- 显示屏显示确定性的小型通知。

如果失败：

- 将发出一声提示音。
- 显示屏显示否定性的小型通知。
- 对讲机返回重发选项屏幕。

重发短信

按照步骤在对讲机上重发短信。

处于重发选项屏幕时：

按  将同一短信重发给同一用户或组别名或 ID。

如果成功：

- 发出一声确定提示音。
- 显示屏显示确定性的小型通知。



如果失败：



- 发出一声否定提示音。
- 显示屏显示否定性的小型通知。
- 对讲机返回重发选项屏幕。

转发短信

按照步骤在对讲机上转发短信。

处于重发选项屏幕时：

1 按  或  显示转发，然后按  将同一短信发送到另一个用户或通话组别名或 ID。

2 按  或  显示所需的别名或 ID。按  进行选择。

显示屏显示过渡性的小型通知，确认正在发送短信。

3 等待确认。

如果成功：

- 将发出一声提示音。
- 显示屏显示确定性的小型通知。

如果失败：

- 将发出一声提示音。
- 显示屏显示否定性的小型通知。







说明：



您也可以手动选择目标对讲机地址（请参阅[使用手动拨号转发短信 \(第 349 页\)](#)）。

使用手动拨号转发短信

按照步骤使用手动拨号在对讲机上转发短信。

- 1 按  或  显示转发。按  进行选择。

- 2 按  将同一短信发送给另一用户或通话组别名或 ID。

- 3 按  或  显示手动拨号。按  进行选择。
显示屏显示对讲机号：。

- 4 输入用户 ID，然后按  继续。
显示屏显示过渡性的小型通知，确认正在发送短信。

- 5 等待确认。
如果成功：
 - 将发出一声提示音。
 - 显示屏显示确定性的小型通知。
 如果失败：

- 将发出一声提示音。
- 显示屏显示否定性的小型通知。

编辑短信

选择编辑以编辑短信。



说明：









如果有主题行（对从电子邮件程序接收到的短信），您不能对该主题行进行编辑。

- 1 按  或  显示编辑。按  进行选择。
显示屏显示一个闪烁的光标。

- 2 用键盘编辑您的短信。
 - 按  向左移动一个空格。
 - 按  或  向右移动一个空格。
 - 按  删除任何无用的字符。
 - 长按  更改文本输入方法。

3 写完信息后按 。

4 执行以下操作之一：

- 按  或  至发送，然后按  以发送短信。
 - 按  或  至保存，然后按  以将短信保存至草稿箱文件夹。
 - 按  以编辑短信。
 - 按  以选择删除短信或将其保存至草稿箱文件夹。
-



编写短信

按照步骤在对讲机上编写短信。

1 执行以下操作之一：

- 按预设的**短信**按钮。继续 [步骤 3](#)。
 - 按  访问菜单。
-

2 按  或  显示信息。按  进行选择。

3 按  或  显示编辑。按  进行选择。此时将出现闪烁光标。

4 用键盘输入信息。

按  向左移动一个空格。

按  或  向右移动一个空格。





按  删除任何无用的字符。

长按  更改文本输入方法。

5 写完信息后按 。

执行以下操作之一：

• 按  发送信息。







• 按 。按  或  选择编辑、删除或保存信息。按  进行选择。

发送短信

按照步骤在对讲机上发送短信。

它假定您有新编写的短信或保存的短信。

选择收件人。执行以下操作之一：

- 按  或  显示所需的别名或 ID。按  进行选择。
- 按  或  显示手动拨号。按  进行选择。键入用户 ID。屏幕第一行显示对讲机号码：。屏幕第二行显示闪烁的光标。键入用户别名或 ID。按 。

屏幕显示过渡性的小型通知，确认正在发送短信。

如果成功：

- 将发出一声提示音。
- 屏幕显示确定性的小型通知。

如果失败：

- 一声低音调提示音响起。
- 屏幕显示否定性的小型通知。
- 短信被移至“已发信息”文件夹中。

- 短信标记为“发送失败”图标。



说明：

对于新编写的短信，对讲机将返回重发选项屏幕。

删除收件箱中的短信

按照步骤删除对讲机收件箱中的短信。



1 执行以下操作之一：

- 按预设的**短信**按钮。继续 [步骤 3](#)。
- 按  访问菜单。

2



按  或  显示信息。按  进行选择。

3

按  或  显示收件箱。按  进行选择。



如果收件箱为空：



- 显示屏显示列表为空。
- 将发出一声提示音。

- 4 按  或  显示所需的短信。按  进行选择。



如果短信来自电子邮件应用程序，显示屏会显示主题行。

- 5 按  访问子菜单。
-

- 6 按  或  显示删除。按  进行选择。
-

- 7 按  或  显示是。按  进行选择。



显示屏显示确定性的小型通知。屏幕返回到收件箱。



- 2 按  或  显示信息。按  进行选择。
-

- 3 按  或  显示收件箱。按  进行选择。

如果收件箱为空：

- 显示屏显示列表为空。
 - 将发出一声提示音。
-

- 4 按  或  显示全部删除。按  进行选择。
-

- 5 按  或  显示是。按  进行选择。

显示屏显示确定性的小型通知。

删除收件箱中的所有短信

按照步骤删除对讲机收件箱中的全部短信。

- 1 执行以下操作之一：
- 按预设的**短信**按钮。继续 [步骤 3](#)。
 - 按  访问菜单。
-

发送短信

将短信发送给另一对讲机后，它就会保存到已发信息文件夹中。始终将最近发送的短信添加到已发信息文件夹的顶部。您可以重发、转发、编辑或删除已发送的短信。

已发信息文件夹最多可存储 **30** 条最近发送的短信。当此文件夹已满后，下一条已发送的短信会自动替换此文件夹中最早的短信。

如果您在发送短信时退出短信发送屏幕，则对讲机将在“已发信息”文件夹中对短信状态进行更新，而不显示提示或通过声音提示。

如果已发信息文件夹里的短信状态在更新之前，对讲机模式发生改变或断电，则对讲机将无法完成正在进行的短信处理，并自动将其标记为**发送失败**图标。

对讲机最多可以同时处理五条短信。在此阶段，对讲机不能发送新的短信，并自动将其标记为**发送失败**图标。

在任何时候长按 ，对讲机都将返回主屏幕。



说明：

如果信道类型（如传统数字或智能信道共享信道）不匹配，则只能编辑、转发或删除已发送的短信。

查看已发送短信

按照步骤在对讲机上查看已发送短信。

1 执行以下操作之一：

- 按预设的**短信**按钮。继续 [步骤 3](#)。
- 按  访问菜单。

2 按 或 显示信息。按 进行选择。

3 按 或 显示已发信息。按 进行选择。

如果已发信息文件夹为空：

- 显示屏显示列表为空。
- 如果键盘音开启，对讲机会发出一声较低的提示音。

4 按 或 显示所需的短信。按 进行选择。

屏幕右上角的图标表示短信的状态。请参阅 [已发信息图标](#)。

发送已发送短信

按照步骤在对讲机上发送已发送短信。

查看已发送短信时：

1 按 。

2 您可以重发或转发已发送短信。执行以下操作之一：

-  显示重发。按  进行选择。

-  显示转发。按  进行选择。

显示屏显示过渡性的小型通知，确认正在发送短信。

3 等待确认。

如果成功：

- 将发出一声提示音。
- 显示屏显示确定性的小型通知。

如果失败：



- 将发出一声提示音。
- 显示屏显示否定性的小型通知。
- 对讲机将转入重发选项屏幕。有关详细信息，请参阅 [重发短信 \(第 120 页\)](#)。

删除已发信息文件夹中的已发送短信

按照步骤删除对讲机已发信息文件夹中的已发送短信。

查看已发送短信时：

- 1 按  。



- 2 按  或  显示删除。按  进行选择。



删除已发信息文件夹中的全部已发送短信

按照步骤删除对讲机已发信息文件夹中的全部已发送短信。

- 1 执行以下操作之一：



- 按预设的 **短信** 按钮。继续 [步骤 3](#)。
- 按  访问菜单。

- 2 按  或  显示信息。按  进行选择。







- 3 按  或  显示已发信息。按  进行选择。

如果已发信息文件夹为空：

- 显示屏显示列表为空。
- 将发出一声提示音。

- 4 按  或  显示全部删除。按  进行选择。

5 执行以下操作之一：

- 按  或  显示是。按  进行选择。显示屏显示确定性的小型通知。
- 按  或  显示否。按  进行选择。对讲机返回到前一屏幕。

- 按预设的**短信**按钮。继续 [步骤 3](#)。
- 按  访问菜单。

保存的短信

您可以保存短信以便稍后发送。

如果您在编写或编辑短信时按了**通话按钮**或模式更改导致对讲机退出短信编写/编辑屏幕，则当前的短信将被自动保存到“草稿箱”文件夹中。









最后保存的短信始终被加到“草稿箱”列表的顶部。

“草稿箱”文件夹最多可存储 **10** 条最近保存的短信。当此文件夹已满后，下一条保存的短信会自动替换此文件夹中最早的短信。

查看已保存的短信

按照步骤在对讲机上查看已保存的短信。

1 执行以下操作之一：

- 按  或  显示消息。按  进行选择。
- 按  或  显示草稿。按  进行选择。
- 按  或  显示所需的短信。按  进行选择。

编辑已保存的短信

按照步骤在对讲机上编辑保存的短信。

- 当查看短信时，按 。
- 按  或  显示编辑。按  进行选择。此时将出现闪烁光标。
- 用键盘输入信息。
按  向左移动一个空格。

按  或  向右移动一个空格。

按  删除任何无用的字符。

长按  更改文本输入方法。

4 写完信息后按 。

执行以下操作之一：

- 按  或  显示发送。按  发送信息。
- 按 。按  或  以选择保存信息或删除信息。按  进行选择。



删除“草稿箱”文件夹中保存的短信



按照步骤删除对讲机上草稿箱中保存的短信。



1 执行以下操作之一：

- 按预设的**短信**按钮。继续 [步骤 3](#)。
- 按  访问菜单。

2 按  或  显示消息。按  进行选择。

3 按  或  显示草稿。按  进行选择。

4 按  或  显示所需的短信。按  进行选择。

5 按  或  显示删除。按  删除短信。

预制短信

您的对讲机最多可支持 **50** 条通过经销商预设的预制短信。当预定义了预制短信时，您可以在发送每个短信之前对其进行编辑。

发送预制短信

按照步骤在对讲机上向预定义别名发送预制短信。



1 执行以下操作之一：



- 按预设的**短信**按钮。继续 [步骤 3](#)。
- 按预设的**单键接入**按钮。继续 [步骤 6](#)。

显示屏显示过渡性的小型通知，确认正在发送短信。

- 按  访问菜单。

2 按  或  显示信息。按  进行选择。

3 按  或  显示预制短信。按  进行选择。

4 按  或  显示所需的预制短信。按  进行选择。

5 执行以下操作以选择收件人并发送短信。

显示屏显示过渡性的小型通知，确认正在发送短信。

6 等待确认。

如果成功：

- 发出一声确定提示音。
- 显示屏显示确定性的小型通知。

如果失败：

- 发出一声否定提示音。

- 显示屏显示否定性的小型通知。
- 对讲机将转入重发选项屏幕。有关详细信息，请参阅 [重发短信 \(第 120 页\)](#)。

文本输入配置

您的对讲机允许您配置不同文本。

您可在对讲机上输入文本来配置以下设置：



- 字词预测
- 字词纠正
- 句首大写
- 我的新词

您的对讲机支持以下文本输入方法：

- 数字
- 符号
- 预测或多次击键
- 语言（如果已预设）



说明:





在任何时候按  都可以返回上一个屏幕或长按  返回主屏幕。不活动计时器超时后，对讲机退出当前屏幕。

启用或禁用文字校正

在内置字典无法识别输入文本编辑器中的字词时提供替代字词选择。







- 1 按  访问菜单。
- 2 按  或  显示设置。按  进行选择。
- 3 按  或  显示对讲机设置。按  进行选择。
- 4 按  或  显示文本输入。按  进行选择。
- 5 按  或  显示文字校正。按  进行选择。



6 执行以下操作之一：



- 按  或  显示文字校正。按  进行选择。
- 按 启用文字校正。如果启用，已启用旁出现 。
- 按 禁用文字校正。如果禁用，已启用旁的  消失。

启用或禁用词语预测





词语预测：您的对讲机可记住您经常输入的常用词序列。在您将常用词序列的第一个字输入到文本编辑器后，对讲机随后会预测下一个您可能会使用的字。

- 1 按  访问菜单。
- 2 按  或  显示设置。按  进行选择。
- 3 按  或  显示对讲机设置。按  进行选择。

4 按  或  显示文本输入。按  进行选择。

5 按  或  显示词语预测。按  进行选择。



6 执行以下操作之一：



- 按  启用词语预测。如果启用，已启用旁出现 。
 - 按  禁用麦克风动态失真控制。如果禁用，已启用旁的  消失。
-



句首大写



此功能用来自动使每个新句子的第一个单词的首字母大写。

1 按  访问菜单。





2 按  或  显示设置。按  进行选择。

3 按  或  显示对讲机设置。按  进行选择。

4 按  或  显示文本输入。按  进行选择。

5 按  或  显示句首大写。按  进行选择。

6 执行以下操作之一：

- 按  启用句首大写。如果启用，已启用旁出现 。
 - 按  禁用句首大写。如果禁用，已启用旁的  消失。
-

查看自定义字词

您可以将自己的自定义字词添加到对讲机的内置字典中。您的对讲机将保留一个包含这些字词的列表。

- 1 按  访问菜单。

- 2 按  或  显示设置。按  进行选择。

- 3 按  或  显示对讲机设置。按  进行选择。

- 4 按  或  显示文本输入。按  进行选择。

- 5 按  或  显示我的新词。按  进行选择。

- 6 按  或  显示字词列表。按  进行选择。
屏幕显示自定义字词列表。

编辑自定义字词

您可编辑对讲机中保存的自定义字词。

- 1 按  访问菜单。



- 2 按  或  显示设置。按  进行选择。

- 3 按  或  显示对讲机设置。按  进行选择。

- 4 按  或  显示文本输入。按  进行选择。





- 5 按  或  显示我的新词。按  进行选择。

- 6 按  或  显示字词列表。按  进行选择。
屏幕显示自定义字词列表。

7 按  或  显示所需字词。按  进行选择。

8 按  或  显示编辑。按  进行选择。

9 使用键盘编辑自定义字词。

- 按  向左移动一个空格。
- 按  键向右移动一个空格。
- 按  键删除任何无用的字符。
- 长按  更改文本输入方法。

10 自定义字词完成后按 。



屏幕显示过渡性的小型通知，确认正在保存自定义字词。



- 如果自定义字词已保存，发出一声提示音，且屏幕显示确定性的小型通知。
- 如果自定义字词未保存，发出一声低调提示音，且屏幕显示否定性的小型通知。



添加自定义字词



您可以将自定义字词添加到内置对讲机字典中。



1 按  访问菜单。

2 按  或  显示设置。按  进行选择。

3 按  或  显示对讲机设置。按  进行选择。





4 按  或  显示文本输入。按  进行选择。

5 按  或  显示我的新词。按  进行选择。

6 按  或  显示添加新词。按  进行选择。

屏幕显示自定义字词列表。

7 使用键盘编辑自定义字词。

- 按  向左移动一个空格。
- 按  键向右移动一个空格。
- 按  键删除任何无用的字符。
- 长按  更改文本输入方法。

8 自定义字词完成后按 .



屏幕显示过渡性的小型通知，确认正在保存自定义字词。



- 如果自定义字词已保存，发出一声提示音，且屏幕显示确定性的小型通知。
- 如果自定义字词未保存，发出一声低调提示音，且屏幕显示否定性的小型通知。



删除自定义字词



按照步骤删除保存在对讲机中的自定义字词。



1 按  访问菜单。

2 按  或  显示设置。按  进行选择。

3 按  或  显示对讲机设置。按  进行选择。





4 按  或  显示文本输入。按  进行选择。

5 按  或  显示我的新词。按  进行选择。

6 按  或  显示所需字词。按  进行选择。

7 按  或  显示删除。按  进行选择。

8 选择以下选项之一。

- 出现删除条目？时，按  选择是。屏幕显示条目已删除。
- 按  或  显示否。按  返回前一屏幕。

删除全部自定义字词

按照步骤删除对讲机内置字典中的全部自定义字词。

- 1 按  访问菜单。

- 2 按  或  显示设置。按  进行选择。





- 3 按  或  显示对讲机设置。按  进行选择。

- 4 按  或  显示文本输入。按  进行选择。

- 5 按  或  显示我的新词。按  进行选择。

- 6 按  或  显示全部删除。按  进行选择。

- 7 执行以下操作之一：

- 出现删除条目？时，按  选择是。显示屏显示所有条目已删除。
- 按  或  显示否以返回前一屏幕。按  进行选择。

任务

此功能允许您的对讲机接收调度员发送的信息，列出了要执行的任务。



说明：

此功能可以根据用户要求通过 CPS 自定义。请联系您的经销商或系统管理员了解详情。

有两个文件夹包含不同的任务：

我的任务文件夹

分配给您的登录用户 ID 的个性化任务。

共享任务文件夹

分配给个人组的共享任务。

您可以回复任务，以便将任务分类到任务文件夹中。默认情况下，这些文件夹包括**全部**、**新增**、**已启动**和**已完成**。有关其他 10 个文件夹，请联系您的经销商或系统管理员。



说明：

甚至在关闭对讲机并重新打开之后，仍会保留这些任务。

所有任务均位于**全部**文件夹。根据您对讲机的预设方式，任务按其优先级再按接收时间排序。首先列出新任务、最近更改了状态的任务以及优先级最高的任务。达到最大任务数时，下一个任务会自动替换对讲机中的最后一个任务。您的对讲机最多支持 **100** 或 **500** 个任务，具体取决于您的对讲机型号。请联系您的经销商或系统管理员了解详情。您的对讲机自动检测和丢弃具有相同任务 ID 的重复任务单。

根据任务的重要性，调度员会为其添加优先级。有三个优先级：优先级 **1**、优先级 **2** 和优先级 **3**。优先级 **1** 是最高优先级，而优先级 **3** 是最低优先级。也有无优先级的任务。

调度员进行以下更改时，您的对讲机将相应更新：

- 修改任务的内容。
- 添加或编辑任务的优先级。
- 在文件夹之间移动任务。
- 取消任务。



访问“任务”文件夹



按照步骤访问“任务”文件夹。

1 执行以下操作之一：

- 按预设的**任务**按钮。继续 **步骤 3**。
- 按  访问菜单。

2 按  或  显示任务单。按  进行选择。



3 按  或  显示所需的文件夹。按  进行选择。

4 按  或  显示所需的任务单。按  进行选择。

登录远程服务器或从远程服务器注销

此功能允许以您的用户 ID 登录远程服务器和从远程服务器注销。

1 按  访问菜单。

2 按  或  以登录。按  进行选择。

如果已登录，菜单将显示注销。

显示屏显示过渡性的小型通知，指示正在处理该请求。

3 等待确认。

如果成功：

- 发出一声确定提示音。
- 显示屏显示确定性的小型通知。

如果失败：

- 发出一声否定提示音。
- 显示屏显示否定性的小型通知。



创建任务

您的对讲机可以基于任务模板创建任务，以及发送需要执行的任务。

需要 CPS 编程软件来配置任务单模板。

- 1 按  访问菜单。



- 2 按  或  显示任务。按  进行选择。



- 3 按  或  显示创建任务单。按  进行选择。



回复任务

按照步骤在对讲机上回复任务。

- 1 按  访问菜单。



- 2 按  或  显示任务。按  进行选择。

- 3 按  或  显示所需的文件夹。按  进行选择。

- 4 按  或  显示所需的任务。按  进行选择。

- 5 再次按  进入子菜单。

您也可以按相应的数字键 (1 - 9) 来快速回复。

- 6 按  或  显示所需的任务。按  进行选择。

显示屏显示过渡性的小型通知，指示正在处理该请求。

- 7 等待确认。

如果成功：

- 发出一声确定提示音。
- 显示屏显示确定性的小型通知。



如果失败：



- 发出一声否定提示音。
 - 显示屏显示否定性的小型通知。
-



使用一个任务模板发送任务

如果对讲机配置了一个任务模板，请执行以下操作以发送任务。

- 1 使用键盘输入所需的房号。按  进行选择。
-

- 2 按  或  显示房间状态。按  进行选择。
-

- 3 按  或  显示所需的选项。按  进行选择。
-

- 4 按  或  显示发送。按  进行选择。
显示屏显示过渡性的小型通知，指示正在处理该请求。
-

- 5 等待确认。

如果成功：



- 发出一声确定提示音。
- 显示屏显示确定性的小型通知。



如果失败：

- 发出一声否定提示音。
 - 显示屏显示否定性的小型通知。
-

使用多个任务模板发送任务

如果对讲机配置了多个任务模板，请执行以下操作以发送任务。

1 按  或  显示所需的选项。按  进行选择。

2 按  或  显示发送。按  进行选择。
显示屏显示过渡性的小型通知，指示正在处理该请求。

3 等待确认。

如果成功：

- 发出一声确定提示音。
- 显示屏显示确定性的小型通知。

如果失败：

- 发出一声否定提示音。
 - 显示屏显示否定性的小型通知。
-



删除任务



按照步骤删除对讲机上的任务。



1 执行以下操作之一：

- 按预设的**任务**按钮。继续 [步骤 4](#)
 - 按  访问菜单。
-



2 按  或  显示任务。按  进行选择。

3 按  或  显示所需的文件夹。按  进行选择。

4 按  或  显示全部文件夹。按  进行选择。

5 按  或  显示所需的任务。按  进行选择。

6 查看任务时，再按一次  。

- 7 按  或  显示删除。按  进行选择。
显示屏显示过渡性的小型通知，指示正在处理该请求。
-

8 等待确认。

如果成功：

- 发出一声确定提示音。
- 显示屏显示确定性的小型通知。

如果失败：

- 发出一声否定提示音。
 - 显示屏显示否定性的小型通知。
-



删除所有任务



按照步骤删除对讲机上的所有任务。



1 执行以下操作之一：

- 按预设的**任务**按钮。继续 [步骤 3](#)。
 - 按  访问菜单。
-







- 2 按  或  显示任务。按  进行选择。
-

- 3 按  或  显示所需的文件夹。按  进行选择。
-

- 4 按  或  显示全部文件夹。按  进行选择。
-

- 5 按  或  显示全部删除。按  进行选择。
-

6 执行以下操作之一：

- 按  或  显示是。按  进行选择。
显示屏显示确定性的小型通知。
 - 按  或  显示否。按  进行选择。
对讲机返回到前一屏幕。
-

加密

此功能有利于防止信道上未经授权的用户利用软件加密解决方案进行窃听。发射的信令和用户识别部分未加密。

对讲机必须启用信道的加密功能才能发送加密发射信号，虽然这不是接收发射的必需要求。在启用加密的信道上，对讲机仍能接收清晰或未加密的传输信号。

您的对讲机仅支持增强型加密。要对加密呼叫或数据发射信号进行解密，您的对讲机必须进行预设，以便与发射对讲机拥有相同的密钥值和密钥 ID（对于增强型加密）。

如果您的对讲机收到具有不同密钥值和密钥 ID 的加密呼叫，您将什么也听不到（对于增强型加密）。

您的对讲机可在加密信道上接收清晰或未加密的呼叫，具体取决于对讲机的设定方式。此外，根据设定方式，您的对讲机还可发出警告音。



说明：

此功能不适用于频率相同的民用频段信道。

当对讲机传输信号时，绿色 LED 指示灯亮起，而当对讲机接收传入的加密传输信号时，绿色 LED 指示灯则快速闪烁。



说明：

一些对讲机型号可能不提供此加密功能，或可能会有不同的配置。请联系您的经销商或系统管理员了解详情。



打开或关闭加密

按照步骤打开或关闭对讲机上的加密。



1 执行以下操作之一：

- 按预设的**加密**按钮。跳过以下步骤。
- 按  访问菜单。

2

按  或  显示设置。按  进行选择。

3

按  或  显示对讲机设置。按  进行选择。

4

按  或  显示加密。按  进行选择。

5 执行以下操作之一：

- 按  或  显示开。按  进行选择。显示屏在开旁边显示 。
- 按  或  显示关。按  进行选择。显示屏在关旁边显示 。

响应抑制

此功能有助于防止对讲机响应任何呼入传输。



说明：

这是一项可购买功能。咨询经销商或系统管理员以确定对讲机的预设情况。

如果启用此功能，则您的对讲机将不会生成任何呼出传输，以响应呼入传输，如对讲机检测、呼叫提示、对讲机遥毙、远程监听、自动注册服务 (ARS)、响应私人消息和发送 GNSS 定位报告。如果启用此功能，则您的对讲机无法接收已确认单呼。但是，您的对讲机可以手动发送传输。

打开或关闭响应抑制

按照步骤启用或禁用对讲机上的响应抑制。

按预设的**响应抑制**按钮。

如果成功：

- 发出一声确定提示音。
- 显示屏显示确定性的小型瞬间通知。

如果失败：

- 发出一声否定提示音。
- 显示屏显示否定性的小型瞬间通知。

临时关闭/恢复

此功能允许您启用或禁用系统中的任何对讲机。例如，经销商或系统管理员可能想要禁用被盗的对讲机以防止未经授权的用户使用，并在对讲机恢复后启用它。

对讲机可通过控制台或另一台对讲机发起的命令禁用（临时关闭）或启用（恢复）。

对讲机禁用后，将发出否定提示音并且主屏幕将显示信道被拒绝。

当对讲机临时关闭时，对讲机无法在执行临时关闭程序的系统上请求或接收任何用户发起的服务。但是，对讲机可切换为另一系统。在临时关闭时，对讲机可继续发送 GNSS 定位报告以及进行远程监听。





说明：

经销商或系统管理员可以永久禁用对讲机。有关详细信息，请参阅[对讲机终止 \(第 146 页\)](#)。

临时关闭对讲机

按照步骤禁用对讲机。

- 1 按预设的**对讲机遥毙**按钮。
-

2 按  或  显示所需的别名或 ID。按  进行选择。

显示屏显示过渡性的小型通知，指示正在处理该请求。LED 绿灯闪烁。

3 等待确认。

如果成功：

- 发出一声确定提示音。
- 显示屏显示确定性的小型通知。

如果失败：



- 发出一声否定提示音。
 - 显示屏显示否定性的小型通知。
-



使用通讯录列表临时关闭对讲机

按照步骤使用通讯录列表禁用对讲机。

1 按  访问菜单。

2 按  或  显示通讯录。按  进行选择。

3 按  或  显示所需的别名或 ID。按  进行选择。

4 按  或  显示对讲机遥毙。按  进行选择。

显示屏显示过渡性的小型通知，指示正在处理该请求。LED 绿灯闪烁。

5 等待确认。

如果成功：

- 发出一声确定提示音。
- 显示屏显示确定性的小型通知。

如果失败：

- 发出一声否定提示音。
 - 显示屏显示否定性的小型通知。
-

使用手动拨号临时关闭对讲机

按照步骤使用手动拨号禁用对讲机。

- 1 按  访问菜单。
- 2 按  或  显示通讯录。按  进行选择。
- 3 按  或  显示手动拨号。按  进行选择。
- 4 按  或  显示号码。按  进行选择。
第一行文字显示对讲机号：
- 5 输入用户 ID，然后按  继续。
- 6 按  或  显示对讲机遥毙。按  进行选择。
显示屏显示过渡性的小型通知，指示正在处理该请求。LED 绿灯闪烁。

- 7 等待确认。

如果成功：



- 发出一声确定提示音。
- 显示屏显示确定性的小型通知。

如果失败：

- 发出一声否定提示音。
- 显示屏显示否定性的小型通知。

恢复对讲机

按照步骤激活对讲机。

- 1 按预设的**对讲机激活**按钮。
- 2 按  或  显示所需的别名或 ID。按  进行选择。
屏幕显示对讲机激活及用户别名或 ID。LED 绿灯亮起。
- 3 等待确认。
如果成功：

- 发出一声确定提示音。
- 显示屏显示确定性的小型通知。

如果失败：

- 发出一声否定提示音。
- 显示屏显示否定性的小型通知。

屏幕显示对讲机激活及用户别名或 ID。LED 绿灯亮起。

使用通讯录列表恢复对讲机

按照步骤使用通讯录列表激活对讲机。

- 1 按  访问菜单。
- 2 按  或  显示通讯录。按  进行选择。
- 3 按  或  显示所需的别名或 ID。按  进行选择。
- 4 按  或  显示对讲机激活。按  进行选择。
LED 绿灯闪烁。

-
- 5 等待确认。

如果成功：





- 将发出一声提示音。
- 显示屏显示对讲机激活成功。



如果失败：



- 将发出一声提示音。
- 显示屏显示对讲机激活失败。

使用手动拨号恢复对讲机



按照步骤使用手动拨号激活对讲机。

- 1 按  访问菜单。
- 2 按  或  显示通讯录。按  进行选择。

3 按  或  显示手动拨号。按  进行选择。

4 按  或  显示单呼。按  进行选择。
第一行文字显示对讲机号码：

5 输入用户 ID，然后按  继续。

6 按  或  显示对讲机激活。按  进行选择。

LED 绿灯闪烁。
屏幕显示对讲机激活及用户别名或 ID。LED 绿灯亮起。

7 等待确认。

如果成功：

- 将发出一声提示音。
- 显示屏显示对讲机激活成功。

如果失败：

- 将发出一声提示音。

- 显示屏显示对讲机激活失败。

对讲机终止

此功能是限制对对讲机进行未经授权访问的增强型安全措施。

对讲机终止会导致对讲机无法正常工作。例如，经销商或系统管理员可能想要终止失窃或放置不当的对讲机运行，以防未经授权的使用。

打开后，被终止的对讲机将在屏幕上短暂显示对讲机已终止，以表示当前处于终止状态。



说明：

被终止的对讲机只能在 **Motorola Solutions** 维修点恢复。请联系您的经销商或系统管理员了解详情。

单独工作者

如果在预定义的时间内没有用户活动（例如按任何对讲机按钮或激活信道选择器），此功能将提示用户需要发出紧急警报。

在一段预设的持续时间内没有用户活动之后，一旦不活动时器到期，对讲机就使用语音提示向您发出预先警告。

如果在预定义的提醒计时器到期前您仍没有确认，对讲机将启动由经销商或系统管理员预设的紧急条件。

有关详细信息，请参阅[紧急操作 \(第 105 页\)](#)。



说明：

请联系您的经销商或系统管理员了解详情。

开机密码功能

此功能允许您通过在打开设备时询问密码来限制对讲机的访问。

您可以使用键盘麦克风或**向上/向下滚动**按钮来输入密码。

使用密码访问对讲机

按照步骤使用密码访问对讲机。



1 输入当前的四位数密码。



说明：

使用**紧急呼叫**脚踏开关取消密码输入，可以访问对讲机。

- 使用键盘麦克风。

- 按  或  编辑每个数位的数值，然后按  进入并移至下一数位。

2

按  输入密码。

如果成功，则对讲机将开机。

如果失败：

- 尝试第一次和第二次后，显示屏显示密码错误。重复**步骤 1**。
- 尝试第三次后，显示屏显示密码错误，然后显示对讲机已锁定。将发出一声提示音。黄色 LED 指示灯双闪。对讲机进入锁定状态持续 **15 分钟**。



说明：

在锁定状态下，对讲机仅对**开/关/音量控制旋钮**和预设的**背光**按钮的输入作出响应。

解除对讲机锁定状态

在锁定状态下，您的对讲机无法接收呼叫。按照步骤解锁处于锁定状态的对讲机。



执行以下操作之一：

- 如果对讲机已开机，请等待 15 分钟，然后重复 [使用密码访问对讲机 \(第 147 页\)](#) 中的步骤以访问对讲机。
- 如果对讲机已关机，请将对讲机开机。您的对讲机将重新启动计时器，锁定 15 分钟。将发出一声提示音。黄色 LED 指示灯双闪。显示屏将显示对讲机已锁定。
等待 15 分钟，然后重复 [使用密码访问对讲机 \(第 147 页\)](#) 中的步骤以访问对讲机。

打开或关闭开机密码

按照步骤打开或关闭对讲机上的密码锁。

- 1 按  访问菜单。
- 2 按  或  显示设置。按  进行选择。
- 3 按  或  显示对讲机设置。按  进行选择。
- 4 按  或  显示开机密码。按  进行选择。

- 5 输入当前的四位数密码。
 - 使用键盘麦克风。
 - 按  或  编辑每个数位的数值，然后按  进入并移至下一数位。
每输入一位密码时，您都会听到一声确定提示音。

- 6 按  输入密码。
如果密码不正确，显示屏会显示密码错误，并自动返回上一级菜单。

- 7 执行以下操作之一：
 - 按  或  显示打开。按  进行选择。
显示屏在打开旁显示 。
 - 按  或  显示关闭。按  进行选择。
显示屏在关闭旁显示 。

更改密码

按照步骤更改对讲机上的密码。

- 1 按  访问菜单。

- 2 按  或  显示设置。按  进行选择。

- 3 按  或  显示对讲机设置。按  进行选择。

- 4 按  或  显示开机密码。按  进行选择。

- 5 输入当前的四位数密码，然后按  继续。
如果密码不正确，显示屏会显示密码错误，并自动返回上一级菜单。

- 6 按  或  显示改变开机密码。按  进行选择。

- 7 输入一个新的四位数密码，然后按  继续。

- 8 重新输入新的四位数密码，然后按  继续。

如果成功，显示屏显示密码更改成功。

如果失败，显示屏显示密码不匹配。

屏幕自动返回上一级菜单。

通知列表

您的对讲机上有一个通知列表，该列表收集了信道上的所有未读事件，例如未读的短信、遥感遥测信息、未接呼叫和呼叫提示。

当通知列表中有一个或多个事件时，显示屏显示**通知**图标。



该列表支持最多 **40** 个未读事件。当列表已满时，下一个事件会自动替换最早的事件。当读取了某个事件后，该事件会从通知列表中移除。



对于短信、未接来电和呼叫提示事件，通知的最大数量为 **30** 条短信和 **10** 个未接呼叫或呼叫提示。此最大数量取决于各个功能（任务、短信或未接来电或呼叫提示）列表功能。

访问通知列表

按照步骤访问对讲机上的通知列表。

- 1 按  访问菜单。

- 2 按  或  显示通知。按  进行选择。

- 3 按  或  显示所需的事件。按  进行选择。

长按  返回主屏幕。

无线编程

您的经销商可使用不带物理连接的无线编程 (OTAP) 远程更新您的对讲机。此外，某些设置还可使用 OTAP 配置。

当对讲机进行 OTAP 时，绿色 LED 闪烁。

当对讲机接收大批量数据时：

- 显示屏显示**大批量数据**图标。
- 信道变得繁忙。
- 如果您按 **PTT** 按钮，将发出一声否定提示音。

当 OTAP 完成时，根据配置：

- 将发出一声提示音。显示屏显示更新重启。对讲机将通过关机并再次打开来重新启动。
- 您可以选择立即重启或推迟。选择推迟时，您的对讲机将返回到前一屏幕。显示屏显示 **OTAP 延迟计时器** 图标，直到发生自动重新启动。

当对讲机在自动重新启动后通电：

- 如果成功，显示屏显示软件更新完成。
- 如果失败，显示屏显示软件更新失败。

有关已更新软件版本的信息，请参阅[检查软件更新信息 \(第 176 页\)](#)。

选择第三方外围设备连接模式

按照步骤选择下面的第三方外围设备连接模式之一：

- **Motorola Solutions**
- PC 和音频
- 数据附件
- 遥感遥测

- 通用

- 1 按  访问菜单。

- 2 按  或  显示设置。按  进行选择。

- 3 按  或  显示对讲机设置。按  进行选择。

- 4 按  或  显示电缆类型。按  进行选择。

- 5 按  或  显示所需的连接模式。按  进行选择。
 屏幕显示选定的连接模式。屏幕将返回上一级菜单。



接收信号强度指示

此功能允许您查看接收信号强度指示 (RSSI) 值。

显示屏右上角显示 **RSSI** 图标。有关 **RSSI** 图标的更多信息，请参见[显示屏图标](#)。

查看 RSSI 值

将四向导航键盘麦克风 (Motorola Solutions 部件号 RMN5127_) 连接至对讲机。

在主屏幕中，使用四向导航键盘麦克风，按  三次并立即按  三次。

屏幕显示当前 **RSSI** 值。

要返回主屏幕，请按住 。

前面板配置



您可在前面板配置 (FPC) 中自定义某些功能参数，以增强您的对讲机的用途。



进入前面板配置模式

按照步骤在对讲机上进入前面板编程模式。

在任何时候长按  都可以返回主屏幕。





- 1 按  访问菜单。

2 按  或  显示设置。按  进行选择。

3 按  或  显示对讲机配置。按  进行选择。

编辑 FPP 模式参数

根据需要使用以下按钮，以便浏览各个功能参数。

-  ,  - 滚动浏览各个选项、增加/减小数值或垂直浏览。
-  - 选择选项或进入子菜单。
-  - 短按返回上一菜单或退出选择屏幕。长按返回主屏幕。

Wi-Fi 操作

此功能允许您设置和连接至 Wi-Fi 网络。Wi-Fi 支持更新对讲机固件、Codeplug 和资源，例如语言包和语音提示。



说明：

此功能仅适用于 XiR M8668i/CM7668i。

Wi-Fi® 是 Wi-Fi Alliance® 的注册商标。

对讲机支持 WEP/WPA/WPA2-个人和 WPA/WPA2-企业 Wi-Fi 网络。

WEP/WPA/WPA2-个人 Wi-Fi 网络

使用基于预共享密钥（密码）的身份验证。

预共享密钥可使用菜单或 CPS/对讲机管理输入。

WPA/WPA2-企业 Wi-Fi 网络

使用基于证书的身份验证。

对讲机必须预配置有证书。



说明：

要连接到 WPA/WPA2-企业 Wi-Fi 网络，请咨询经销商或系统管理员。

预设的**打开或关闭 Wi-Fi** 按钮由您的经销商或系统管理员分配。咨询经销商或系统管理员以确定对讲机的预设情况。

预设的**打开或关闭 Wi-Fi** 按钮的语音提示可以根据用户要求，通过 CPS 自定义。请联系您的经销商或系统管理员了解详情。



说明：

您可以使用监控对讲机远程打开或关闭 Wi-Fi（请参阅[使用监控对讲机打开或关闭 Wi-Fi](#)）。请联系您的经销商或系统管理员了解详情。

打开或关闭 Wi-Fi

按照步骤打开或关闭 Wi-Fi。

- 1 按预设的**打开或关闭 Wi-Fi** 按钮。语音提示会发出：
打开或关闭 Wi-Fi。

- 2 使用菜单访问此功能。
 - a 按  访问菜单。
 - b 按  或  显示 Wi-Fi，然后按  进行选择。
 - c 按  或  显示 Wi-Fi 开和按  进行选择。
 - d 按  以打开/关闭 Wi-Fi。

如果 Wi-Fi 处于打开状态，屏幕将在已启用旁边显示 。

如果 Wi-Fi 处于关闭状态， 将从已启用旁边消失。

使用指定的对讲机（单独控制）远程打开或关闭 Wi-Fi

进行单独控制（一对一）时，请按照下面的过程操作，远程打开或关闭 Wi-Fi。



说明：

具有特定 CPS 设置的对讲机才支持此功能，请联系您的经销商或系统管理员了解更多信息。

- 1 执行以下操作之一：
 - 长按可预设按钮。使用键盘输入 ID，并按  进行选择。继续 [步骤 3](#)。
 - 按  访问菜单。

- 2 按  或  显示通讯录和按  进行选择。

- 3 按  或  至 Wi-Fi 控制，然后按  进行选择。

- 4 按  或  以选择开或关。

- 5 按  进行选择。

如果成功，显示屏显示肯定的小型通知。

如果不成功，显示屏显示否定性的小型通知。



使用指定的对讲机（通话组控制）远程打开或关闭 Wi-Fi

进行通话组控制（一对多）时，请按照下面的过程操作，远程打开或关闭 Wi-Fi。



说明：

具有特定 CPS 设置的对讲机才支持此功能，请联系您的经销商或系统管理员了解更多信息。

- 1 按  访问菜单。
- 2 按  或  显示通讯录和按  进行选择。
- 3 按  或  选择所需的用户别名或 ID。
- 4 按  或  至 WiFi 控制，然后按  进行选择。

- 5 按  或  以选择开或关。

- 6 按  进行选择。

如果成功，显示屏显示发送成功。

如果不成功，显示屏显示否定性的小型通知。

连接到网络接入点







当您打开 Wi-Fi 时，对讲机扫描并连接到网络接入点。





说明：

您也可以使用菜单连接到网络接入点。

WPA-企业 Wi-Fi 网络接入点可预配置。咨询经销商或系统管理员以确定对讲机的预设情况。



- 1 按  访问菜单。
- 2 按  或  显示 WiFi，然后按  进行选择。
- 3 按  或  显示网络，然后按  进行选择。

- 4 按  或  显示一个网络接入点，然后按  进行选择。



说明:

对于 WPA-企业 Wi-Fi，如果未预配置网络接入点，则连接选项不可用。

- 5 按  或  显示连接，然后按  进行选择。

- 6 对于 WPA-个人 Wi-Fi，输入密码并按  。

- 7 对于 WPA-企业 Wi-Fi，密码可使用对讲机管理进行配置。

如果预配置的密码正确，则对讲机会自动连接到选定的网络接入点。

如果预配置的密码不正确，显示屏会显示身份验证失败，并自动返回到上一级菜单。

如果连接成功，对讲机会显示一条通知并将网络接入点保存到配置文件列表中。

如果连接失败，对讲机显示屏会短暂显示故障通知屏幕并自动返回到上一级菜单。

检查 Wi-Fi 连接状态

按照步骤检查 Wi-Fi 连接状态。

按预设的 **Wi-Fi 状态查询**按钮，使用语音提示了解连接状态。语音提示发出：**Wi-Fi 关闭**、**Wi-Fi 打开但未建立连接**，或 **Wi-Fi 打开并建立连接**。

- 关闭 Wi-Fi 时，显示屏显示 Wi-Fi 关。
- 对讲机连接至网络时，显示屏显示 Wi-Fi 开，已连接。
- Wi-Fi 打开但对讲机未连接至任何网络时，显示屏显示 Wi-Fi 开，连接断开。

Wi-Fi 状态查询结果的语音提示可以根据用户要求，通过 CPS 自定义。请联系您的经销商或系统管理员了解详情。









说明:

预设的 **Wi-Fi 状态查询**按钮由您的经销商或系统管理员分配。咨询经销商或系统管理员以确定对讲机的预设情况。

刷新网络列表



按照步骤刷新网络列表。

- 通过菜单执行以下操作以刷新网络列表。

- a. 按  访问菜单。
- b. 按  或  显示 WiFi，然后按  进行选择。
- c. 按  或  显示网络，然后按  进行选择。

当您进入“网络”菜单时，对讲机将自动刷新网络列表。

- 如果您已在“网络”菜单中，请执行以下操作以刷新网络列表。

按  或  至刷新，然后按  进行选择。

对讲机将刷新并显示最新的网络列表。

添加网络



说明:

此任务不适用于 WPA-企业 Wi-Fi 网络。

如果首选网络不在可用网络列表中，请执行以下操作以添加网络。

- 1 按  访问菜单。

 - 2 按  或  显示 WiFi，然后按  进行选择。

 - 3 按  或  显示网络，然后按  进行选择。

 - 4 按  或  至添加网络，然后按  进行选择。

 - 5 输入服务集标识符 (SSID)，然后按  。
 - 6 按  或  至打开，然后按  进行选择。

 - 7 输入密码并按  。
- 对讲机将显示确定性的小型通知，指明已成功保存网络。
-

查看网络接入点的详细信息

您可以查看网络接入点的详细信息。

- 1 按  访问菜单。

- 2 按  或  显示 WiFi，然后按  进行选择。

- 3 按  或  显示网络，然后按  进行选择。

- 4 按  或  显示一个网络接入点，然后按  进行选择。

- 5 按  或  至查看详情，然后按  进行选择。



说明：

WPA-个人 Wi-Fi 和 WPA-企业 Wi-Fi 显示网络接入点的不同详细信息。

WPA-个人 Wi-Fi

对于已连接的网络接入点，对讲机显示服务集标识符 (SSID)、安全模式、媒体访问控制 (MAC) 地址和互联网协议 (IP) 地址。

对于未连接的网络接入点，对讲机显示 SSID 和安全模式。

WPA-企业 Wi-Fi

对于已连接的网络接入点，对讲机显示 SSID、安全模式、身份、扩展身份验证协议 (EAP) 方法、阶段 2 身份验证、证书名称、MAC 地址、IP 地址、网关、DNS1 和 DNS2。

对于未连接的网络接入点，对讲机显示 SSID、安全模式、身份、EAP 方法、阶段 2 身份验证和证书名称。

删除网络接入点









说明：



此任务不适用于企业 Wi-Fi 网络。



请执行以下操作以从配置文件列表中删除网络接入点。

- 1 按  访问菜单。

2 按  或  显示 WiFi，然后按  进行选择。

3 按  或  显示网络，然后按  进行选择。

4 按  或  至所选网络接入点，然后按  进行选择。

5 按  或  至删除，然后按  进行选择。

6 按  或  至是，然后按  进行选择。

对讲机将显示确定性的小型通知，指明已成功删除所选的网络接入点。

动态通话组号码分配 (DGNA)

动态通话组号码分配 (DGNA) 这项功能允许控制台以无线方式向对讲机分配或从中删除新通话组。

当控制台将 DGNA 分配到您的对讲机时，对讲机将处于 DGNA 模式：

- 将发出一声提示音。
- 显示屏短暂显示 <DGNA 通话组别名 > 已分配，然后再返回到主屏幕。
- DGNA 图标出现在状态栏上。
- 主屏幕显示 DGNA 通话组别名。

当控制台从您的对讲机删除 DGNA 时，对讲机会返回到此前的通话组。

- 将发出一声提示音。
- 显示屏短暂显示 <DGNA 通话组别名 > 已删除，然后再返回到主屏幕。
- 状态栏中的 DGNA 图标消失。
- 主屏幕显示此前的通话组别名。

根据您的对讲机的预设情况，您可以查看、编辑和收听原来的扫描列表信道和非 DGNA 通话组。

当您的对讲机处于 DGNA 模式时，按 PTT 按钮可以只与当前的 DGNA 通话组通信。要与以前的非 DGNA 通话组通信，请预设单键接入按钮。请参阅[发起非 DGNA 呼叫 \(第 159 页\)](#)。



说明：

咨询经销商或系统管理员以确定对讲机的预设情况。

发起 DGNA 呼叫

当对讲机处于 DGNA 模式时，按下 **PTT** 按钮发起呼叫。

- DGNA 提示音响起。
- 显示屏显示 DGNA 图标和 DGNA 通话组别名。



说明：

如果对讲机未处于 DGNA 模式，而您按下**单键接入**按钮，则对讲机会发出提示音，指示出现错误。显示屏保持不变。

发起非 DGNA 呼叫

- 1 按预设的**单键接入**按钮。
 - 设备会发出一声确定提示音。
 - 对讲机发出语音提示音：单键替换呼叫。
 - 显示屏短暂显示 <通话组别名> 和按 PTT。



说明：

如果对讲机未处于 DGNA 模式，而您按下**单键接入**按钮，则对讲机会发出否定提示音，指示出现错误。显示屏保持不变。

- 2 在否定提示音响起之前按下 **PTT** 按钮，对讲机会返回到主屏幕。



说明：

当对讲机处于主屏幕时，按下 PTT 会向 DGNA 通话组发起呼叫。

接收和响应 DGNA 呼叫

当您接收 DGNA 呼叫时：

- DGNA 提示音响起。
- 显示屏显示 DGNA 图标、DGNA 通话组别名和对讲机别名。
- 对讲机取消静音，呼入电话会通过扬声器发出声音。

- 1 按 **PTT** 来回复该呼叫。

- 2 释放 **PTT** 按钮接听。

实用工具

本章介绍对讲机中可用的实用功能操作。

功率级别

您可以将每个信道的功率设置自定义为高或低。

高

该设置用于与距离相对较远的对讲机进行通信。

低

该设置用于与较近处的对讲机进行通信。



说明：



此功能不适用于频率相同的民用频段信道。



设置功率级别

按照步骤在对讲机上设置功率级别。

1 执行以下操作之一：

- 按下预设的**功率级别**按钮。跳过以下步骤。
- 按  访问菜单。

2 按  或  显示设置。按  进行选择。

3 按  或  显示对讲机设置。按  进行选择。

4 按  或  显示功率。按  进行选择。

5 执行以下操作之一：



- 按  或  显示高。按  进行选择。显示屏在高旁边显示 。
- 按  或  显示低。按  进行选择。显示屏在低旁边显示 。



6 长按  返回主屏幕。



打开或关闭对讲机音调/提示



如果需要，您可以启用和禁用所有对讲机提示音和提示，但传入紧急呼叫提示音除外。按照步骤打开或关闭对讲机上的音调和提示。

- 1 执行以下操作之一：
 - 按预设的**提示音/提示**按钮。跳过以下步骤。
 - 按  访问菜单。



- 2 按  或  显示设置。按  进行选择。

- 3 按  或  显示对讲机设置。按  进行选择。

- 4 按  或  显示音调/提示。按  进行选择。

- 5 按  或  显示全部音调。按  进行选择。



- 6 按  以启用或禁用全部音调和提示。屏幕将显示以下结果之一：



- 如果启用，已启用旁出现 。
- 如果禁用，已启用旁的  消失。

打开或关闭键盘音



按照步骤打开或关闭对讲机的键盘音。



- 1 按  访问菜单。

- 2 按  或  显示设置。按  进行选择。

- 3 按  或  显示对讲机设置。按  进行选择。

- 4 按  或  显示音调/提示。按  进行选择。



- 5 按  或  显示键盘音。按  进行选择。



- 按  启用或禁用键盘音。屏幕将显示以下结果之一：
 - 如果启用，已启用旁出现 。
 - 如果禁用，已启用旁的  消失。



设置音调/提示音量偏移度

此功能调节提示音或提示的音量，允许它比语音音量高一些或低一些。按照步骤在对讲机上设置提示音和提示的音量偏移度。

- 按  访问菜单。
- 按  或  显示设置。按  进行选择。
- 按  或  显示对讲机设置。按  进行选择。
- 按  或  显示音调/提示。按  进行选择。





- 按  或  显示音量偏移。按  进行选择。



- 按  或  显示所需的音量偏移度。反馈提示音随每个相应的音量偏移度响起。



- 执行以下操作之一：
 - 按  进行选择。已保存所需的音量偏移度。
 - 按  退出。放弃更改。

打开或关闭通话许可提示音



按照步骤打开或关闭对讲机的通话许可提示音。



- 按  访问菜单。
- 按  或  显示设置。按  进行选择。
- 按  或  显示对讲机设置。按  进行选择。



4 按  或  显示音调/提示。按  进行选择。

5 按  或  显示通话许可。按  进行选择。

6 按  启用或禁用通话许可音。
屏幕将显示以下结果之一：



- 如果启用，已启用旁出现 。
- 如果禁用，已启用旁的  消失。

3 按  或  显示对讲机设置。按  进行选择。

4 按  或  显示音调/提示。按  进行选择。

5 按  或  显示电源开。按  进行选择。



6 按  启用或禁用开机提示音。屏幕将显示以下结果之一：

- 如果启用，已启用旁出现 。
- 如果禁用，已启用旁的  消失。

打开或关闭开机音

按照步骤打开或关闭对讲机的开机音。

1 按  访问菜单。



2 按  或  显示设置。按  进行选择。



设置短信提示音

您可以将通讯录列表中各条目的短信提示音自定义为瞬间音或重复音。按照步骤在对讲机上设置短信提示音。

1 按  访问菜单。

2 按  或  显示通讯录。按  进行选择。

3 按  或  显示所需的别名或 ID。按  进行选择。

4 按  或  显示短信提示音。按  进行选择。

5 执行以下操作之一：



- 按  或  显示瞬间。按  进行选择。
显示屏在瞬间旁边显示 。
 - 按  或  显示重复。按  进行选择。
显示屏在重复旁边显示 。
-



更改显示模式



您可以根据需要将对讲机的显示模式更改为日间显示模式或晚间显示模式。该功能将影响屏幕的颜色配置。按照步骤更改对讲机显示模式。





- 1 执行以下操作之一：
 - 按预设的**显示模式**按钮。跳过以下步骤。

- 按  访问菜单。
-

2 按  或  显示设置。按  进行选择。

3 按  或  显示对讲机设置。按  进行选择。

4 按  或  至显示。按  进行选择。
屏幕显示日间模式和夜间模式。



5 按  或  显示所需的设置。按  进行选择。
显示屏在所选的设置旁显示 。



调节显示屏亮度



按照步骤在对讲机上调节显示屏亮度。激活“自动亮度”时，无法调节屏幕亮度。



- 1 执行以下操作之一：
 - 按预设的**亮度**按钮。跳过以下步骤。

- 按  访问菜单。

2 按  或  显示设置。按  进行选择。

3 按  或  显示对讲机设置。按  进行选择。

4 按  或  显示亮度。按  进行选择。
显示屏显示进度条。



5 按  或  显示降低或增加显示屏亮度。按  进行选择。
设置值的范围为 1 到 8。



打开/关闭喇叭/灯



对讲机可通过喇叭和灯光功能做出呼入电话提示。激活时，呼入电话使喇叭响起并打开车辆上的指示灯。该功能需要由您的经销商通过对讲机后部的附件接口来安装。按照步骤打开或关闭对讲机上的所有喇叭和指示灯。

1 执行以下操作之一：



- 按预设的喇叭/灯按钮。跳过以下步骤。
- 按  访问菜单。

2 按  或  显示设置。按  进行选择。

3 按  或  显示对讲机设置。按  进行选择。

4 按  或  显示喇叭/灯。按  进行选择。

5 按  启用/禁用喇叭/灯。屏幕将显示以下结果之一：

- 如果启用，已启用旁出现 。
- 如果禁用，已启用旁的  消失。

打开或关闭 LED 指示灯

按照步骤打开或关闭对讲机上的 LED 指示灯。

- 1 按  访问菜单。

- 2 按  或  显示设置。按  进行选择。

- 3 按  或  显示对讲机设置。按  进行选择。

- 4 按  或  显示 LED 指示灯。按  进行选择。

- 5 按  启用或禁用 LED 指示灯。
屏幕将显示以下结果之一：
 - 如果启用，已启用旁出现 。
 - 如果禁用，已启用旁的  消失。

打开或关闭公共广播系统

按照步骤来启用或禁用您的对讲机的内部公共广播 (PA) 系统。

- 1 执行以下操作之一：
 - 按预设的**公共广播**按钮。跳过以下步骤。
 - 按  访问菜单。

- 2 按  或  显示设置。按  进行选择。

- 3 按  或  显示对讲机设置。按  进行选择。



- 4 按  或  显示公共广播。按  进行选择。



- 5 按  以启用或禁用公共广播。
 - 如果启用，已启用旁出现 。
 - 如果禁用，已启用旁的  消失。



打开或关闭外部公共广播系统



按照步骤来启用或禁用您的对讲机的外部公共广播 (PA) 系统。

- 1 执行以下操作之一：
 - 按预设的**外部公共广播**按钮。跳过以下步骤。
 - 按  访问菜单。

- 2 按  或  显示设置。按  进行选择。

- 3 按  或  显示对讲机设置。按  进行选择。

- 4 按  或  显示外部公共广播。按  进行选择。

- 5 按  启用或禁用外部公共广播。
 - 如果启用，已启用旁出现 。
 - 如果禁用，已启用旁的  消失。

打开或关闭开机界面

您可按照步骤启用和禁用开机界面。

- 1 按  访问菜单。

- 2 按  或  显示设置。按  进行选择。

- 3 按  或  显示对讲机设置。按  进行选择。

- 4 按  或  显示显示。按  进行选择。

- 5 按  或  显示开机界面。按  进行选择。

- 6 按  启用或禁用开机界面。
屏幕将显示以下结果之一：
 - 如果启用，已启用旁出现 。
 - 如果禁用，已启用旁的  消失。

设置语言

按照步骤在对讲机上设置语言。

- 1 按  访问菜单。

- 2 按  或  显示设置。按  进行选择。

- 3 按  或  显示对讲机设置。按  进行选择。

- 4 按  或  显示语言。按  进行选择。

- 5 按  或  显示所需的语言。按  进行选择。
显示屏在所选语言旁边显示 。

识别线缆类型

执行以下步骤以选择对讲机使用的线缆类型。

- 1 按  访问菜单。

- 2 按  或  显示设置。按  进行选择。

- 3 按  或  显示对讲机设置。按  进行选择。

- 4 按  或  显示线缆类型。按  进行选择。

- 5 当前线缆类型以  表示。

打开或关闭语音提示

此功能使对讲机可以通过语音方式指示用户刚刚分配的当前区域或信道或者用户刚按下的可编程按钮。当用户难以阅读屏幕上显示的内容时，此功能通常非常有用。

可根据客户需求对此语音提示进行自定义。按照步骤打开或关闭对讲机的语音提示。

打开或关闭选件板

可将每个信道中的选件板功能分配给可预设按钮。一个信道可以支持多达 6 个选件板功能。按照步骤打开或关闭对讲机上的选件板。

按下预设的**选件板**按钮。

文本转语音

文本转语音功能仅能由您的经销商或系统管理员启用。如果文本转语音已启用，则语音提示功能会自动被禁用。如果语音提示已启用，那么将自动禁用文本转语音功能。

此功能让对讲机可以通过语音方式指示以下功能：

- 当前信道
- 当前区域
- 打开或关闭预设的按钮功能
- 收到的短信的内容
- 收到的任务的内容

此音频指示器可根据客户需求进行自定义。当用户难以阅读屏幕上显示的内容时，此功能通常非常有用。

设置文本转语音

按照步骤设置文本转语音功能。

- 1 按  访问菜单。

- 2 按  或  显示设置。按  进行选择。

- 3 按  或  显示对讲机设置。按  进行选择。

- 4 按  或  显示语音提示。按  进行选择。

- 5 按  或  显示以下任何功能。按  进行选择。





可用功能如下所示：



- 全部
- 信息



- 任务
 - 信道
 - 区域
 - 编程按钮
- ✓ 出现在所选设置旁边。

设置菜单计时器

您可以设置对讲机在自动切换至主屏幕前在菜单中所停留的时间。按照步骤设置菜单计时器。

- 1 按  访问菜单。
- 2 按  或  显示设置。按  进行选择。
- 3 按  或  显示对讲机设置。按  进行选择。
- 4 按  或  至显示。按  进行选择。







- 5 按  或  至菜单限时器。按  进行选择。



- 6 按  或  显示所需的设置。按  进行选择。

打开或关闭数字麦克风 AGC

在数字系统中发射信号时，数字麦克风自动增益控制 (AGC) 自动控制对讲机的麦克风增益。



此功能会抑制高频或提升低频以将音频保持在预设的值，从而实现一致的音频水平。按照步骤打开或关闭对讲机上的数字麦克风 AGC。

- 1 按  访问菜单。
- 2 按  或  显示设置。按  进行选择。
- 3 按  或  显示对讲机设置。按  进行选择。



4 按  或  显示麦克风 AGC-D。按  进行选择。



5 按  启用或禁用数字麦克风 AGC。



屏幕将显示以下结果之一：

- 如果启用，已启用旁出现 。
- 如果禁用，已启用旁的  消失。

- 按  访问菜单。

2 按  或  显示设置。按  进行选择。

3 按  或  显示对讲机设置。按  进行选择。

4 按  或  显示智能音频。按  进行选择。

5 执行以下操作之一：

- 按  或  显示开。按  进行选择。显示屏在开旁边显示 。
- 按  或  显示关。按  进行选择。显示屏在关旁边显示 。

打开或关闭智能音频

您的对讲机会自动调整音量以克服环境中当前存在的背景噪音（包括静态和非静态噪音源）。此功能只对接收的音频有效，不会影响发射的音频。按照步骤打开或关闭对讲机上的智能音频。



说明：

此功能在进行蓝牙会话时不适用。



1 执行以下操作之一：



- 按预设的**智能音频**按钮。跳过以下步骤。



打开或关闭回声抑制器功能



通过此功能可以最小化您在接听电话时遇到的回声。

1 按  访问菜单。





2 按  或  显示实用程序，然后按  进行选择。

3 按  或  至对讲机设置，然后按  进行选择。

4 按  或  显示 AF 抑制器，然后按  进行选择。

您也可以使用  或  按钮更改所选选项。

5 执行以下操作之一。



- 按  启用回声抑制器。显示屏在已启用旁边显示 。
 - 按  禁用回声抑制器。已启用旁边的  消失。
-



打开或关闭抖音增强功能



当您以包含许多唇齿抖音（卷舌“R”）发音的语言说话时，可以启用此功能。按照步骤打开或关闭对讲机上的抖音增强。

1 执行以下操作之一：

- 按预设的**抖音增强**按钮。跳过以下步骤。
 - 按  访问菜单。
-

2 按  或  显示设置。按  进行选择。

3 按  或  显示对讲机设置。按  进行选择。

4 按  或  显示抖音增强。按  进行选择。

5 执行以下操作之一：

- 按  或  显示开。按  进行选择。显示屏在开旁边显示 。
 - 按  或  显示关。按  进行选择。显示屏在关旁边显示 。
-

音频环境

您可以根据您的环境对您的对讲机的音频环境进行自定义。

默认

这是默认设置。

大声

该设置在嘈杂的环境中启用噪声抑制器，增加扬声器的音量。



工作组



该设置使用 **AF** 抑制器和禁用 **AGC**，适合彼此靠近的一组对讲机使用。



设置音频环境



根据环境，按照步骤在对讲机上设置音频环境。

1 按  访问菜单。

2 按  或  显示设置。按  进行选择。

3 按  或  显示对讲机设置。按  进行选择。

4 按  或  显示音频环境。按  进行选择。

5 按  或  显示所需的设置。按  进行选择。

这些设置如下。

- 选择默认使用默认工厂设置。
- 在嘈杂环境下使用时，选择响亮以增加扬声器的音量。
- 使用彼此靠近的一组对讲机时，选择工作组以减少回声。

显示屏在所选的设置旁显示 。

音频配置文件

您可以根据您的偏好对您的对讲机的音频配置文件进行自定义。

默认

这是默认设置。

级别 1、级别 2 和级别 3

这些设置旨在补偿噪音导致的 40、50、60 及以上年龄段成年人通常会有听力减退。

高音增强、中音增强和低音增强

这些设置旨在实现更微小的声音、鼻音更重的声音和更低沉的声音。

设置音频配置文件

按照步骤在对讲机上设置音频配置文件。

- 1 按  访问菜单。
- 2 按  或  显示设置。按  进行选择。
- 3 按  或  显示对讲机设置。按  进行选择。
- 4 按  或  显示音频配置文件。按  进行选择。
- 5 按  或  显示所需的设置。按  进行选择。

这些设置如下。

- 选择默认以禁用之前选定的音频配置文件并返回至默认工厂设置。
- 为音频配置文件选择级别 1、级别 2 或级别 3，旨在补偿 40 岁以上成人通常将面临的噪音导致的听力减退。
- 为音频配置文件选择高音增强、中音增强或低音增强，以便符合适用于尖细的声音、鼻音较重的声音和更深的声音的偏好。

显示屏在所选的设置旁显示 。

打开或关闭全球导航卫星系统

全球导航卫星系统 (GNSS) 是一种卫星导航系统，用于确定对讲机的精确位置。GNSS 包括全球定位系统 (GPS) 和 BeiDou 导航卫星系统 (BDS)。









说明：



所选型号的对讲机可提供 GPS 和 BDS。GNSS 卫星群可使用 CPS 配置。咨询经销商或系统管理员以确定对讲机的预设情况。

- 1 请执行以下步骤打开或关闭对讲机的 GNSS。
 - 按预设的 **GNSS** 按钮。

- 按  访问菜单。继续下一步骤。

2 按  或  显示设置。按  进行选择。

3 按  或  显示对讲机设置。按  进行选择。

4 按  或  显示 GNSS。按  进行选择。

5 按  启用或禁用 GNSS。

如果启用，已启用旁出现 。

如果禁用，已启用旁的  消失。

一般对讲机信息

对讲机包含有关各种常规参数的信息。

对讲机的一般信息如下所示：



- 对讲机别名和 ID。
- 固件和 Codeplug 版本。
- 软件更新。

- GNSS 信息。

- 站点信息。



说明：

按  返回前一屏幕。长按  返回主屏幕。不活动计时器超时后，对讲机退出当前屏幕。

查看对讲机别名和 ID



按照步骤查看对讲机上的对讲机别名和 ID。



1 执行以下操作之一：



- 按预设的**对讲机别名和 ID**按钮。跳过以下步骤。发出一声确定提示音。

您可以按下预设的**对讲机别名和 ID**按钮以返回前一屏幕。

- 按  访问菜单。

2 按  或  显示设置。按  进行选择。

3 按  或  显示对讲机信息。按  进行选择。

- 按  或  显示我的 ID。按  进行选择。
第一行文字显示对讲机别名。第二行文字显示对讲机 ID。

检查固件版本和 Codeplug 版本

按照步骤检查对讲机上的固件版本和 Codeplug 版本。

- 按  访问菜单。
- 按  或  显示设置。按  进行选择。
- 按  或  显示对讲机信息。按  进行选择。
- 按  或  显示版本。按  进行选择。
屏幕显示当前固件和 Codeplug 版本。

检查软件更新信息

此功能显示通过 OTAP 或 Wi-Fi 执行的最新软件更新的日期和时间。按照步骤检查对讲机上的软件更新信息。

- 按  访问菜单。
- 按  或  显示设置。按  进行选择。
- 按  或  显示对讲机信息。按  进行选择。
- 按  或  显示软件更新。按  进行选择。
屏幕显示最新软件更新的日期和时间。

软件更新菜单仅在至少进行一次成功的 OTAP 或 Wi-Fi 会话后才可用。有关详细信息，请参阅[无线编程 \(第 384 页\)](#)。



检查 GNSS 信息



在对讲机上显示 GNSS 信息，如以下值：

- 纬度



- 经度
- 高度
- 方向
- 速率
- 水平精度因子 (HDOP)
- 卫星
- 版本

1 按  访问菜单。

2 按  或  显示设置。按  进行选择。

3 按  或  显示对讲机信息。按  进行选择。



4 按  或  显示 GNSS 信息。按  进行选择。



5 按  或  显示所需的项目。按  进行选择。显示屏显示所请求的 **GNSS** 信息。



显示站点信息

按照步骤显示对讲机打开后当前站点的名称。

1 按  访问菜单。

2 按  或  显示设置。按  进行选择。

3 按  或  显示对讲机信息。按  进行选择。



4 按  或  显示站点信息。按  进行选择。



屏幕显示当前站点名称。

查看企业 Wi-Fi 证书详细信息



您可以查看选定企业 Wi-Fi 证书的详细信息。

1 按  访问菜单。

2 按  或  显示设置。按  进行选择。

3 按  或  至证书菜单。按  进行选择。

✓ 出现在就绪证书旁边。

4 按  或  显示所需证书。按  进行选择。

对讲机显示证书的完整详细信息。



说明:

对于未就绪证书，显示屏仅显示“状态”。

Connect Plus 操作

Connect Plus 是基于 DMR 技术的 FULL 集群解决方案。Connect Plus 使用专用控制信道进行信道请求和分配。本章说明对讲机用户在本系统中可以使用的功能。

在 Connect Plus 模式下的附加对讲机控件

本章介绍通过预设的方法向对讲机用户提供的附加对讲机控件，如可预设按钮和可分配对讲机功能。

通话按键 (PTT)

对讲机侧面的**通话按键**有两个基本用途：

- 正在进行呼叫时，**通话按键**可让对讲机向该呼叫中的其他对讲机发射信号。
按住**通话按键**进行通话。释放**通话按键**接听。
按下**通话按键**时，可激活麦克风。
- 当不进行呼叫时，**通话按键**用于发起一次新呼叫（请参阅[发起对讲机呼叫 \(第 193 页\)](#)）。

如果激活了通话许可音功能，等待短提示音结束后即可开始通话。

可预设按钮

经销商可以对可预设按钮进行预设，根据按下按钮时间的长短，可预设按钮可用作对讲机功能的快捷方式：

短按

快速按下并释放。

长按

按住然后保持预设的时间。



说明：

按钮的预设持续时间适用于所有可分配对讲机/实用功能或设置。请参阅[紧急操作 \(第 220 页\)](#)详细了解[紧急呼叫按钮](#)的预设持续时间。

可分配的对讲机功能

蓝牙® 音频切换

在内部对讲机扬声器和已启用蓝牙功能的外部附件之间切换音频路由。

蓝牙连接

启动蓝牙查找并连接操作。

蓝牙断开

终止您的对讲机和任何已启用蓝牙的设备之间的所有现有蓝牙连接。

蓝牙可发现

使对讲机进入蓝牙可发现模式。

繁忙队列取消

在繁忙队列中发起非紧急呼叫时退出繁忙模式。接受进入繁忙队列后，紧急呼叫无法取消。

通话记录

选择通话记录列表。

信道通知

播放当前信道的区域和信道语音通知信息。

通讯录

用于直接访问通讯录列表。

打开/关闭紧急呼叫

根据预设，发起或取消紧急呼叫。

喇叭/灯

打开或关闭喇叭和灯功能。

室内定位

打开或关闭室内定位。

智能音频

打开或关闭智能音频。

手动拨号

根据编程，通过键入任何用户 ID 或电话号码，您可以启动个别呼叫或电话呼叫。

单键接入

直接发起预定义的单呼、呼叫提示、预制短信或复原返回。

加密

打开或关闭加密。

对讲机检测

确定系统内的对讲机是否激活。

对讲机激活

允许远程启用目标对讲机。

对讲机遥控

允许远程禁用目标对讲机。

远程监听

开启目标对讲机的麦克风，而不点亮任何指示灯。

重置主信道

设置新的主信道。

铃声提示类型

提供对铃声提示类型设置的直接访问。

漫游请求

请求搜索其他站点。

扫描

打开或关闭扫描。

静音主信道提醒

静音主信道提醒。

站点锁定开/关

切换为打开时，对讲机只搜索当前站点。切换为关闭时，对讲机将搜索当前站点和其他站点。

短信

选择短信菜单。

语音提示开/关

打开或关闭语音提示。

Wi-Fi

打开或关闭 Wi-Fi。

区域

允许从区域列表中选择。

可分配的设置或实用功能

AF Suppressor

打开或关闭回声抑制器功能。

全部音调/提示

打开或关闭全部音调和提示。

背光亮度

调整亮度。

信道上调/下调

根据预设，将信道切换至上一信道或下一信道。

显示模式

在日间/夜间显示模式之间进行切换。

全球导航卫星系统 (GNSS)

打开或关闭卫星导航系统。

功率级别

在高低功率之间切换发射功率级别。

未分配

指示按钮功能尚未分配。

在 **Connect Plus** 模式中识别状态指示灯

显示屏图标

以下是出现在对讲机屏幕上的图标。



接收信号强度指示器 (RSSI)

显示的信号强度柱数目表示对讲机信号强度。四个信号强度柱表示信号的强度最强。只有在接收时才显示该图标。

	<p>未连接蓝牙</p> <p>蓝牙功能已启用，但尚未连接远程蓝牙设备。</p>
	<p>蓝牙已连接</p> <p>蓝牙功能已启用。当连接了一个远程蓝牙设备时，此图标将保持亮起状态。</p>
	<p>大批量数据</p> <p>对讲机正在接收大批量数据，信道处于繁忙状态。</p>
	<p>室内定位可用⁴</p> <p>室内定位状态已打开并可用。</p>
	<p>室内定位不可用⁴</p> <p>室内定位状态已打开但不可用，这是因为蓝牙已禁用或信标扫描通过蓝牙挂起。</p>
	<p>静音模式</p> <p>静音模式已启用，扬声器已静音。</p>
	<p>通知</p>

	<p>通知列表中包含可查看的项目。</p>
	<p>功率级别</p> <p>对讲机设在低功率级别或对讲机设在高功率级别。</p>
	<p>提示音禁用</p> <p>提示音已关闭。</p>
	<p>选件板</p> <p>选件板已启用。</p>
	<p>选件板不工作</p> <p>选件板已禁用。</p>
	<p>GNSS 可用</p> <p>GPS/GNSS 功能已启用。定位可用时，该图标亮起。</p>
	<p>GNSS 不可用/超出范围</p> <p>GPS/GNSS 功能已启用，但未接收到卫星数据。</p>

⁴ 仅适用于具有最新软件和硬件的型号

	<p>仅 BeiDou 可用⁵</p> <p>已启用仅 BeiDou 功能。定位可用时，该图标亮起。</p>
	<p>扫描</p> <p>扫描功能已启用。</p>
	<p>紧急呼叫</p> <p>对讲机处于紧急呼叫模式。</p>
	<p>安全</p> <p>加密功能已启用。</p>
	<p>不安全</p> <p>加密功能已禁用。</p>
	<p>站点漫游</p> <p>已启用站点漫游功能。</p>
	<p>联系人</p> <p>对讲机联系人可用。</p>



	<p>通话记录</p> <p>对讲机通话记录。</p>
	<p>消息</p> <p>收到的信息。</p>
	<p>仅响铃</p> <p>已激活铃声模式。</p>
	<p>静音</p> <p>已激活静音模式。</p>
	<p>振动</p> <p>已激活振动模式。</p>
	<p>铃音和振动</p> <p>已激活铃音和振动模式。</p>
	<p>Wi-Fi 极佳⁶</p> <p>Wi - Fi 信号极佳。</p>
	<p>Wi-Fi 良好⁶</p> <p>Wi-Fi 信号良好。</p>



⁵ 仅适用于 XiR M8660i/XiR M8668i/CM7668i

	Wi-Fi 中等 ⁶ Wi-Fi 信号中等。
	Wi-Fi 较差 ⁶ Wi-Fi 信号弱。
	Wi-Fi 不可用 ⁶ Wi-Fi 信号不可用。

呼叫图标

以下图标将在呼叫过程中出现在对讲机显示屏上。这些图标也出现在通讯录列表中，用于指示 ID 类型。

	单呼 表示正在进行单呼。在“通讯录”列表中，它表示用户别名（名称）或 ID（编号）。
	组呼/站点全呼

	表示正在进行组呼或站点全呼。在“通讯录”列表中，它表示通话组别名（名称）或 ID（编号）。
	单呼电话呼叫 表示正在进行“单呼电话呼叫”。
	蓝牙 PC 呼叫 表示正在进行蓝牙 PC 呼叫。 在“通讯录”列表中，它表示蓝牙 PC 呼叫别名（名称）或 ID（编号）。
	调度呼叫 调度呼叫联系人类型用于通过第三方短信服务器给调度员 PC 发送短信。

⁶ 仅适用于 XiR M8668i/CM7668i

高级菜单图标

以下图标显示在菜单项旁边，这些图标供用户在两个选项之间进行选择或者向用户表明有一个可提供两个选项的子菜单。

	复选框（未选中） 表示未选中该选项。
	复选框（选中） 表示选中该选项。
	实心黑框 表示为包含子菜单的菜单项所选择的选项。

已发信息图标

以下图标显示在对讲机显示屏右上角的“已发信息”文件夹中。

	发送成功 短信已成功发送。
或 	
	进行中
或 	<ul style="list-style-type: none"> 至某一通话组别名或 ID 的短信正在等待发送。 至某一用户别名或 ID 的短信正在等待发送，然后等待确认。
	已读单条或群组信息 已读短信。
或 	
	未读单条或群组信息 短信未读。



发送失败

短信尚未发送。

或



蓝牙设备图标

以下图标也显示在已启用蓝牙功能的可用设备列表中的列表项旁边，用于表示设备类型。



蓝牙数据设备

已启用蓝牙功能的数据设备，例如扫描器。



蓝牙音频设备

已启用蓝牙功能的音频设备，例如耳机。



蓝牙 PTT 设备

已启用蓝牙功能的 PTT 设备，例如仅具备 PTT 功能的设备 (POD)。

LED 指示灯

LED 指示灯显示对讲机的工作状态。

红灯闪烁

对讲机正在低电池电量状态下发射、接收紧急呼叫发射信号或开机后自检失败，或者已移至范围以外（如果对讲机配置了自动范围应答系统）。已启用静音模式。

红灯快速闪烁

对讲机正在接收无线文件传输（选件板固件文件、网络频率文件或选件板 Codeplug 文件）或正在升级到新的选件板固件文件。

绿灯和黄灯闪烁

对讲机正在接收呼叫提示、接收到短信或扫描已启用并且正在接收活动。

黄灯长亮

对讲机处于蓝牙可发现模式。

黄灯双闪

对讲机正在主动搜索新站点。

黄灯闪烁

对讲机正在接收呼叫提示或扫描已启用并且待机（对讲机将对任何活动保持静音）。

绿灯长亮

对讲机正在开机或正在发射信号。

绿灯闪烁

对讲机正在开机、接收呼叫或数据。

绿灯双闪 对讲机正在接收加密呼叫。

提示音

以下是通过对讲机扬声器发出的提示音。

高音调提示音  低音调提示音 

在采取执行任务的操作后，提示音为您提供状态的声音提示。

 确定提示音

 否定提示音

提示音

提示音通过声音向您发出有关对讲机状态或对讲机对所接收的数据进行的响应的提示。

连续音  发出单调音。连续发音直至终止。

周期音  根据对讲机设定的持续时间周期发音。铃音自我启动、停止和重复。

重复音  自我重复的单音，直至用户将其终止。

瞬间音  仅短时发音一次，时间长短由对讲机定义。

在 **Connect Plus** 和非 **Connect Plus** 模式之间切换

如果经销商或系统管理员已经进行预设，则要切换到非 **Connect Plus** 模式时，您必须更改至另一区域。咨询经销商或系统管理员以检查对讲机是否预设非 **Connect Plus** 区域以及在非 **Connect Plus** 区域中工作时可以使用的功能。

在 Connect Plus 模式下发起和接收呼叫

本节介绍对讲机上可用的常规对讲机操作和呼叫功能。

选择站点

站点会覆盖特定区域。Connect Plus 站点具有站点控制器和最多 15 台中继器。在多站点网络中，Connect Plus 对讲机会在当前站点的信号等级降低至无法接受的等级时自动搜索新站点。

漫游请求

漫游请求会使对讲机搜索其他站点，即使当前站点的信号可接受。

若无站点可用：

- 对讲机显示正在搜索和选定信道别名并继续搜索站点列表。
- 如果以前的站点仍可用，对讲机将返回上一个站点。



说明：
该功能已由经销商进行预设。

按预设的**漫游请求**按钮。

您将听到提示音，表示对讲机已切换到新站点。显示屏显示站点 ID <站点编号>。

站点锁定开/关

切换为打开时，对讲机只搜索当前站点。切换为关闭时，对讲机将搜索当前站点和其他站点。

按预设的**站点锁定**按钮。

如果**站点锁定**功能切换为开启：

- 您将听到确定提示音，表示对讲机已锁定到当前站点。
- 屏幕显示站点已锁定。

如果**站点锁定**功能切换为关闭：

- 您会听到否定提示音，表示对讲机已解锁。
- 屏幕显示站点已解锁。

站点限制

Connect Plus 对讲机系统管理员能够确定允许对讲机使用和不允许对讲机使用的网络站点。对讲机无需重新预设即可更改允许和不允许站点列表。如果对讲机尝试在不允许的站点上注册，您将看到这样的短消息：站点 <指定编号> 不允许。然后对讲机会搜索其他网络站点。



选择区域

对讲机最多可预设 16 个 **Connect Plus** 区域并且每个 **Connect Plus** 区域在信道选择旋钮上最多包含 16 个可分配的位置。

每个可分配的旋钮位置可用于发起以下语音呼叫类型的一种：





- 组呼
- 多组呼
- 站点全呼
- 单呼

1 通过执行以下操作访问区域功能：

对讲机控件	步骤
预设的区域选择按钮	按预设的 区域选择 按钮。
对讲机菜单	<p>a 按  访问菜单。</p> <p>b 按  或  显示区域，然后按  进行选择。</p>

当前区域将会显示，并以  指示。

2 选择所需区域。

对讲机控制	步骤
 或 	按  或  ，然后滚动到所需区域。

3 按  进行选择。

显示屏短暂显示<区域> 已选择，然后返回所选区域屏幕。

使用多个网络

如果对讲机预设为使用多个 **Connect Plus** 网络，您可以通过切换至分配到所需网络的 **Connect Plus** 区域选择其他网络。这些网络到区域的分配由经销商通过对讲机编程配置。

选择呼叫类型

使用信道选择旋钮选择呼叫类型。呼叫类型可以是组呼、多组呼、站点全呼或单呼，具体取决于对讲机的预设情况。如果更改信道选择旋钮到另一个位置（已分配一个呼叫类型），这样会导致对讲机在 **Connect Plus** 站点重新注册。对讲机使用新信道选择旋钮位置呼叫类型预设的注册组 ID 注册。

如果选择未分配呼叫类型的位置，对讲机会发出连续提示音并且屏幕显示未编程信道。由于选定未预设的信道时对讲机不工作，所以需要使用信道选择旋钮选择预设的信道。

所需区域显示后（如果对讲机中有多个区域），转动预设的信道选择旋钮以选择呼叫类型。

接收和回复对讲机呼叫

在信道、用户 ID 或呼叫类型显示后，您可以接收并回复呼叫。

当对讲机发射时 LED 绿灯长亮，对讲机接收时为绿灯闪烁。



说明：

当对讲机发射时 LED 绿灯长亮，当对讲机接收加密呼叫时，LED 绿灯快闪。要对加密呼叫进行解密，您的对讲机必须拥有与发射对讲机（您从其接收呼叫的对讲机）相同的加密密钥，或相同的密钥值和密钥 ID（经销商进行了预设）。

有关详细信息，请参阅[加密 \(第 235 页\)](#)。

接收和回复组呼

要接收来自用户组的呼叫，对讲机必须配置为属于该通话组。

当您接收组呼（在主屏幕上）时，LED 绿灯闪烁。组呼图标出现在右上角。第一行文字显示呼叫方别名。第二行文字显示组呼别名。您的对讲机取消静音，有对讲机呼入时对讲机会通过扬声器发出声音。

- 1 请握住对讲机，并与嘴保持 1 到 2 英寸（2.5 到 5.0 厘米）的距离。

LED 绿灯长亮。

2 等待一个通话许可提示音结束后（启用该功能时）对着麦克风清楚地讲话。

3 释放 **PTT** 按钮接听。

如果在预定时间内无语音活动，则呼叫终止。



说明：

有关组呼的详细信息，请参阅[发起组呼 \(第 194 页\)](#)。

接收和回复单呼

单呼是由一台个体对讲机对另一台个体对讲机的呼叫。

当您接收单呼时，LED 绿灯闪烁。屏幕第一行显示用户别名或 ID 以及 RSSI 图标。第二行显示单呼和单呼图标。对讲机取消静音，呼入电话会通过对讲机的扬声器发出提示音。

1 请握住对讲机，并与嘴保持 **1 到 2 英寸（2.5 到 5.0 厘米）** 的距离。

2 按 **PTT** 来回复该呼叫。

LED 绿灯长亮。

3 等通话许可提示音结束后（启用该功能时）对着麦克风清楚地讲话。

4 释放 **PTT** 按钮接听。

如果在预定时间内无语音活动，则呼叫终止。

屏幕显示呼叫结束。

有关单呼的详细信息，请参阅[发起单呼 \(第 194 页\)](#)。

接收站点全呼

站点全呼是单个对讲机到站点上每部对讲机的呼叫。用于发布需要用户特别关注的重要通告。

当您接收站点全呼时，发出一声提示音，且 LED 绿灯闪烁。

组呼图标出现在右上角。第一行文字显示呼叫方别名。第二行文字显示站点全呼。您的对讲机取消静音，有对讲机呼入时对讲机会通过扬声器发出声音。

站点全呼结束后，对讲机返回接收呼叫前的屏幕。站点全呼不会等待预定时间，会直接终止。

您无法回复站点全呼。



说明:

有关进行站点全呼的详细说明, 请参阅 [进行站点全呼 \(第 195 页\)](#)。

在接收站点全呼时, 如果您切换至另一个信道, 则对讲机停止接收该站点全呼。站点全呼期间, 您将无法使用任何预设的按钮功能, 直至呼叫结束。

接收入站单呼电话

当接收到入站单呼电话时, 在右上角电话显示为单呼图标。第一行文本显示 电话。

1 按住**通话按键**进行通话。释放 **PTT** 按钮接听。

2 长按  结束通话。

屏幕第一行显示通话。屏幕第二行显示结束中...。
对讲机将返回到电话屏幕。
屏幕显示通话结束。

在入站单呼电话中发起缓冲分机拨号

在呼叫期间, 在右上角电话显示为单呼图标。屏幕第一行文字显示电话。

1 使用键盘输入数字, 然后按  按钮。

按  后在 2 秒钟内按  可插入暂停符。显示屏中 P 将替换 * 和 #。

在右上角电话显示为单呼图标。屏幕第一行文字显示输入的数字。

2 长按  结束通话。

屏幕第一行显示通话。屏幕第二行显示结束中...。
对讲机将返回到电话屏幕。
屏幕显示通话结束。

在入站单呼电话中发起实时分机拨号

在呼叫期间，在右上角电话显示为单呼图标。屏幕第一行文字显示电话。

- 1 按下**通话按钮**并使用键盘输入数字。

在右上角电话显示为单呼图标。屏幕第一行显示实时拨打数字。

- 2 长按  结束通话。

屏幕第一行显示通话。屏幕第二行显示结束中...。对讲机将返回到电话屏幕。

屏幕显示通话结束。

接收入站电话通话组呼叫

当接收入站通话组电话呼叫时，在显示屏右上角将显示组呼图标。第一行文字显示呼叫 1。

按 **PTT** 按钮进行通话，释放可接听。

入站电话多组呼

当接收到入站电话多组呼时，在显示屏右上角将显示组呼图标。第一行文本显示 多组呼。对讲机将取消静音，有呼入的多组呼时会通过对讲机扬声器发出声音。

发起对讲机呼叫

选择信道后，您可以使用以下方式选择用户别名或 ID/通话组别名或 ID：

- 信道选择旋钮。
- 预设的**单键接入按钮** - 单键接入功能使您可以轻松地对预定义 ID 发起单呼。该功能可指定给可预设按钮的短按或长按操作。您只能将一个 ID 分配给一个**单键接入按钮**。对讲机可以有多个预设的**单键接入按钮**。
- 通讯录列表（请参阅[通讯录设置 \(第 210 页\)](#)）。



说明：

您的对讲机必须激活信道上的“加密”功能才能发送加密发射信号。只有目标对讲机具有与您的对讲机相同的密钥值和密钥 ID 时，才能解密传输。

有关详细信息，请参阅[加密 \(第 235 页\)](#)。

使用信道选择旋钮进行呼叫

此功能允许对讲机用户发起不同的呼叫类型：组呼、单呼、站点全呼、多组呼。

发起组呼

要发起对用户组的呼叫，对讲机必须配置为属于该通话组。

- 1 选择具有活动的通话组别名或 ID 的信道。请参阅[选择呼叫类型 \(第 190 页\)](#)。

- 2 请握住对讲机，并与嘴保持 1 到 2 英寸（2.5 到 5.0 厘米）的距离。

- 3 按 **PTT 键**发起呼叫。

LED 绿灯长亮。“组呼”图标出现在右上角。第一行文字显示组呼别名。

- 4 等通话许可提示音结束后（启用该功能时）对着麦克风清楚地讲话。

- 5 释放 **PTT** 按钮接听。

当目标对讲机回复时，LED 绿灯闪烁，对讲机将取消静音，并通过对讲机扬声器发出回复声音。屏幕上显

示“组呼”图标、通话组别名或 ID 以及发射对讲机别名或 ID。

如果在预定时间内无语音活动，则呼叫终止。对讲机返回发起呼叫前的屏幕。

发起单呼

虽然您可以接收和/或回复由授权的单个对讲机发起的单呼，然而您的对讲机必须进行预设才能发起单呼。

如果未启用此功能，当您使用**单键接入**按钮或信道选择旋钮发起单呼时，您将听到一声否定提示音。

- 1 执行以下操作之一。

- 选择具有有效用户别名或 ID 的信道。请参阅[选择呼叫类型 \(第 190 页\)](#)。
- 按预设的**单键接入**按钮。

- 2 请握住对讲机，并与嘴保持 1 到 2 英寸（2.5 到 5.0 厘米）的距离。

- 3 按 **PTT 键**发起呼叫。

LED 绿灯长亮。单呼图标出现在右上角。第一行文字显示目标用户别名。第二行文字显示呼叫状态。

4 等通话许可提示音结束后（启用该功能时）对着麦克风清楚地讲话。

5 释放 **PTT** 按钮接听。

当目标对讲机回复时，LED 绿灯闪烁。

如果在预定时间内无语音活动，则呼叫终止。您将听见一声短提示音。屏幕显示呼叫结束。

可以预设对讲机，使其在建立单呼之前执行对讲机存在检测。如果未检测到目标对讲机，您将听到一声短暂提示音，且屏幕上出现否定性的小型通知。

进行站点全呼

此功能允许向站点上所有当前未进行其他呼叫的用户发射信号。您的对讲机必须进行预设才允许您使用该功能。

信道/站点上的用户无法回复站点全呼。

1 选择具有活动的站点全呼组别名的信道。请参阅[选择呼叫类型 \(第 190 页\)](#)。

2 请握住对讲机，并与嘴保持 1 到 2 英寸（2.5 到 5.0 厘米）的距离。

3 按 **PTT** 键发起呼叫。

LED 绿灯长亮。“组呼”图标出现在右上角。第一行文字显示站点全呼。

4 等通话许可提示音结束后（启用该功能时）对着麦克风清楚地讲话。

发起多组呼

该功能允许向多组中的所有用户发射信号。您的对讲机必须进行预设才允许您使用该功能。



说明：

组中的用户无法回复多组呼叫。

1 旋转信道选择旋钮选择多组别名或 ID。

2 按 **PTT** 键发起呼叫。

LED 绿灯长亮。屏幕显示多组别名或 ID。

等通话许可提示音结束后（启用该功能时）对着麦克风清楚地讲话。

使用单键呼叫按钮进行单呼



说明:

必须在主屏幕按可预设按钮。

单键呼叫功能允许您轻松发起对预定义单呼别名或 ID 进行单呼。该功能可指定给可预设按钮的短按或长按操作。

您只能将一个别名或 ID 分配给单键呼叫按钮。对讲机可以有多个预设的单键呼叫按钮。

- 1 按预设的**单键呼叫**按钮对预定义的单呼别名或 ID 发起单呼。

- 2 请握住对讲机，并与嘴保持 1 到 2 英寸（2.5 到 5.0 厘米）的距离。

- 3 按 **PTT 键**发起呼叫。

LED 绿灯长亮。

屏幕显示单呼别名或 ID。

- 4 等通话许可提示音结束后（启用该功能时）对着麦克风清楚地讲话。

- 5 释放 **PTT 按钮**接听。

当目标对讲机作出响应时，LED 绿灯闪烁。

如果在预定时间内无语音活动，则呼叫终止。

使用预设的手动拨号按钮进行呼叫

此功能允许对讲机用户使用可预设的手动拨号按钮发起单呼。

发起单呼

- 1 按预设的**手动拨号**按钮进入手动拨号屏幕。

屏幕显示号码：。

- 2 使用键盘输入一个新的用户别名或个人 ID。

- 3 请握住对讲机，并与嘴保持 1 到 2 英寸（2.5 到 5.0 厘米）的距离。

- 4 按 **PTT 键**发起呼叫。

LED 绿灯长亮。单呼图标出现在右上角。第一行文字显示用户别名。第二行文字显示呼叫状态。

5 等通话许可提示音结束后（启用该功能时）对着麦克风清楚地讲话。

6 释放 **PTT** 按钮接听。

当目标对讲机作出响应时，LED 绿灯闪烁。

如果在预定时间内无语音活动，则呼叫终止。您将听见一声短提示音。屏幕显示呼叫结束。

使用预设的手动拨号按钮发起出站单呼电话

1 按预设的**手动拨号**按钮进入手动拨号屏幕。

屏幕显示号码：。

2 使用键盘输入电话号码，然后按  拨打输入的号码。

按  删除任何无用的字符。按  后在 2 秒钟内

按  可插入暂停符。显示屏中 P 将替换 * 和 #。

如果成功，屏幕第一行显示电话号码。屏幕第二行显示已拨电话号码。

如果选择了无效电话号码，显示屏将显示否定性的小型通知，打电话失败、资源不可用或无效的权限。

如果在未输入电话号码时按下 ，对讲机发出一声确定提示音，紧接一声否定提示音。显示屏保持相同。



3 长按  结束通话。

屏幕第一行显示通话。屏幕第二行显示结束中...

屏幕显示通话结束。

通过电话菜单发起出站单呼电话



1 按  访问菜单。

2 按  或  显示电话，然后按  进行选择。

3 按  以选择手动拨号。

屏幕第一行显示号码，屏幕第二行显示闪烁的光标。

- 4 使用键盘输入电话号码，然后按  拨打输入的号码。

按  删除任何无用的字符。按  后在 2 秒钟内按  可插入暂停符。显示屏中 P 将替换 * 和 #。

如果成功，屏幕第一行显示电话号码。屏幕第二行显示已拨电话号码。

如果选择了无效电话号码，显示屏将显示否定性的小型通知，打电话失败、资源不可用或无效的权限。

如果在未输入电话号码时按下 ，对讲机发出一声确定提示音，紧接一声否定提示音。显示屏保持相同。

- 5 长按  结束通话。
屏幕第一行显示通话。屏幕第二行显示结束中...。
屏幕显示通话结束。

从通讯录发起出站单呼电话



说明:

如果在 MOTOTRBO Connect Plus 选件板 CPS 中禁用“电话手动拨号”，则电话号码将不会显示在菜单中。

- 1 按  访问菜单。

- 2 按  或  显示通讯录，然后按  进行选择。

- 3 按  或  显示手动拨号，然后按  进行选择。

- 4 按  或  显示电话号码，然后按  进行选择。
屏幕第一行显示号码，屏幕第二行显示闪烁的光标。

- 5 使用键盘输入电话号码，然后按  拨打输入的号码。

如果按下**通话按键**，显示屏将显示否定性的小型通知。请按 **OK** 发送，并返回上一个屏幕。

按  删除任何无用的字符。按  后在 2 秒钟内

按  可插入暂停符。显示屏中 P 将替换 * 和 #。

如果成功，屏幕第一行显示电话号码。屏幕第二行显示已拨电话号码。

如果在未输入电话号码时按下 ，对讲机发出一声确定提示音，紧接一声否定提示音。显示屏保持相同。

6 长按  结束通话。

屏幕第一行显示通话。屏幕第二行显示结束中...

屏幕显示通话结束。

等待出站单呼电话的信道授权

在发起单呼电话时，显示屏的第一行显示电话。屏幕第二行显示已拨电话号码。

呼叫连接后，在右上角电话显示为单呼图标。屏幕第一行显示电话号码。

如果失败，显示屏将显示否定性的小型通知，打电话失败、资源不可用或无效的权限。



长按  结束通话。

对讲机返回到前一屏幕。

在已连接的出站单呼电话中发起缓冲分机拨号

在呼叫期间，在右上角电话显示为单呼图标。屏幕第一行文字显示电话号码。

1 使用键盘输入这些数字。

按  删除任何无用的字符。按  后在 2 秒钟内

按  可插入暂停符。显示屏中 P 将替换 * 和 #。



显示屏第一行文本显示 外加数字，第二行文本显示输入的额外数字。

2 按  按钮。

如果按下**通话按键**，显示屏将显示否定性的小型通知。请按 **OK** 发送，并返回上一个屏幕。

在右上角电话显示为单呼图标。显示屏的第一行文本将显示电话号码，附带分机拨号数字。

3 执行以下操作之一。

- 按  对讲机将返回到电话屏幕。
- 长按  结束通话。

在已连接的出站单呼电话中发起实时分机拨号

在呼叫期间，在右上角电话显示为单呼图标。屏幕第一行文字显示电话号码。

1 按下**通话按键**并使用键盘输入数字。

在右上角电话显示为单呼图标。显示屏的第一行文本将显示电话号码，附带分机拨号数字。

2 长按  结束通话。

屏幕第一行显示通话。屏幕第二行显示结束中...

屏幕显示通话结束。

在 Connect Plus 模式下的高级功能

本章介绍对讲机中可用的功能的操作。

主信道提醒

此功能在对讲机一段时间内未设置为主信道时提供一个提醒。

如果使用 **CPS** 启用了此功能，在对讲机一段时间内未设置为主信道时，会定期响起主信道提醒提示音和语音提示，并且屏幕第一行显示非，第二行显示主信道。

您可以通过执行以下操作之一回复提醒：

- 返回主信道。
- 使用可预设按钮使提醒暂时静音。
- 使用可预设按钮设置一个新主信道。

自动降级

自动降级是系统功能，允许在某些 **Connect Plus** 系统故障情况下继续对选定组联系人发起或接收非紧急呼叫。

如果发生这些故障中的某一种，对讲机会尝试漫游到其他 **Connect Plus** 站点。该搜索过程的结果可能是对讲机找到可工作的 **Connect Plus** 站点，也可能是对讲机找到“降级信道”（如果对讲机已启用自动降级）。降级信道是中继器，通常是可工作 **Connect Plus** 站点的一部分，但是当前无法与其站点控制器或 **Connect Plus** 网络通信。在降级模式下，中继器作为单个数字中继器工作。自动降级模式仅支持非紧急组呼。自动降级模式不支持其他呼叫类型。

自动降级模式指示

对讲机使用降级信道时，大约每 **15** 秒钟您会听到间歇性的“降级提示音”（发射时除外）。您的显示屏将定期显示短消息“降级信道”。对讲机只允许选定组联系人的 **PTT**（组呼、多组呼或站点全呼）。它不允许进行其他类型的呼叫。

在降级模式下发起/接收呼叫



说明：

呼叫只能由正在监控相同降级信道并且选定到相同组的对讲机接收。呼叫不会通过网络传输给其他站点或其他中继器。

降级模式下无法使用紧急语音呼叫或紧急报警。如果在降级模式下按紧急呼叫按钮，对讲机会发出无效按键提示音。配置显示屏的对讲机还会显示消息“功能不可用”。

降级模式下无法使用单呼（对讲机到对讲机）和电话呼叫。如果尝试进行单呼，您将听到拒绝提示音。此时您应该选择所需的组联系人。其他不支持的呼叫包括远程监控、呼叫提示、对讲机检测、对讲机激活、对讲机遥毙、短信、位置更新和分组数据呼叫。

降级模式不支持增强流量信道访问 (**ETCA**)。如果两名或多名对讲机用户同时按**通话按键**（或几乎同时），两部对讲机会在松开**通话按键**时进行传输。在此情况下，接收对讲机无法识别传输。

在降级模式下发起呼叫与正常工作情况下类似。只需选择要使用的组联系人（使用对讲机正常信道选择方法），然后按**通话按键**开始呼叫。该信道有可能正在被其他组使用。如果信道正在使用，您将收到忙音并且屏幕显示“信道忙”。您可以使用对讲机的正常信道选择方法选择组、多组或站点全呼

联系人。对讲机在降级信道工作时，多组与其他组工作方式相同。呼叫只能被当前选定到相同多组的对讲机接收。

返回正常操作

如果站点在您处于降级中继器范围内时返回正常集群操作，对讲机将自动退出自动降级模式。您听到一声注册“蜂鸣声”时，对讲机即注册成功。如果处于可操作站点（未处于降级模式）范围内，可以按漫游请求按钮（如果对讲机已预设）强制对讲机搜索可用站点并注册。若无其他可用站点，对讲机将在搜索完成后返回自动降级模式。如果离开降级中继器覆盖范围，对讲机将进入搜索模式（显示屏将指示正在搜索）。













对讲机检测

如果激活，该功能可让您确定系统内是否有其他对讲机处于活动状态，且不打扰该对讲机用户。无语音或可视通知出现在目标对讲机上。

该功能仅对用户别名或 ID 适用。

发送对讲机检测

- 1 访问对讲机检测功能。

对讲机控制	步骤
预设的对讲机检测按钮	<p>a 按下预设的对讲机检测按钮。</p> <p>b 按  或  显示所需用户别名或 ID，然后按  进行选择。</p>
菜单	<p>a 按  访问菜单。</p> <p>b 按  或  显示通讯录，然后按  进行选择。</p> <p>c 按  或  显示所需用户别名或 ID，然后按  进行选择。</p> <p>d 按  或  显示对讲机检测，然后按  进行选择。</p>

屏幕显示目标对讲机别名，指示正在处理该请求。
LED 绿灯长亮。

2 等待确认。

如果目标对讲机在系统内处于活动状态，会发出提示音并且屏幕短暂显示目标对讲机已应答。

如果目标对讲机在系统内未处于活动状态，会发出提示音并且屏幕短暂显示目标对讲机未应答。

通过菜单启动时，对讲机返回用户别名或 ID 屏幕。

如果通过可预设按钮启动，对讲机将返回主屏幕。

远程监听

使用远程监听功能来打开目标对讲机上的麦克风（仅用户别名或 ID）。绿色 LED 指示灯将在目标用户上闪烁一次。您可以使用该功能远程监听目标对讲机四周的任何声音活动。

您的对讲机必须进行预设才允许您使用该功能。













开始远程监听



说明：

当预设的持续时间结束时或者尝试启动传输、更改信道或关闭对讲机时，远程监听将自动停止。

1 访问远程监听功能。

对讲机控制	步骤
预设的远程监听按钮	<p>a 按预设的远程监听按钮。</p> <p>b 按  或  显示所需用户别名或 ID，然后按  进行选择。</p>
菜单	<p>a 按  访问菜单。</p> <p>b 按  或  显示通讯录，然后按  进行选择。</p> <p>c 按  或  显示所需用户别名或 ID，然后按  进行选择。</p> <p>d 按  或  显示手动拨号，然后按  进行选择。</p>

对讲机控制	步骤
	<p>e 按  或  显示远程监听，然后按  进行选择。</p>

第一行文字显示远程监听。第二行文字显示目标对讲机别名，指示正在处理该请求。LED 绿灯闪烁。

2 等待确认。

如果成功，对讲机会发出一声确定提示音，屏幕会短暂显示远程监听成功。您的对讲机开始播放来自被监听对讲机的声音，直到预设的持续时间结束后才停止，且屏幕会显示远程监听，接着显示目标对讲机别名。时间结束后，对讲机发出一声提示音，且 LED 指示灯熄灭。

如果不成功，对讲机发出一声否定提示音，且屏幕显示远程监听失败。

扫描

此功能允许对讲机监听并加入预设扫描列表中所定义的通话组的呼叫。启用扫描时，扫描图标出现在状态栏中，且 LED 在待机时黄灯闪烁。

开始和停止扫描









说明：

此过程将为所有具备与您当前所选区域相同网络 ID 的 **Connect Plus** 区域打开或关闭扫描功能。值得注意的是，即使通过此过程已打开扫描功能，您扫描列表中的部分（或所有）组可能仍然禁用扫描。有关详细信息，请参阅[编辑扫描列表 \(第 206 页\)](#)。

您可以通过按预设的**扫描**按钮或遵循如下所述的步骤开始和停止扫描。

- 1 按  访问菜单。

- 2 按  或  显示扫描，然后按  进行选择。

3 按  或  显示打开或关闭，然后按  进行选择。

- 扫描启用后，屏幕会显示扫描开。
- 如果启用扫描，“扫描”菜单将显示关闭。
- 扫描禁用后，屏幕会显示扫描关。
- 如果禁用扫描，“扫描”菜单将显示打开。

在扫描期间响应发射信号

扫描时，您的对讲机停在检测到活动的通话组。在控制信道上处于待机状态时，对讲机将持续监听是否存在扫描列表中的任何成员。

1 请握住对讲机，并与嘴保持 1 到 2 英寸（2.5 到 5.0 厘米）的距离。

2 在闲置时间内，按**通话按键**。
LED 绿灯长亮。

3 等通话许可提示音结束后（启用该功能时）对着麦克风清楚地讲话。

4 释放 **PTT** 按钮接听。

如果您在闲置时间内未做出响应，对讲机返回扫描其他通话组。

用户可配置扫描

如果启用“编辑列表”菜单，用户可以从“添加成员”菜单添加和删除扫描成员。扫描列表成员必须是常规组联系人（例如不是多组或站点全呼/网络范围内全呼），它在当前已被分配至 **Connect Plus** 区域的信道选择位置，具有和当前选中的区域相同的网络 ID。通话组别名不能与已包含在当前区域扫描列表中的任何通话组相匹配。

可通过菜单或按预设的**扫描开/关**按钮开启或关闭扫描。

此功能只在对讲机当前未处于呼叫中时工作。如果当前正在接听呼叫，则对讲机无法扫描其他组呼，因此无法得知它们正在进行。呼叫结束后，对讲机返回控制信道时隙，可以扫描处于扫描列表中的组。

开启或关闭扫描







说明：



此过程将为所有具备与您当前所选区域相同网络 ID 的区域打开或关闭扫描功能。值得注意的是，即使通过此过程已打开扫描功能，您扫描列表中的部分（或所有）组可能仍然禁用扫描。有关详细信息，请参阅下一章节。

如果扫描已开启，则扫描图标会出现在屏幕上。扫描开启并且您未参与呼叫时，LED 绿灯+黄灯闪烁。

开启或关闭扫描的过程取决于对讲机的预设情况。如果使用扫描开启/关闭按钮预设，则可以使用该按钮开启或关闭此功能。如果对讲机预设为可通过菜单开启或关闭扫描，则按以下过程操作。

- 1 按  访问菜单。

- 2 按  或  显示扫描，然后按  进行选择。

- 3 按  或  显示打开或关闭，然后按  进行选择。
 - 扫描禁用后，屏幕会暂时显示扫描开。

- 扫描启用后，屏幕会暂时显示扫描关。

编辑扫描列表



说明：

如果扫描列表条目恰好是当前选定组，则无论列表条目当前是否显示复选标记，对讲机都会监听该组的活动。只要对讲机未处于呼叫中，对讲机就会监听其选定组、多组、站点全呼及其默认紧急恢复组（如果已配置）的活动。此操作无法禁用。如果启用“扫描”，对讲机也将在启用“区域扫描列表”的成员上监听活动。

扫描列表确定可以扫描的组。列表在对讲机预设时创建。如果对讲机预设为允许编辑扫描列表，则可以：

- 为列表中的单个组启用/停用扫描。
- 从“添加扫描信道”菜单中添加和删除扫描信道。参见 [通过添加扫描信道菜单添加或删除组 \(第 207 页\)](#)。



**说明:**

扫描列表成员必须是常规组联系人（不是多组或站点全呼/网络范围内全呼），它当前已被分配至

Connect Plus 区域中的信道选择位置，具有和当前选中的区域相同的网络 ID。

通话组别名不能与已包含在当前区域扫描列表中的任何通话组相匹配。

1 按  访问菜单。

2 按  或  显示查看/编辑列表，然后按  进行选择。

3 按  或  显示所需组名称。

如果通话组名称前面显示选中标记，即表示当前已为此通话组启用扫描。

如果通话组名称前面未显示选中标记，即表示当前已为此通话组禁用扫描。

4  以选择所需组。

如果当前为通话组禁用扫描，则屏幕显示启用。

如果当前为通话组启用扫描，则屏幕显示禁用。

5 选择所显示的选项（启用或禁用）并按  进行选择。

根据选择的选项，对讲机短暂显示已启用扫描或已禁用扫描以进行确认。



此时对讲机再次显示区域扫描列表。如果已为通话组启用扫描，通话组名称前面会显示选中标记。如果已为通话组禁用扫描，通话组名称前面显示的选中标记会被删除。



通过添加扫描信道菜单添加或删除组

Connect Plus 对讲机不允许一个区域扫描列表中出现重复的组号码或重复的组别名（或显示为“扫描候选”）。这样在区域扫描列表中添加或删除一个组后，[步骤 6](#) 和 [步骤 7](#) 中所述的“扫描候选”列表有时会变更。

如果对讲机预设为允许编辑扫描列表，则可以使用添加扫描信道菜单向当前选定区域的扫描列表中添加组，或从当前选定区域的扫描列表中删除组。



1 按  访问菜单。

2 按  或  显示“扫描”选项，然后按  进行选择。

- 3 按  或  显示 <添加成员>，然后按  进行选择。

显示屏显示从区域 n 添加成员 (n = 对讲机中具备与当前选定区域相同网络 ID 的首个 **Connect Plus** 的 **Connect Plus** 区域号)。

- 4 执行以下操作之一。
- 如果您要添加至扫描列表中的组分配至该区域的一个信道选择器位置，请转至 **步骤 6**。
 - 如果您要添加至扫描列表中的组分配至不同 **Connect Plus** 区域的一个信道选择位置，请转至 **步骤 5**。

- 5 按  或  以滚动具备与当前选定区域相同网络 ID 的 **Connect Plus** 区域列表。

- 6 定位 **Connect Plus** 区域 (在此区域中，将所需组分配到信道选择位置) 后，按  进行选择。

对讲机显示分配到该区域的信道位置的组列表的第一个条目。在列表中的组被称为“扫描候选”，因为它们可以添加到您当前选定区域的扫描列表中 (或它们已在区域扫描列表中)。

如果该区域没有任何可添加到扫描列表中的组，则对讲机显示无候选。

- 7 按  或  以滚动候选组列表。

如果紧靠组别名前显示加号 (+)，则表示该组目前正在选定区域的扫描列表中。

如果紧靠组别名前未显示加号 (+)，则该组目前不在扫描列表中，但可以添加。

- 8 显示所需组的别名时，按 。

如果该组当前未在当前选定区域的扫描列表中，则会显示添加 (组别名) 信息。

如果该组当前已在当前选定区域的扫描列表中，则会显示删除 (组别名) 信息。

- 9 按  接受所显示的信息 (添加或删除)。

如果从列表中删除一个组，紧靠组别名前将不会再显示加号 (+)，这样您就可以准确知道操作已成功。

如果在列表中添加一个组，组别名前将会显示加号 (+)，这样您就可以准确知道操作已成功。

如果您正在尝试添加一个组，而列表已满，则对讲机会显示列表已满。如果出现这种情况，则需要从扫描列表中先删除一个组，才能再添加一个新组。

10 完成后，根据需要多次按  以返回所需的菜单。

了解扫描操作



说明：

如果对讲机加入来自不同区域的“区域扫描列表”成员的呼叫且呼叫闲置时间计时器在您能够响应前到期，则为了响应，您必须导航到扫描列表成员的区域和信道并启动新呼叫。

在某些情况下，您会错过扫描列表中的组发起的呼叫。如果出于以下某一原因错过呼叫，则不表示对讲机存在问题。这是 **Connect Plus** 的正常扫描操作。

- 扫描功能未开启（在屏幕上检查扫描图标）。
- 扫描列表成员已通过菜单停用（请参阅[编辑扫描列表 \(第 206 页\)](#)）。
- 您正在参与呼叫。
- 扫描的组中成员都未在您所在站点注册（仅限多站点系统）。

扫描对讲

如果对讲机通过在可选通话组扫描列表中扫描呼叫，且在扫描呼叫时按下**通话按键**，则对讲机的操作取决于在对讲机预设过程中扫描对讲是否已启用或禁用。请联系您的经销商或系统管理员了解详情。

扫描对讲已禁用

对讲机放弃扫描呼叫，转而尝试在当前所选信道位置对联系人发射信号。在当前所选联系人的呼叫闲置时间超时后，对讲机返回主信道，并启动扫描闲置时间计时器。对讲机在扫描闲置时间计时器超时后将恢复通话组扫描。

扫描对讲已启用

如果在扫描呼叫的组呼闲置时间内按下**通话按键**，则对讲机尝试向扫描通话组发射信号。



说明：

如果扫描到未分配到当前选定区域信道位置的组呼叫并且错过了呼叫的闲置时间，您需要切换到适当区域，然后选择组的信道位置以回复该组。

编辑通话组的优先级

优先级监听功能允许对讲机在处于某个呼叫中时自动接收具有更高优先级的通话组的传输。当对讲机切换到具有更高优先级的呼叫时，将发出一声提示音。



提供两种通话组优先级：P1 和 P2。P1 的优先级高于 P2。



说明：

如果在 **MOTOTRBO Connect Plus** 选件板 **CPS** 中配置默认紧急恢复组 ID，则提供三种通话组优先级：P0、P1 和 P2。P0 是永久紧急恢复组 ID 和最高优先级。请联系您的经销商或系统管理员了解详情。

- 1 按  访问菜单。
- 2 按  或  显示扫描，然后按  进行选择。
- 3 按  或  显示查看/编辑列表，然后按  进行选择。
- 4 按  或  显示所需的通话组，然后按  进行选择。
- 5 按  或  显示编辑优先级，然后按  进行选择。

- 6 按  或  显示所需优先级，然后按  进行选择。

在返回上一个屏幕前，屏幕会显示确定性的小型通知。“优先级”图标显示在通话组左侧。

通讯录设置



说明：

您可以在 **Connect Plus** 通讯录中添加或编辑用户 ID。删除用户 ID 的操作只能由您的经销商来执行。如果信道上启用了加密功能，您可以在该信道上进行加密语音呼叫。只有当目标对讲机和您的对讲机拥有相同的加密密钥或相同的密钥值和密钥 ID 时，才能对传输进行解密。

联系人列表访问权限取决于区域配置：

- 如果仅在对讲机中配置一个区域，联系人列表直接显示当前选定区域中的列表。
- 如果在对讲机中配置多个区域，“区域联系人”文件夹将显示网络 ID 与当前选定区域相同的所有区域。用户可以访问这些区域中的联系人。

通讯录为对讲机提供“地址簿”功能。每个条目对应于一个用于启动呼叫的别名或 ID。



每个区域提供联系人列表，带有多达 100 个联系人。以下联系人类型可用：

- 单呼
- 组呼
- 多组呼
- 站点全呼语音
- 站点全呼文本
- 调度呼叫

调度呼叫联系人类型用于通过第三方短信服务器给调度员 PC 发送短信。

从通讯录发起单呼

- 1 按  访问菜单。

- 2 按  或  显示通讯录，然后按  进行选择。
条目按字母顺序排列。

- 3 请握住对讲机，并与嘴保持 1 到 2 英寸（2.5 到 5.0 厘米）的距离。

- 4 按 **PTT 键**发起呼叫。

LED 绿灯长亮。

- 5 等通话许可提示音结束后（启用该功能时）对着麦克风清楚地讲话。

- 6 释放 **PTT 按钮**接听。

当目标对讲机发出响应时，LED 绿灯闪烁且屏幕显示发射用户的 ID。

如果在预定时间内无语音活动，则呼叫终止。



您将听见一声短提示音。屏幕显示呼叫结束。

通过别名搜索发起呼叫

您也可以使用别名或字母数字搜索来检索所需用户别名。



本功能仅在通讯录中可用。



- 1 按  访问菜单。

- 2 按  或  显示通讯录，然后按  进行选择。

条目按字母顺序排列。



- 3 键入所需别名的第一个字符，然后按  或  按钮找到所需别名。
- 4 请握住对讲机，并与嘴保持 1 到 2 英寸（2.5 到 5.0 厘米）的距离。
- 5 按 **PTT 键** 发起呼叫。
LED 绿灯长亮。屏幕显示目标别名。
- 6 等通话许可提示音结束后（启用该功能时）对着麦克风清楚地讲话。
- 7 释放 **PTT 按钮** 接听。
当目标对讲机作出响应时，LED 绿灯闪烁。
如果在预定时间内无语音活动，则呼叫终止。
屏幕显示呼叫结束。

- 2 按  或  显示通讯录，然后按  进行选择。

- 3 按  或  显示新联系人，然后按  进行选择。

- 4 使用键盘输入联系人号码，然后按  确认。

- 5 使用键盘输入联系人姓名，然后按  确认。

- 6 如果添加对讲机联系人，按  或  显示所需铃声类型，然后按  进行选择。
对讲机发出一声确定提示音，屏幕显示联系人已保存。

新建联系人

- 1 按  访问菜单。



呼叫提醒设置

此功能允许对讲机用户配置呼叫或短信铃声。



激活和停用呼叫提示的呼叫铃声

您可以选择、打开或关闭接收到的呼叫提醒的铃声。

- 1 按  访问菜单。
- 2 按  或  至实用程序，然后按  进行选择。
- 3 按  或  至对讲机设置，然后按  进行选择。
- 4 按  或  至音调/提示，然后按  进行选择。
- 5 按  或  至呼叫铃声，然后按  进行选择。

- 6 按  或  至呼叫提示，然后按  进行选择。





当前提示音以  表示。



- 7 按  或  至所需提示音，然后按  进行选择。



 所选提示音旁边会出现。



激活和停用单呼呼叫铃声



您可以打开或关闭接收到的单呼的铃声。

- 1 按  访问菜单。
- 2 按  或  显示实用程序，然后按  进行选择。
- 3 按  或  至对讲机设置，然后按  进行选择。

4 按  或  显示提示音/提示，然后按  进行选择。

5 按  或  显示呼叫铃声，然后按  进行选择。



6 按  或  显示单呼，然后按  进行选择。



7 按  启用/禁用单呼的呼叫铃声。
如果启用单呼的呼叫铃声，显示屏在已启用旁边显示 。
禁用单呼的呼叫铃声时，不会显示 .



激活和停用短信呼叫铃声



您可以打开或关闭接收到的短信的铃声。





1 按  访问菜单。





2 按  或  显示实用程序，然后按  进行选择。

3 按  或  至对讲机设置，然后按  进行选择。

4 按  或  显示提示音/提示，然后按  进行选择。

5 按  或  显示呼叫铃声，然后按  进行选择。

6 按  或  显示短信，然后按  进行选择。
当前提示音以  表示。

7 按  或  至所需提示音，然后按  进行选择。
 所选提示音旁边会出现。

选择铃声提示类型



说明:

预设的**铃声提示类型**按钮由您的经销商或系统管理员分配。咨询经销商或系统管理员以确定对讲机的预设情况。

您可以将对讲机呼叫预设为预定的振动呼叫。如果“全部音调”状态为已禁用，则对讲机将显示“全部音调静音”图标。如果“全部音调”状态为已启用，则将显示相关铃声提示类型。

如果铃声为瞬间铃声类型，则对讲机会振动一次。如果铃音为重复铃音类型，则对讲机会重复振动。设置为“响铃并振动”时，如果有任何呼入的对讲机事务（例如呼叫提醒或信息），对讲机将发出特定的铃音。该铃音听起来像确定提示音或未接听呼叫。

渐强警报音

您可将对讲机设置为当对讲机呼叫尚未回复时，不断提醒您。这由警报音量随时间自动增强来实现。此功能称为渐强提示音。

通话记录

您的对讲机将记录所有近期的已拨呼叫、已接来电和未接单呼。使用通话记录功能查看和管理近期的呼叫。



您可以在各呼叫列表中执行以下任务：



- 删除
- 查看详情

查看最近呼叫

呼叫列表分为未接呼叫、已接呼叫和已拨呼叫。

1 按  访问菜单。

2 按  或  显示通话记录，然后按  进行选择。

- 按  或  显示首选列表，然后按  进行选择。



屏幕在列表顶部显示最近期的条目。



- 按  或  查看列表。

按**通话按键**以使用当前所选别名或 ID 发起单呼。



删除呼叫列表中的呼叫



- 按  访问菜单。
-

- 按  或  显示通话记录，然后按  进行选择。
-





- 按  或  显示所需的列表，然后按  进行选择。

当您选择一个呼叫列表但其中没有条目时，屏幕会显示列表已空，此时如果键盘提示音是打开的，就会响起一声低音调提示音。

- 按  或  显示所需别名或 ID，然后按  进行选择。
-



- 按  或  显示删除，然后按  进行选择。
-



- 执行以下操作之一：

- 按  选择是以删除该条目。屏幕显示条目已删除。
 - 按  或  显示否，然后按  按钮返回前一屏幕。
-



查看呼叫列表中的详情

- 按  访问菜单。
-

- 按  或  显示通话记录，然后按  进行选择。
-

3 按  或  显示所需的列表，然后按  进行选择。

4 按  或  显示所需别名或 ID，然后按  进行选择。

5 按  或  显示查看详情，然后按  进行选择。

显示屏显示呼叫列表的详情。

- 黄色 LED 指示灯闪烁。
- 显示屏显示列出呼叫提示以及主叫对讲机别名或 ID 的通知列表。

您可以通过执行以下操作之一响应呼叫提示，具体取决于经销商或系统管理员的配置：

- 按 **PTT** 按钮并通过单呼直接回复呼叫方。
- 按 **PTT** 按钮继续进行正常的通话组通信。
“呼叫提示”被移至“呼叫记录”菜单的“未接来电”选项。您可以从“未接来电记录”响应呼叫方。

有关详细信息，请参阅[通知列表 \(第 149 页\)](#)和[呼叫记录功能 \(第 99 页\)](#)。

呼叫提醒操作

呼叫提醒使您可以提示一个具体的对讲机用户在可能的时间回呼您。

此功能可从菜单使用通讯录、手动拨号或预设的单键接入**单键接入**按钮来使用。

对呼叫提示做出响应



按照步骤在对讲机上对呼叫提示做出响应。

当您接收呼叫提示时：

- 将发出一声重复音。







从通讯录列表发起呼叫提醒



1 按  访问菜单。

2 按  或  显示通讯录，然后按  进行选择。

3 使用如下所述的步骤之一选择所需用户别名或 ID：

- 直接选择用户别名

- 按  或  显示所需用户别名，然后按  进行选择。
- 使用手动拨号菜单
 - 按  或  显示手动拨号，然后按  进行选择。
 - 应该显示“手动拨号”文本输入屏幕。输入用户 ID 并按  。

4 按  或  显示呼叫提示，然后按  进行选择。

屏幕显示呼叫提示：<用户别名或 ID>呼叫提示和用户别名或 ID，表示已经发送呼叫提示。

当对讲机发送呼叫提醒时，绿色 LED 长亮。

如果接收到呼叫提示确认，屏幕显示呼叫提示成功。

如果没有接收到呼叫提示确认，屏幕显示呼叫提示失败。

使用单键接入按钮发出呼叫提醒

按下预设的**单键接入按钮**，向预定义的别名发出呼叫提示。

屏幕显示呼叫提醒和用户别名或 ID，表示已经发送呼叫提醒。

当对讲机发送呼叫提醒时，LED 绿灯长亮。

如果接收到呼叫提示确认，屏幕显示呼叫提示成功。

如果没有接收到呼叫提示确认，屏幕显示呼叫提示失败。

静音模式

静音模式将为用户提供静音对讲机所有音频指示器的选项。

启用静音模式功能后，所有音频指示器都将静音，优先级更高的功能除外（如紧急呼叫操作）。

退出静音模式后，对讲机将恢复播放正在进行的提示音并恢复音频传输。



说明：

这是一项可购买功能。请联系您的经销商或系统管理人员了解详情。

打开静音模式

按照以下步骤打开静音模式。

使用预设的**静音模式**按钮访问此功能。

启用静音模式时，将发生以下情况：



- 发出一声确定提示音。
- 显示屏将显示静音模式开。
- 红色 LED 灯开始闪烁，直至退出静音模式。
- 显示屏主屏幕上显示**静音模式**图标。
- 对讲机处于静音状态。
- 静音模式计时器开始倒数配置的持续时间。



设置静音模式计时器



可通过设置静音模式计时器在预配置的时间内启用静音模式功能。该计时器持续时间在对讲机菜单中配置，可设范围介于 0.5 至 6 小时。计时器到时后将退出静音模式。



如果计时器停留在 0 处，则对讲机将在无限期的时间段内保持静音模式，直至按预设的**静音模式**按钮。

- 1 按  访问菜单。

- 2 按  或  显示设置。按  进行选择。

- 3 按  或  显示对讲机设置。按  进行选择。

- 4 按  或  显示静音计时器。按  进行选择。

- 5 按  或  编辑每个数位的数值，然后按下 。

退出静音模式

静音计时器到时后，此功能会自动退出。

执行以下任一操作手动退出静音模式：

- 按预设的**静音模式**按钮。
- 按任何条目上的 **PTT** 按钮。

禁用静音模式时，将发生以下情况：

- 发出一声否定提示音。
- 显示屏将显示静音模式关。

- 闪烁的红色 LED 指示灯关闭。
- **静音模式**图标将从主屏幕上消失。
- 您的对讲机将取消静音并恢复扬声器状态。
- 如果计时器未到时，则静音模式计时器将被暂停。



说明：

如果用户传输语音或切换至未预设的信道，则将退出静音模式。

紧急操作



说明：

如果对讲机预设为“静音”或“带语音的静音”紧急呼叫发起，大多数情况下它都会在紧急呼叫或紧急提示结束后自动退出静音操作。此规则的例外情况是紧急呼叫模式配置为“紧急提示”并且紧急类型配置为“静音”。如果对讲机按上述方法预设，静音操作将持续到按**通话按键**或配置为“紧急呼叫关闭”的按钮取消操作。

在 **Connect Plus** 自动降级模式下操作时，不支持紧急语音呼叫和紧急报警。有关详细信息，请参阅 [自动降级 \(第 200 页\)](#)。

紧急提示用于表示紧急状况。您可以在任何时候在任何屏幕上，甚至在当前信道上有活动的情况下，发起紧急呼叫。按**紧急呼叫**按钮启动预设的紧急呼叫模式。预设的紧急呼叫模

式还可通过触发可选的倒地功能启动。可在对讲机上禁用紧急呼叫功能。

您的经销商可以设置预设**紧急呼叫**按钮的按下持续时间（除了长按，长按的持续时间与所有其他按钮类似）：

短按

0.05 秒至 0.75 秒之间。

长按

1.00 秒到 3.75 秒之间。

紧急呼叫按钮设有紧急呼叫开/关功能。有关**紧急呼叫**按钮所设置的操作功能，请联系您的经销商。

- 如果短按**紧急呼叫**按钮被设置为开启紧急呼叫模式，则长按**紧急呼叫**按钮被设置为退出紧急呼叫模式。
- 如果长按**紧急呼叫**按钮被设置为开启紧急呼叫模式，则短按**紧急呼叫**按钮被设置为退出紧急呼叫模式。

对讲机选定到 **Connect Plus** 区域时，它支持 3 种紧急呼叫模式：

紧急呼叫

您必须按**通话按键**在指定的紧急时隙通话。

带语音跟随的紧急呼叫

第一次在指定的紧急时隙传输时，麦克风会自动取消静音，无需按**通话按键**即可通话。麦克风将保持该状态，持续对讲机预设的时间。相同紧急呼叫中的后续传输必须按**通话按键**。

紧急提示

紧急提示不是语音呼叫。它是紧急通知，将发送给配置为接收这些提示的对讲机。对讲机会使用当前注册站点的控制信道发送紧急提示。紧急提示会由 **Connect Plus** 网络中预设为接收这些提示的对讲机接收（无论其注册的网络站点情况如何）。

每个区域只能为紧急按钮分配一种紧急呼叫模式。此外，紧急呼叫模式有以下类型：

常规

对讲机发起紧急呼叫并显示语音和/或视觉提示。

静音

对讲机发起紧急呼叫，但不显示任何语音或视觉提示。对讲机将抑制所有紧急的语音或视觉提示，直到按**通话按键**开始语音传输。

带语音的静音

与静音操作相同，不同之处是对讲机还将为某些语音传输取消静音。

接收呼入紧急呼叫

对讲机可预设为发出提示音并显示呼入紧急呼叫相关信息。如果这样进行预设，接收到呼入紧急呼叫时，屏幕会显示带紧急图标的“紧急呼叫详情”屏幕、请求紧急呼叫的对讲机的别名或 ID、用于紧急呼叫的组联系人以及一行其他信息。附加信息是包含通话组联系人的区域的名称。

目前，对讲机仅显示最近解码的紧急呼叫。如果在清除之前的紧急呼叫前接收到新的紧急呼叫，新的紧急呼叫的详情将替代之前的紧急呼叫的详情。

根据对讲机的预设方式，“紧急呼叫详情”屏幕（或“警报列表”屏幕）将始终显示在对讲机显示屏上，即使紧急呼叫结束也是如此。您可以将紧急呼叫详情保存在警报列表中，或者，您可以根据以下章节所述删除紧急呼叫详情。

将紧急呼叫详情保存在警报列表中

将紧急呼叫详情保存到警报列表后，您可以稍后再次查看详细信息，只需从主菜单中选择“警报列表”即可。

- 1 显示“紧急呼叫详情”（或“警报列表”）屏幕时，请按 。

此时将显示**退出警报列表**屏幕。

- 2 执行下列其中一项操作：

- 选择是并按  将紧急呼叫详情保存至警报列表中，并退出“紧急呼叫详情”（或“警报列表”）屏幕。

- 选择否并按  返回“紧急呼叫详情”（或“警报列表”）屏幕。

删除紧急呼叫详情

- 1 显示“紧急呼叫详情”屏幕时，请按 。
此时显示**删除**屏幕。

- 2 执行下列其中一项操作：

- 选择是并按  删除紧急呼叫详情。
- 选择否并按  返回紧急呼叫详情屏幕。

回复紧急呼叫



说明：

如果未在分配的紧急呼叫闲置时间内回复紧急呼叫，则紧急呼叫将终止。如果要在紧急呼叫闲置超时后与通话组对话，您必须先选择分配给通话组的信道位置（如果尚未选择）。然后，按**通话按键**为通话组发起非紧急呼叫。

- 1 当接收到紧急呼叫时，按任意按钮停止所有已接收到紧急呼叫的提示。

- 2 按**通话按键**可对紧急呼叫组发起语音传输。
监听此通话组的所有对讲机都将收听您的传输。

- 3 等通话许可提示音结束后（启用该功能时）对着麦克风清楚地讲话。
LED 绿灯亮起。

- 4 释放 **PTT** 按钮接听。

当紧急呼叫发起对讲机回复时，LED 绿灯闪烁。您将在屏幕上看见组呼图标、通话组 ID 以及发射对讲机 ID。

回复紧急提示



说明：

用于紧急报警的组联系人不应用于语音通信。这将阻止其他对讲机在同一个通话组中发送和接收紧急报警。

对讲机的紧急报警表示用户处于紧急情况。您对警报的回复方法包括向声明紧急的对讲机发起单呼、向指定通话组发起

组呼、给对讲机发送呼叫提示、发起对讲机的远程监听等。正确的回复应根据所在的组织和所处的具体情况确定。

忽略紧急恢复呼叫

此增强功能旨在为对讲机提供一个可忽略正在进行的紧急恢复呼叫的选项。

要启用“忽略紧急恢复呼叫”，必须在 **Connect Plus** 客户编程软件 (CPCPS) 中配置对讲机。

此功能启用后，对讲机不显示紧急呼叫指示且不在默认紧急恢复组 ID 上接收音频。

请联系您的经销商或系统管理员了解详情。

发起紧急呼叫



说明:

如果对讲机设置为静音，它在紧急呼叫模式期间不会显示任何声音或可视指示，直到按**通话按键**发起语音传输。

如果对讲机设置为带语音的静音，则对讲机处于紧急呼叫模式下时不会显示任何声音或可视指示。但是对讲机会为回复紧急呼叫的对讲机传输取消静音。紧急指示只会在按**通话按键**从对讲机发起语音传输时出现一次。

对于“静音”和“带语音的静音”操作，对讲机都将在紧急呼叫结束后自动退出静音操作。

- 1 按预设的**紧急呼叫**按钮。
- 2 按**通话按键**可对紧急呼叫组发起语音传输。

松开**通话按键**时，紧急呼叫会持续分配给紧急呼叫闲置的时间。

如果在此期间按**通话按键**，紧急呼叫将继续。

发起带语音跟随的紧急呼叫

对讲机必须为此操作类型进行预设。

启用此操作时，按预设的**紧急呼叫**按钮并且对讲机接收时隙分配，无需按**通话**按钮，麦克风就会自动激活。这种激活的麦克风状态又称为“紧急麦克风”。“紧急麦克风”适用于紧急呼叫期间从对讲机发出的第一次语音传输。相同紧急呼叫中的后续传输必须按**通话**按钮。

- 1 按预设的**紧急呼叫**按钮。
- 2 麦克风将保持“紧急麦克风”状态，保持时长在对讲机的 **Codeplug** 预设时指定。
在此期间，LED 绿灯亮起。
- 3 按住**通话**按钮进行比预设期间更长时间的通话。

发起紧急提示



说明：

如果对讲机预设为“静音”或“带语音的静音”，则对讲机在发送紧急报警时不会提供任何声音或视觉指示。如果预设为“静音”，静音操作将一直持续，直到按 **PTT** 或配置为“紧急呼叫关”的按钮。如果预设为“带语音的静音”，对讲机会在站点控制器广播紧急报警时自动取消静音操作。

按橙色的**紧急呼叫**按钮。

将紧急报警传输到站点控制器时，对讲机显示屏会显示紧急呼叫图标、用于紧急报警的组联系人以及发射警报。

紧急报警发送成功并且正在广播以便其他对讲机收听后，将发出确定提示音并且对讲机显示已发警报。如果紧急提示失败，会发出一声否定提示音，且对讲机显示警报失败。

退出紧急呼叫模式



说明：

如果紧急呼叫由于紧急呼叫闲置时间超时结束，但是紧急条件未结束，可按**紧急呼叫**按钮重新启动流程。

如果您通过按预设的**紧急呼叫**按钮发起紧急报警，对讲机在接收到来自 **Connect Plus** 系统的回复后将自动退出紧急呼叫模式。

如果按预设的**紧急呼叫**按钮发起紧急呼叫，对讲机将在信道可用时自动获得分配。对讲机已经发送表示紧急的消息后，无法取消紧急呼叫。但是，如果意外按下按钮或紧急情况不再存在，您可通过指定信道说出此情况。松开**通话**按钮时，紧急呼叫将在紧急呼叫闲置时间超时时终止。

如果对讲机配置为紧急语音，可使用“紧急麦克风”期间解释错误，然后按下并松开**通话按键**终止传输。紧急呼叫会在紧急呼叫闲置超时后终止。

短信发送

您的对讲机可以接收数据，例如来自另一对讲机或短信应用程序的短信。

提供两种类型的短信，即数字车载台对讲机 (DMR) 短信和普通短信。一条 DMR 短信的最大长度为 **23** 个字符。一条普通短信的最大长度为 **280** 个字符，包括主题行。仅当从电子邮件应用程序收到消息时，主题行才会出现。



说明：







最大字符长度仅适用于具有最新软件和硬件的型号。对于具有较旧软件和硬件的对讲机型号，一条普通短信的最大长度为 **140** 个字符。请联系您的经销商或系统管理员了解详情。

发送预制短信

通过经销商预编程，您的对讲机最多可支持 **10** 条预制短信。

当预定义了预制短信时，您可以在发送每个短信之前对其进行编辑。

如果您正在发送短信，请执行以下操作来选择收件人：

- 按  或  显示所需别名，然后按  进行选择。
- 按  或  显示手动拨号，然后按  进行选择。屏幕第一行显示号码：。屏幕第二行显示闪烁的光标。输入用户别名或 ID，然后按  。

屏幕显示正在发送信息，确认短信正在发送。

如果短信发送成功，对讲机会发出一声提示音并且屏幕显示消息已发送。

如果短信无法发送，对讲机会发出一声低音调提示音并且屏幕显示消息发送失败。

如果短信发送失败，对讲机会返回重发选项屏幕（请参阅[管理发送失败的短信 \(第 228 页\)](#)）。

使用单键接入按钮发送预制短信

您可以使用经销商预设的可预设按钮发送预制短信。

按预设的**单键接入按钮**向预定义别名发送“预制短信”。

屏幕显示正在发送信息，确认短信正在发送。

如果短信发送成功，对讲机会发出一声提示音并且显示屏显示消息已发送。

如果短信无法发送，对讲机会发出一声低音提示音并且显示屏显示消息发送失败。

如果短信发送失败，对讲机会返回重发选项屏幕（请参阅[管理发送失败的短信 \(第 228 页\)](#)）。

访问草稿箱文件夹

“草稿箱”文件夹最多可存储十 (10) 条最近保存的短信。当此文件夹已满后，下一条保存的短信会自动替换此文件夹中最早的短信。



说明：



您可以在发送保存的短信之前对其进行编辑。只有配备键盘麦克风，该功能才可用（请参阅[编辑和发送已保存的短信 \(第 227 页\)](#)）。在任何时候长按  都可以返回主屏幕。

查看已保存的短信

1 访问短信功能。



对讲机控件	步骤
预设短信按钮	按预设的 短信按钮 。
菜单	<p>a 按  访问菜单。</p> <p>b 按  或  显示消息，然后按  进行选择。</p>

2 按 或 显示草稿箱，然后按 进行选择。

- 3 按  或  显示所需的消息，然后按  进行选择。





编辑和发送已保存的短信

- 1 查看短信时，再次按  。

- 2 按  或  显示编辑，然后按  进行选择。







此时将出现闪烁光标。

- 3 用键盘输入信息。

按  向左移动一个空格。按  或  键向右移动一个空格。按  键删除任何无用的字符。长按  更改文本输入方法。

- 4 写完信息后按  。

- 5 按照下面的方法选择收信人：

- 按  或  显示所需别名，然后按  进行选择。
- 按  或  显示手动拨号，然后按  进行选择。屏幕第一行显示号码：。屏幕第二行显示闪烁的光标。输入用户别名或 ID，然后按  。

屏幕显示正在发送信息，确认短信正在发送。



如果短信发送成功，对讲机会发出一声提示音并且屏幕显示消息已发送。



如果短信无法发送，对讲机会发出一声低音调提示音并且屏幕显示消息发送失败。



如果短信无法发送，它被移至“已发信息”文件夹中并标记发送失败图标。



从“草稿箱”中删除已保存的短信

- 1 访问短信功能。

对讲机控件	步骤
预设短信按钮	按预设的短信按钮。
菜单	<p>a 按  访问菜单。</p> <p>b 按  或  显示消息，然后按  进行选择。</p>

2 按  或  显示草稿箱，然后按  进行选择。

3 按  或  显示所需的消息，然后按  进行选择。

4 按  或  显示删除，然后按  以删除短信。

- 快进
- 编辑

重发短信



按  将同一短信重发给同一用户/通话组别名或 ID。

如果短信发送成功，发出一声提示音，且屏幕显示确定性的小型通知。

如果短信无法发送，屏幕显示否定性的小型通知。

转发短信

选择转发将短信发送给另一用户/通话组别名或 ID。

1 按  或  显示转发，然后按  进行选择。

管理发送失败的短信

在重发选项屏幕中，您可以选择下列一个选项：

- 重发

- 2 要选择收信人，请按  或  显示所需别名或 ID，然后按  进行选择。

屏幕显示正在发送信息，确认短信正在发送。

如果短信发送成功，对讲机会发出一声提示音并且屏幕显示消息已发送。

如果短信无法发送，对讲机会发出一声低音调提示音并且屏幕显示消息发送失败。

管理已发送短信

将短信发送给另一对讲机后，它就会保存到“已发信息”中。始终将最近发送的短信添加到“已发信息”列表的顶部。

已发信息文件夹最多可存储 30 条最近发送的短信。当此文件夹已满后，下一条已发送的短信会自动替换此文件夹中最早的短信。









说明：



在任何时候长按  都可以返回主屏幕。

查看已发送短信

- 1 访问短信功能。

对讲机控件	步骤
预设短信按钮	按预设的短信按钮。
菜单	<ol style="list-style-type: none"> a 按  访问菜单。 b 按  或  显示消息，然后按  进行选择。

- 2 按  或  显示已发送项目，然后按  进行选择。

- 3 按  或  显示所需信息，然后按  进行选择。

屏幕右上角的图标表示短信的状态（请参阅 [已发信息图标](#) (第 185 页)）。

发送已发送的短信

当查看已发送短信时，您可以选择下列一个选项：

- 重发

- 前进
- 编辑
- 删除

1 查看短信时，再次按 。

2  或  以显示以下选项之一，然后按  进行选择。

选项	步骤
前进	选择转发将所选短信发送至另一个用户/组别名或 ID（请参阅 转发短信 (第 228 页) ）。
删除	选择删除删除短信。
重发	<p>选择重发将所选短信重发给同一用户/通话组别名或 ID。</p> <p>屏幕显示正在发送信息，确认正在将相同的短信发送至相同的目标对讲机。</p> <p>如果短信发送成功，对讲机会发出一声提示音并且屏幕显示消息已发送。</p>

选项	步骤
	<p>如果短信无法发送，对讲机会发出一声低音调提示音并且屏幕显示消息发送失败。</p> <p>如果短信发送失败，对讲机将返回重发选项屏幕。按  将同一短信重新发送给同一用户/通话组别名或 ID。</p>



如果您在发送短信时退出短信发送屏幕，则对讲机将在“已发信息”文件夹里对短信状态进行更新，而不显示任何音频或视觉指示。



如果“已发信息”文件夹里的短信状态在更新之前，对讲机模式发生改变或断电，则对讲机将无法完成正在进行的短信处理，并自动将其标记为**发送失败**图标。

对讲机最多可以同时处理五条短信。在此阶段，对讲机不能发送新的短信，并自动将其标记为**发送失败**图标。



在“已发信息”里删除所有已发送短信

1 访问**短信**功能。



对讲机控件	步骤
预设短信按钮	按预设的短信按钮。
菜单	<p>a 按  访问菜单。</p> <p>b 按  或  显示消息，然后按  进行选择。</p>



- 按  或  显示已发送项目，然后按  进行选择。

当您选择已发信息但其中没有短信时，屏幕会显示列表已空，此时如果键盘提示音是打开的，就会响起一声低音调提示音。

- 按  或  显示全部删除，然后按  进行选择。

- 选择以下选项之一。

- 按  或  显示是，然后按  进行选择。屏幕显示确定性的小型通知。

- 按  或  显示否，然后按  以返回前一屏幕。



接收短信

当您的对讲机接收到短信时，屏幕显示包含发送者别名或 ID 的通知列表以及短信图标。

当接收短信时，您可以选择以下选项：

- 读取
- 稍后阅读
- 删除

阅读短信

- 按  或  显示阅读？，然后按  进行选择。

收件箱中的所选短信打开。

- 执行以下操作之一：

- 按  返回收件箱。

- 再按一次  回复、转发或删除短信。

管理收到的短信

使用收件箱管理短信。收件箱可以存储最多 30 条短信。

按照最近接收到的顺序来对收件箱中的短信进行排列。

对讲机支持以下短信选项：

- 回复（通过预制短信）
- 前进
- 删除
- 全部删除







说明：



如果信道类型不匹配，则只能转发、删除或全部删除收到的短信。

在任何时候长按  都可以返回主屏幕。

查看收件箱中的短信



- 1 按  访问菜单。

- 2 按  或  显示消息，然后按  进行选择。

- 3 按  或  显示收件箱，然后按  进行选择。





- 4 按  或  以查看信息。



- 5 执行以下操作之一：



- 按  选择当前信息，然后再次按  可回复、转发或删除该信息。
- 长按  返回主屏幕。

回复收件箱中的短信

- 1 访问短信功能。

对讲机控件	步骤
预设短信按钮	按预设的 短信 按钮。
菜单	<p>a 按  访问菜单。</p> <p>b 按  或  显示消息，然后按  进行选择。</p>

2 按  或  显示收件箱，然后按  进行选择。

3 按  或  显示所需的消息，然后按  进行选择。

4 再次按  进入子菜单。

5 使用您的键盘编写/编辑您的信息。

6 写完信息后按  。

屏幕显示正在发送信息，确认短信正在发送。



如果短信发送成功，对讲机会发出一声提示音并且屏幕显示消息已发送。



如果短信无法发送，对讲机会发出一声低音调提示音并且屏幕显示消息发送失败。



如果短信发送失败，则对讲机会返回到重发选项屏幕（请参阅[管理发送失败的短信](#)（第 228 页））。

删除收件箱中的短信



1 访问短信功能。



对讲机控件	步骤
预设短信按钮	按预设的 短信 按钮。
菜单	<p>a 按  访问菜单。</p> <p>b 按  或  显示消息，然后按  进行选择。</p>

2 按  或  显示收件箱，然后按  进行选择。

3 按  或  显示所需的消息，然后按  进行选择。

4 再次按  进入子菜单。

5 按  或  显示删除，然后按  进行选择。

6 按  或  显示是，然后按  进行选择。
显示屏将显示信息已删除，屏幕返回到收件箱。

删除收件箱中的所有短信

1 访问短信功能。

对讲机控件 步骤



预设短信按钮	按预设的短信按钮。
--------	-----------

对讲机控件 步骤

菜单



a 按  访问菜单。

b 按  或  显示消息，
然后按  进行选择。

2 按  或  显示收件箱，然后按  进行选择。

当您选择收件箱但其中没有短信时，屏幕会显示列表已空，此时如果键盘提示音是打开的，就会响起一声低音调提示音（请参阅[打开或关闭键盘音 \(第 161 页\)](#)）。

3 按  或  显示全部删除，然后按  进行选择。

4 按  或  显示是，然后按  进行选择。
屏幕显示收件箱已清空。

加密

假如启用此功能，有利于防止信道上的其他用户利用软件加密的方法未经授权而进行窃听。发射的信令和用户识别部分未加密。

对讲机必须在当前信道选择器位置启用加密功能才能发送加密发射信号，虽然这不是接收发射的必需要求。同时在启用了加密功能的信道选择器位置上，对讲机仍然可以接收到清晰的（解密）发射信号。

您的对讲机支持增强型加密。

要对加密呼叫发射信号进行解密，您的对讲机必须进行预设，以便与发射对讲机拥有相同的密钥值和密钥 ID（对于增强型加密）。

如果您的对讲机收到具有不同密钥值和密钥 ID 的加密呼叫，您将什么也听不到（增强型加密）。

如果对讲机已分配了加密类型，除非对讲机正在发送或接收紧急呼叫或者警报，否则主屏幕都会显示安全或不安全图标。

在对讲机处于发送状态时，LED 绿灯长亮；而当对讲机正在接收启用加密功能的发射信号时，绿色指示灯会急速闪烁。

您可以通过执行以下操作之一访问此功能：

- 按预设的**加密**键打开或关闭加密。
- 使用如下所述步骤中描述的对讲机菜单。



说明：

某些对讲机型号可能不提供加密功能。请联系您的经销商或系统管理员了解详情。

- 1 按  访问菜单。

- 2 按  或  显示实用程序，然后按  进行选择。

- 3 按  或  显示对讲机设置或按  或  显示 Connect Plus，然后按  进行选择。

- 4 按  或  显示增强型加密。

如果屏幕显示打开，请按  启用加密。对讲机将显示一条消息，要求确认您的选择。

如果屏幕显示关闭，请按  禁用加密。对讲机将显示一条消息，要求确认您的选择。

如果对讲机已分配了加密类型，除非对讲机正在发送或接收紧急提示，否则状态栏中都会显示安全或不安全图标。

发起启用加密（已加密）的呼叫

使用预设的加密按钮或使用菜单打开加密。对讲机必须为当前选定的信道位置启用加密功能以进行加密传输。当前选定信道位置启用加密时，对讲机发起的所有语音传输都将加密。这包括组呼、多组呼、扫描呼叫期间回复、站点全呼、紧急呼叫和单呼。只有接收对讲机具有与您的对讲机相同的密钥值和密钥 ID 时才能解密传输。

Security

您可以启用或禁用系统内的任何对讲机。例如，您可能想禁用一个被偷走的对讲机，防止窃贼使用它，并在追回时启用它。









说明：

执行对讲机遥毙或激活仅限于激活这些功能的对讲机。请联系您的经销商或系统管理员了解详情。











对讲机遥毙

1 通过执行以下操作之一可访问该功能：

对讲机控件	步骤
对讲机遥毙按钮	<p>a 按预设的对讲机遥毙按钮。</p> <p>b 按  或  显示所需别名或 ID，然后按  进行选择。</p>
对讲机菜单	<p>a 按  访问菜单。</p> <p>b 按  或  显示通讯录，然后按  进行选择。条目按字母顺序排列。</p> <p>c 使用如下所述的步骤之一选择所需用户别名或 ID：</p> <ul style="list-style-type: none"> 直接选择所需的别名或 ID。

对讲机控
件

步骤

- 按  或  显示所需别名或 ID，然后按  进行选择。
- 使用手动拨号菜单。
 - 按  或  显示手动拨号，然后按  进行选择。
 - 按  或  显示对讲机号，然后按  进行选择。
- 屏幕第一行显示对讲机号：。屏幕第二行显示闪烁的光标。使用键盘输入用户别名或 ID，然后按 。

对讲机控
件

步骤

- d** 按  或  显示对讲机遥毙，然后按  进行选择。

屏幕显示对讲机遥毙：<目标别名或 ID>，且 LED 绿灯闪烁。











2 等待确认。











如果成功，对讲机会发出一声确定提示音，并且屏幕显示对讲机遥毙成功。

如果失败，对讲机会发出一声否定提示音，并且屏幕显示对讲机遥毙失败。

对讲机激活

- 1 通过执行以下操作之一可访问该功能：

对讲机控件	步骤
对讲机激活按钮	<p>a 按预设的对讲机激活按钮。</p> <p>b 按  或  显示所需别名或 ID，然后按  进行选择。</p>
对讲机菜单	<p>a 按  访问菜单。</p> <p>b 按  或  显示通讯录，然后按  进行选择。条目按字母顺序排列。</p> <p>c 使用其中如下所述的步骤之一选择所需用户别名或 ID</p> <ul style="list-style-type: none"> • 直接选择所需的别名或 ID。 • 按  或  显示所需别名或 ID，然后按  进行选择。

对讲机控件	步骤
	<ul style="list-style-type: none"> • 使用手动拨号菜单。 <ul style="list-style-type: none"> • 按  或  显示手动拨号，然后按  进行选择。 • 按  或  显示对讲机号，然后按  进行选择。 • 屏幕第一行显示对讲机号：。屏幕第二行显示闪烁的光标。使用键盘输入用户别名或 ID，然后按  。 d 按  或  显示对讲机激活，然后按  进行选择。

屏幕显示对讲机激活：<用户别名或 ID>，且 LED 绿灯长亮。

2 等待确认。

如果成功，发出一声确定提示音，且屏幕显示对讲机激活成功。

如果失败，对讲机会发出一声否定提示音，并且屏幕显示对讲机激活失败。

蓝牙操作



说明：

如果通过 CPS 禁用，所有蓝牙相关功能都将禁用，并且蓝牙设备数据库将被擦除。

该功能允许您通过无线蓝牙连接将您的对讲机与激活了蓝牙功能的设备（附件）一起使用。您的对讲机支持 **Motorola Solutions** 提供的以及市场上出售 (COTS) 的带蓝牙功能的设备。

蓝牙的有效视线距离是 10 米 (32 英尺)。该距离是指您的对讲机与已启用蓝牙功能设备之间的无障碍距离。

如果您将对讲机放在离激活了蓝牙功能的设备较远的地方，则因为二者之间相隔较远，蓝牙设备可能无法提供较高的工作可靠性。









在信号接收范围的边缘区域，您所听到的语音和提示音可能会变得“含混不清”或“断断续续”。要解决这一问题，只需将

您的对讲机和激活了蓝牙功能的设备彼此靠近一些（使它们在规定的 10 米/32 英尺范围内），以便重新接收能够提供清晰音频的较强信号。您的对讲机的蓝牙功能在 10 米/32 英尺范围内的最大功率为 2.5 mW (4 dBm)。







您的对讲机最多可同时与四个不同类型的蓝牙设备建立蓝牙连接。例如，耳机和一个仅具备 PTT 功能的设备 (POD)。您的对讲机不支持同时与多个同一类型的设备建立蓝牙连接。

要详细了解启用了蓝牙功能的设备的全部功能，请参阅各个设备的用户手册。

打开和关闭蓝牙

- 1 按  访问菜单。
- 2 按  或  显示蓝牙，然后按  进行选择。
- 3 按  或  显示我的状态，然后按  进行选择。
屏幕显示开和关。当前状态通过  指示。

4 执行以下操作之一：



- 按  或  显示开，然后按  进行选择。屏幕显示开且  将出现在所选状态的左侧。
- 按  或  显示关，然后按  进行选择。屏幕显示关且  将出现在所选状态的左侧。



查找和连接到蓝牙设备

在执行查找和连接操作的过程中不要关闭您的蓝牙设备或按 ，否则会导致操作被取消。









1 打开您的蓝牙设备，并将其设置为配对模式。请参阅相应的蓝牙设备用户手册。



2 在对讲机上按  访问菜单。

3 按  或  显示蓝牙，然后按  进行选择。

4 按  或  显示设备，然后按  进行选择。

5 执行以下操作之一：

- 按  或  显示所需的设备，然后按  进行选择。
- 按  或  显示查找设备以查找可用设备。按  或  显示所需的设备，然后按  进行选择。

6 按  或  显示连接，然后按  进行选择。

显示屏显示正在连接到 <设备>。您的蓝牙设备可能需要您执行其他步骤以完成配对过程。请参阅相应的蓝牙设备用户手册。

如果成功，对讲机显示屏会显示<设备> 已连接。一声音响起，已连接的设备旁边将出现 。状态栏中出现“蓝牙已连接”图标。







如果失败，对讲机的显示屏显示连接失败。

从蓝牙设备查找和连接（可发现模式）

请不要在查找和连接操作期间关闭蓝牙或对讲机，因为这会取消操作。

1 打开蓝牙。

请参阅[打开和关闭蓝牙 \(第 239 页\)](#)。













2 按  访问菜单。**3** 按  或  显示蓝牙，然后按  进行选择。**4** 按  或  显示查找我，然后按  进行选择。

现在，在预设的持续时间内，您的对讲机可以被其他支持蓝牙功能的设备找到。这就是“可发现模式”。

5 打开您的蓝牙设备，并将其与您的对讲机配对。

请参阅相应的蓝牙设备用户手册。

断开与蓝牙设备的连接

1 在对讲机上按  访问菜单。**2** 按  或  显示蓝牙，然后按  进行选择。**3** 按  或  显示设备，然后按  进行选择。**4** 按  或  显示所需的设备，然后按  进行选择。**5** 按  或  显示断开，然后按  进行选择。

显示屏显示正在与 <设备> 断开连接。您的蓝牙设备可能需要您执行其他步骤以完成断开过程。请参阅相应的蓝牙设备用户手册。

对讲机显示屏显示 <设备> 已断开连接。对讲机发出一声确定提示音，然后已连接的设备旁边的  消失。状态栏中的蓝牙已连接图标消失。





在对讲机内部扬声器和蓝牙设备之间切换音频路由



您可以在对讲机内部扬声器和启用了蓝牙功能的外部附件之间切换音频路由。

按预设的**蓝牙音频切换**按钮。

- 发出一声提示音，且屏幕显示将音频路由到对讲机。
- 发出一声提示音，且屏幕显示将音频路由到蓝牙。

查看设备详情

- 1 按  访问菜单。
- 2 按  或  显示蓝牙，然后按  进行选择。
- 3 按  或  显示设备，然后按  进行选择。
- 4 按  或  显示所需的设备，然后按  进行选择。

- 5 按  或  显示查看详情，然后按  进行选择。

删除设备名称

您可从蓝牙设备列表中删除已断开连接的设备。

- 1 按  访问菜单。
- 2 按  或  显示蓝牙，然后按  进行选择。
- 3 按  或  显示设备，然后按  进行选择。
- 4 按  或  显示所需的设备，然后按  进行选择。
- 5 按  或  显示删除，然后按  进行选择。
屏幕显示已删除设备。

蓝牙麦克风增益

允许控制已连接的支持蓝牙功能的设备麦克风增益值。

- 1 按  访问菜单。

- 2 按  或  显示蓝牙，然后按  进行选择。

- 3 按  或  显示 BT 麦克风增益，然后按  进行选择。

- 4 按  或  显示蓝牙麦克风增益类型和当前值。

要编辑数值，请按  进行选择。

- 5 按  或  可增大或减小值，然后按  进行选择。

室内定位



说明：

室内定位功能适用于具有最新软件和硬件的型号。请联系您的经销商或系统管理员了解详情。

室内定位用于跟踪对讲机用户的位置。启用室内定位时，对讲机处于受限制可发现模式。专用的信标用于定位对讲机并确定其位置。

打开或关闭室内定位

您可以通过执行以下操作之一打开或关闭室内定位。

- 通过菜单访问此功能。
 - a. 按  访问菜单。
 - b. 按  或  至蓝牙，然后按  进行选择。
 - c. 按  或  至室内定位，然后按  进行选择。
 - d. 按  打开室内定位。

显示屏显示室内定位开。您会听到一声确定提示音。

会发生以下情况之一。

- 如果成功，“室内定位可用”图标出现在主屏幕显示屏上。
- 如果失败，显示屏显示打开失败。您会听到一声否定提示音。

e. 按  关闭室内定位。

显示屏显示室内定位关。您会听到一声确定提示音。

会发生以下情况之一。

- 如果成功，“室内定位可用”图标在主屏幕显示屏上消失。
- 如果失败，显示屏显示关闭失败。您会听到一声否定提示音。

- 使用预设按钮访问此功能。

a. 长按预设的**室内定位**按钮，打开室内定位。

显示屏显示室内定位开。您会听到一声确定提示音。

会发生以下情况之一。

- 如果成功，“室内定位可用”图标出现在主屏幕显示屏上。

- 如果失败，显示屏显示打开失败。如果失败，您将听到一声否定提示音。

b. 按预设的**室内定位**按钮，关闭室内定位。

显示屏显示室内定位关。您会听到一声确定提示音。



会发生以下情况之一。



- 如果成功，“室内定位可用”图标在主屏幕显示屏上消失。
- 如果失败，显示屏显示关闭失败。如果失败，您将听到一声否定提示音。



访问室内定位信标信息

按照步骤访问室内定位信标信息。

- 1 按  访问菜单。

- 2 按  或  至蓝牙，然后按  进行选择。

- 3 按  或  至室内定位，然后按  进行选择。

- 4 按  或  至信标，然后按  进行选择。

屏幕显示信标信息。

通知列表

您的对讲机上有一个通知列表收集了信道上所有的“未读”事件，比如未读的短信、未接呼叫和呼叫提示。

当通知列表中有一个或多个事件时，状态栏中会显示通知图标。

该列表支持最多 40 个未读事件。当该列表已满后，最新的事件会自动替换最早的事件。







说明：



当读取了某个事件后，该事件会从通知列表中移除。

访问通知列表

按照步骤访问通知列表。

- 1 按  访问菜单。

- 2 按  或  显示通知，然后按  进行选择。

- 3 按  或  显示所需的事件，然后按  进行选择。

长按  返回主屏幕。

Wi-Fi 操作

此功能允许您设置和连接至 Wi-Fi 网络。Wi-Fi 支持更新对讲机固件、Codeplug 和资源，例如语言包和语音提示。



说明：

此功能仅适用于 XiR M8668i/CM7668i。

Wi-Fi® 是 Wi-Fi Alliance® 的注册商标。

对讲机支持 WEP/WPA/WPA2-个人和 WPA/WPA2-企业 Wi-Fi 网络。

WEP/WPA/WPA2-个人 Wi-Fi 网络

使用基于预共享密钥（密码）的身份验证。

预共享密钥可使用菜单或 CPS/对讲机管理输入。

WPA/WPA2-企业 Wi-Fi 网络

使用基于证书的身份验证。

对讲机必须预配置有证书。

**说明:**

要连接到 WPA/WPA2-企业 Wi-Fi 网络，请咨询经销商或系统管理员。

预设的**打开或关闭 Wi-Fi** 按钮由您的经销商或系统管理员分配。咨询经销商或系统管理员以确定对讲机的预设情况。

预设的**打开或关闭 Wi-Fi** 按钮的语音提示可以根据用户要求，通过 CPS 自定义。请联系您的经销商或系统管理员了解详情。

**说明:**



您可以使用监控对讲机远程打开或关闭 Wi-Fi（请参阅[使用监控对讲机打开或关闭 Wi-Fi](#)）。请联系您的经销商或系统管理员了解详情。



打开或关闭 Wi-Fi

按照步骤打开或关闭 Wi-Fi。

- 1 按预设的**打开或关闭 Wi-Fi** 按钮。语音提示会发出：打开或关闭 Wi-Fi。

- 2 使用菜单访问此功能。
 - a 按  访问菜单。

b 按  或  显示 Wi-Fi，然后按  进行选择。

c 按  或  显示 Wi-Fi 开和按  进行选择。

d 按  以打开/关闭 Wi-Fi。

如果 Wi-Fi 处于打开状态，屏幕将在已启用旁边显示 。

如果 Wi-Fi 处于关闭状态， 将从已启用旁边消失。



使用指定的对讲机（单独控制）远程打开或关闭 Wi-Fi



进行单独控制（一对一）时，请按照下面的过程操作，远程打开或关闭 Wi-Fi。



**说明:**

具有特定 CPS 设置的对讲机才支持此功能，请联系您的经销商或系统管理员了解更多信息。

- 1 执行以下操作之一：

- 长按可预设按钮。使用键盘输入 ID，并按  进行选择。继续 [步骤 3](#)。
- 按  访问菜单。

2 按  或  显示通讯录和按  进行选择。

3 按  或  至 WiFi 控制，然后按  进行选择。

4 按  或  以选择开或关。

5 按  进行选择。

如果成功，显示屏显示肯定的小型通知。

如果不成功，显示屏显示否定性的小型通知。

使用指定的对讲机（通话组控制）远程打开或关闭 Wi-Fi



进行通话组控制（一对多）时，请按照下面的过程操作，远程打开或关闭 Wi-Fi。







说明：

具有特定 CPS 设置的对讲机才支持此功能，请联系您的经销商或系统管理员了解更多信息。

1 按  访问菜单。

2 按  或  显示通讯录和按  进行选择。

3 按  或  选择所需的用户别名或 ID。

4 按  或  至 WiFi 控制，然后按  进行选择。

5 按  或  以选择开或关。

6 按  进行选择。

如果成功，显示屏显示发送成功。

如果不成功，显示屏显示否定性的小型通知。

连接到网络接入点

当您打开 Wi-Fi 时，对讲机扫描并连接到网络接入点。







说明:



您也可以使用菜单连接到网络接入点。

WPA-企业 Wi-Fi 网络接入点可预配置。咨询经销商或系统管理员以确定对讲机的预设情况。

1 按  访问菜单。

2 按  或  显示 WiFi，然后按  进行选择。



3 按  或  显示网络，然后按  进行选择。

4 按  或  显示一个网络接入点，然后按  进行选择。



说明:

对于 WPA-企业 Wi-Fi，如果未预配置网络接入点，则连接选项不可用。

5 按  或  显示连接，然后按  进行选择。

6 对于 WPA-个人 Wi-Fi，输入密码并按  。

7 对于 WPA-企业 Wi-Fi，密码可使用对讲机管理进行配置。

如果预配置的密码正确，则对讲机会自动连接到选定的网络接入点。

如果预配置的密码不正确，显示屏会显示身份验证失败，并自动返回到上一级菜单。

如果连接成功，对讲机会显示一条通知并将网络接入点保存到配置文件列表中。

如果连接失败，对讲机显示屏会短暂显示故障通知屏幕并自动返回到上一级菜单。

检查 Wi-Fi 连接状态

按照步骤检查 Wi-Fi 连接状态。

按预设的 **Wi-Fi 状态查询** 按钮，使用语音提示了解连接状态。语音提示发出：**Wi-Fi 关闭**、**Wi-Fi 打开但未建立连接**，或 **Wi-Fi 打开并建立连接**。

- 关闭 Wi-Fi 时，显示屏显示 Wi-Fi 关。
- 对讲机连接至网络时，显示屏显示 Wi-Fi 开，已连接。
- Wi-Fi 打开但对讲机未连接至任何网络时，显示屏显示 Wi-Fi 开，连接断开。

Wi-Fi 状态查询结果的语音提示可以根据用户要求，通过 CPS 自定义。请联系您的经销商或系统管理员了解详情。



说明:



预设的 **Wi-Fi 状态查询** 按钮由您的经销商或系统管理员分配。咨询经销商或系统管理员以确定对讲机的预设情况。



刷新网络列表

按照步骤刷新网络列表。

- 通过菜单执行以下操作以刷新网络列表。



a. 按  访问菜单。

b. 按  或  显示 Wi-Fi，然后按  进行选择。

c. 按  或  显示网络，然后按  进行选择。

当您进入“网络”菜单时，对讲机将自动刷新网络列表。

- 如果您已在“网络”菜单中，请执行以下操作以刷新网络列表。

按  或  至刷新，然后按  进行选择。

对讲机将刷新并显示最新的网络列表。

添加网络



说明:

此任务不适用于 WPA-企业 Wi-Fi 网络。

如果首选网络不在可用网络列表中，请执行以下操作以添加网络。

- 1 按  访问菜单。

 - 2 按  或  显示 WiFi，然后按  进行选择。

 - 3 按  或  显示网络，然后按  进行选择。

 - 4 按  或  至添加网络，然后按  进行选择。

 - 5 输入服务集标识符 (SSID)，然后按  。

 - 6 按  或  至打开，然后按  进行选择。

 - 7 输入密码并按  。
- 对讲机将显示确定性的小型通知，指明已成功保存网络。

查看网络接入点的详细信息

您可以查看网络接入点的详细信息。

- 1 按  访问菜单。

 - 2 按  或  显示 WiFi，然后按  进行选择。

 - 3 按  或  显示网络，然后按  进行选择。

 - 4 按  或  显示一个网络接入点，然后按  进行选择。

 - 5 按  或  至查看详情，然后按  进行选择。
-  **说明：**
WPA-个人 Wi-Fi 和 WPA-企业 Wi-Fi 显示网络接入点的不同详细信息。

WPA-个人 Wi-Fi

对于已连接的网络接入点，对讲机显示服务集标识符 (SSID)、安全模式、媒体访问控制 (MAC) 地址和互联网协议 (IP) 地址。

对于未连接的网络接入点，对讲机显示 SSID 和安全模式。

WPA-企业 Wi-Fi

对于已连接的网络接入点，对讲机显示 SSID、安全模式、身份、扩展身份验证协议 (EAP) 方法、阶段 2 身份验证、证书名称、MAC 地址、IP 地址、网关、DNS1 和 DNS2。

对于未连接的网络接入点，对讲机显示 SSID、安全模式、身份、EAP 方法、阶段 2 身份验证和证书名称。

删除网络接入点









说明：



此任务不适用于企业 Wi-Fi 网络。

请执行以下操作以从配置文件列表中删除网络接入点。



- 1 按  访问菜单。

- 2 按  或  显示 WiFi，然后按  进行选择。

- 3 按  或  显示网络，然后按  进行选择。

- 4 按  或  至所选网络接入点，然后按  进行选择。

- 5 按  或  至删除，然后按  进行选择。

- 6 按  或  至是，然后按  进行选择。

对讲机将显示确定性的小型通知，指明已成功删除所选的网络接入点。

实用工具



本章介绍对讲机中可用的实用功能操作。



打开或关闭对讲机提示音/提示

如果需要，您可以启用和禁用所有对讲机提示音和提示（紧急呼入提示音除外）。

按预设的**所有提示音/提示**按钮 打开或关闭全部提示音，或者按照如下所述的步骤通过对讲机菜单来访问此功能。

- 1 按  访问菜单。
- 2 按  或  至实用程序，然后按  进行选择。
- 3 按  或  至对讲机设置，然后按  进行选择。
- 4 按  或  至提示音/提示，然后按  进行选择。



- 5 按  或  显示全部提示音，然后按  进行选择。



- 6 按  启用/禁用全部提示音和提示。
显示屏在已启用旁边显示 。
已启用旁边的  消失。



设置提示音音量偏移度

如果需要，您可以设置提示音音量偏移度。此功能调节音调/提示的音量，允许它比语音音量高一些或低一些。



- 1 按  访问菜单。
- 2 按  或  显示实用程序，然后按  进行选择。
- 3 按  或  至对讲机设置，然后按  进行选择。

4 按  或  显示提示音/提示，然后按  进行选择。

5 按  或  显示音量偏移，然后按  进行选择。

6 按  或  显示所需音量值。
对于每个对应的音量值，对讲机发出反馈提示音。



7 执行以下操作之一：



- 按  保持所需的显示音量值。
 - 按  退出而不更改当前音量偏移设置。
-



打开或关闭通话许可提示音



如果需要，您可启用和禁用通话许可提示音。



1 按  访问菜单。

2 按  或  显示实用程序，然后按  进行选择。

3 按  或  至对讲机设置，然后按  进行选择。

4 按  或  显示提示音/提示，然后按  进行选择。

5 按  或  显示通话许可，然后按  进行选择。

6 按  启用/禁用通话许可提示音。
显示屏在已启用旁边显示 。
已启用旁边的  消失。

打开或关闭开机提示音

如果需要，您可以启用和禁用开机提示音。

- 1 按  访问菜单。

- 2 按  或  显示实用程序，然后按  进行选择。

- 3 按  或  至对讲机设置，然后按  进行选择。

- 4 按  或  显示提示音/提示，然后按  进行选择。

- 5 按  或  显示开机，然后按  进行选择。

- 6 按  以启用/禁用开机提示音。
显示屏在已启用旁边显示 。
已启用旁边的  消失。

设置功率级别

您可以为每个 **Connect Plus** 区域将对讲机功率级别自定义为高或低。

高用于与距离相对较远的对讲机塔站（**Connect Plus** 模式下）进行通信。低用于与较近处的对讲机塔站（**Connect Plus** 模式下）进行通信。

按预设的**功率级别**按钮 在高和低功率之间切换对讲机的发射功率级别。



遵循如下所述的步骤通过对讲机菜单访问此功能。

- 1 按  访问菜单。

- 2 按  或  至实用程序，然后按  进行选择。

- 3 按  或  至对讲机设置，然后按  进行选择。

- 4 按  或  至功率，然后按  进行选择。

5 按  或  至所需的设置，然后按  进行选择。



✓ 出现在所选设置旁边。在任何时候，长按  返回主屏幕。



屏幕将返回上一级菜单。



更改显示模式

您可以根据需要将对讲机显示模式更改为日间显示模式或夜间显示模式。这将影响屏幕的颜色配置。



1 按  访问菜单。

2 按  或  显示实用程序，然后按  进行选择。

3 按  或  至对讲机设置，然后按  进行选择。

4 按  或  显示显示，然后按  进行选择。

屏幕显示日间模式和夜间模式。

5 按  或  显示所需设置，然后按  启用。✓ 出现在所选设置旁边。

调节屏幕亮度



您可以根据需要调节对讲机的屏幕亮度。









说明：



激活“自动亮度”时，无法调节屏幕亮度。

1 按  访问菜单。



2 按  或  显示实用程序，然后按  进行选择。

3 按  或  至对讲机设置，然后按  进行选择。

4 按  或  显示显示，然后按  进行选择。

5 按  或  显示亮度，然后按  进行选择。



屏幕上显示一个进度条。



6 按  降低显示屏亮度或按  提高显示屏亮度。从设置 1 至 8 中选择。按  确认您的输入。



打开或关闭开机界面

如果需要，您可启用和禁用开机界面。

1 按  访问菜单。

2 按  或  显示实用程序，然后按  进行选择。

3 按  或  至对讲机设置，然后按  进行选择。

4 按  或  显示显示，然后按  进行选择。

5 按  或  显示开机界面，然后按  进行选择。

6 按  启用/禁用开机界面。

显示屏在已启用旁边显示 。



已启用旁边的  消失。



语言



您可将对讲机屏幕的显示语言设置为所需语言。

1 按  访问菜单。

2 按  或  显示实用程序，然后按  进行选择。

3 按  或  至对讲机设置，然后按  进行选择。

4 按  或  显示语言，然后按  进行选择。

5 按  或  显示所需语言，然后按  启用。✓ 出现在所选语言旁边。

4 按  或  显示 LED 指示灯，然后按  进行选择。



5 按  启用/禁用 LED 指示灯。
显示屏在已启用旁边显示 ✓。
已启用旁边的 ✓ 消失。

打开或关闭 LED 指示灯

如果需要，您可启用和禁用 LED 指示灯。

1 按  访问菜单。



2 按  或  显示实用程序，然后按  进行选择。



3 按  或  至对讲机设置，然后按  进行选择。



识别线缆类型

您可以选择对讲机使用的线缆类型。

1 按  访问菜单。

2 按  或  显示实用程序，然后按  进行选择。

3 按  或  至对讲机设置，然后按  进行选择。

4 按  或  显示电缆类型，然后按  进行选择。



5 当前线缆类型以  表示。



语音提示

该功能使得对讲机可以通过语音方式指示用户刚刚分配的前区域或信道或者指示所按的可预设按钮。此音频指示器可根据客户需求进行自定义。当用户难以阅读屏幕上显示的内容时，此功能通常非常有用。

1 按  访问菜单。





2 按  或  至实用程序，然后按  进行选择。

3 按  或  至对讲机设置，然后按  进行选择。

4 按  或  显示语音提示，然后按  进行选择。

您也可以使用  或  更改所选选项。



5 执行以下操作之一：



- 按  启用语音提示。显示屏在已启用旁边显示 。
- 按  禁用语音提示。已启用旁边的  消失。



菜单计时器



设置您的对讲机在自动切换至主屏幕前在菜单中所停留的时间。



1 按  访问菜单。



2 按  或  显示实用程序，然后按  进行选择。



3 按  或  至对讲机设置，然后按  进行选择。



4 按  或  显示显示，然后按  进行选择。



5 按  或  显示菜单计时器，然后按  进行选择。

6 按  或  显示所需的设置，然后按  进行选择。

2 按  或  显示实用程序，然后按  进行选择。

3 按  或  至对讲机设置，然后按  进行选择。

4 按  或  显示喇叭/灯，然后按  进行选择。

5 按  启用/禁用喇叭/灯光。
显示屏在已启用旁边显示 。
已启用旁边的  消失。

打开/关闭喇叭/灯

该功能需要由您的经销商通过对讲机的后附件接口来安装。

对讲机可通过喇叭和灯光功能做出呼入电话提示。被激活时，呼入电话触发您的车辆喇叭并开启其灯光。



1 执行以下操作之一：



- 按预设的**喇叭/灯**按钮打开或关闭喇叭和灯功能。跳过以下步骤。
- 按  访问菜单。



设置双用旋钮操作首选项



您的对讲机有一个双用途的**音量/信道旋钮**。停用双用选项后，该旋钮将只作为音量旋钮使用。

1  访问菜单。

2  或  显示实用程序，然后按  进行选择。

3  或  显示对讲机设置，然后按  进行选择。



4  或  显示双用旋钮，然后按  进行选择。



5 显示屏显示仅音量和音量和信道。  或  。
以显示所需的设置，然后按  进行选择。
✓ 出现在所选设置旁边。
屏幕将返回上一级菜单。



数字麦克风 AGC (麦克风 AGC-D)

在数字系统中发射信号时，此功能可以自动控制对讲机的麦克风增益。此功能会抑制高音频或提升低音频以将音频保持在预设的值，从而实现一致的音频水平。

1 按  访问菜单。

2 按  或  显示实用程序，然后按  进行选择。

3 按  或  至对讲机设置，然后按  进行选择。

4 按  或  显示麦克风 AGC-D，然后按  进行选择。

5 执行以下操作之一：

- 按  启用**麦克风 AGC-D**。显示屏在已启用旁边显示 ✓。
 - 按  禁用**麦克风 AGC-D**。✓从已启用旁边消失。
-

智能音频

您的对讲机可以自动调整音量以克服环境中存在的背景噪音（包括所有静态和非静态噪音源）。此功能只对接收的音频有效，不会影响发射的音频。

- 1 按  访问菜单。

对讲机控制	步骤
菜单	<p>a 按  访问菜单。</p> <p>b 按  或  至对讲机设置，然后按  进行选择。</p> <p>c 按  或  至对讲机设置，然后按  进行选择。</p>



对讲机控制





步骤



- d** 按  或  显示智能音频，然后按  进行选择。









说明:

您也可以使用  或  更改所选选项。





- e** 执行以下操作之一：
- 按  启用智能音频。显示屏在已启用旁边显示 。
 - 按  禁用智能音频。已启用旁边的  消失。

- 2 按  或  至实用程序，然后按  进行选择。

3 按  或  至对讲机设置，然后按  进行选择。

4 按  或  显示智能音频，然后按  进行选择。

5 执行以下操作之一：

- 按  启用智能音频。显示屏在已启用旁边显示 。
 - 按  禁用智能音频。已启用旁边的  消失。
-



请参阅[授权附件列表](#)，了解建议的具有内置自动音量控制并已激活蓝牙功能的音频附件，可获取相似性能。



打开或关闭回声抑制器功能

通过此功能可以最小化您在接听电话时遇到的回声。

1 按  访问菜单。





2 按  或  显示实用程序，然后按  进行选择。

3 按  或  至对讲机设置，然后按  进行选择。

4 按  或  显示 AF 抑制器，然后按  进行选择。

您也可以使用 [或更改所选选项](#)。

5 执行以下操作之一。

- 按  启用回声抑制器。显示屏在已启用旁边显示 。
 - 按  禁用回声抑制器。已启用旁边的  消失。
-

打开或关闭 GNSS



全球导航卫星系统 (GNSS) 是一种卫星导航系统，用于确定对讲机的精确位置。GNSS 包括全球定位系统 (GPS)、全球导航卫星系统 (GLONASS) 和北斗导航卫星系统 (BDS)。



**说明:**

所选对讲机型号可提供 GPS、GLONASS 和 BDS。
GNSS 卫星群可使用 CPS 配置。咨询经销商或系统管理员以确定对讲机的预设情况。

1 执行以下操作之一：

- 按预设的 **GNSS** 按钮打开或关闭此功能。跳过以下步骤。
- 按  访问菜单。

2 按  或  显示设置。按  进行选择。

3 按  或  显示对讲机设置。按  进行选择。

4 按  或  显示 GNSS。按  进行选择。

5 按  启用/禁用 GNSS。

如果启用，已启用旁出现 。



如果禁用，已启用旁的  消失。

请参阅[检查 GNSS 信息 \(第 272 页\)](#)以获取有关 GNSS 的详细信息。

访问一般对讲机信息

对讲机包含下列信息：

- 电池
- 倾斜角度（加速计）
- 对讲机型号索引
- 选件板空中下载 (OTA) Codeplug CRC
- 站点编号
- 站点信息
- 对讲机别名和 ID
- 固件和 Codeplug 版本
- GNSS 信息

在任何时候按  都可以返回上一个屏幕或长按  返回主屏幕。不活动时计时器超时后，对讲机退出当前屏幕。

检查对讲机型号索引

该索引编号可用于识别对讲机型号的特定硬件。对讲机系统管理员会在为对讲机准备新选件板 Codeplug 时询问此编号。

- 1 按  访问菜单。

- 2 按  或  显示实用程序，然后按  进行选择。

- 3 按  或  显示对讲机信息，然后按  进行选择。



- 4 按  或  显示型号索引，然后按  进行选择。
屏幕显示型号索引。



检查选件板 OTA Codeplug 文件的 CRC



如果对讲机系统管理员要求您查看选件板 OTA Codeplug 文件 CRC（循环冗余校验），可按以下说明操作。该菜单选

项只在选件板接收到其上次 Codeplug 更新 OTA 时出现。

- 1 按  访问菜单。

- 2 按  或  显示实用程序，然后按  进行选择。

- 3 按  或  显示对讲机信息，然后按  进行选择。

- 4 按  或  显示 OB OTA CPcrc，然后按  进行选择。
屏幕显示一些字母和数字。将显示的信息准确告知对讲机系统管理员。

显示站点 ID（站点编号）



说明：

如果当前未在站点注册，屏幕显示未注册。

如果对讲机已在 **Connect Plus** 站点注册，则对讲机简要显示站点 ID。注册后，对讲机通常不会显示站点编号。要显示注册的站点编号，请执行以下操作：

- 1 按  访问菜单。

- 2 按  或  显示实用程序，然后按  进行选择。

- 3 按  或  显示对讲机信息，然后按  进行选择。

- 4 按  或  显示站点编号，然后按  进行选择。
屏幕显示网络 ID 和站点编号。

查看站点信息



说明：

如果当前未在站点注册，屏幕显示未注册。

站点信息功能为服务技术人员提供有用的信息。它包含以下信息：

- 当前控制信道中继器的中继器编号。
- 接收信号强度指示：从控制信道中继器测得的最后一个信号强度数值。
- 由控制信道中继器发送的邻近列表（由逗号隔开的五个数字）。

如果有人要求您使用此功能，请准确报告屏幕上显示的信息。

- 1 按  访问菜单。

- 2 按  或  显示实用程序，然后按  进行选择。

- 3 按  或  显示对讲机信息，然后按  进行选择。

- 4 按  或  显示站点信息，然后按  进行选择。
屏幕显示站点信息。

检查对讲机 ID

此功能可显示对讲机 ID。

按照如下所述的步骤通过对讲机的屏幕来访问此功能。



- 1 按  访问菜单。
- 2 按  或  显示实用程序，然后按  进行选择。
- 3 按  或  显示对讲机信息，然后按  进行选择。
- 4 按  或  显示我的 ID，然后按  进行选择。
显示屏会显示对讲机 ID。



查看固件版本和 Codeplug 版本

显示对讲机固件版本。

- 1 按  访问菜单。

- 2 按  或  显示实用程序，然后按  进行选择。

- 3 按  或  显示对讲机信息，然后按  进行选择。

- 4 按  或  显示版本，然后按  进行选择。

将显示列表和以下信息：

- (对讲机) 固件版本
- (对讲机) Codeplug 版本
- 选件板固件版本
- 选件板频率版本
- 选件板硬件版本
- 选件板 Codeplug 版本

检查更新

Connect Plus 提供通过无线 (OTA) 更新某些文件 (选件板 Codeplug、网络频率文件和选件板固件文件) 的能力。

**说明：**

咨询经销商或网络管理员以确定对讲机是否已启用此功能。

所有显示屏 **Connect Plus** 对讲机都可以使用菜单选项显示其当前选件板 **OTA Codeplug CRC**、频率文件版本或选件板固件文件版本。此外，已启用无线文件传输的显示屏对讲机可以显示“挂起文件”的版本。“挂起文件”是 **Connect Plus** 对讲机通过系统消息获取消息的频率文件或选件板固件文件，但是对讲机尚未接收所有文件包。如果显示屏 **Connect Plus** 对讲机有挂起的文件，菜单会提供选项：

- 查看挂起文件的版本号。
- 查看目前已接收包的百分比。
- 请求 **Connect Plus** 对讲机恢复接收文件包。

如果对讲机已启用 **Connect Plus** OTA 文件传输，对讲机可能会在未先通知对讲机用户的情况下自动加入文件传输。对讲机接收文件包时 **LED** 会快速闪烁红灯，对讲机会在主页的状态栏上显示大批量数据图标。

**说明：**

Connect Plus 对讲机无法同时接收文件包和接收呼叫。如果要取消文件传输，可按下再松开**通话按键**。该操作将使对讲机请求选定联系人姓名的呼叫并且还将取消对讲机的文件传输，直到过程在稍后恢复。

有几种方法可以再次开始传输过程。第一个示例适用于所有 **OTA** 文件类型。其他所有示例仅适用于网络频率文件和选件板固件文件：

- 对讲机系统管理员重新发起 **OTA** 文件传输。
- 选件板的预定义计时器超时将使选件板自动恢复接收包过程。
- 计时器未超时，但是对讲机用户通过菜单选项请求恢复文件传输。

Connect Plus 对讲机完成所有文件包下载后，它必须升级至新获得的文件。对于网络频率文件，该操作会自动进行并且不需要重置对讲机。对于选件板 **Codeplug** 文件，该操作会自动进行，选件板加载新 **Codeplug** 信息和重新获得网络站点时会短暂中断服务。对讲机升级到新选件板固件文件的速度取决于经销商或系统管理员在对讲机上所做的配置。对讲机将在接收所有文件包后立即升级或等到用户下次打开对讲机时升级。

**说明：**

咨询经销商或系统管理员以确定对讲机的预设情况。

升级到新选件板固件文件的过程需要几秒钟时间并且要求 **Connect Plus** 选件板重置对讲机。升级开始后，对讲机用户无法发起或接收呼叫，直到升级过程完成。在该过程中，对讲机屏幕会提示用户不要关闭对讲机。

固件文件

下节提供有关对讲机固件的信息。



固件为最新版本



说明：

如果选件板固件文件不为最新版本（或者对讲机已收集部分较新版本的选件板固件文件），对讲机会显示一个包括其他选项的列表：版本、已收到%和下载。



- 1 按  访问菜单。
- 2 按  或  显示实用程序，然后按  进行选择。
- 3 按  或  显示对讲机信息，然后按  进行选择。
- 4 按  或  显示更新，然后按  进行选择。

- 5 按  或  显示固件，然后按  进行选择。

屏幕显示固件为最新版本。

挂起的固件 - 版本

- 1 按  访问菜单。
- 2 按  或  显示实用程序，然后按  进行选择。
- 3 按  或  显示对讲机信息，然后按  进行选择。
- 4 按  或  显示更新，然后按  进行选择。
- 5 按  或  显示固件，然后按  进行选择。



- 6 按  或  显示版本，然后按  进行选择。



如果存在挂起的选件板固件文件，屏幕会显示挂起的固件版本号。

如果存在挂起的选件板固件文件，则屏幕显示固件为最新版本。

挂起的固件 – 已收到%

- 1 按  访问菜单。
- 2 按  或  显示实用程序，然后按  进行选择。
- 3 按  或  显示对讲机信息，然后按  进行选择。
- 4 按  或  显示更新，然后按  进行选择。

- 5 按  或  显示固件，然后按  进行选择。

- 6 按  或  显示已收到%，然后按  进行选择。

屏幕显示目前已接收固件文件包的百分比。









说明:



达到 100% 时，对讲机需要重启以启动固件升级。



挂起的固件 – 下载



如果 **Connect Plus** 对讲机之前离开 OTA 选件板固件文件传输时已接收部分文件，对讲机会在内部计时器超时后自动重新加入文件传输（如果仍在进行）。如果要让对讲机在内部计时器超时前重新加入正在进行的选件板固件文件传输，可使用下述下载选项。

- 1 按  访问菜单。
- 2 按  或  显示实用程序，然后按  进行选择。

3 按  或  显示对讲机信息，然后按  进行选择。

4 按  或  显示更新，然后按  进行选择。

5 按  或  显示固件，然后按  进行选择。

6 按  或  显示下载，然后按  进行选择。

屏幕将显示以下状态：

下载可用	开始下载
不提供下载	下载不可用

7 执行以下操作之一：

- 选择是，然后按  开始下载。
- 选择否，然后按  返回上一级菜单。

频率文件

下节提供有关对讲机的频率文件信息。

频率文件为最新版本









说明：

如果频率文件不为最新版本（或者对讲机已收集部分较新版本的频率文件），对讲机会显示一个包括其他选项的列表：版本、已收到%和下载。

1 按  访问菜单。

2 按  或  显示实用程序，然后按  进行选择。

3 按  或  显示对讲机信息，然后按  进行选择。

4 按  或  显示频率，然后按  进行选择。

屏幕在第一行显示频率文件为最新版本。

频率文件挂起 - 版本

- 1 按  访问菜单。
- 2 按  或  显示实用程序，然后按  进行选择。
- 3 按  或  显示对讲机信息，然后按  进行选择。
- 4 按  或  显示更新，然后按  进行选择。
- 5 按  或  显示频率，然后按  进行选择。
- 6 按  或  显示版本，然后按  进行选择。

如果存在挂起的频率文件，屏幕会显示挂起的频率文件版本号。

频率文件挂起 - % 已接收

- 1 按  访问菜单。
 - 2 按  或  显示实用程序，然后按  进行选择。
 - 3 按  或  显示对讲机信息，然后按  进行选择。
 - 4 按  或  显示更新，然后按  进行选择。
 - 5 按  或  显示已收到%，然后按  进行选择。
- 屏幕显示目前已接收频率文件包的百分比。



频率文件挂起 - 下载



如果 **Connect Plus** 对讲机之前离开 OTA 网络频率文件传输时已接收部分文件，对讲机会在内部计时器超时后自动重新加入文件传输（如果仍在进行）。如果要让对讲机在内部计



时器超时前重新加入正在进行的网络频率文件传输，可使用下述下载选项。



1 按  访问菜单。

2 按  或  显示实用程序，然后按  进行选择。

3 按  或  显示对讲机信息，然后按  进行选择。

4 按  或  显示更新，然后按  进行选择。

5 按  或  显示频率，然后按  进行选择。

6 按  或  显示下载，然后按  进行选择。

下载当前不可用

下载不可用

下载当前可用

开始下载

7 执行以下操作之一：



- 选择是，然后按 开始下载。
- 选择否，然后按 返回上一级菜单。



检查 GNSS 信息



在对讲机上显示 GNSS 信息，如以下值：



- 纬度
- 经度
- 海拔高度
- 方向
- 速率
- 水平精度因子 (HDOP)
- 卫星
- 版本

1 按  访问菜单。

2 按  或  显示实用程序，然后按  进行选择。

3 按  或  显示对讲机信息，然后按  进行选择。

4 按  或  显示 GNSS 信息，然后按  进行选择。

5 按  或  显示所需的项目，然后按  进行选择。



显示屏显示所请求的 GNSS 信息。



有关 GNSS 的详细信息，请参阅[打开或关闭 GNSS \(第 262 页\)](#)。



查看企业 Wi-Fi 证书详细信息

您可以查看选定企业 Wi-Fi 证书的详细信息。

1 按  访问菜单。

2 按  或  显示设置。按  进行选择。

3 按  或  至证书菜单。按  进行选择。
✓ 出现在就绪证书旁边。

4 按  或  显示所需证书。按  进行选择。

对讲机显示证书的完整详细信息。



说明:

对于未就绪证书，显示屏仅显示“状态”。

其他系统

本章说明对讲机用户在本系统中可以使用的功能。

通话按键

通话按键 (PTT) 按钮有两个基本用途：

- 正在进行呼叫时，**PTT** 按钮可让对讲机向该呼叫中的其他对讲机发射信号。按下 **PTT** 按钮时，可激活麦克风。
- 当不进行呼叫时，**PTT** 按钮用于发起一次新呼叫。

长按 **PTT** 按钮开始讲话。释放 **PTT** 按钮接听。

如果启用了通话许可音或 **PTT** 侧音 ，则等待短提示音结束后即可开始通话。

 如果您的对讲机激活了“信道空闲提示”功能（经销商进行了预设），则当日标对讲机（接收您呼叫的对讲机）释放 **PTT** 时，您将会听到一声短提示音，表示此信道空闲，等待您回答。

 如果呼叫中断，您将听到一声连续的通话禁止提示音。如果您听到连续的通话禁止提示音，您应该释放 **PTT** 按钮。

可预设按钮

根据按下按钮的持续时间，您的经销商可将可预设按钮设置为对讲机功能的快捷键。

短按

快速按下并释放。

长按

按住然后保持预设的时间。



说明：

请参阅[紧急操作 \(第 339 页\)](#)详细了解[紧急呼叫按钮](#)的预设持续时间。

可分配的对讲机功能

可将以下对讲机功能分配到可编程的按钮。

音频环境

允许用户选择对讲机的工作环境。

音频配置文件

允许用户选择首选音频配置文件。

蓝牙® 音频切换

在内部对讲机扬声器和已启用蓝牙功能的外部附件之间切换音频路由。

蓝牙连接

启动蓝牙查找并连接操作。

蓝牙断开

终止您的对讲机和任何已启用蓝牙的设备之间的所有现有蓝牙连接。

蓝牙可发现

使对讲机进入蓝牙可发现模式。

呼叫提示

提供对通讯录列表的直接访问，以便您选择一个联系人并向其发送呼叫提示。

呼叫转移

打开或关闭呼叫转移。

通话记录

选择通话记录列表。

信道通知

播放当前信道的区域和信道语音通知信息。

通讯录

用于直接访问通讯录列表。

紧急呼叫

根据预设，发起或取消紧急呼叫。

外部公共广播 (PA)

在已连接的 PA 扬声器放大器和对讲机内部 PA 系统之间切换音频路由。

室内定位

打开或关闭室内定位。

智能音频

打开或关闭智能音频。

手动拨号

通过键入任何用户 ID 发起单呼。

手动站点漫游 ⁷

启动手动站点搜索。

麦克风 AGC

打开或关闭内部麦克风自动增益控制 (AGC) 功能。

监听

监听所选信道中的任何活动。

通知

提供对通知列表的直接访问。

无用信道删除 ⁷

除选定信道外，从扫描列表中暂时删除一个无用信道。选定信道是指发起扫描的用户所选的区域或信道的组合。

⁷ 在智能信道共享中不适用。

单键接入

直接发起预定义的单呼、电话呼叫或组呼、呼叫提示、预制短信或复原返回。

选件板功能

在支持选件板功能的信道上打开或关闭选件板功能。

永久监听 ⁷

监听一个选定信道的所有对讲机通信，直至禁用该功能。

电话

用于直接访问电话通讯录列表。

加密

打开或关闭加密。

公共广播 (PA)

打开或关闭对讲机内部 PA 系统。

对讲机别名和 ID

提供对讲机别名和 ID。

对讲机检测

确定系统内的对讲机是否激活。

对讲机遥控

允许远程禁用目标对讲机。

对讲机激活

允许远程启用目标对讲机。

远程监听

开启目标对讲机的麦克风，而不点亮任何指示灯。

中继器/脱网 ⁷

在使用中继器和直接与其他对讲机通信之间切换。

重置主信道

设置新的主信道。

静音主信道提醒

静音主信道提醒。

扫描 ⁸

打开或关闭扫描。

站点信息

显示当前智能信道共享多站点的站点名称和 ID。

启用语音提示时，播放当前站点的语音提示信息。

站点锁定 ⁷

切换为打开时，对讲机只搜索当前站点。切换为关闭时，对讲机将搜索当前站点和其他站点。

遥感遥测控制

控制本地或远程对讲机上的输出引脚。

⁸ 在智能信道共享--单站点中不适用。

短信

选择短信菜单。

发射中断远程停止

中止进行中的可中断呼叫以释放信道。

颤音增强功能

打开或关闭颤音增强功能。

语音提示开/关

打开或关闭语音提示。

声控发射 (VOX)

打开或关闭 VOX。

Wi-Fi

打开或关闭 Wi-Fi。

区域选择

允许从区域列表中选择。

可分配的设置或实用功能

可将以下对讲机设置或实用功能分配到可编程的按钮。

音调/提示

打开或关闭全部音调和提示。

背光

打开或关闭屏幕背光。

信道上调/下调

根据预设，将信道切换至上一信道或下一信道。

显示模式

在日间/夜间显示模式之间进行切换。

电量级别

在高低功率之间切换发射功率级别。

访问预设的功能

按照步骤访问对讲机中预设的功能。

1 执行以下操作之一：

- 按预设的按钮。继续 [步骤 3](#)。
- 按  访问菜单。

2 按 或 显示菜单功能，然后按 选择功能或进入子菜单。

3 执行以下操作之一：

- 按  返回前一屏幕。
- 长按  返回主屏幕。

一段时间不活动后对讲机将自动退出菜单并返回主屏幕。

键盘麦克风上也可使用菜单导航按钮。请参阅[键盘麦克风按钮 \(第 28 页\)](#)。

状态指示灯

本章介绍对讲机中使用的状态指示灯和音频提示音。

图标

对讲机的液晶显示屏 (LCD) 显示对讲机状态、文本条目和菜单条目。

表 9: 显示屏图标

以下图标出现在对讲机显示屏顶部的状态栏中。图标按出现或使用顺序排列在最左侧，并为信道特定图标。

	仅 BeiDou 可用⁹ 已启用仅 BeiDou 功能。定位可用时，该图标亮起。
---	---

	蓝牙已连接 蓝牙功能已启用。当连接了一个远程蓝牙设备时，此图标将保持亮起状态。
	未连接蓝牙 蓝牙功能已启用，但尚未连接远程蓝牙设备。
	通话记录 对讲机通话记录。
	联系人 对讲机联系人可用。
	紧急呼叫 对讲机处于紧急呼叫模式。
	灵活接收列表 灵活接收列表已启用。
	GNSS 可用 GNSS 功能已启用。定位可用时，该图标亮起。

⁹ 仅适用于 XiR M8660i/XiR M8668i/CM7668i。

	GNSS 不可用 ¹⁰ GNSS 功能已启用，但未接收到卫星数据。
	大批量数据 对讲机正在接收大批量数据，信道处于繁忙状态。
	室内定位可用 ¹⁰ 室内定位状态已打开并可用。
	室内定位不可用 ¹⁰ 室内定位状态已打开但不可用，这是因为蓝牙已禁用或信标扫描通过蓝牙挂起。
	消息 收到的信息。
	监听 正在监听所选信道。
	静音模式 静音模式已启用，扬声器已静音。

	通知 通知列表中有一个或多个错过的事件。
	选件板 选件板已启用。（仅已激活选件板的型号。）
	选件板不工作 选件板已禁用。
	无线编程延迟计时器 表示自动重新启动对讲机之前剩余的时间。
	接收信号强度指示器 (RSSI) 显示的信号强度柱数目表示对讲机信号强度。四个信号强度柱表示信号的强度最强。只有在接收时才显示该图标。
	响应抑制 响应抑制已启用。

¹⁰ 仅适用于具有最新软件和硬件的型号。

	仅响铃 已激活铃声模式。
	扫描¹¹ 扫描功能已启用。
	扫描-优先级 1¹¹ 对讲机检测指定为优先级 1 的信道/通话组上的活动。
	扫描-优先级 2¹¹ 对讲机检测指定为优先级 2 的信道/通话组上的活动。
	安全 加密功能已启用。
	登录 对讲机已登录到远程服务器。
	注销 对讲机已从远程服务器注销。

	静音 已激活静音模式。
	站点漫游¹² 已启用漫游功能。
	脱网¹¹ 在无中继器时，对讲机配置为对讲机到对讲机的直接通信。
	提示音禁用 提示音已关闭。
	不安全 加密功能已禁用。
	投票扫描 投票扫描功能已启用。
	Wi-Fi 极佳¹³ Wi - Fi 信号极佳。

¹¹ 在智能信道共享中不适用。



¹² 在智能信道共享 - 单站点中不适用。

¹³ 仅适用于 XiR M8668i/CM7668i。

	Wi-Fi 良好 ¹³ Wi-Fi 信号良好。
	Wi-Fi 中等 ¹³ Wi-Fi 信号中等。
	Wi-Fi 较差 ¹³ Wi-Fi 信号弱。
	Wi-Fi 不可用 ¹³ Wi-Fi 信号不可用。

表 10: 高级菜单图标

以下图标显示在菜单项旁边，这些图标供用户在两个选项之间进行选择或者向用户表明有一个可提供两个选项的子菜单。

	复选框 (选中) 表示已选择选项。
	复选框 (未选中) 表示未选择选项。

	实心黑框 表示为包含子菜单的菜单项所选择的选项。
---	------------------------------------

表 11: 蓝牙设备图标

以下图标显示在可用的已启用蓝牙功能的设备列表中的列表项旁边，用于指示设备类型。







	蓝牙音频设备 已启用蓝牙功能的音频设备，例如耳机。
	蓝牙数据设备 已启用蓝牙功能的数据设备，例如扫描器。
	蓝牙 PTT 设备 已启用蓝牙功能的 PTT 设备，例如仅具备 PTT 功能的设备 (POD)。

表 12: 呼叫图标

以下图标在呼叫过程中出现在显示屏上。这些图标也出现在通讯录列表中，表示别名或 ID 类型。

	<p>蓝牙 PC 呼叫 表示正在进行蓝牙 PC 呼叫。</p> <p>在“通讯录”列表中，它表示蓝牙 PC 呼叫别名（名称）或 ID（编号）。</p>
	<p>调度呼叫 调度呼叫联系人类型用于通过第三方短信服务器给调度员 PC 发送短信。</p>
	<p>组呼/全呼 表示正在进行组呼或全呼。</p> <p>在“通讯录”列表中，它表示通话组别名（名称）或 ID（编号）。</p>
	<p>单呼 表示正在进行单呼。在“通讯录”列表中，它表示用户别名（名称）或 ID（编号）。</p>
	<p>组呼/全呼电话呼叫 表示正在进行组呼或全呼电话呼叫。</p>

在“通讯录”列表中，它表示通话组别名（名称）或 ID（编号）。







单呼电话呼叫

表示正在进行“单呼电话呼叫”。

在“通讯录”列表中，它表示电话别名（名称）或 ID（编号）。

表 13: 任务图标

以下图标会短暂显示在显示屏的“任务”文件夹中。

	<p>所有作业 表示已列出所有作业。</p>
	<p>新作业 表示已列出新作业。</p>
	<p>进行中 作业正在传输。这是会在“任务发送失败”或“发送成功”指示前看到。</p>
	<p>发送失败 作业无法发送。</p>

	发送成功 作业已成功发送。
	优先级 1 表示作业的优先级 1。
	优先级 2 表示作业的优先级 2。
	优先级 3 表示作业的优先级 3。

表 14: 小型通知图标

在采取执行任务的操作后，显示屏上会短暂显示以下图标。





	发射失败（否定） 操作执行失败。
	发射成功（确定） 操作执行成功。
	正在发射（发射中） 正在发射。在指示发射成功或发射失败时显示。

表 15: 已发信息图标

以下图标显示在显示屏右上角的已发信息文件夹中。

 或 	进行中 至某一用户别名或 ID 的短信正在等待发送，然后等待确认。 至某一通话组别名或 ID 的短信正在等待发送。
 或 	已读单条或群组信息 已读短信。
 或 	未读单条或群组信息 短信未读。
 或 	发送失败 短信无法发送。

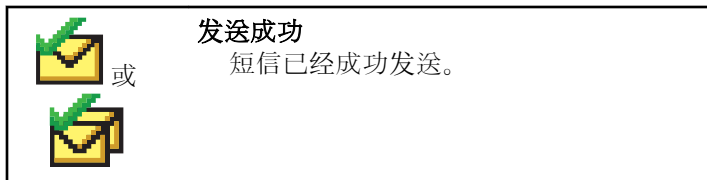

LED 指示灯

LED 指示灯显示对讲机的工作状态。

呈红色闪烁

开机后对讲机自检失败。

对讲机正在接收紧急发射信号。

对讲机正在低电池电量状态下发射。

如果配置了自动范围应答机系统，对讲机已移至范围以外。

已启用静音模式。

稳定绿色

对讲机正在开机。

对讲机正在传输信号。

对讲机正在发送呼叫提示或紧急呼叫传输。

呈绿色闪烁

对讲机正在接收呼叫或数据。

对讲机正在检索无线编程传输信号。

对讲机正在通过无线检测活动。



说明:

由于数字协议的特性，此活动可能会也可能不会影响对讲机的预设信道。

当对讲机在通过智能信道共享模式检测无线活动时，没有 LED 指示。

绿灯双闪

对讲机正在接收加密呼叫或数据。

稳定黄色

对讲机正在监听某个传统信道。

对讲机处于蓝牙可发现模式。

呈黄色闪烁

对讲机正在扫描活动。

对讲机尚未响应呼叫提示。

对讲机已启用灵活接收列表。

所有智能信道共享--多站点的信道均处于繁忙状态。

黄灯双闪

对讲机已启用自动漫游功能。

对讲机正在主动搜索新站点。

对讲机尚未响应组呼提示。

对讲机被锁定。

智能信道共享模式下，对讲机不与中继器连接。

所有智能信道共享模式的信道均处于繁忙状态。

提示音

以下是通过对讲机扬声器发出的提示音。



高音调提示音



低音调提示音

提示音

在采取执行任务的操作后，提示音为您提供状态的声音提示。



确定提示音



否定提示音

音频提示音

音频提示音通过声音向您发出有关对讲机状态或对讲机对所接收的数据进行的响应的提示。



连续音

发出单调音。连续发音直至终止。



周期音

根据对讲机设定的持续时间周期发音。铃音自我启动、停止和重复。



重复音

自我重复的单音，直至用户将其终止。



瞬间音

根据对讲机设定的短持续时间发出一次。

传统模拟和数字模式

对讲机中的每个信道都可配置为传统模拟信道或传统数字信道。

使用**信道选择按钮**在模拟或数字信道之间进行切换。

从数字模式切换到模拟模式时，某些功能不可用。数字功能的图标通过“变灰”来反应此变化。菜单会隐藏禁用功能。

对讲机也有在模拟和数字模式下均可使用的功能。各种功能工作方式之间的微小差别不影响对讲机性能。



说明：

在双模扫描期间，对讲机也可以在数字模式和模拟模式之间进行切换。有关详细信息，请参阅[扫描 \(第 323 页\)](#)。

图标信息

在本手册中，所述的图标用于表示在传统模拟模式或传统数字模式中支持的功能，或通过支持键盘的麦克风使用。



表示**仅在传统模拟模式**下有效的功能。



表示**仅在传统数字模式**下有效的功能。

对于在传统模拟和数字模式下**均**可用的功能，两个图标均不显示。

IP 站点连接

此功能允许您的对讲机连接至通过互联网协议 (IP) 网络连接的不同可用站点，从而将传统通信扩展到单个站点范围之外。这是传统的多站点模式。

当对讲机从一个站点的范围移到另一个站点的范围内时，对讲机连接到新站点的中继器以发送或接收呼叫或数据传输信号。这可以自动或手动完成，具体取决于您的设置。

在自动站点搜索中，当来自当前站点的信号较弱或对讲机无法检测到来自当前站点的任何信号时，对讲机将扫描所有可用站点。对讲机然后锁定具有最强接收信号强度指示 (RSSI) 值的中继器。

在手动站点搜索中，对讲机搜索漫游列表中当前在范围内的下一个站点（但该站点可能不具有最强的信号）并锁定该站点。



说明：

每个信道只能激活“扫描”或“漫游”，但不能同时激活这两者。

可以将激活了此功能的信道添加到特定的漫游列表中。在自动漫游操作过程中，对讲机搜索漫游列表中的信道以确定最佳站点。一个漫游列表最多支持 **16** 个信道（包括选定的信道）。

**说明:**

您不能在漫游列表中手动添加或删除条目。请联系您的经销商或系统管理员了解详情。

智能信道共享--单站点

“智能信道共享--单站点”是 MOTOTRBO 对讲机系统中的单站点集群配置，它使用信道池支持数百个用户以及最多 **254** 个通话组。此功能允许您的对讲机在处于中继器模式时有效地利用多个可用的预设信道。

如果您尝试使用可预设按钮访问不适用于“智能信道共享--单站点”的功能，您将听到一声否定提示音。

您的对讲机还有在传统数字模式、IP 站点连接、智能信道共享中均可使用的功能。然而，各种功能工作方式之间的微小差别不影响对讲机性能。

有关此配置的详细信息，请咨询您的经销商或系统管理员。

智能信道共享--多站点

“智能信道共享--多站点”是 MOTOTRBO 对讲机系统中的多信道集群配置，它将智能信道共享和 IP 站点连接配置的优点结合在了一起。

“智能信道共享--多站点”允许您的对讲机连接至使用 IP 网络连接的不同可用站点，从而将集群通信扩展到单个站点范围

之外。它还通过有效利用每个可用站点支持的一系列可用预设信道的组合增加了容量。

当对讲机从一个站点的范围移到另一个站点的范围内时，对讲机连接到新站点的中继器以发送或接收呼叫/数据传输信号。根据您的设置，此操作可以自动或手动进行。

如果将对讲机设置为自动执行此操作，则当来自当前站点的信号较弱或对讲机无法检测到来自当前站点的任何信号时，它将扫描所有可用站点。然后，它将锁定具有最强 **RSSI** 值的中继器。

在手动站点搜索中，对讲机搜索漫游列表中当前在范围内的下一个站点（但该站点可能不具有最强的信号）并锁定该站点。

任何启用了“智能信道共享--多站点”的信道均可添加到特定的漫游列表中。在自动漫游操作过程中，对讲机将搜索这些信道以确定最佳站点。

**说明:**

您不能在漫游列表中手动添加或删除条目。请联系您的经销商或系统管理员了解详情。

与“智能信道共享--单站点”类似，不适用于“智能信道共享--多站点”的功能的图标将不显示在菜单中。如果您尝试使用可预设按钮访问不适用于“智能信道共享--多站点”的功能，您将听到一声否定提示音。

区域和信道选择

本章介绍了在对讲机上选择区域或信道的操作。区域是一个信道组。

您的对讲机最多支持 **99** 个信道和 **2** 个区域，每个区域最多 **99** 个信道。





每个信道均可使用不同的功能预设和/或支持不同的用户组。



选择区域

按照步骤在对讲机上选择所需的区域。

1 执行以下操作之一：

- 按预设的**区域选择**按钮。继续 **步骤 3**。
- 按  访问菜单。

2 按  或  显示区域。按  进行选择。
显示屏显示  和当前区域。





3 按  或  显示所需区域。按  进行选择。

显示屏短暂显示<区域> 已选择，然后返回所选区域屏幕。

使用别名搜索选择区域

按照步骤使用别名搜索在对讲机上选择所需的区域。

1 按  访问菜单。

2 按  或  显示区域。按  进行选择。
显示屏显示  和当前区域。

3 输入所需别名的第一个字符。
显示屏显示一个闪烁的光标。

4 输入所需别名的其余字符。

别名搜索不区分大小写。如果有两个或两个以上名称相同的条目，对讲机将显示列表中首先列出的条目。

第一行文字显示您输入的字符。接下来的几行文字显示筛选后的搜索结果。

5 按  进行选择。

显示屏短暂显示<区域> 已选择，然后返回所选区域屏幕。

选择信道

按照步骤在选择区域后在对讲机上选择所需的信道。

执行以下操作之一：

- 按向上/向下滚动按钮。
 - 使用音量/信道旋钮。
 - 按预设的信道上调/下调按钮。
-

呼叫

本章介绍了接收、回复、发出和停止呼叫的操作。

在使用以下一种功能选择了信道后，您可以选择一个用户名或 ID、或通话组别名或 ID：

别名搜索

此方法用于仅使用键盘麦克风的组呼、单呼和全呼。

通讯录列表

此方法用于直接访问通讯录列表。

手动拨号（使用通讯录）

此方法用于仅使用键盘麦克风的单呼和电话呼叫。

预设的数字键

此方法用于仅使用键盘麦克风的组呼、单呼和全呼。



说明：

一个数字键只能分配有一个别名或 ID，但您可以使多个数字键与一个别名或 ID 相关联。可以分配键盘麦克风上的所有数字键。有关详细信息，请参阅[将条目分配至可编程数字键 \(第 327 页\)](#)。

预设的单键接入按钮

此方法仅用于组呼、单呼和电话呼叫。

通过短按或长按可预设的按钮，您只能将一个 ID 分配给一个单键接入按钮。对讲机可以有多个预设的单键接入按钮。

可预设按钮

此方法仅用于电话呼叫。

音量/信道选择旋钮

此方法可手动选择用户别名或 ID、或通话组别名或 ID。

当对讲机发射时 LED 绿灯长亮，对讲机接收时为绿灯闪烁。



说明：

当对讲机发射时 LED 绿灯长亮，对讲机接收加密呼叫时指示灯的状态为绿灯双闪。

要对加密呼叫进行解密，您的对讲机必须拥有与发射对讲机（您从其接收呼叫的对讲机）相同的加密密钥，或相同的密钥值和密钥 ID（经销商进行了预设）。

有关详细信息，请参阅[加密 \(第 369 页\)](#)。

组呼

您的对讲机必须配置为通话组的一部分，才能从用户通话组接收呼叫或向用户通话组发起呼叫。

发起组呼

按照步骤在对讲机上发起组呼。

- 1 执行以下操作之一：
 - 选择具有活动通话组别名或 ID 的信道。

- 按预设的**单键接入**按钮。

2 按 PTT 键发起呼叫。

LED 绿灯亮起。显示屏将显示**组呼**图标和组呼别名。

3 释放 PTT 按钮接听。

当目标对讲机做出响应时，LED 绿灯亮起。显示屏显示**组呼**图标、组别名或 ID，以及发射对讲机别名或 ID。

- 4  如果启用“信道空闲提示”功能，则当发射对讲机释放 PTT 时，您将会听到一声短的提示音，表示此信道空闲，您可以应答。按 PTT 来回复该呼叫。

在预定时间内无语音活动时，呼叫结束。对讲机将返回至发起呼叫前的屏幕。

使用通讯录列表发起组呼

按照步骤使用通讯录列表在对讲机上发起组呼。

- 1 按  OK 访问菜单。

- 2 按  或  显示通讯录。按  进行选择。

- 3 按  或  显示所需的别名或 ID。按  进行选择。

- 4 按 **PTT 键**发起呼叫。
LED 绿灯亮起。

- 5 释放 **PTT 按钮**接听。
当组内任何用户回复时，LED 绿灯闪烁。显示屏显示 **组呼**图标、别名或 ID，以及发射对讲机别名或 ID。

- 6  如果启用“信道空闲提示”功能，则当发射对讲机释放 **PTT** 时，您将会听到一声短的提示音，表示此信道空闲，您可以应答。按 **PTT** 来回复该呼叫。
在预定时间内无语音活动时，呼叫结束。

如果将数字键分配至特定模式下的一个条目，当您在另一种模式下长按此数字键时，将无法支持该功能。

如果数字键未与条目相关联，会响起一声否定提示音。

- 2 按 **PTT 键**发起呼叫。
LED 绿灯亮起。

- 3 释放 **PTT 按钮**接听。
当组内任何用户回复时，LED 绿灯闪烁。

- 4  如果启用“信道空闲提示”功能，则当发射对讲机释放 **PTT** 时，您将会听到一声短的提示音，表示此信道空闲，您可以应答。按 **PTT** 来回复该呼叫。
在预定时间内无语音活动时，呼叫结束。对讲机返回到发起呼叫前您所在的屏幕。

有关详细信息，请参阅[将条目分配至可编程数字键 \(第 327 页\)](#)。

使用可预设的数字键发起组呼

按照步骤使用可预设的数字键在对讲机上发起组呼。

- 1 在主屏幕上时，长按可预设的数字键显示预定义的别名或 ID。



回复组呼

要接收来自用户组的呼叫，对讲机必须配置为属于该通话组。按照步骤在对讲机上回复组呼。

当您接收组呼时：

- LED 绿灯闪烁。
- 显示屏右上角显示**组呼**图标。
- 第一行文字显示呼叫方别名。
- 第二行文字显示组呼别名。
- 对讲机取消静音，呼入电话会通过扬声器发出声音。

1 执行以下操作之一：

-  如果启用“信道空闲提示”功能，则当发射对讲机释放 **PTT** 时，您将会听到一声短的提示音，表示此信道空闲，您可以应答。按 **PTT** 来回复该呼叫。
-  如果语音中断功能已启用，则按**通话按键**中止来自发射对讲机的音频，以释放信道供您做出应答。

LED 绿灯亮起。

2 执行以下操作之一：

- 等通话许可提示音结束后（启用该功能时）对着麦克风清楚地讲话。
-  等 **PTT** 侧音结束后（启用该功能时）对着麦克风清楚地讲话。

3 释放 **PTT** 按钮接听。

在预定时间内无语音活动时，呼叫结束。

如果对讲机接收到一个组呼，而此时不在主屏幕，它在回复该呼叫之前保持在当前屏幕。

长按  以返回到主屏幕，在回复之前查看呼叫方别名。

单呼

单呼是由一台个体对讲机对另一台个体对讲机的呼叫。

有两种单呼设置方法。第一种是在执行对讲机存在检测后设置呼叫，第二种是立即设置呼叫。经销商只可将其中的一种预设到对讲机中。

发起单呼

您的对讲机必须经过预设才能发起单呼。如果未启用此功能，则当您发起呼叫时，会发出一声否定提示音。按照步骤在对讲机上发起单呼。

使用短信或呼叫提示功能与单个对讲机联系。有关详细信息，请参阅[短信发送 \(第 117 页\)](#)或[呼叫提醒操作 \(第 335 页\)](#)。

1 执行以下操作之一：

- 选择具有活动用户别名或 ID 的信道。
- 按预设的**单键接入**按钮。

2 按 **PTT 键**发起呼叫。

LED 绿灯亮起。显示屏显示**单呼**图标、用户别名和呼叫状态。

3 等通话许可提示音结束后（启用该功能时）对着麦克风清楚地讲话。

4 释放 **PTT** 按钮接听。

当目标对讲机做出响应时，LED 绿灯闪烁。



5  如果启用“信道空闲提示”功能，则当发射对讲机释放 **PTT** 时，您将会听到一声短的提示音，表示此信道空闲，您可以应答。按 **PTT** 来回复该呼叫。



在预定时间内无语音活动时，呼叫结束。将发出一声提示音。屏幕显示呼叫结束。

使用通讯录列表发起单呼

按照步骤使用通讯录列表在对讲机上发起单呼。

1 按  访问菜单。

2 按  或  显示通讯录。按  进行选择。

3 按  或  显示所需的别名或 ID。按  进行选择。

4 按 **PTT 键**发起呼叫。

LED 绿灯亮起。屏幕显示目标别名。

5 等通话许可提示音结束后（启用该功能时）对着麦克风清楚地讲话。

6 释放 **PTT** 按钮接听。

当目标对讲机做出响应时，LED 绿灯闪烁。显示屏显示发送用户别名或 ID。



7  如果启用“信道空闲提示”功能，则当发射对讲机释放 **PTT** 时，您将会听到一声短的提示音，表示此信道空闲，您可以应答。按 **PTT** 来回复该呼叫。



在预定时间内无语音活动时，呼叫结束。将发出一声提示音。屏幕显示呼叫结束。



使用手动拨号发起单呼

按照步骤使用手动拨号在对讲机上发起单呼。



1 按  访问菜单。

2 按  或  显示通讯录。按  进行选择。

3 按  或  显示手动拨号。按  进行选择。

4 按  或  显示号码。按  进行选择。

5 执行以下操作之一：

- 输入用户 ID，然后按  继续。
 - 编辑之前拨叫的用户 ID，然后按  继续。
-

6 按 **PTT** 键发起呼叫。

LED 绿灯亮起。屏幕显示目标别名。

7 等通话许可提示音结束后（启用该功能时）对着麦克风清楚地讲话。

8 释放 **PTT** 按钮接听。

当目标对讲机做出响应时，LED 绿灯亮起。显示屏显示发送用户别名或 ID。

9  如果启用“信道空闲提示”功能，则当发射对讲机释放 **PTT** 时，您将会听到一声短的提示音，表示此信道空闲，您可以应答。按 **PTT** 来回复该呼叫。

在预定时间内无语音活动时，呼叫结束。将发出一声提示音。屏幕显示呼叫结束。

使用可预设的数字键发起单呼

按照步骤使用可预设的数字键在对讲机上发起单呼。

- 1 在主屏幕上时，长按可预设的数字键显示预定义的别名或 ID。

如果将数字键分配至特定模式下的一个条目，当您在另一种模式下长按此数字键时，将无法支持该功能。

如果数字键未与条目相关联，会响起一声否定提示音。

- 2 按 **PTT 键**发起呼叫。

LED 绿灯亮起。显示屏右上角显示**单呼**图标。第一行文字显示呼叫方别名。第二行文字显示呼叫状态。

- 3 释放 **PTT** 按钮接听。

当目标对讲机做出响应时，LED 绿灯闪烁。屏幕显示目标别名。

- 4  如果启用“信道空闲提示”功能，则当发射对讲机释放 **PTT** 时，您将会听到一声短的提示音，表示此信道空闲，您可以应答。按 **PTT** 来回复该呼叫。

在预定时间内无语音活动时，呼叫结束。将发出一声提示音。对讲机返回到发起呼叫前您所在的屏幕。

有关详细信息，请参阅[将条目分配至可编程数字键 \(第 327 页\)](#)。



回复单呼

按照步骤在对讲机上回复单呼。

当您接收单呼时：

- LED 绿灯闪烁。
- 对讲机取消静音，呼入电话会通过扬声器发出声音。

- 1 执行以下操作之一：

-  如果启用“信道空闲提示”功能，则当发射对讲机释放 **PTT** 时，您将会听到一声短的提示音，表示此信道空闲，您可以应答。按 **PTT** 来回复该呼叫。
-  如果发射中断远程停止功能已启用，则按 **PTT** 按钮停止进行中的可中断呼叫以释放信道供您做出响应。

LED 绿灯亮起。

2 等通话许可提示音结束后（启用该功能时）对着麦克风清楚地讲话。

3 释放 **PTT** 按钮接听。

在预定时间内无语音活动时，呼叫结束。

全呼

全呼是由一台个体对讲机对信道上所有对讲机的呼叫。全呼用于做出需要用户充分注意的重要通告。信道上的用户无法回复全呼。

接收全呼

当您接收全呼时：

- 将发出一声提示音。
- LED 绿灯闪烁。
- 显示屏右上角显示**组呼**图标。
- 第一行文字显示呼叫方别名 ID。
- 第二行文字显示全呼。
- 对讲机取消静音，呼入电话会通过扬声器发出声音。

在呼叫结束时，对讲机返回接收全呼前的屏幕。

全呼不会等待预定时间，会直接终止。

● 如果启用“信道空闲提示”功能，则当发射对讲机释放**通话按键**时，您将会听到一声短提示音，表示此信道可供您使用。

您无法回复全呼。



说明：

在接收全呼时，如果您切换至另一个信道，则对讲机停止接收该全呼。您无法继续任何菜单导航或编辑，直至全呼结束。

发起全呼

您的对讲机必须经过预设才能发起全呼。按照步骤在对讲机上发起全呼。

1 选择具有活动全呼通话组别名或 ID 的信道。

2 按 **PTT 键**发起呼叫。

LED 绿灯亮起。显示屏将显示**组呼**图标和全呼。

3 执行以下操作之一：

- 等通话许可提示音结束后（启用该功能时）对着麦克风清楚地讲话。

-  等 **PTT** 侧音结束后（启用该功能时）对着麦克风清楚地讲话。

信道上的用户无法回复全呼。

使用可预设的数字键发起全呼

按照步骤使用可预设的数字键在对讲机上发起全呼。

- 1 在主屏幕上时，长按分配给预定义别名或 ID 的预设数字键。

如果将数字键分配至特定模式下的一个条目，当您在另一种模式下长按此数字键时，将无法支持该功能。

如果数字键未与条目相关联，会响起一声否定提示音。

- 2 按 **PTT** 键发起呼叫。

LED 绿灯亮起。

- 3 释放 **PTT** 按钮接听。

当目标对讲机做出响应时，LED 绿灯亮起。目前，您无法回复全呼。

- 4  如果启用“信道空闲提示”功能，则当发射对讲机释放 **PTT** 时，您将会听到一声短的提示音，表示此信道空闲，您可以应答。按 **PTT** 来回复该呼叫。

在预定时间内无语音活动时，呼叫结束。对讲机将返回至发起呼叫前的屏幕。

对于单呼，呼叫结束时您将听到一声简短的提示音。

有关详细信息，请参阅[将条目分配至可编程数字键 \(第 327 页\)](#)。

选择呼叫

选择性呼叫是由一台个体对讲机对另一台个体对讲机的呼叫。它是在模拟系统中进行的单呼。

发起选择呼叫

对讲机必须经过预设才能发起选择呼叫。按照步骤在对讲机上发起选择呼叫。

- 1 选择具有活动用户别名或 ID 的信道。

2 按 **PTT** 键发起呼叫。

LED 绿灯亮起。显示屏显示**单呼**图标、用户别名和呼叫状态。

3 执行以下操作之一：

- 等通话许可提示音结束后（启用该功能时）对着麦克风清楚地讲话。
 -  等 **PTT** 侧音结束后（启用该功能时）对着麦克风清楚地讲话。
-

4 释放 **PTT** 按钮接听。

当目标对讲机做出响应时，LED 绿灯亮起。

5 如果启用“信道空闲提示”功能，则当发射对讲机释放 **PTT** 时，您将会听到一声短的提示音，表示此信道空闲，您可以应答。按 **PTT** 来回复该呼叫。

在预定时间内无语音活动时，呼叫结束。

6 屏幕显示呼叫结束。

回复选择呼叫

按照步骤在对讲机上回复选择呼叫。

当您接收选择性呼叫时：

- LED 绿灯闪烁。
- 第一行文字显示**单呼**图标和呼叫方别名或选择性呼叫或语音呼叫提示。
- 对讲机取消静音，呼入电话会通过扬声器发出声音。

1 按 **PTT** 来回复该呼叫。

LED 绿灯亮起。

2 等通话许可提示音结束后（启用该功能时）对着麦克风清楚地讲话。

3 释放 **PTT** 按钮接听。

在预定时间内无语音活动时，呼叫结束。将发出一声提示音。屏幕显示呼叫结束。

电话呼叫

电话呼叫是从单个对讲机到电话的呼叫。

如果对讲机中未启用电话呼叫功能：

- 显示屏显示不可用。
- 对讲机会使呼叫静音。

- 呼叫结束时，对讲机将返回到前一屏幕。

在电话呼叫过程中，如果发生以下情况，对讲机将尝试结束呼叫：

- 在预配置取消接入代码的情况下，按**单键接入**按钮。
- 在输入额外数字时，输入取消接入代码。

在信道接入、摘机码或取消接入代码或其他数字传输期间，对讲机仅对**开/关**、**音量控制**和**信道选择器**按钮或旋钮作出响应。每次无效输入均会发出提示音。

在信道接入时，请按  取消呼叫尝试。将发出一声提示音。



说明：

摘机码或取消接入代码不可超过 10 个字符。

请联系您的经销商或系统管理员了解详情。

发出电话呼叫

按照以下过程操作，在对讲机上发出电话呼叫。

- 1 按预设的**单键接入**按钮显示预设的别名或 ID。

如果**单键接入**按钮的输入为空，将响起一声否定提示音。如果没有在通讯录列表中预配置摘机码，则显示屏显示摘机码：。

- 2 输入摘机码，然后按  继续。

摘机码或取消接入代码不可超过 10 个字符。

- 3 按 **PTT** 来回复该呼叫。释放 **PTT** 按钮接听。

- 4 如果呼叫要求，应使用键盘输入其他数字，然后按  继续。

如果在输入呼叫要求的其他数字时呼叫结束，对讲机返回至发起呼叫前的屏幕。

双音多频 (DTMF) 提示音响起。对讲机返回到前一屏幕。

- 5 按  以结束通话。

- 6 执行以下操作之一：

- 如果未预配置取消接入代码，则在显示屏显示取消接入代码：时输入取消接入代码，然后按  继续。对讲机返回到前一屏幕。
- 按预设的**单键接入**按钮。

如果**单键接入**按钮的输入为空，将响起一声否定提示音。

对讲机发出 DTMF 提示音，且屏幕显示正在结束通话。







如果呼叫成功结束：

- 将发出一声提示音。
- 屏幕显示呼叫结束。

如果呼叫无法结束，对讲机将返回到电话呼叫屏幕。重复后两个步骤或等待电话用户结束呼叫。

使用通讯录列表发出电话呼叫

按照步骤使用通讯录列表在对讲机上发出电话呼叫。



- 1 按  访问菜单。
- 2 按  或  显示通讯录。按  进行选择。
显示屏显示按字母顺序排列的条目。
- 3 按  或  显示所需的别名或 ID。按  进行选择。

处于“电话通讯录”屏幕上时，如果按 **PTT** 按钮：

- 屏幕第一行显示电话号：。
- 屏幕第二行显示闪烁的光标。

如果选定的条目为空：

- 发出一声否定提示音。
- 显示屏显示电话呼叫无效 #。

-
- 4 按  或  显示打电话。按  进行选择。
如果未预配置摘机码，显示屏显示摘机码：。

-
- 5 输入摘机码，然后按  继续。
摘机码或取消接入代码不可超过 10 个字符。
第一行文字显示正在呼叫。第二行文字显示用户别名或 ID 以及**电话呼叫**图标。
如果呼叫成功：
 - DTMF 提示音将响起。
 - 您将听到电话用户的拨号提示音。
 - 第一行文字显示用户别名或 ID 以及 **RSSI** 图标。
 - 第二行文字显示电话呼叫以及**电话呼叫**图标。

如果呼叫失败：

- 将发出一声提示音。
- 显示屏显示电话呼叫失败，然后显示摘机码：。
- 如果已在通讯录列表中预配置了摘机码，对讲机将返回到发起呼叫前您所在的屏幕。

6 按 **PTT** 来回复该呼叫。

RSSI 图标消失。

7 释放 **PTT** 按钮接听。

8 如果呼叫要求，应使用键盘输入其他数字，然后按

 继续。

如果在输入呼叫要求的其他数字时呼叫结束，对讲机将返回到发起呼叫前您所在的屏幕。

DTMF 提示音将响起。对讲机返回到前一屏幕。

9 按  以结束通话。

10 如果未预配置取消接入代码，则在显示屏显示取消接

入代码：时输入取消接入代码，然后按  继续。

对讲机返回到前一屏幕。对讲机发出 **DTMF** 提示音，且屏幕显示正在结束通话。

如果呼叫成功结束：

- 将发出一声提示音。
- 屏幕显示呼叫结束。

如果呼叫无法结束，对讲机将返回到电话呼叫屏幕。重复 [步骤 9](#) 和 [步骤 10](#)，或等待电话用户结束呼叫。

如果在电话通讯录屏幕中按 **PTT** 按钮，一声提示音响起，且屏幕显示按 **OK** 键发起呼叫。

当电话用户结束呼叫时，一声提示音响起，且屏幕显示通话结束。

如果在输入电话呼叫要求的其他数字时呼叫结束，对讲机返回至发起呼叫前的屏幕。



说明:

信道接入期间，按  可取消呼叫尝试并会发出一声提示音。



通话期间，在预配置取消接入代码的情况下按**单键接入按钮**时，或在输入取消接入代码作为其他数字的输入时，对讲机均会尝试结束通话。



在信道接入和接入代码/取消接入代码或其他数字传输期间，对讲机仅对**开/关按钮**、**音量旋钮**和**信道选择按钮**作出响应。每次无效输入均会发出提示音。



使用手动拨号发出电话呼叫

按照步骤使用手动拨号在对讲机上发出电话呼叫。

- 1 按  访问菜单。

- 2 按  或  显示通讯录。按  进行选择。

- 3 按  或  显示手动拨号。按  进行选择。

- 4 按  或  显示电话号。按  进行选择。
显示屏显示号码：和一个闪烁的光标。

- 5 输入电话号码，然后按  继续。
如果未预配置摘机码，显示屏显示摘机码：和一个闪烁的光标。

- 6 输入摘机码，然后按  继续。
摘机码或取消接入代码不可超过 10 个字符。

- 7 LED 绿灯亮起。显示屏右上角显示**电话呼叫**图标。第一行文字显示用户别名。第二行文字显示呼叫状态。
如果呼叫成功：
 - DTMF 提示音将响起。
 - 您将听到电话用户的拨号提示音。
 - 第一行文字显示用户别名。
 - 显示屏右上角继续显示**电话呼叫**图标。

如果呼叫失败：

- 将发出一声提示音。

- 显示屏显示电话呼叫失败，然后显示摘机码：。
- 如果已在通讯录列表中预配置了摘机码，对讲机将返回到发起呼叫前您所在的屏幕。

8 按 以结束通话。

9 执行以下操作之一：

- 如果未预配置取消接入代码，则在显示屏显示取消接入代码：时输入取消接入代码，然后按  继续。
对讲机返回到前一屏幕。
- 按预设的**单键接入**按钮。
如果**单键接入**按钮的输入为空，将响起一声否定提示音。

对讲机发出 DTMF 提示音，且屏幕显示正在结束通话。

如果呼叫成功结束：

- 将发出一声提示音。
- 屏幕显示呼叫结束。

如果呼叫无法结束，对讲机将返回到电话呼叫屏幕。
重复 **步骤 8** 或等待电话用户结束呼叫。



说明：

如果在“电话通讯录”屏幕中按 **PTT** 按钮，一声提示音响起，且显示屏显示按 **OK** 键发起呼叫。

电话用户结束通话时，会发出一声提示音且显示屏显示呼叫结束。

如果在输入电话呼叫要求的其他数字时呼叫结束，对讲机返回至发起呼叫前的屏幕。

信道接入期间，按  可取消呼叫尝试并会发出一声提示音。



通话期间，在预配置取消接入代码的情况下按**单键接入**按钮时，或在输入取消接入代码作为其他数字的输入时，对讲机均会尝试结束通话。



在信道接入和摘机码/取消接入代码或其他数字传输期间，对讲机仅对**开/关按钮**、**音量旋钮**和**信道选择按钮**作出响应。每次无效输入均会发出提示音。

通过别名搜索进行组呼、单呼、电话呼叫或全呼





按照步骤使用别名搜索发起呼叫。

- 1 按  访问菜单。

- 2 按  或  显示通讯录。按  进行选择。显示屏显示按字母顺序排列的条目。

- 3 按  或  至所需的用户别名或 ID。屏幕第一行显示电话号码：。屏幕第二行显示闪烁的光标。使用键盘输入电话号码。



- 4 按  进行选择。如果选择的条目为空，对讲机会发出一声否定提示音，且屏幕显示电话号码无效。

- 5 按  或  至“打电话”按  进行选择。，如果未在通讯录列表中预配置摘机码，则屏幕第一行显示摘机码：。屏幕第二行显示闪烁的光标。输入摘机码，然后按  按钮继续。如果成功，DTMF 提示音响起。您将听到电话用户的拨号提示音。屏幕第

一行显示用户别名或 ID 以及 RSSI 图标。屏幕第二行显示电话呼叫和“电话呼叫”图标。如果失败，将发出一声提示音，且屏幕显示打电话失败。对讲机返回到接入代码输入屏幕。如果在通讯录列表中预配置了接入代码，则对讲机会返回到您发起呼叫之前所在的屏幕。

- 6 按 **PTT** 按钮进行通话，释放可接听。RSSI 图标会在传输期间消失。



- 7 要输入其他数字（如果电话呼叫要求），执行以下操作之一。
 - 按任意键盘按键开始输入其他数字。屏幕第一行显示额外数字：。屏幕第二行显示闪烁的光标。输入其他数字，并按  按钮继续。对讲机将发出 DTMF 提示音，然后返回到前一屏幕。
 - 按**单键接入**按钮。DTMF 提示音将响起。如果**单键接入**按钮的输入为空，将响起一声否定提示音。

- 8 按  以结束通话。如果没有在通讯录列表中预配置取消接入代码，则屏幕第一行显示取消接入代码：。屏幕第二行显示闪烁的光标。输入取消接入代码，然后按  继续。对讲机返回到前一屏幕。对讲机发出 DTMF 提示音，且屏幕显示正在结束通话。

如果成功，将发出一声提示音，且屏幕显示通话结束。对讲机将返回到电话呼叫屏幕。如果失败，对讲机将返回到电话呼叫屏幕。如果在电话通讯录屏幕中按 **PTT** 按钮，一声提示音响起，且屏幕显示按 **OK** 键发起呼叫。当电话用户结束呼叫时，一声提示音响起，且屏幕显示通话结束。如果在输入电话呼叫要求的其他数字时呼叫结束，对讲机返回至发起呼叫前的屏幕。



说明：

信道接入期间，按  可取消呼叫尝试并会发出一声提示音，或退出别名搜索。按  或  退出别名搜索。通话期间，在预配置取消接入代码的情况下按 **单键接入** 按钮时，或在输入取消接入代码作为其他数字的输入时，对讲机均会尝试结束通话。在信道接入和摘机码/挂机码或外加数字传输期间，对讲机仅对开/关按钮、音量旋钮和信道选择按钮作出响应。每次无效输入均会发出提示音。



双音多频

双音多频 (DTMF) 功能使对讲机可以在与电话系统有接口连接的对讲机系统中工作。

您可以通过禁用所有对讲机提示音和提示来关闭 DTMF 提示音。有关详细信息，请参阅 [打开或关闭对讲机音调/提示 \(第 161 页\)](#)。

发起 DTMF 呼叫

按照步骤在对讲机上发起 DTMF 呼叫。

- 1 按住 **PTT** 按钮。
- 2 执行以下操作之一：
 - 输入所需号码发起 DTMF 呼叫。
 - 按  发起 DTMF 呼叫。
 - 按  发起 DTMF 呼叫。

回复组呼电话呼叫

按照步骤在对讲机上回复组呼电话呼叫。

当您收到组呼电话呼叫时：

- 显示屏右上角显示 **电话呼叫** 图标。
- 显示屏显示组别名和电话呼叫。

如果对讲机中未启用“电话”功能，则屏幕第一行会显示不可用，且对讲机会使呼叫静音。呼叫结束时，对讲机将返回到前一屏幕。

1 按 **PTT** 来回复该呼叫。释放 **PTT** 按钮接听。

2 按  以结束通话。

显示屏显示通话结束中。

如果呼叫成功结束：

- 将发出一声提示音。
- 屏幕显示呼叫结束。

如果呼叫无法结束，对讲机将返回到电话呼叫屏幕。
重复此步骤或等待电话用户结束呼叫。

回复全呼电话呼叫

当您收到全呼电话呼叫时，仅当全呼类型已分配至该信道时您才可回复或结束呼叫。按照步骤在对讲机上回复全呼电话呼叫。

当您收到全呼电话呼叫时：

- 显示屏右上角显示**电话呼叫**图标。
- 显示屏显示全呼和电话呼叫。

如果对讲机中未启用“电话”功能，则屏幕第一行会显示不可用，且对讲机会使呼叫静音。

呼叫结束时，对讲机将返回到前一屏幕。

1 按 **PTT** 来回复该呼叫。

2 释放 **PTT** 按钮接听。

3 按  以结束通话。

显示屏显示通话结束中。

如果呼叫成功结束：

- 将发出一声提示音。
- 显示屏显示全呼和呼叫结束。

如果呼叫无法结束，对讲机将返回到电话呼叫屏幕。
重复**步骤 3**或等待电话用户结束呼叫。

回复单呼电话呼叫

按照步骤在对讲机上回复单呼电话呼叫。

当您收到单呼电话呼叫时：

- 显示屏右上角显示**电话呼叫**图标。

- 显示屏显示呼叫方别名或电话呼叫。

如果对讲机中未启用“电话”功能，则屏幕第一行会显示不可用，且对讲机会使呼叫静音。呼叫结束时，对讲机将返回到前一屏幕。

1 按 **PTT** 来回复该呼叫。释放 **PTT** 按钮接听。

2 按  以结束通话。

显示屏显示通话结束中。

如果呼叫成功结束：

- 将发出一声提示音。
- 屏幕显示呼叫结束。

如果呼叫无法结束，对讲机将返回到电话呼叫屏幕。重复此步骤或等待电话用户结束呼叫。

停止对讲机呼叫

该功能允许您停止进行中的组呼或单呼，以便释放用于发射的信道。例如，当用户不慎按 **PTT** 按钮时，对讲机可能遇到“麦克风被占用”的情况。您的对讲机必须进行预设才允许您使用该功能。按照步骤在对讲机上中止呼叫。

1 按预设的**发射中断远程中断**按钮。

显示屏显示远程中断。

2 等待确认。

如果成功：

- 发出一声确定提示音。
- 显示屏显示远程中断成功。

如果失败：

- 发出一声否定提示音。
- 显示屏显示远程中断失败。



说明：

请联系您的经销商或系统管理员了解详情。

脱网

此功能使您可以在中继器不工作时或对讲机超出中继器范围但位于其他对讲机的通话范围内时继续通信。

即使在关机后，仍保持脱网设置。



说明:

此功能不适用于频率相同的“智能信道共享--单站点”、“智能信道共享--多站点”和民用频段信道。

在中继器和脱网模式之间切换

按照步骤在对讲机的中继器和脱网模式之间切换。

- 1 执行以下操作之一：
 - 按预设的**中继器/脱网**按钮。跳过以下步骤。
 - 按  访问菜单。

- 2 按  或  显示设置。按  进行选择。

- 3 按  或  显示对讲机设置。按  进行选择。

- 4 按  或  显示脱网。按  进行选择。
如果启用，已启用旁出现 。
如果禁用，已启用旁的  消失。
屏幕自动返回前一屏幕。

广播语音呼叫

广播语音呼叫是从任何用户到整个通话组的单向语音呼叫。

广播语音呼叫功能仅允许呼叫发起用户传输至通话组，而呼叫接收者无法响应（无呼叫闲置时间）。

您的对讲机必须进行预设才允许您使用该功能。请联系您的经销商或系统管理员了解详情。

发起广播语音呼叫

设置对讲机以发起广播语音呼叫。

- 1 选择具有活动通话组别名或 ID 的信道。

- 2 按 **PTT 键**发起呼叫。
LED 绿灯亮起。显示屏显示广播呼叫、**组呼**图标和别名。

- 3 执行以下操作之一：
 - 等通话许可提示音结束后（启用该功能时）对着麦克风清楚地讲话。
 - 等 **PTT** 侧音结束后（启用该功能时）对着麦克风清楚地讲话。

**说明:**

信道上的用户无法响应广播语音呼叫。

呼叫结束时，对讲机将返回到前一菜单。

使用可预设的数字键发起广播语音呼叫

按照步骤使用可预设的数字键在对讲机上发起广播语音呼叫。

- 1 在主屏幕上，长按分配给预定义别名或 ID 的预设数字键。

如果将数字键分配至特定模式下的一个条目，当您在另一种模式下长按此数字键时，将无法支持该功能。

如果该数字键未被分配至一个条目，您会听到一声否定提示音

- 2 按 **PTT 键**发起呼叫。
LED 绿灯亮起。

有关详细信息，请参阅[将条目分配至可编程数字键 \(第 327 页\)](#)。

使用别名搜索发起广播语音呼叫

按照该过程操作，使用别名搜索在对讲机上发起广播语音呼叫。

- 1 按 访问菜单。
- 2 按 或 显示通讯录。按 进行选择。
显示屏显示按字母顺序排列的条目。
- 3 按 或 至所需的用户别名或 ID。屏幕第一行显示电话号码：。屏幕第二行显示闪烁的光标。使用键盘输入电话号码。
- 4 按 进行选择。如果选择的条目为空，对讲机会发出一声否定提示音，且显示屏显示电话号码无效。
- 5 按 或 以“打电话”和按 进行选择。。如果未在通讯录列表中预配置摘机码，则屏幕第一行显示摘机码：。屏幕第二行显示闪烁的光标。
输入摘机码，然后按 按钮继续。如果成功，DTMF 提示音响起。您将听到电话用户的拨号提示

音。屏幕第一行显示用户别名或 ID 以及 RSSI 图标。屏幕第二行显示电话呼叫和“电话呼叫”图标。如果失败，将发出一声提示音，且屏幕显示打电话失败。对讲机返回到摘机码输入屏幕。如果在通讯录列表中预配置了摘机码，则对讲机会返回到您发起呼叫之前所在的屏幕。

6 按 **PTT** 按钮进行通话，释放可接听。RSSI 图标会在传输期间消失。

7 要输入外加数字（如果电话呼叫要求），请执行以下操作之一。

- 按任意键盘按键开始输入外加数字。屏幕第一行显示外加数字：。屏幕第二行显示闪烁的光标。输入外加数字，并按 **OK** 按钮继续。对讲机将发出 DTMF 提示音，然后返回到前一屏幕。
 - 按 **单键接入** 按钮。DTMF 提示音将响起。如果 **单键接入** 按钮的输入为空，将响起一声否定提示音。
-

8 按 **取消接入** 以结束通话。如果没有在通讯录列表中预配置取消接入代码，则屏幕第一行显示取消接入代码：。屏幕第二行显示闪烁的光标。输入取消接入代码，然后按 **OK** 继续。对讲机返回到前一屏幕。对讲机发出 DTMF 提示音，且屏幕显示正在结束通话。

如果成功，将发出一声提示音，且屏幕显示电话呼叫已结束。对讲机将返回到电话呼叫屏幕。如果失败，对讲机将返回到电话呼叫屏幕。如果在电话通讯录屏幕中按 **PTT** 按钮，一声提示音响起，且显示屏显示按 OK 键发起电话呼叫。当电话用户结束呼叫时，一声提示音响起，且屏幕显示通话结束。如果在输入电话呼叫要求的外加数字时呼叫结束，对讲机返回至发起呼叫前的屏幕。



说明：

信道接入期间，按 **取消接入** 可取消呼叫尝试并会发出一声提示音，或退出别名搜索。按 **OK** 按钮或 **取消接入** 退出别名搜索。在通话期间，在预配置取消接入代码的情况下按单键接入按钮时，或在输入取消接入代码作为外加数字的输入时，对讲机均会尝试结束通话。在信道接入和摘机码/取消接入代码或外加数字传输期间，对讲机仅对开/关按钮、音量旋钮和信道选择按钮作出响应。每次无效输入均会发出提示音。

接收广播语音呼叫

当您接收广播语音呼叫时：

- 将发出一声提示音。
- LED 绿灯闪烁。

- 显示屏右上角显示**组呼**图标。
- 第一行文字显示呼叫方别名 ID。
- 第二行文字显示广播呼叫。
- 对讲机取消静音，呼入电话会通过扬声器发出声音。

当呼叫结束时，对讲机会返回到前一屏幕。

广播呼叫不会等待预定义的时间，会直接终止。

您无法响应广播语音呼叫。



说明：

在接收广播呼叫时，如果您切换至另一个信道，则对讲机停止接收该站点全呼。您无法继续任何菜单导航或编辑，直至广播呼叫结束。

无地址呼叫

无地址呼叫是对 16 个预定义组 ID 的组呼。

此功能通过 CPS-RM 进行配置。需要一个预定义 ID 的联系人才能发起和/或接收无地址呼叫。请联系您的经销商或系统管理员了解详情。

发起无地址呼叫

- 1 选择具有活动通话组别名或 ID 的信道。

- 2 按 **PTT** 键发起呼叫。

LED 绿灯亮起。文本行显示无地址呼叫、**组呼**图标和别名。

- 3 执行以下操作之一：

- 等通话许可提示音结束后（启用该功能时）对着麦克风清楚地讲话。
- 等 **PTT** 侧音结束后（启用该功能时）对着麦克风清楚地讲话。

- 4 释放 **PTT** 按钮接听。

当目标对讲机做出响应时，LED 绿灯亮起。将发出一声瞬间音。显示屏显示无地址呼叫、**组呼**图标、别名或 ID，以及发射对讲机别名或 ID。

- 5 如果启用“信道空闲提示”功能，则当发射对讲机释放**通话按键**时，您将会听到一声短的提示音，表示此信道空闲，您可以应答。按 **PTT** 来回复该呼叫。

在预定时间内无语音活动时，呼叫结束。

呼叫发起者可按  以结束组呼。

响应无地址呼叫

当您接收到无地址呼叫时：

- LED 绿灯闪烁。
- 将发出一声瞬间音。
- 文本行显示无地址呼叫、呼叫方别名和组呼别名。
- 对讲机取消静音，呼入电话会通过扬声器发出声音。

1 执行以下操作之一：

- 如果启用“信道空闲提示”功能，则当发射对讲机释放 **PTT** 时，您将会听到一声短的提示音，表示此信道空闲，您可以应答。按 **PTT** 来回复该呼叫。
- 如果语音中断功能已启用，则按**通话按键**中止来自发射对讲机的音频，以释放信道供您做出应答。

LED 绿灯亮起。

2 执行以下操作之一：

- 等通话许可提示音结束后（启用该功能时）对着麦克风清楚地讲话。
- 等 **PTT** 侧音结束后（启用该功能时）对着麦克风清楚地讲话。

3 释放 **PTT** 按钮接听。

在预定时间内无语音活动时，呼叫结束。

开放语音信道模式 (OVCM)

在开放语音信道模式 (OVCM) 下，未预配置为在特定系统中工作的对讲机也可以进行个呼和组呼的接收和发送。

OVCM 组呼也支持广播呼叫。预设您的对讲机以使用此功能。请联系您的经销商或系统管理员了解详情。

发起 OVCM 呼叫

您的对讲机必须经过预设才能发起 OVCM 呼叫。按照以下过程操作，在对讲机上发起 OVCM 呼叫。

1 按 **PTT 键**发起呼叫。

LED 绿灯亮起。

文本行显示呼叫类型图标、OVCM 和别名。这表示对讲机已进入 OVCM 状态。

2 执行以下操作之一：

- 等通话许可提示音结束后（启用该功能时）对着麦克风清楚地讲话。

- 等 **PTT** 侧音结束后（启用该功能时）对着麦克风清楚地讲话。

- 等 **PTT** 侧音结束后（启用该功能时）对着麦克风清楚地讲话。

响应 OVCM 呼叫

当您接收 OVCM 呼叫时：

- LED 绿灯闪烁。
- 文本行显示呼叫类型图标、OVCM 和别名。
- 对讲机取消静音，呼入电话会通过扬声器发出声音。

1 执行以下操作之一：

- 如果启用“信道空闲提示”功能，则当发射对讲机释放 **PTT** 时，您将会听到一声短的提示音，表示此信道空闲，您可以应答。按 **PTT** 来回复该呼叫。
- 如果语音中断功能已启用，则按**通话按键**中止来自发射对讲机的音频，以释放信道供您做出应答。

LED 绿灯亮起。

2 执行以下操作之一：

- 等通话许可提示音结束后（启用该功能时）对着麦克风清楚地讲话。

3 释放 **PTT** 按钮接听。

在预定时间内无语音活动时，呼叫结束。

高级功能

本章介绍对讲机中可用的功能的操作。

您的经销商或系统管理员可能已经针对您的具体需要对对讲机进行了定制。请联系您的经销商或系统管理员了解详情。

主信道提醒

此功能在对讲机一段时间内未设置为主信道时提供一个提醒。

如果通过 **CPS** 启用了此功能，当对讲机一段时期内未设置为主信道时，将定期发生以下现象：

- 主信道提醒和提示音响起。
- 显示屏第一行显示无。
- 第二行显示主信道。

您可以通过执行以下操作之一回复提醒：

- 返回主信道。

- 使用可预设按钮使提醒暂时静音。
- 使用可预设按钮设置一个新主信道。

使主信道提醒静音

发出主信道提醒时，您可以暂时将提醒静音。



按**静音主信道提醒**预设按钮。



显示屏的第一行显示 HCR，第二行显示已设为静音。

设置新的主信道



发生主信道提醒时，您可以设置新的主信道。

- 1 执行以下操作之一：
 - 按**重置主信道**可预设按钮，以将当前信道设置为新的主信道。跳过以下步骤。
显示屏的第一行显示信道别名，第二行显示新主信道。
 - 按  访问菜单。

- 2 按  或  显示设置。按  进行选择。

- 3 按  或  显示对讲机设置。按  进行选择。

- 4 按  或  显示主信道。按  进行选择。

- 5 按  或  所需的新主信道别名。按  进行选择。

显示屏将在所选的主信道别名旁边显示 。



对讲机检测

此功能使您可以在不干扰对讲机用户的情况下，确定系统中的另一台对讲机是否为活动状态。无语音或可视通知出现在目标对讲机上。该功能仅对用户别名或 ID 适用。您的对讲机必须进行预设才允许您使用该功能。

发送对讲机检测

按照步骤在对讲机上发送对讲机检测。

- 1 按预设的**对讲机检测**按钮。

- 2 按  或  显示所需的别名或 ID。按  进行选择。

显示屏显示过渡性的小型通知，指示正在处理该请求。LED 绿灯亮起。

等待确认。

如果在等待确认时按 ，对讲机将发出一声提示音，终止所有重试并退出对讲机检测模式。

如果成功：

- 发出一声确定提示音。
- 显示屏显示确定性的小型通知。

如果失败：

- 发出一声否定提示音。
- 显示屏显示否定性的小型通知。



对讲机返回用户别名或 ID 屏幕。



使用手动拨号发送对讲机检测

按照步骤使用手动拨号在对讲机上发送对讲机检测。



- 1 按  访问菜单。



- 2 按  或  显示通讯录。按  进行选择。

- 3 按  或  显示手动拨号。按  进行选择。

- 4 按  或  显示对讲机号码。按  进行选择。

- 5 执行以下操作之一：

- 输入用户别名或 ID，然后按  继续。
- 编辑之前拨叫的 ID，然后按  继续。

- 6 按  或  显示对讲机检测。按  进行选择。

显示屏显示过渡性的小型通知，指示正在处理该请求。LED 绿灯亮起。

- 7 等待确认。

如果在对讲机等待确认时按 ，对讲机会发出一声提示音，终止所有重试，并退出对讲机检测模式。

如果成功：

- 发出一声确定提示音。
- 显示屏显示确定性的小型通知。

如果失败：

- 发出一声否定提示音。
- 显示屏显示否定性的小型通知。

对讲机返回用户别名或 ID 屏幕。

远程监听

此功能用于打开具有用户别名或 ID 的目标对讲机的麦克风。您可以使用该功能远程监听目标对讲机四周的任何声音活动。

有两种类型的远程监听：

- 无身份验证的远程监听
- 带身份验证的远程监听。

带身份验证的远程监听是一项可购买功能。在身份验证远程监听中，当对讲机打开目标对讲机的麦克风时，需要验证。

当您的对讲机利用用户身份验证在目标对讲机上发起此功能时，需要口令。该口令通过 CPS 预设到目标对讲机中。

您的对讲机和目标对讲机必须进行预设才允许您使用该功能。

在预设的持续时间后或者当目标对讲机上执行了任何用户操作时，该功能将停止。

开始远程监听

按照步骤在对讲机上启动远程监听。

1 按预设的**远程监听**按钮。

2 按  或  显示所需的别名或 ID。

3 按  进行选择。会发生以下情况之一：

- 显示屏显示过渡性的小型通知，指示正在处理该请求。LED 绿灯亮起。
- 出现口令屏幕。

输入口令。按  继续。

- 如果口令正确，显示屏显示过渡性的小型通知，指示正在处理该请求。LED 绿灯亮起。

- 如果口令错误，显示屏将显示否定性的小型通知，并返回上一个屏幕。

4 等待确认。

如果成功：

- 发出一声确定提示音。
- 显示屏显示确定性的小型通知。
- 开始在预设持续时间内播放来自被监听对讲机的音频，并且显示屏显示远程监听。计时器超时后，对讲机发出一声提示音，且 LED 指示灯熄灭。



如果失败：



- 发出一声否定提示音。
- 显示屏显示否定性的小型通知。

使用通讯录列表启动远程监听

按照步骤使用通讯录列表在对讲机上启动远程监听。

1 按  访问菜单。

2 按  或  显示通讯录。按  进行选择。

3 按  或  显示所需的别名或 ID。按  进行选择。

4 按  或  显示远程监听。

5 按  进行选择。会发生以下情况之一：

- 显示屏显示过渡性的小型通知，指示正在处理该请求。LED 绿灯亮起。
- 出现口令屏幕。

输入口令。按  继续。

- 如果口令正确，显示屏显示过渡性的小型通知，指示正在处理该请求。LED 绿灯亮起。
- 如果口令错误，显示屏将显示否定性的小型通知，并返回上一个屏幕。

6 等待确认。



如果成功：

- 发出一声确定提示音。
- 显示屏显示确定性的小型通知。

- 开始在预设持续时间内播放来自被监听对讲机的音频，并且显示屏显示远程监听。计时器超时后，对讲机发出一声提示音，且 LED 指示灯熄灭。

如果失败：

- 发出一声否定提示音。
- 显示屏显示否定性的小型通知。

- 输入用户别名或 ID，然后按  继续。
- 编辑之前拨叫的 ID，然后按  继续。

使用手动拨号启动远程监听

按照步骤使用手动拨号在对讲机上启动远程监听。

- 1 按  访问菜单。
- 2 按  或  显示通讯录。按  进行选择。
- 3 按  或  显示手动拨号。按  进行选择。
- 4 按  或  显示对讲机号码。按  进行选择。
- 5 执行以下操作之一：

6 按  或  显示远程监听。

7 按  进行选择。会发生以下情况之一：

- 显示屏显示过渡性的小型通知，指示正在处理该请求。LED 绿灯亮起。
- 出现口令屏幕。

输入口令。按  继续。

- 如果口令正确，显示屏显示过渡性的小型通知，指示正在处理该请求。LED 绿灯亮起。
- 如果口令错误，显示屏将显示否定性的小型通知，并返回上一个屏幕。

8 等待确认。

如果成功：

- 发出一声确定提示音。
- 显示屏显示确定性的小型通知。

- 开始在预设持续时间内播放来自被监听对讲机的音频，并且显示屏显示远程监听。计时器超时后，对讲机发出一声提示音，且 LED 指示灯熄灭。

如果失败：

- 发出一声否定提示音。
- 显示屏显示否定性的小型通知。

列表中，不能有多于一个优先级 1 或优先级 2 信道。如果优先级设置为无，则不会显示**优先级**图标。



说明：

此功能在智能信道共享中不适用。

查看扫描列表中的条目

按照步骤查看对讲机扫描列表中的条目。

- 按  访问菜单。
- 按  或  显示扫描。按  进行选择。
- 按  或  显示扫描列表。按  进行选择。
- 按  或  查看列表上的各个成员。

扫描列表

创建扫描列表并分配给单个信道或通话组。通过循环扫描列表中的指定信道或通话组序列以查找当前信道或通话组，对讲机可扫描是否有语音活动。

您的对讲机可支持最多 250 个扫描列表，每个列表最多 16 个成员。

每个扫描列表支持模拟和数字条目的混合。

您可以通过编辑扫描列表来添加、删除信道或为信道排定优先级。

您可以使用前面板预设将新的扫描列表加入您的对讲机。有关详细信息，请参阅[前面板配置 \(第 151 页\)](#)。

如果设定了优先级，则**优先级**图标显示在成员别名左侧，指示该成员位于优先级 1 还是优先级 2 信道列表。在一个扫描

使用别名搜索查看扫描列表中的条目

按照步骤使用别名搜索查看对讲机扫描列表中的条目。

- 1 按  访问菜单。

- 2 按  或  显示扫描。按  进行选择。

- 3 按  或  显示扫描列表。按  进行选择。

- 4 输入所需别名的第一个字符。
显示屏显示一个闪烁的光标。

- 5 输入所需别名的其余字符。
别名搜索不区分大小写。如果有两个或两个以上名称相同的条目，对讲机将显示列表中首先列出的条目。
第一行文字显示您输入的字符。接下来的几行文字显示筛选后的搜索结果。

向扫描列表添加新条目

按照步骤向对讲机上的扫描列表添加新条目。

- 1 按  访问菜单。

- 2 按  或  显示扫描。按  进行选择。







- 3 按  或  显示扫描列表。按  进行选择。

- 4 按  或  显示添加扫描信道。按  进行选择。

- 5 按  或  显示所需的别名或 ID。按  进行选择。

- 6 按  或  显示所需的优先级。按  进行选择。
显示屏显示确定性的小型通知，然后显示继续添加？。



7 执行以下操作之一：



- 按  或  显示是，以添加其他条目。按  进行选择。重复步骤 5 和步骤 6。
- 按  或  显示否，以保存当前列表。按  进行选择。



使用别名搜索向扫描列表添加新条目

按照步骤使用别名搜索向对讲机上的扫描列表添加新条目。

1 按  访问菜单。

2 按  或  显示扫描。按  进行选择。

3 按  或  显示扫描列表。按  进行选择。

4 按  或  显示添加扫描信道。按  进行选择。

5 输入所需别名的第一个字符。



显示屏显示一个闪烁的光标。

6 输入所需别名的其余字符。

别名搜索不区分大小写。如果有两个或两个以上名称相同的条目，对讲机将显示列表中首先列出的条目。



第一行文字显示您输入的字符。接下来的几行文字显示筛选后的搜索结果。



7 按  进行选择。

8 按  或  显示所需的优先级。按  进行选择。

显示屏显示确定性的小型通知，然后显示继续添加？。

9 执行以下操作之一：







- 按  或  显示是，以添加其他条目。按  进行选择。重复步骤 步骤 5 至步骤 步骤 8。

- 按  或  显示否，以保存当前列表。按  进行选择。
-

删除扫描列表中的条目

按照步骤删除扫描列表中的条目。

- 按  访问菜单。
- 按  或  显示扫描。按  进行选择。
- 按  或  显示扫描列表。按  进行选择。
- 按  或  显示所需的别名或 ID。按  进行选择。
- 按  或  显示删除。按  进行选择。
显示屏显示删除条目？。
- 执行以下操作之一：







- 按  或  显示是以删除该条目。按  进行选择。
显示屏显示确定性的小型通知。
 - 按  或  显示否以返回前一屏幕。按  进行选择。
-



- 重复步骤 [步骤 4](#) 至 [步骤 6](#) 删除其他条目。
-



- 删除所需的所有别名或 ID 后，长按  返回主屏幕。
-



设置扫描列表中条目的优先级

按照步骤设置对讲机扫描列表中条目的优先级。

- 按  访问菜单。
 - 按  或  显示扫描。按  进行选择。
 - 按  或  显示扫描列表。按  进行选择。
-

4 按  或  显示所需的别名或 ID。按  进行选择。

5 按  或  显示编辑优先级。按  进行选择。

6 按  或  显示所需的优先级。按  进行选择。

在返回前一屏幕前，显示屏显示确定性的小型通知。
优先级图标将出现在成员别名的左侧。

扫描

在启动扫描时，对讲机循环当前信道的预设扫描列表来查看是否有语音活动。



说明：

此功能在智能信道共享中不适用。

在双模扫描期间，如果您位于一个数字信道上，而您的对讲机锁定一个模拟信道，将在该呼叫的整个持续时间内自动由数字模式切换为模拟模式。反之亦然。

有两种方法启动扫描：

主信道扫描（手动）

对讲机可扫描您的扫描列表中的所有信道或通话组。在进入扫描时，根据设置不同，对讲机可自动从最后一个被扫描的活动信道或通话组开始或从开启扫描的信道开始。

自动扫描（自动）

当您选择一个已经激活自动扫描的信道或通话组时，对讲机自动开始扫描。







说明：



当您配置**扫描时接收组信息**时，您的对讲机能够从非主信道接收组信息。您的对讲机能够在主信道回复组信息，但不能在非主信道回复。请联系您的经销商或系统管理员了解详情。



开启或关闭扫描

按照步骤开启或关闭对讲机上的扫描。

1 按  访问菜单。

2 按  或  显示扫描。按  进行选择。

3 按  或  显示扫描状态。按  进行选择。

- 按  或  访问所需的扫描状态，然后按  进行选择。

如果扫描已启用：

- 显示屏显示扫描开和**扫描**图标。
- 黄色 LED 指示灯闪烁。

如果扫描被禁用：

- 显示屏显示扫描关。
- 扫描**图标消失。
- LED 熄灭。

在扫描期间对发射做出响应

在扫描过程中，若检测到活动的信道或通话组，对讲机将停止。对讲机在预设的时限内保持在该信道，该时限被称为“闲置时间”。按照步骤在扫描期间对发射做出响应。

-  如果启用“信道空闲提示”功能，则当发射对讲机释放 **PTT** 时，您将会听到一声短的提示音，表示此信道空闲，您可以应答。在闲置时间内，按**通话按键**。LED 绿灯亮起。

- 释放 **PTT** 按钮接听。

如果在闲置时间内未做出响应，对讲机将返回以扫描其他信道或通话组。

删除无用信道

如果某个信道连续出现无用呼叫或噪声（称为“无用”信道），您可以暂时将无用信道从扫描列表中删除。该功能不适用于指定为所选信道的信道。按照步骤删除对讲机上的无用信道。

- 当对讲机“锁住”一个无用信道时，按预设的**无用信道删除**按钮，直到您听到一声提示音。
- 释放预设的**无用信道删除**按钮。

无用信道被删除。

恢复无用信道

按照步骤在对讲机上恢复无用信道。

执行以下操作之一：

- 关闭并重新打开对讲机。

- 使用预设的**扫描**按钮或菜单停止并重启扫描。
- 使用**信道上调/下调**按钮更改信道。

投票扫描

如果某个区域具备多个在不同模拟信道发射相同信息的基站，投票扫描可以为您提供较大的覆盖范围。

您的对讲机将扫描多个基站的模拟信道，然后执行投票过程，以选择最强的接收信号。选择了最强的信号后，您的对讲机将接收来自该基站的发射信号。

投票扫描期间，黄色 LED 指示灯闪烁且显示屏显示**投票扫描**图标。

投票扫描期间，按照与**在扫描期间对发射做出响应 (第 324 页)**相同的步骤操作以响应传输。

通讯录设置

对讲机上的通讯录提供地址簿功能。每个条目对应于一个用于启动呼叫的别名或 ID。条目按字母顺序排列。

根据上下文的不同，每个条目都会关联不同的呼叫类型：组呼、单呼、全呼、PC 呼叫或调度呼叫。

PC 呼叫和调度呼叫是与数据相关的。这两种呼叫只能与数据应用一起使用。有关详细信息，请参阅数据应用文档。

 另外，通讯录菜单允许您将每个条目分配至键盘麦克风上一个或多个可预设数字键。如果在数字键上分配一个条目，您的对讲机可据此进行快速呼叫。



说明：

您会在每个被分配至某个条目的数字按钮之前看到一个复选标记。如果复选标记位于空置之前，则说明您未对该条目分配一个数字键。

通讯录中的每个条目会显示以下信息：

- 呼叫类型
- 呼叫别名
- 呼叫 ID







说明：



如果启用了某个信道上的加密功能，您就可以在此信道上发起加密组呼、单呼 and 全呼。只有当目标对讲机和您的对讲机拥有相同的加密密钥或相同的密钥值和密钥 ID 时，才能对发射信号进行解密。

使用通讯录列表发起组呼

按照步骤使用通讯录列表在对讲机上发起组呼。

- 1 按  访问菜单。

2 按  或  显示通讯录。按  进行选择。

3 按  或  显示所需的别名或 ID。按  进行选择。

4 按 **PTT 键**发起呼叫。
LED 绿灯亮起。



5 释放 **PTT** 按钮接听。
当组内任何用户回复时，LED 绿灯闪烁。显示屏显示 **组呼**图标、别名或 ID，以及发射对讲机别名或 ID。



6  如果启用“信道空闲提示”功能，则当发射对讲机释放 **PTT** 时，您将会听到一声短的提示音，表示此信道空闲，您可以应答。按 **PTT** 来回复该呼叫。
在预定时间内无语音活动时，呼叫结束。

使用通讯录列表发起单呼

按照步骤使用通讯录列表在对讲机上发起单呼。

1 按  访问菜单。

2 按  或  显示通讯录。按  进行选择。

3 按  或  显示所需的别名或 ID。按  进行选择。

4 按 **PTT 键**发起呼叫。
LED 绿灯亮起。 屏幕显示目标别名。

5 等通话许可提示音结束后（启用该功能时）对着麦克风清楚地讲话。



6 释放 **PTT** 按钮接听。
当目标对讲机做出响应时，LED 绿灯闪烁。 显示屏显示发送用户别名或 ID。



7  如果启用“信道空闲提示”功能，则当发射对讲机释放 **PTT** 时，您将会听到一声短的提示音，表示此信道空闲，您可以应答。按 **PTT** 来回复该呼叫。
在预定时间内无语音活动时，呼叫结束。将发出一声提示音。 屏幕显示呼叫结束。



将条目分配至可编程数字键







按照步骤将条目分配至对讲机上的可编程数字键。

- 1 按  访问菜单。



- 2 按  或  显示通讯录。按  进行选择。



- 3 按  或  显示所需的别名或 ID。按  进行选择。

- 4 按  或  显示快捷键配置。按  进行选择。

- 5 执行以下操作之一：
 - 如果未将所需的数字键分配到一个条目，按  或  显示所需的数字键。按  进行选择。
 - 如果已将所需的数字键分配到一个条目，显示屏显示当前键已被指定，然后第一行文本显示是否覆盖？。执行以下操作之一：
按  或  显示是。按  进行选择。

对讲机发出一声确定提示音，显示屏显示联系人已保存和确定性的小型通知。

按  或  显示否以返回上一步。

每个条目可以与不同的数字键相关联。您会在每个被分配至某个条目的数字键之前看到一个 。如果  在空置之前，表示该数字键未分配。



如果将数字键分配至特定模式下的一个条目，当您在另一种模式下长按此数字键时，将无法支持该功能。



屏幕自动返回上一级菜单。



删除条目和可编程数字键之间的关联



按照步骤在对讲机上删除条目和可编程数字键之间的关联。



- 1 执行以下操作之一：
 - 长按预设的数字键显示所需的别名或 ID。继续 [步骤 4](#)。
 - 按  访问菜单。

- 2 按  或  显示通讯录。按  进行选择。

3 按  或  显示所需的别名或 ID。按  进行选择。

4 按  或  显示快捷键配置。按  进行选择。

5 按  或  显示空。按  进行选择。
第一行文字显示从所有按钮中清除。

6 按  或  显示是。按  进行选择。



说明:



当条目被删除时，该条目与其预设数字键之间的关联将被取消。



发出一声确定提示音。显示屏显示联系人已保存。
屏幕自动返回上一级菜单。

添加新联系人

按照步骤在对讲机上添加新联系人。

1 按  访问菜单。



2 按  或  显示通讯录。按  进行选择。

3 按  或  显示新建联系人。按  进行选择。

4 按  或  以选择联系人类型对讲机联系人或电话联系人。按  进行选择。

5 用键盘输入联系人号码，然后按  继续。

6 用键盘输入联系人姓名，然后按  继续。

7 按  或  显示所需的铃声类型。按  进行选择。

发出一声确定提示音。显示屏显示确定性的小型通知。

设置默认联系人

按照步骤在对讲机上设置默认联系人。

- 1 按  访问菜单。

- 2 按  或  显示通讯录。按  进行选择。

- 3 按  或  显示所需的别名或 ID。按  进行选择。

- 4 按  或  显示设为默认值。按  进行选择。

发出一声确定提示音。显示屏显示确定性的小型通知。显示屏在所选的默认别名或 ID 旁边显示 。

呼叫提醒设置

此功能允许对讲机用户配置呼叫或短信铃声。

激活或停用呼叫提示的呼叫铃声

按照步骤在对讲机上激活或停用呼叫提示的呼叫铃声。

- 1 按  访问菜单。

- 2 按  或  显示设置。按  进行选择。

- 3 按  或  显示对讲机设置。按  进行选择。

- 4 按  或  显示音调/提示。按  进行选择。

- 5 按  或  显示呼叫铃声。按  进行选择。



- 6 按  或  显示呼叫提示。按  进行选择。

- 7 按  或  显示所需的提示音。按  进行选择。显示屏在所选提示音旁边显示 。

激活或停用单呼呼叫铃声

按照步骤在对讲机上激活或停用单呼呼叫铃声。













- 1 按  访问菜单。
- 2 按  或  显示设置。按  进行选择。
- 3 按  或  显示对讲机设置。按  进行选择。
- 4 按  或  显示音调/提示。按  进行选择。
- 5 按  或  显示呼叫铃声。按  进行选择。
- 6 按  或  显示单呼。按  进行选择。
如果启用单呼的呼叫铃声，显示屏在开旁边显示 。
如果禁用单呼的呼叫铃声，显示屏在关旁边显示 .



- 7 按  或  显示所需的提示音。按  进行选择。

如果启用，已启用旁出现 。如果禁用，已启用旁的  消失。





激活或停用选择呼叫的呼叫铃声

按照步骤在对讲机上激活或停用选择呼叫的呼叫铃声。

- 1 按  访问菜单。
- 2 按  或  显示设置。按  进行选择。
- 3 按  或  显示对讲机设置。按  进行选择。
- 4 按  或  显示音调/提示。按  进行选择。
- 5 按  或  显示呼叫铃声。按  进行选择。

- 6 按  或  显示选择呼叫。按  进行选择。



显示屏显示  和当前提示音。



- 7 按  或  显示所需的提示音。按  进行选择。显示屏在所选提示音旁边显示 。



激活或停用短信呼叫铃声



按照步骤在对讲机上激活或停用短信呼叫铃声。





- 1 按  访问菜单。





- 2 按  或  显示设置。按  进行选择。

- 3 按  或  显示对讲机设置。按  进行选择。

- 4 按  或  显示音调/提示。按  进行选择。

- 5 按  或  显示呼叫铃声。按  进行选择。



- 6 按  或  显示短信。按  进行选择。显示屏显示  和当前提示音。



- 7 按  或  显示所需的提示音。按  进行选择。显示屏在新选提示音旁边显示 。



激活或停用带文本的遥感遥测状态的呼叫铃声



按照步骤在对讲机上激活或停用带文本的遥感遥测状态的呼叫铃声。





- 1 按  访问菜单。

- 2 按  或  显示设置。按  进行选择。

3 按  或  显示对讲机设置。按  进行选择。

4 按  或  显示音调/提示。按  进行选择。



5 按  或  显示呼叫铃声。按  进行选择。



6 按  或  显示遥感遥测。按  进行选择。
当前提示音以  表示。

指定铃音类型



接收特定联系人的单呼、呼叫提示或短信时，可以将对讲机设置为发出 11 种预定义铃音中的任何一种。当您浏览该列表时，对讲机播放各铃音类型的声音。按照步骤在对讲机上指定铃音类型。





1 按  访问菜单。

2 按  或  显示通讯录。按  进行选择。
条目按字母顺序排列。

3 按  或  显示所需的别名或 ID。按  进行选择。

4 按  或  显示查看/编辑。按  进行选择。

5 按 ，直到显示屏显示铃声菜单
一个  指示当前所选提示音。

6 按  或  显示所需的提示音。按  进行选择。
 所选提示音旁边会出现。

渐强警报音

对讲机可预设为当对讲机呼叫尚未回复时，不断提醒。这由警报音量随时间自动增强来实现。此功能称为渐强提示音。

呼叫记录功能





您的对讲机将记录所有近期的已拨呼叫、已接来电和未接单呼。使用呼叫记录功能查看和管理近期的呼叫。

“未接呼叫提示”可能包括在呼叫记录中，具体取决于对讲机上的系统配置。您可以在各呼叫列表中执行以下任务：

- 将别名或 ID 存储至通讯录
- 删除呼叫
- 删除所有呼叫
- 查看详情

查看最近呼叫

按照步骤在对讲机上查看最近呼叫。

- 1 按  访问菜单。
- 2 按  或  显示呼叫记录。按  进行选择。
- 3 按  或  显示首选列表。选项为未接呼叫、已接呼叫和已拨呼叫列表。

按  进行选择。





显示屏显示最近期的条目。

- 4 按  或  查看列表。



您可以按 **PTT** 按钮使用显示屏当前显示的别名或 ID 发起呼叫。



删除呼叫列表中的呼叫

按照步骤删除呼叫列表中的呼叫。





- 1 按  访问菜单。
- 2 按  或  显示呼叫记录。按  进行选择。
- 3 按  或  显示所需的列表。按  进行选择。
如果列表为空：
 - 将发出一声提示音。

- 显示屏显示列表为空。

4 按  或  显示所需的别名或 ID。按  进行选择。

5 按  或  显示删除条目？。按  进行选择。



6 执行以下操作之一：



- 按  选择是以删除该条目。
屏幕显示条目已删除。
- 按  或  显示否。按  进行选择。
对讲机返回到前一屏幕。



查看呼叫列表详情



按照步骤在对讲机上查看呼叫详情。

1 按  访问菜单。

2 按  或  显示呼叫记录。按  进行选择。

3 按  或  显示所需的列表。按  进行选择。



4 按  或  显示所需的别名或 ID。按  进行选择。



5 按  或  显示查看详情。按  进行选择。
显示屏显示呼叫详情。



从呼叫列表存储别名或 ID



按照步骤从对讲机呼叫列表存储别名或 ID。

1 按  访问菜单。

2 按  或  显示呼叫记录。按  进行选择。

3 按  或  显示所需的列表。按  进行选择。

4 按  或  显示所需的别名或 ID。按  进行选择。

5 按  或  显示存储。按  进行选择。
显示屏显示一个闪烁的光标。

6 输入所需别名的其余字符。按  进行选择。
您可以存储无别名的 ID。
显示屏显示确定性的小型通知。

呼叫提醒操作

呼叫提示使您可以提示一个具体的对讲机用户回呼您。

该功能仅适用于用户别名或 ID，并且可从菜单中使用通讯录、手动拨号或预设的**单键接入**按钮来访问。

发起呼叫提示

按照步骤在对讲机上发起呼叫提示。

1 按预设的**单键接入**按钮。

显示屏显示呼叫提示及用户别名或 ID。LED 绿灯亮起。

2 等待确认。

如果接收到呼叫提示确认，显示屏会显示确定性的小型通知。



如果未收到呼叫提示确认，显示屏会显示否定性的小型通知。



使用通讯录列表发起呼叫提示

按照步骤使用通讯录列表在对讲机上发起呼叫提示。

1 按  访问菜单。

2 按  或  显示通讯录。按  进行选择。

3 按  或  显示所需的别名或 ID。按  进行选择。

4 按  或  显示呼叫提示。按  进行选择。

显示屏显示呼叫提示及用户别名或 ID。LED 绿灯亮起。

5 等待确认。



- 如果接收到呼叫提示确认，显示屏会显示确定性的小型通知。
 - 如果未收到呼叫提示确认，显示屏会显示否定性的小型通知。
-

使用手动拨号发起呼叫提示

按照步骤使用手动拨号在对讲机上发起呼叫提示。



1 按  访问菜单。

2 按  或  显示通讯录。按  进行选择。

3 按  或  显示手动拨号。按  进行选择。

显示屏显示一个闪烁的光标。

4 输入用户 ID，然后按  继续。

5 按  或  显示呼叫提示。按  进行选择。

显示屏显示呼叫提示及用户别名或 ID。LED 绿灯亮起。

6 等待确认。

- 如果接收到呼叫提示确认，显示屏会显示确定性的小型通知。
 - 如果未收到呼叫提示确认，显示屏会显示否定性的小型通知。
-

对呼叫提示做出响应

按照步骤在对讲机上对呼叫提示做出响应。

当您接收呼叫提示时：

- 将发出一声重复音。
- 黄色 LED 指示灯闪烁。
- 显示屏显示出呼叫提示以及主叫对讲机别名或 ID 的通知列表。

您可以通过执行以下操作之一响应呼叫提示，具体取决于经销商或系统管理员的配置：

- 按 **PTT** 按钮并通过单呼直接回复呼叫方。
- 按 **PTT** 按钮继续进行正常的通话组通信。“呼叫提示”被移至“呼叫记录”菜单的“未接来电”选项。您可以从“未接来电记录”响应呼叫方。

有关详细信息，请参阅[通知列表 \(第 149 页\)](#)和[呼叫记录功能 \(第 99 页\)](#)。

静音模式

静音模式将为用户提供静音对讲机所有音频指示器的选项。

启用静音模式功能后，所有音频指示器都将静音，优先级更高的功能除外（如紧急呼叫操作）。

退出静音模式后，对讲机将恢复播放正在进行的提示音并恢复音频传输。



说明：

这是一项可购买功能。请联系您的经销商或系统管理员了解详情。

打开静音模式

按照以下步骤打开静音模式。

使用预设的**静音模式**按钮访问此功能。

启用静音模式时，将发生以下情况：

- 发出一声确定提示音。
- 显示屏将显示静音模式开。
- 红色 LED 灯开始闪烁，直至退出静音模式。
- 显示屏主屏幕上显示**静音模式**图标。
- 对讲机处于静音状态。
- 静音模式计时器开始倒数配置的持续时间。

设置静音模式计时器

可通过设置静音模式计时器在预配置的时间内启用静音模式功能。该计时器持续时间在对讲机菜单中配置，可设范围介于 0.5 至 6 小时。计时器到时后将退出静音模式。

如果计时器停留在 0 处，则对讲机将在无限期的时间段内保持静音模式，直至按预设的**静音模式**按钮。

- 1 按  访问菜单。
- 2 按  或  显示设置。按  进行选择。
- 3 按  或  显示对讲机设置。按  进行选择。
- 4 按  或  显示静音计时器。按  进行选择。
- 5 按  或  编辑每个数位的数值，然后按下 。

退出静音模式

静音计时器到时后，此功能会自动退出。

执行以下任一操作手动退出静音模式：

- 按预设的**静音模式**按钮。
- 按任何条目上的 **PTT** 按钮。

禁用静音模式时，将发生以下情况：

- 发出一声否定提示音。
- 显示屏将显示静音模式关。
- 闪烁的红色 LED 指示灯关闭。
- **静音模式**图标将从主屏幕上消失。
- 您的对讲机将取消静音并恢复扬声器状态。
- 如果计时器未到时，则静音模式计时器将被暂停。



说明：

如果用户传输语音或切换至未预设的信道，则将退出静音模式。

紧急操作

紧急警报用于表示紧急情况。您可以在任何时候，甚至在当前信道上活动的情况下，发起紧急呼叫。

您的经销商可以设置预设**紧急呼叫**按钮的按下持续时间（除了长按，长按的持续时间与所有其他按钮类似）：

短按

持续时间介于 0.05 秒至 0.75 秒之间。

长按

持续时间介于 1.00 秒到 3.75 秒之间。

紧急呼叫按钮设有紧急呼叫开/关功能。有关**紧急呼叫**按钮所设置的操作功能，请联系您的经销商。



说明：

如果短按**紧急呼叫**按钮发起紧急模式，则长按相同按钮将让对讲机可退出紧急模式。

如果长按**紧急呼叫**按钮发起紧急模式，则短按相同按钮将让对讲机可退出紧急模式。

您的对讲机支持三种紧急报警：

- 紧急警报
- 带呼叫的紧急警报
- 带语音跟随的紧急警报 



说明：

仅可将上述紧急警报中的一种分配给预设的**紧急呼叫**按钮或紧急呼叫脚踏开关。

此外，每种警报有以下类型：

常规

对讲机发送警报信号并显示语音和/或视觉提示。

静音

对讲机发送警报信号，无任何语音或视觉提示。对讲机接收不通过扬声器发出提示音的呼叫，直到预设的**紧急麦克风**传输周期结束，并且/或者按 **PTT** 按钮。

带话音的静音

对讲机发送没有任何语音或视觉指示的警报信号，但允许呼入电话通过扬声器发出声音。

接收紧急警报



按照步骤在对讲机上接收紧急警报。

当您收到紧急警报时：

- 将发出一声提示音。
- 红色 LED 闪烁。

- 显示屏显示**紧急呼叫**图标和紧急呼叫方别名，或如果存在多个警报，警报列表中显示所有紧急呼叫方别名。

1 执行以下操作之一：

- 如果只有一个警报，按  以查看更多详细信息。
- 如果有多个警报，按  或  以显示所需的别名，然后按  以查看更多详细信息。

2 按 以查看操作选项。

3 按 并选择是以退出警报列表。

4 按 访问菜单。

5 选择警报列表以重新访问警报列表。

- ### 6 将发出提示音，并且红色 LED 闪烁，直到您退出紧急模式。但是，可将提示音关闭。执行以下操作之一：
- 按 **PTT** 按钮以呼叫收到紧急警报的对讲机组。

- 按下任何预设按钮。
- 退出紧急模式。请参阅[接收紧急报警后退出紧急呼叫模式 \(第 341 页\)](#)。

对紧急警报做出响应

按照步骤在对讲机上对紧急警报做出响应。

- ### 1 确保屏幕显示警报列表。按 或 显示所需的别名或 ID。

- ### 2 如果启用“信道空闲提示”功能，则当发射对讲机释放 **PTT** 时，您将会听到一声短的提示音，表示此信道空闲，您可以应答。按**通话按键**可以向作为紧急警报目标的同一个通话组发送非紧急语音信号。

LED 绿灯亮起。您的对讲机会保持在紧急呼叫模式。

- ### 3 执行以下操作之一：
- 等通话许可提示音结束后（启用该功能时）对着麦克风清楚地讲话。
 -  等 **PTT** 侧音结束后（启用该功能时）对着麦克风清楚地讲话。

4 释放 PTT 按钮接听。

发起紧急呼叫的对讲机作出响应时：

- LED 绿灯闪烁。
- 显示屏显示**组呼**图标和 ID、发射对讲机 ID 和警报列表。

只有发起紧急呼叫的对讲机才能发送紧急语音信号，所有其他对讲机（包括接收紧急呼叫的对讲机）只可以发送非紧急语音信号。

接收紧急报警后退出紧急呼叫模式

执行以下操作以在接收紧急警报后退出紧急模式：

- 删除警报项目。
- 关闭对讲机。

发送紧急警报

该功能允许您发送非语音的紧急警报信号，它可以启动一组对讲机上的警报指示。当设置为“静音”时，您的对讲机在紧急呼叫模式下不会显示任何语音或视觉提示。

按照步骤在对讲机上发送紧急警报。

1 按预设的**紧急呼叫**开按钮。

您看到这些结果中的一个：

- 显示屏显示发射警报和目标别名。
-  显示屏显示发射电报和目标别名。

LED 绿灯亮起。 **紧急呼叫**图标出现。



说明：

如果已预设，紧急搜索提示音将响起。对讲机发射或接收语音时，此提示音为静音，对讲机退出紧急呼叫模式，此提示音将停止。紧急搜索音可通过 CPS 预设。

2 等待确认。

如果成功：

- 紧急呼叫提示音将响起。
- LED 红灯闪烁。
- 显示屏显示已发警报。

如果在已达到最大重试次数后仍不成功：

- 将发出一声提示音。
- 显示屏显示警报失败。

对讲机退出紧急警报模式并返回主屏幕。

发送带呼叫的紧急警报

该功能允许您向一组对讲机发送带呼叫的紧急警报。经该组中的对讲机确认后，这一组对讲机可以通过预设的紧急信道进行通信。

按照步骤在对讲机上发送带呼叫的紧急警报。

- 1 按预设的**紧急呼叫**开按钮或**紧急呼叫**脚踏开关。显示屏将显示正在发送警报，交替显示对讲机 ID。

您将看到以下内容：

- 显示屏显示发射电报和目标别名。

LED 绿灯亮起。 **紧急呼叫**图标出现。



说明：

如果已预设，紧急搜索提示音将响起。对讲机发射或接收语音时，此提示音为静音，对讲机退出紧急呼叫模式，此提示音将停止。紧急搜索提示音可由您的经销商或系统管理员预设。

- 2 等待确认。
如果成功：

- 紧急呼叫提示音将响起。
- LED 红灯闪烁。
- 显示屏将显示已发警报。
- 显示屏显示紧急呼叫及目标通话组别名时，对讲机将进入紧急呼叫模式。

- 3 按 **PTT** 键发起呼叫。

LED 绿灯亮起。 显示屏显示**组呼**图标。

- 4 执行以下操作之一：

- 等通话许可提示音结束后（启用该功能时）对着麦克风清楚地讲话。
-  等 **PTT** 侧音结束后（启用该功能时）对着麦克风清楚地讲话。

- 5 释放 **PTT** 按钮接听。

显示屏显示呼叫方和通话组别名。

- 6  如果启用“信道空闲提示”功能，则当发射对讲机释放 **PTT** 时，您将会听到一声短的提示音，表示此信道空闲，您可以应答。按 **PTT** 来回复该呼叫。

- 7 要在呼叫结束后退出紧急呼叫模式，请按**紧急呼叫**关闭按钮。

对讲机将返回主屏幕。

带语音跟随的紧急警报

该功能允许您向一组对讲机发送带语音跟随的紧急警报。对讲机的麦克风会自动激活，您无需按 **PTT** 按钮即可与该组对讲机进行通信。这种激活的麦克风状态又称为**紧急麦克风**。



说明：

您的对讲机无法检测到后置附件连接器连接的非 **IMPRES** 麦克风。

在指定的已预设连接器处未检测到麦克风时，对讲机将检查备用连接器。这时，对讲机将优先使用检测到的麦克风。

如果对讲机已启用紧急循环模式，则会在预设的持续时间内重复**紧急麦克风**和接收时间段。在紧急循环模式期间，通过扬声器收到呼叫音。

如果在预设的接收时间段内按 **PTT** 按钮，您将听到一声禁止提示音，指示您应释放 **PTT** 按钮。对讲机将忽略 **PTT** 按钮按下操作并保持紧急呼叫模式。

如果您在**紧急麦克风**期间按 **PTT** 按钮，并在**紧急麦克风**持续时间结束后继续按该按钮，则对讲机继续发射直至您释放 **PTT** 按钮。

如果紧急警报请求发送失败，对讲机不会再尝试发送请求，而会直接进入**紧急麦克风**状态。



说明：

一些附件可能不支持**紧急麦克风**。请联系您的经销商或系统管理员了解详情。

发送带语音跟随的紧急警报

按照步骤在对讲机上发送带语音跟随的紧急警报。

- 1 按预设的**紧急呼叫**开按钮或**紧急呼叫**脚踏开关。

您看到这些结果中的一个：

- 显示屏显示发射警报和目标别名。
- 显示屏显示发射电报和目标别名。

LED 绿灯亮起。 **紧急呼叫**图标出现。

- 2 显示屏显示已发警报后，对着麦克风清晰地讲话。对讲机将在以下情况下自动停止发射：

- 在启用了紧急循环模式时，**紧急麦克风**和接收呼叫之间的循环持续时间结束。
- 在禁用紧急循环模式时，**紧急麦克风**的持续时间结束。

3 按**紧急呼叫**按钮退出紧急呼叫模式。

对讲机将返回主屏幕。

重新启动紧急呼叫模式

该功能仅适用于发送紧急报警信号的对讲机。按照步骤在对讲机上重新启动紧急呼叫模式。

执行以下操作之一：

- 当对讲机处于紧急呼叫模式时更改信道。如果在新信道上启用了紧急警报，对讲机将退出紧急呼叫模式，并重新启动紧急呼叫。
 - 在紧急呼叫发起或传输状态下，按预设的**紧急呼叫**按钮。对讲机将退出此状态，并重新启动紧急呼叫。
-

发送紧急报警后退出紧急模式

该功能仅适用于发送紧急报警信号的对讲机。

在下列情况下，对讲机退出紧急呼叫模式：

- 收到确认（仅适用于紧急警报）。
- 已达到发送警报的最大尝试次数。



说明：

如果关机，对讲机将退出紧急呼叫模式。当对讲机再次打开时，将不会自动重新进入紧急模式。

按照步骤在对讲机上退出紧急呼叫模式。

执行以下操作之一：



- 按预设的**紧急呼叫**按钮。
 - 将信道更改到一个未配置紧急呼叫系统的新信道。显示屏显示无紧急呼叫。
-



从警报列表中删除警报项目



按照步骤从警报列表中删除警报项目，以退出紧急呼叫模式。

1

按  访问菜单。

2 按  或  显示警报列表。按  进行选择。

3 按  或  显示所需的警报项目。按  进行选择。

4 按  或  显示删除。按  进行选择。

短信发送

您的对讲机可以接收数据，例如来自另一对讲机或短信应用程序的短信。

提供两种类型的短信，即数字车载台对讲机 (DMR) 短信和普通短信。一条 DMR 短信的最大长度为 23 个字符。一条普通短信的最大长度为 280 个字符，包括主题行。仅当从电子邮件应用程序收到消息时，主题行才会出现。



说明：

最大字符长度仅适用于具有最新软件和硬件的型号。对于具有较旧软件和硬件的对讲机型号，一条普通短信的最大长度为 140 个字符。请联系您的经销商或系统管理员了解详情。

短信



短信存储在收件箱中，并按照从新到旧的接收顺序排序。

查看短信

按照步骤在对讲机上查看短信。



1 按  访问菜单。

2 按  或  显示信息。按  进行选择。

3 按  或  显示收件箱。按  进行选择。

如果收件箱为空：

- 显示屏显示列表为空。
- 如果键盘音开启，对讲机会发出一声提示音。

4 按  或  显示所需的短信。按  进行选择。



如果短信来自电子邮件应用程序，显示屏会显示主题行。



查看遥感遥测状态短信

按照步骤查看收件箱中的遥感遥测状态短信。

1 按  访问菜单。

2 按  或  显示信息。按  进行选择。

3 按  或  显示收件箱。按  进行选择。

4 按  或  显示所需的短信。按  进行选择。

您不能回复遥感遥测状态短信。

显示屏显示遥感遥测：<状态短信>。

5 长按  返回主屏幕。

回复短信

按照步骤在对讲机上回复短信。

当您收到短信时：

- 显示屏显示含有发送者别名或 ID 的通知列表。
- 显示屏显示消息图标。





说明：

如果按 **PTT** 按钮，则对讲机将退出短信提示屏幕，并对短信发送者设置单呼或组呼。

1 执行以下操作之一：

- 按  或  显示阅读。按  进行选择。
显示屏显示短信。如果短信来自电子邮件应用程序，显示屏会显示主题行。
 - 按  或  显示稍后阅读。按  进行选择。
对讲机返回到接收短信前您所在的屏幕。
 - 按  或  显示删除。按  进行选择。
-

2 执行以下操作之一：



- 按  返回收件箱。
 - 再按一次  回复、转发或删除短信。
-

用预制短信回复短信



按照步骤在对讲机上用预制短信回复短信。

1 执行以下操作之一：

- 按预设的**短信**按钮。继续步骤 [步骤 3](#)。
- 按  访问菜单。

2 按  或  显示信息。按  进行选择。



3 按  或  显示收件箱。按  进行选择。



4 按  或  显示所需的短信。按  进行选择。

如果短信来自电子邮件应用程序，显示屏会显示主题行。

5 按  访问子菜单。

6 按  或  显示回复。按  进行选择。

7 按  或  显示快速回复。按  进行选择。

8 按  或  显示所需的短信。按  进行选择。

显示屏显示过渡性的小型通知，确认正在发送短信。

9 等待确认。

如果成功：

- 将发出一声提示音。
- 显示屏显示确定性的小型通知。

如果失败：

- 将发出一声提示音。
- 显示屏显示否定性的小型通知。
- 对讲机返回重发选项屏幕。

重发短信

按照步骤在对讲机上重发短信。

处于重发选项屏幕时：

按  将同一短信重发给同一用户或组别名或 ID。

如果成功：

- 发出一声确定提示音。
- 显示屏显示确定性的小型通知。



如果失败：



- 发出一声否定提示音。
- 显示屏显示否定性的小型通知。
- 对讲机返回重发选项屏幕。

转发短信

按照步骤在对讲机上转发短信。

处于重发选项屏幕时：

1 按  或  显示转发，然后按  将同一短信发送到另一个用户或通话组别名或 ID。

2 按  或  显示所需的别名或 ID。按  进行选择。

显示屏显示过渡性的小型通知，确认正在发送短信。

3 等待确认。

如果成功：

- 发出一声确定提示音。
- 显示屏显示确定性的小型通知。

如果失败：

- 发出一声否定提示音。
- 显示屏显示否定性的小型通知。











说明：

您也可以手动选择目标对讲机地址（请参阅[使用手动拨号转发短信 \(第 349 页\)](#)）。

使用手动拨号转发短信

按照步骤使用手动拨号在对讲机上转发短信。

- 1 按  或  显示转发。按  进行选择。
- 2 按  将同一短信发送给另一用户或通话组别名或 ID。
- 3 按  或  显示手动拨号。按  进行选择。
显示屏显示对讲机号：。
- 4 输入用户 ID，然后按  继续。
显示屏显示过渡性的小型通知，确认正在发送短信。
- 5 等待确认。
如果成功：
 - 将发出一声提示音。
 - 显示屏显示确定性的小型通知。
 如果失败：

- 将发出一声提示音。
- 显示屏显示否定性的小型通知。

编辑短信

选择编辑以编辑短信。











说明：

如果有主题行（对从电子邮件程序接收到的短信），您不能对该主题行进行编辑。

- 1 按  或  显示编辑。按  进行选择。
显示屏显示一个闪烁的光标。
- 2 用键盘编辑您的短信。
 - 按  向左移动一个空格。
 - 按  或  向右移动一个空格。
 - 按  删除任何无用的字符。
 - 长按  更改文本输入方法。

3 写完信息后按 。

4 执行以下操作之一：

- 按  或  至发送，然后按  以发送短信。
- 按  或  至保存，然后按  以将短信保存至草稿箱文件夹。
- 按  以编辑短信。
- 按  以选择删除短信或将其保存至草稿箱文件夹。



编写短信

按照步骤在对讲机上编写短信。

1 执行以下操作之一：

- 按预设的**短信**按钮。继续 [步骤 3](#)。
- 按  访问菜单。

2 按  或  显示信息。按  进行选择。

3 按  或  显示编辑。按  进行选择。此时将出现闪烁光标。

4 用键盘输入信息。

按  向左移动一个空格。

按  或  向右移动一个空格。

按  删除任何无用的字符。

长按  更改文本输入方法。

5 写完信息后按 。

执行以下操作之一：







- 按  发送信息。
- 按 。按  或  选择编辑、删除或保存信息。按  进行选择。

发送短信

按照步骤在对讲机上发送短信。

它假定您有新编写的短信或保存的短信。

选择收件人。执行以下操作之一：

- 按  或  显示所需的别名或 ID。按  进行选择。
- 按  或  显示手动拨号。按  进行选择。键入用户 ID。屏幕第一行显示对讲机号码：。屏幕第二行显示闪烁的光标。键入用户别名或 ID。按 。

屏幕显示过渡性的小型通知，确认正在发送短信。

如果成功：

- 将发出一声提示音。
- 屏幕显示确定性的小型通知。

如果失败：

- 一声低音调提示音响起。
- 屏幕显示否定性的小型通知。
- 短信被移至“已发信息”文件夹中。

- 短信标记为“发送失败”图标。



说明：

对于新编写的短信，对讲机将返回重发选项屏幕。



删除收件箱中的短信

按照步骤删除对讲机收件箱中的短信。



1 执行以下操作之一：

- 按预设的**短信**按钮。继续 [步骤 3](#)。
- 按  访问菜单。

2



按  或  显示信息。按  进行选择。

3

按  或  显示收件箱。按  进行选择。



如果收件箱为空：



- 显示屏显示列表为空。
- 将发出一声提示音。

- 4 按  或  显示所需的短信。按  进行选择。



如果短信来自电子邮件应用程序，显示屏会显示主题行。

- 5 按  访问子菜单。

- 6 按  或  显示删除。按  进行选择。

- 7 按  或  显示是。按  进行选择。



显示屏显示确定性的小型通知。屏幕返回到收件箱。



- 2 按  或  显示信息。按  进行选择。

- 3 按  或  显示收件箱。按  进行选择。

如果收件箱为空：

- 显示屏显示列表为空。
- 将发出一声提示音。

- 4 按  或  显示全部删除。按  进行选择。

- 5 按  或  显示是。按  进行选择。

显示屏显示确定性的小型通知。

删除收件箱中的所有短信

按照步骤删除对讲机收件箱中的全部短信。

- 1 执行以下操作之一：
- 按预设的**短信**按钮。继续 [步骤 3](#)。
 - 按  访问菜单。

发送短信

将短信发送给另一对讲机后，它就会保存到已发信息文件夹中。始终将最近发送的短信添加到已发信息文件夹的顶部。您可以重发、转发、编辑或删除已发送的短信。

已发信息文件夹最多可存储 **30** 条最近发送的短信。当此文件夹已满后，下一条已发送的短信会自动替换此文件夹中最早的短信。

如果您在发送短信时退出短信发送屏幕，则对讲机将在“已发信息”文件夹中对短信状态进行更新，而不显示提示或通过声音提示。

如果已发信息文件夹里的短信状态在更新之前，对讲机模式发生改变或断电，则对讲机将无法完成正在进行的短信处理，并自动将其标记为**发送失败**图标。

对讲机最多可以同时处理五条短信。在此阶段，对讲机不能发送新的短信，并自动将其标记为**发送失败**图标。

在任何时候长按 ，对讲机都将返回主屏幕。



说明：



如果信道类型（如传统数字或智能信道共享信道）不匹配，则只能编辑、转发或删除已发送的短信。

查看已发送短信

按照步骤在对讲机上查看已发送短信。



- 1 执行以下操作之一：
 - 按预设的**短信**按钮。继续 [步骤 3](#)。
 - 按  访问菜单。

- 2 按  或  显示信息。按  进行选择。

- 3 按  或  显示已发信息。按  进行选择。

如果已发信息文件夹为空：

- 显示屏显示列表为空。
- 如果键盘音开启，对讲机会发出一声较低的提示音。



- 4 按  或  显示所需的短信。按  进行选择。

屏幕右上角的图标表示短信的状态。请参阅 [已发信息图标](#)。

发送已发送短信

按照步骤在对讲机上发送已发送短信。

查看已发送短信时：

- 1 当查看短信时，按  。
- 2 您可以重发或转发已发送短信。执行以下操作之一：
 -  显示重发。按  进行选择。

-  显示转发。按  进行选择。

显示屏显示过渡性的小型通知，确认正在发送短信。

3 等待确认。

如果成功：

- 发出一声确定提示音。
- 显示屏显示确定性的小型通知。

如果失败：

- 发出一声否定提示音。
- 显示屏显示否定性的小型通知。
- 对讲机将转入重发选项屏幕。有关详细信息，请参阅 [重发短信 \(第 120 页\)](#)。

删除已发信息文件夹中的已发送短信

按照步骤删除对讲机已发信息文件夹中的已发送短信。

查看已发送短信时：

- 1 按  。

- 2 按  或  显示删除。按  进行选择。



删除已发信息文件夹中的全部已发送短信

按照步骤删除对讲机已发信息文件夹中的全部已发送短信。

1 执行以下操作之一：



- 按预设的 **短信** 按钮。继续 [步骤 3](#)。
- 按  访问菜单。

- 2 按  或  显示信息。按  进行选择。







- 3 按  或  显示已发信息。按  进行选择。

如果已发信息文件夹为空：

- 显示屏显示列表为空。
- 将发出一声提示音。

- 4 按  或  显示全部删除。按  进行选择。

5 执行以下操作之一：

- 按  或  显示是。按  进行选择。显示屏显示确定性的小型通知。
- 按  或  显示否。按  进行选择。对讲机返回到前一屏幕。

- 按预设的**短信**按钮。继续 [步骤 3](#)。
- 按  访问菜单。

保存的短信

您可以保存短信以便稍后发送。

如果您在编写或编辑短信时按了**通话按钮**或模式更改导致对讲机退出短信编写/编辑屏幕，则当前的短信将被自动保存到“草稿箱”文件夹中。









最后保存的短信始终被加到“草稿箱”列表的顶部。

“草稿箱”文件夹最多可存储 **10** 条最近保存的短信。当此文件夹已满后，下一条保存的短信会自动替换此文件夹中最早的短信。

查看已保存的短信

按照步骤在对讲机上查看已保存的短信。



1 执行以下操作之一：

- 按  或  显示消息。按  进行选择。
- 按  或  显示草稿。按  进行选择。
- 按  或  显示所需的短信。按  进行选择。

编辑已保存的短信

按照步骤在对讲机上编辑保存的短信。

- 当查看短信时，按 。
- 按  或  显示编辑。按  进行选择。此时将出现闪烁光标。
- 用键盘输入信息。
按  向左移动一个空格。

按  或  向右移动一个空格。

按  删除任何无用的字符。

长按  更改文本输入方法。

4 写完信息后按 。

执行以下操作之一：

- 按  或  显示发送。按  发送信息。
- 按 。按  或  以选择保存信息或删除信息。按  进行选择。



删除“草稿箱”文件夹中保存的短信



按照步骤删除对讲机上草稿箱中保存的短信。

1 执行以下操作之一：

- 按预设的**短信**按钮。继续 [步骤 3](#)。
- 按  访问菜单。

2 按  或  显示消息。按  进行选择。

3 按  或  显示草稿。按  进行选择。

4 按  或  显示所需的短信。按  进行选择。

5 按  或  显示删除。按  删除短信。

预制短信

通过经销商预编程，您的对讲机最多可支持 **50** 条快速文本信息。

当预定义了预制短信时，您可以在发送每个短信之前对其进行编辑。

发送预制短信



按照步骤在对讲机上向预定义别名发送预制短信。



1 执行以下操作之一：

- 按预设的**短信**按钮。继续 [步骤 6](#)。

- 按预设的**单键接入**按钮。
显示屏显示过渡性的小型通知，确认正在发送短信。
继续 [步骤 6](#)。
- 按  访问菜单。

2 按  或  显示信息。按  进行选择。

3 按  或  显示预制短信。按  进行选择。

4 按  或  显示所需的预制短信。按  进行选择。

5 执行以下操作以选择收件人并发送短信。
显示屏显示过渡性的小型通知，确认正在发送短信。

- 6** 等待确认。
- 如果成功：
- 发出一声确定提示音。
 - 显示屏显示确定性的小型通知。

如果失败：

- 发出一声否定提示音。
- 显示屏显示否定性的小型通知。
- 对讲机将转入重发选项屏幕。有关详细信息，请参阅 [重发短信 \(第 120 页\)](#)。

文本输入配置

您的对讲机允许您配置不同文本。

您可在对讲机上输入文本来配置以下设置：



- 字词预测
- 字词纠正
- 句首大写
- 我的新词

您的对讲机支持以下文本输入方法：

- 数字
- 符号
- 预测或多次击键
- 语言（如果已预设）



说明:





在任何时候按  都可以返回上一个屏幕或长按  返回主屏幕。不活动计时器超时后，对讲机退出当前屏幕。

启用或禁用文字校正

在内置字典无法识别输入文本编辑器中的字词时提供替代字词选择。







- 1 按  访问菜单。
- 2 按  或  显示设置。按  进行选择。
- 3 按  或  显示对讲机设置。按  进行选择。
- 4 按  或  显示文本输入。按  进行选择。
- 5 按  或  显示文字校正。按  进行选择。



6 执行以下操作之一：



- 按  或  显示文字校正。按  进行选择。
- 按 启用文字校正。如果启用，已启用旁出现 。
- 按 禁用文字校正。如果禁用，已启用旁的  消失。

启用或禁用词语预测





词语预测：您的对讲机可记住您经常输入的常用词序列。在您将常用词序列的第一个字输入到文本编辑器后，对讲机随后会预测下一个您可能会使用的字。

- 1 按  访问菜单。
- 2 按  或  显示设置。按  进行选择。
- 3 按  或  显示对讲机设置。按  进行选择。

4 按  或  显示文本输入。按  进行选择。

5 按  或  显示词语预测。按  进行选择。



6 执行以下操作之一：



- 按  启用词语预测。如果启用，已启用旁出现 。
 - 按  禁用麦克风动态失真控制。如果禁用，已启用旁的  消失。
-



句首大写



此功能用来自动使每个新句子的第一个单词的首字母大写。

1 按  访问菜单。





2 按  或  显示设置。按  进行选择。

3 按  或  显示对讲机设置。按  进行选择。

4 按  或  显示文本输入。按  进行选择。

5 按  或  显示句首大写。按  进行选择。

6 执行以下操作之一：

- 按  启用句首大写。如果启用，已启用旁出现 。
 - 按  禁用句首大写。如果禁用，已启用旁的  消失。
-

查看自定义字词

您可以将自己的自定义字词添加到对讲机的内置字典中。您的对讲机将保留一个包含这些字词的列表。

- 1 按  访问菜单。

- 2 按  或  显示设置。按  进行选择。

- 3 按  或  显示对讲机设置。按  进行选择。

- 4 按  或  显示文本输入。按  进行选择。

- 5 按  或  显示我的新词。按  进行选择。

- 6 按  或  显示字词列表。按  进行选择。
屏幕显示自定义字词列表。

编辑自定义字词

您可编辑对讲机中保存的自定义字词。

- 1 按  访问菜单。



- 2 按  或  显示设置。按  进行选择。

- 3 按  或  显示对讲机设置。按  进行选择。

- 4 按  或  显示文本输入。按  进行选择。





- 5 按  或  显示我的新词。按  进行选择。

- 6 按  或  显示字词列表。按  进行选择。
屏幕显示自定义字词列表。

7 按  或  显示所需字词。按  进行选择。

8 按  或  显示编辑。按  进行选择。

9 使用键盘编辑自定义字词。

- 按  向左移动一个空格。
- 按  键向右移动一个空格。
- 按  键删除任何无用的字符。
- 长按  更改文本输入方法。

10 自定义字词完成后按 。



屏幕显示过渡性的小型通知，确认正在保存自定义字词。



- 如果自定义字词已保存，发出一声提示音，且屏幕显示确定性的小型通知。
- 如果自定义字词未保存，发出一声低调提示音，且屏幕显示否定性的小型通知。



添加自定义字词



您可以将自定义字词添加到内置对讲机字典中。



1 按  访问菜单。

2 按  或  显示设置。按  进行选择。

3 按  或  显示对讲机设置。按  进行选择。





4 按  或  显示文本输入。按  进行选择。

5 按  或  显示我的新词。按  进行选择。

6 按  或  显示添加新词。按  进行选择。

屏幕显示自定义字词列表。

7 使用键盘编辑自定义字词。

- 按  向左移动一个空格。
- 按  键向右移动一个空格。
- 按  键删除任何无用的字符。
- 长按  更改文本输入方法。

8 自定义字词完成后按 。

屏幕显示过渡性的小型通知，确认正在保存自定义字词。

- 如果自定义字词已保存，发出一声提示音，且屏幕显示确定性的小型通知。
- 如果自定义字词未保存，发出一声低调提示音，且屏幕显示否定性的小型通知。

删除自定义字词

按照步骤删除保存在对讲机中的自定义字词。

1 按 访问菜单。

2 按 或 显示设置。按 进行选择。

3 按 或 显示对讲机设置。按 进行选择。





4 按 或 显示文本输入。按 进行选择。

5 按 或 显示我的新词。按 进行选择。

6 按 或 显示所需字词。按 进行选择。

7 按 或 显示删除。按 进行选择。

8 选择以下选项之一。

- 出现删除条目？时，按  选择是。屏幕显示条目已删除。
 - 按  或  显示否。按  返回前一屏幕。
-

删除全部自定义字词

按照步骤删除对讲机内置字典中的全部自定义字词。

- 1 按  访问菜单。

- 2 按  或  显示设置。按  进行选择。





- 3 按  或  显示对讲机设置。按  进行选择。

- 4 按  或  显示文本输入。按  进行选择。

- 5 按  或  显示我的新词。按  进行选择。

- 6 按  或  显示全部删除。按  进行选择。

- 7 执行以下操作之一：

- 出现删除条目？时，按  选择是。显示屏显示所有条目已删除。
- 按  或  显示否以返回前一屏幕。按  进行选择。

任务

此功能允许您的对讲机接收调度员发送的信息，列出了要执行的任务。



说明：

此功能可以根据用户要求通过 CPS 自定义。请联系您的经销商或系统管理员了解详情。

有两个文件夹包含不同的任务：

我的任务文件夹

分配给您的登录用户 ID 的个性化任务。

共享任务文件夹

分配给个人组的共享任务。

您可以回复任务，以便将任务分类到任务文件夹中。默认情况下，这些文件夹包括**全部**、**新增**、**已启动**和**已完成**。有关其他 10 个文件夹，请联系您的经销商或系统管理员。

**说明：**

甚至在关闭对讲机并重新打开之后，仍会保留这些任务。

所有任务均位于**全部**文件夹。根据您的对讲机的预设方式，任务按其优先级再按接收时间排序。首先列出新任务、最近更改了状态的任务以及优先级最高的任务。达到最大任务数时，下一个任务会自动替换对讲机中的最后一个任务。您的对讲机最多支持 **100** 或 **500** 个任务，具体取决于您的对讲机型号。请联系您的经销商或系统管理员了解详情。您的对讲机自动检测和丢弃具有相同任务 ID 的重复任务单。

根据任务的重要性，调度员会为其添加优先级。有三个优先级：优先级 **1**、优先级 **2** 和优先级 **3**。优先级 **1** 是最高优先级，而优先级 **3** 是最低优先级。也有无优先级的任务。

调度员进行以下更改时，您的对讲机将相应更新：



- 修改任务的内容。
- 添加或编辑任务的优先级。
- 在文件夹之间移动任务。
- 取消任务。



访问“任务”文件夹



按照步骤访问“任务”文件夹。

1 执行以下操作之一：

- 按预设的**任务**按钮。继续 **步骤 3**。
- 按  访问菜单。

2 按  或  显示任务单。按  进行选择。



3 按  或  显示所需的文件夹。按  进行选择。

4 按  或  显示所需的任务单。按  进行选择。

登录远程服务器或从远程服务器注销

此功能允许以您的用户 ID 登录远程服务器和从远程服务器注销。

1 按  访问菜单。

2 按  或  以登录。按  进行选择。

如果已登录，菜单将显示注销。

显示屏显示过渡性的小型通知，指示正在处理该请求。

3 等待确认。

如果成功：

- 发出一声确定提示音。
- 显示屏显示确定性的小型通知。

如果失败：

- 发出一声否定提示音。
- 显示屏显示否定性的小型通知。



创建任务

您的对讲机可以基于任务模板创建任务，以及发送需要执行的任务。

需要 CPS 编程软件来配置任务单模板。

- 1 按  访问菜单。



- 2 按  或  显示任务。按  进行选择。



- 3 按  或  显示创建任务单。按  进行选择。



回复任务

按照步骤在对讲机上回复任务。

- 1 按  访问菜单。



- 2 按  或  显示任务。按  进行选择。

- 3 按  或  显示所需的文件夹。按  进行选择。

- 4 按  或  显示所需的任务。按  进行选择。

- 5 再次按  进入子菜单。

您也可以按相应的数字键 (1 - 9) 来快速回复。

- 6 按  或  显示所需的任务。按  进行选择。

显示屏显示过渡性的小型通知，指示正在处理该请求。

- 7 等待确认。

如果成功：

- 发出一声确定提示音。
- 显示屏显示确定性的小型通知。



如果失败：



- 发出一声否定提示音。
 - 显示屏显示否定性的小型通知。
-



使用一个任务模板发送任务

如果对讲机配置了一个任务模板，请执行以下操作以发送任务。

- 1 使用键盘输入所需的房号。按  进行选择。
-

- 2 按  或  显示房间状态。按  进行选择。
-

- 3 按  或  显示所需的选项。按  进行选择。
-

- 4 按  或  显示发送。按  进行选择。
显示屏显示过渡性的小型通知，指示正在处理该请求。
-

- 5 等待确认。

如果成功：



- 发出一声确定提示音。
- 显示屏显示确定性的小型通知。



如果失败：

- 发出一声否定提示音。
 - 显示屏显示否定性的小型通知。
-

使用多个任务模板发送任务

如果对讲机配置了多个任务模板，请执行以下操作以发送任务。

1 按  或  显示所需的选项。按  进行选择。

2 按  或  显示发送。按  进行选择。
显示屏显示过渡性的小型通知，指示正在处理该请求。

3 等待确认。

如果成功：

- 发出一声确定提示音。
- 显示屏显示确定性的小型通知。

如果失败：

- 发出一声否定提示音。
 - 显示屏显示否定性的小型通知。
-



删除任务



按照步骤删除对讲机上的任务。



1 执行以下操作之一：

- 按预设的**任务**按钮。继续 [步骤 4](#)
 - 按  访问菜单。
-



2 按  或  显示任务。按  进行选择。

3 按  或  显示所需的文件夹。按  进行选择。

4 按  或  显示全部文件夹。按  进行选择。

5 按  或  显示所需的任务。按  进行选择。

6 查看任务时，再按一次  。

- 7 按  或  显示删除。按  进行选择。
显示屏显示过渡性的小型通知，指示正在处理该请求。
-



- 8 等待确认。
如果成功：
- 发出一声确定提示音。
 - 显示屏显示确定性的小型通知。
- 如果失败：
- 发出一声否定提示音。
 - 显示屏显示否定性的小型通知。
-



删除所有任务



按照步骤删除对讲机上的所有任务。







- 1 执行以下操作之一：
- 按预设的**任务**按钮。继续 [步骤 3](#)。
 - 按  访问菜单。
-

- 2 按  或  显示任务。按  进行选择。
-

- 3 按  或  显示所需的文件夹。按  进行选择。
-

- 4 按  或  显示全部文件夹。按  进行选择。
-

- 5 按  或  显示全部删除。按  进行选择。
-

- 6 执行以下操作之一：
- 按  或  显示是。按  进行选择。
显示屏显示确定性的小型通知。
 - 按  或  显示否。按  进行选择。
对讲机返回到前一屏幕。
-

加密

此功能有利于防止信道上未经授权的用户利用软件加密解决方案进行窃听。发射的信令和用户识别部分未加密。

对讲机必须启用信道的加密功能才能发送加密发射信号，虽然这不是接收发射的必需要求。在启用加密的信道上，对讲机仍能接收清晰或未加密的传输信号。

一些对讲机型号可能不提供加密功能，或可能会有不同的配置。请联系您的经销商或系统管理员了解详情。

您的对讲机支持两种类型的加密，但只有一种类型可被分配给您的对讲机。它们分别是：

- 基本加密
- 增强型加密

要对启用加密的呼叫或数据传输进行解密，必须对您的对讲机进行预设，以与发射对讲机具有相同的密钥（基本加密）或具有相同的密钥值和密钥 ID（增强型加密）。

如果对讲机接收到加密密钥不同或密钥值和密钥 ID 不同的加密呼叫，您要么将听到混乱不清的传输信号（基本加密），要么什么都听不到（增强型加密）。

您的对讲机可在加密信道上接收清晰或未加密的呼叫，具体取决于对讲机的设定方式。此外，根据设定方式，您的对讲机还可发出警告音。

当对讲机传输信号时，绿色 LED 指示灯亮起，而当对讲机接收传入的加密传输信号时，绿色 LED 指示灯则快速闪烁。



说明：

此功能不适用于频率相同的民用频段信道。

打开或关闭加密

按照步骤打开或关闭对讲机上的加密。

- 1 执行以下操作之一：
 - 按预设的**加密**按钮。跳过以下步骤。
 - 按  访问菜单。

- 2 按  或  显示设置。按  进行选择。

- 3 按  或  显示对讲机设置。按  进行选择。

- 4 按  或  显示加密。按  进行选择。

- 5 执行以下操作之一：

- 按  或  显示开。按  进行选择。显示屏在开旁边显示 。
- 按  或  显示关。按  进行选择。显示屏在关旁边显示 。

响应抑制

此功能有助于防止对讲机响应任何呼入传输。



说明：

这是一项可购买功能。咨询经销商或系统管理员以确定对讲机的预设情况。

如果启用此功能，则您的对讲机将不会生成任何呼出传输，以响应呼入传输，如对讲机检测、呼叫提示、对讲机遥毙、远程监听、自动注册服务 (ARS)、响应私人消息和发送 GNSS 定位报告。如果启用此功能，则您的对讲机无法接收已确认单呼。但是，您的对讲机可以手动发送传输。

打开或关闭响应抑制

按照步骤启用或禁用对讲机上的响应抑制。

按预设的**响应抑制**按钮。

如果成功：

- 发出一声确定提示音。
- 显示屏显示确定性的小型瞬间通知。

如果失败：

- 发出一声否定提示音。
- 显示屏显示否定性的小型瞬间通知。

多站点控制

当您当前的对讲机信道是 IP 站点连接或智能信道共享 - 多站点配置的一部分时，这些功能适用。

启动手动站点搜索

按照步骤在接收到的信号强度较差时启动手动站点搜索，以尝试查找信号更强的站点。

如果对讲机发现新站点：

- 发出一声确定提示音。

如果对讲机未找到新站点：

- 发出一声否定提示音。

站点锁定开/关

切换为打开时，对讲机只搜索当前站点。切换为关闭时，对讲机将搜索当前站点和其他站点。

按预设的**站点锁定**按钮。

如果**站点锁定**功能切换为开启：

- 您将听到确定提示音，表示对讲机已锁定到当前站点。
- 屏幕显示站点已锁定。



如果**站点锁定**功能切换为关闭：



- 您会听到否定提示音，表示对讲机已解锁。
- 屏幕显示站点已解锁。



访问邻域站点列表

此功能可允许用户查看当前主站点的邻近站点列表。按照步骤访问“邻域站点”列表：

- 1 按  访问菜单。

- 2 按  或  显示设置。按  进行选择。

- 3 按  或  显示对讲机信息。按  进行选择。

- 4 按  或  显示邻域站点。按  进行选择。

安保

此功能允许您启用或禁用系统中的任何对讲机。

例如，您可能想要禁用被盗的对讲机以防止未经授权的用户使用，并在对讲机恢复后启用它。

启用或禁用对讲机的方法有两种：利用身份验证或不利用身份验证。

身份验证对讲机遥毙是一项可购买功能。在身份验证对讲机遥毙中，当您启用或禁用对讲机时，需要进行验证。当您的对讲机利用用户身份验证在目标对讲机上发起此功能时，需要口令。该口令已通过 **CPS** 在目标对讲机中预设。

如果在对讲机激活或对讲机遥毙操作期间按 ，您将不会收到确认。



说明:

请联系您的经销商或系统管理员了解详情。

禁用对讲机

按照步骤禁用对讲机。

1 按预设的**对讲机**按钮。

2 按  或  显示所需的别名或 ID。

3 按  进行选择。会发生以下情况之一：

- 显示屏显示过渡性的小型通知，指示正在处理该请求。LED 绿灯闪烁。
- 出现口令屏幕。

输入口令。按  继续。

- 如果口令正确，显示屏显示过渡性的小型通知，指示正在处理该请求。LED 绿灯亮起。
 - 如果口令错误，显示屏将显示否定性的小型通知，并返回上一个屏幕。
-

4 等待确认。

如果成功：

- 发出一声确定提示音。
- 显示屏显示确定性的小型通知。



如果失败：



- 发出一声否定提示音。
 - 显示屏显示否定性的小型通知。
-

使用通讯录列表禁用对讲机

按照步骤使用通讯录列表禁用对讲机。

1 按  访问菜单。

2 按  或  显示通讯录。按  进行选择。

3 按  或  显示所需的别名或 ID。按  进行选择。

4 按  或  显示对讲机按钮。

5 按  进行选择。会发生以下情况之一：

- 显示屏显示过渡性的小型通知，指示正在处理该请求。LED 绿灯闪烁。
- 出现口令屏幕。

输入口令。按  继续。

- 如果口令正确，显示屏显示过渡性的小型通知，指示正在处理该请求。LED 绿灯亮起。
- 如果口令错误，显示屏将显示否定性的小型通知，并返回上一个屏幕。

6 等待确认。

如果成功：

- 发出一声确定提示音。
- 显示屏显示确定性的小型通知。

如果失败：



- 发出一声否定提示音。
- 显示屏显示否定性的小型通知。



使用手动拨号禁用对讲机

按照步骤使用手动拨号禁用对讲机。

1 按  访问菜单。

2 按  或  显示通讯录。按  进行选择。

3 按  或  显示手动拨号。按  进行选择。

4 按  或  显示号码。按  进行选择。
第一行文字显示对讲机号：

5 输入用户 ID，然后按  继续。

6 按  或  显示对讲机遥毙。

7 按  进行选择。会发生以下情况之一：

- 显示屏显示过渡性的小型通知，指示正在处理该请求。LED 绿灯闪烁。

- 出现口令屏幕。

输入口令。按  继续。

- 如果口令正确，显示屏显示过渡性的小型通知，指示正在处理该请求。LED 绿灯亮起。
- 如果口令错误，显示屏将显示否定性的小型通知，并返回上一个屏幕。

8 等待确认。

如果成功：

- 发出一声确定提示音。
- 显示屏显示确定性的小型通知。

如果失败：

- 发出一声否定提示音。
- 显示屏显示否定性的小型通知。

激活对讲机

按照步骤激活对讲机。

1 按预设的对讲机激活按钮。

2 按 或 显示所需的别名或 ID。

3 按 进行选择。会发生以下情况之一：

- 显示屏显示对讲机激活及用户别名或 ID。LED 绿灯亮起。
- 出现口令屏幕。

输入口令。按  继续。

- 如果口令正确，显示屏显示过渡性的小型通知，指示正在处理该请求。LED 绿灯亮起。
- 如果口令错误，显示屏将显示否定性的小型通知，并返回上一个屏幕。

4 等待确认。

如果成功：

- 发出一声确定提示音。
- 显示屏显示确定性的小型通知。

如果失败：

- 发出一声否定提示音。
- 显示屏显示否定性的小型通知。

使用通讯录列表激活对讲机

按照步骤使用通讯录列表激活对讲机。

- 1 按  访问菜单。

- 2 按  或  显示通讯录。按  进行选择。

- 3 按  或  显示所需的别名或 ID。按  进行选择。

- 4 按  或  显示对讲机激活。

- 5 按  进行选择。会发生以下情况之一：
 - LED 绿灯闪烁。显示屏显示对讲机激活及用户别名或 ID。LED 绿灯亮起。
 - 出现口令屏幕。

输入口令。按  继续。

- 如果口令正确，显示屏显示过渡性的小型通知，指示正在处理该请求。LED 绿灯亮起。

- 如果口令错误，显示屏将显示否定性的小型通知，并返回上一个屏幕。

6 等待确认。

如果成功：

- 发出一声确定提示音。
- 显示屏显示确定性的小型通知。



如果失败：



- 发出一声否定提示音。
- 显示屏显示否定性的小型通知。



使用手动拨号激活对讲机

按照步骤使用手动拨号激活对讲机。

- 1 按  访问菜单。

- 2 按  或  显示通讯录。按  进行选择。

- 3 按  或  显示手动拨号。按  进行选择。

4 按  或  显示单呼。按  进行选择。

第一行文字显示对讲机号：

5 输入用户 ID，然后按  继续。

6 按  或  显示对讲机激活。

7 按  进行选择。会发生以下情况之一：

- LED 绿灯闪烁。显示屏显示对讲机激活及用户别名或 ID。LED 绿灯亮起。
- 出现口令屏幕。

输入口令。按  继续。

- 如果口令正确，显示屏显示过渡性的小型通知，指示正在处理该请求。LED 绿灯亮起。
- 如果口令错误，显示屏将显示否定性的小型通知，并返回上一个屏幕。

8 等待确认。

如果成功：

- 发出一声确定提示音。

- 显示屏显示确定性的小型通知。

如果失败：

- 发出一声否定提示音。
- 显示屏显示否定性的小型通知。

单独工作者

如果在预定义的时间内没有用户活动（例如按任何对讲机按钮或选择信道），此功能将提示用户需要发出紧急警报。

在一段预设的持续时间内没有用户活动之后，一旦不活动计时器到期，对讲机就使用语音提示向您发出预先警告。

如果在预定义的提醒计时器到期前您仍没有确认，对讲机将启动紧急警报。

只能将以下紧急警报之一分配给此功能：

- 紧急警报
- 带呼叫的紧急警报
- 带语音跟随的紧急警报 

对讲机一直处于紧急状态，允许语音信息继续，直到用户采取操作为止。有关退出紧急状态的方式的更多信息，请参阅[紧急操作 \(第 339 页\)](#)。

**说明:**

此功能仅限于已启用此功能的对讲机。请联系您的经销商或系统管理员了解详情。

蓝牙

该功能允许您通过蓝牙连接将您的对讲机与启用了蓝牙功能的设备（附件）一起使用。您的对讲机支持 **Motorola Solutions** 提供的以及市场上出售 (COTS) 的带蓝牙功能的设备。

蓝牙的有效视线距离是 10 米 (32 英尺)。该距离是指您的对讲机与已启用蓝牙功能设备之间的无障碍距离。为了实现高度可靠性，**Motorola Solutions** 建议不要将对讲机和附件分开。

在信号接收范围的边缘区域，您所听到的语音和提示音可能会变得“含混不清”或“断断续续”。要解决这一问题，请将您的对讲机和启用了蓝牙功能的设备彼此靠近一些（使它们在规定的 10 米范围内），以便重新接收能够提供清晰音频的较强信号。对讲机的蓝牙功能在 10 米范围内的最大功率为 2.5 mW (4 dBm)。

您的对讲机最多可同时与三个不同类型的蓝牙设备建立蓝牙连接。例如，同时与一个耳机、一个扫描仪和一个仅具备 PTT 功能的设备 (POD) 连接。您的对讲机不支持同时与多个同一类型的设备建立蓝牙连接。

请参阅相应蓝牙设备的用户手册，以了解更多支持蓝牙设备的全部功能。

**说明:**

如果通过 **CPS** 禁用，所有蓝牙相关功能都将禁用，并且蓝牙设备数据库将被擦除。

打开和关闭蓝牙





按照步骤打开和关闭蓝牙。

- 1 按  访问菜单。

- 2 按  或  显示蓝牙。按  进行选择。

- 3 按  或  显示我的状态。按  进行选择。
 屏幕显示开和关。当前状态通过  指示。

- 4 执行以下操作之一：
 - 按  或  显示开。按  进行选择。
 显示屏在开旁边显示 。

- 按  或  显示关。按  进行选择。显示屏在关旁边显示 。
-

连接到蓝牙设备

按照步骤连接至蓝牙设备。

打开您的蓝牙设备，并将其设置为配对模式。

- 1 按  访问菜单。
 - 2 按  或  显示蓝牙。按  进行选择。
 - 3 按  或  显示设备。按  进行选择。
 - 4 执行以下操作之一：
 - 按  或  显示所需的设备。按  进行选择。
 - 按  或  显示 查找设备以查找可用设备。按  或  显示所需的设备。按  进行选择。
-

- 5 按  或  显示连接。按  进行选择。

您的蓝牙设备可能需要您执行其他步骤以完成配对过程。有关详细信息，请参阅启用蓝牙设备的用户手册。

显示屏显示正在连接到 <设备>。

等待确认。

如果成功：

- 发出一声确定提示音。
- 显示屏显示<设备> 已连接和 **蓝牙已连接** 图标。
- 显示屏在已连接设备的旁边显示 。

如果失败：

- 发出一声否定提示音。
- 显示屏显示连接失败。



说明：

如果需要 PIN 代码，请参阅[使用密码访问对讲机 \(第 147 页\)](#)。

连接至处于可发现模式下的蓝牙设备

按照步骤连接至处于可发现模式下的蓝牙设备。

打开您的蓝牙设备，并将其设置为配对模式。

- 1 按  访问菜单。

- 2 按  或  显示蓝牙。按  进行选择。

- 3 按  或  显示查找我。按  进行选择。
现在，在预设的持续时间内，对讲机可以被其他支持蓝牙功能的设备找到。这就是“可发现模式”。

等待确认。
如果成功：

- 发出一声确定提示音。
- 显示屏显示<设备> 已连接和**蓝牙已连接**图标。
- 显示屏在已连接设备的旁边显示 .



如果失败：



- 发出一声否定提示音。
- 显示屏显示连接失败。



断开与蓝牙设备的连接



按照步骤断开蓝牙设备。

- 1 按  访问菜单。

- 2 按  或  显示蓝牙。按  进行选择。

- 3 按  或  显示设备。按  进行选择。

- 4 按  或  显示所需的设备。按  进行选择。

- 5 按  或  显示断开。按  进行选择。
显示屏显示正在与<设备>断开连接。



说明：

您的蓝牙设备可能需要您执行其他步骤以完成断开过程。请参阅启用蓝牙设备的相关用户手册。

等待确认。

- 将发出一声提示音。

- 显示屏显示<设备>已断开连接且**蓝牙已连接**图标消失。
- 已连接设备旁边的  消失。

在对讲机内部扬声器和蓝牙设备之间切换音频路由

按照步骤在对讲机内部扬声器和外部蓝牙设备之间切换音频路由。

按预设的**蓝牙音频切换**按钮。



屏幕将显示以下结果之一：



- 将发出一声提示音。显示屏显示将音频路由到对讲机。
- 将发出一声提示音。显示屏显示将音频路由到蓝牙。



查看设备详情



按照步骤在对讲机上查看设备详情。

1 按  访问菜单。

2 按  或  显示蓝牙。按  进行选择。

3 按  或  显示设备。按  进行选择。



4 按  或  显示所需的设备。按  进行选择。



5 按  或  显示查看详情。按  进行选择。



删除设备名称



您可从蓝牙设备列表中删除已断开连接的设备。

1 按  访问菜单。

2 按  或  显示蓝牙。按  进行选择。









3 按  或  显示设备。按  进行选择。

4 按  或  显示所需的设备。按  进行选择。

- 5 按  或  显示删除。按  进行选择。屏幕显示已删除设备。

蓝牙麦克风增益

此功能允许用户控制已连接的蓝牙功能设备的麦克风增益值。

- 1 按  访问菜单。
- 2 按  或  显示蓝牙。按  进行选择。
- 3 按  或  显示蓝牙麦克风增益。按  进行选择。
- 4 按  或  至蓝牙麦克风增益类型和当前值。按  进行选择。您可以在此处编辑值。
- 5 按  或  增加或减少值。按  进行选择。

室内定位



说明:

室内定位功能适用于具有最新软件和硬件的型号。请联系您的经销商或系统管理员了解详情。

室内定位用于跟踪对讲机用户的位置。启用室内定位时，对讲机处于受限制可发现模式。专用的信标用于定位对讲机并确定其位置。

打开或关闭室内定位

您可以通过执行以下操作之一打开或关闭室内定位。

- 通过菜单访问此功能。
 - a. 按  访问菜单。
 - b. 按  或  至蓝牙，然后按  进行选择。
 - c. 按  或  至室内定位，然后按  进行选择。
 - d. 按  打开室内定位。
显示屏显示室内定位开。您会听到一声确定提示音。

会发生以下情况之一。

- 如果成功，“室内定位可用”图标出现在主屏幕显示屏上。
- 如果失败，显示屏显示打开失败。您会听到一声否定提示音。

e. 按  关闭室内定位。

显示屏显示室内定位关。您会听到一声确定提示音。
会发生以下情况之一。

- 如果成功，“室内定位可用”图标在主屏幕显示屏上消失。
- 如果失败，显示屏显示关闭失败。您会听到一声否定提示音。

- 使用预设按钮访问此功能。

a. 长按预设的**室内定位**按钮，打开室内定位。

显示屏显示室内定位开。您会听到一声确定提示音。
会发生以下情况之一。

- 如果成功，“室内定位可用”图标出现在主屏幕显示屏上。

- 如果失败，显示屏显示打开失败。如果失败，您将听到一声否定提示音。

b. 按预设的**室内定位**按钮，关闭室内定位。



显示屏显示室内定位关。您会听到一声确定提示音。
会发生以下情况之一。



- 如果成功，“室内定位可用”图标在主屏幕显示屏上消失。
- 如果失败，显示屏显示关闭失败。如果失败，您将听到一声否定提示音。



访问室内定位信标信息

按照步骤访问室内定位信标信息。

1 按  访问菜单。

2 按  或  至蓝牙，然后按  进行选择。

3 按  或  至室内定位，然后按  进行选择。

- 4 按  或  至信标，然后按  进行选择。

屏幕显示信标信息。

通知列表

您的对讲机上有一个通知列表，该列表收集了信道上的所有未读事件，例如未读的短信、遥感遥测信息、未接呼叫和呼叫提示。

当通知列表中有一个或多个事件时，显示屏显示**通知**图标。

该列表支持最多 **40** 个未读事件。当列表已满时，下一个事件会自动替换最早的事件。当读取了某个事件后，该事件会从通知列表中移除。



对于短信、未接来电和呼叫提示事件，通知的最大数量为 **30** 条短信和 **10** 个未接呼叫或呼叫提示。此最大数量取决于各个功能（任务、短信或未接来电或呼叫提示）列表功能。

访问通知列表

按照步骤访问对讲机上的通知列表。

- 1 按  访问菜单。

- 2 按  或  显示通知。按  进行选择。

- 3 按  或  显示所需的事件。按  进行选择。

长按  返回主屏幕。

自动范围应答机系统

自动范围应答机系统 (ARTS) 是一种仅限模拟的功能，专用于在对讲机超出其他配备 ARTS 的对讲机的范围时通知您。

配备 ARTS 的对讲机定期传输或接收信号，以确认对讲机位于彼此范围之内。

您的对讲机提供如下指示状态：

首次提示

将发出一声提示音。

显示屏在信道别名后显示在范围中。

ARTS 在范围中提示

发出提示音（如果预设）。

显示屏在信道别名后显示在范围中。

ARTS 不在信号区提示

将发出一声提示音。LED 红灯快速闪烁。

显示屏交替显示超出范围和主屏幕。



说明：
请联系您的经销商或系统管理员了解详情。

无线编程

您的经销商可通过不带任何物理连接的无线编程 (OTAP) 远程更新您的对讲机。此外，某些设置还可使用 OTAP 配置。

当对讲机进行 OTAP 时，绿色 LED 闪烁。

当对讲机接收大批量数据时：

- 显示屏显示**大批量数据**图标。
- 信道变得繁忙。
- 如果您按 **PTT** 按钮，将发出一声否定提示音。

当 OTAP 完成时，根据配置：

- 将发出一声提示音。显示屏显示更新重启。对讲机将通过关机并再次打开来重新启动。
- 您可以选择立即重启或推迟。选择推迟时，您的对讲机将返回到前一屏幕。显示屏显示 **OTAP 延迟计时器** 图标，直到发生自动重新启动。

当对讲机在自动重新启动后通电：

- 如果成功，显示屏显示软件更新完成。

- 如果失败，显示屏显示软件更新失败。

有关已更新软件版本的信息，请参阅[检查软件更新信息 \(第 176 页\)](#)。

禁止发射

“禁止发射”功能允许用户阻止来自对讲机的所有发射。





说明：
蓝牙和 Wi-Fi 功能可用于“禁止发射”模式。

启用禁止发射

按照步骤启用禁止发射。

执行下列其中一项操作：

- 按  或  至禁止发射，然后按  进行选择。
- 按**禁止发射**可预设按钮。

- 发出一声确定提示音。
- 屏幕显示禁止发射打开。





说明：
发射禁止状态在对讲机打开前不更改。

禁用禁止发射

按照步骤禁用禁止发射。

执行下列其中一项操作：



- 按  或  至禁止发射，然后按  进行选择。
 - 按 **禁止发射** 可预设按钮。
-
- 发出一声否定提示音。发射返回至正常操作模式。
 - 屏幕显示禁止发射关闭。



选择第三方外围设备连接模式



按照步骤选择下面的第三方外围设备连接模式之一：



- Motorola Solutions
- PC 和音频
- 数据附件
- 遥感遥测
- 通用

- 按  访问菜单。
-

- 按  或  显示设置。按  进行选择。
-

- 按  或  显示对讲机设置。按  进行选择。
-

- 按  或  显示电缆类型。按  进行选择。
-

- 按  或  显示所需的连接模式。按  进行选择。

屏幕显示选定的连接模式。屏幕将返回上一级菜单。



接收信号强度指示

此功能允许您查看接收信号强度指示 (RSSI) 值。

显示屏右上角显示 **RSSI** 图标。有关 **RSSI** 图标的更多信息，请参见[显示屏图标](#)。

查看 RSSI 值

将四向导航键盘麦克风（Motorola Solutions 部件号 RMN5127_）连接至对讲机。

在主屏幕中，使用四向导航键盘麦克风，按  三次并立即按  三次。

屏幕显示当前 RSSI 值。

要返回主屏幕，请按住 。

开机密码功能

此功能允许您通过在打开设备时询问密码来限制对讲机的访问。

您可以使用键盘麦克风或向上/向下滚动按钮来输入密码。

使用密码访问对讲机

按照步骤使用密码访问对讲机。



1 输入当前的四位数密码。



说明：

使用**紧急呼叫**脚踏开关取消密码输入，可以访问对讲机。

- 使用键盘麦克风。

- 按  或  编辑每个数位的数值，然后按  进入并移至下一数位。

2 按  输入密码。

如果成功，则对讲机将开机。

如果失败：

- 尝试第一次和第二次后，显示屏显示密码错误。重复**步骤 1**。
- 尝试第三次后，显示屏显示密码错误，然后显示对讲机已锁定。将发出一声提示音。黄色 LED 指示灯双闪。对讲机进入锁定状态持续 15 分钟。



说明：

在锁定状态下，对讲机仅对**开/关/音量控制旋钮**和预设的**背光**按钮的输入作出响应。

解除对讲机锁定状态

在锁定状态下，您的对讲机无法接收呼叫。按照步骤解锁处于锁定状态的对讲机。



执行以下操作之一：

- 如果对讲机已开机，请等待 15 分钟，然后重复 [使用密码访问对讲机 \(第 147 页\)](#) 中的步骤以访问对讲机。
- 如果对讲机已关机，请将对讲机开机。您的对讲机将重新启动计时器，锁定 15 分钟。将发出一声提示音。黄色 LED 指示灯双闪。显示屏将显示对讲机已锁定。
等待 15 分钟，然后重复 [使用密码访问对讲机 \(第 147 页\)](#) 中的步骤以访问对讲机。

打开或关闭开机密码

按照步骤打开或关闭对讲机上的密码锁。

- 1 按  访问菜单。
- 2 按  或  显示设置。按  进行选择。
- 3 按  或  显示对讲机设置。按  进行选择。
- 4 按  或  显示开机密码。按  进行选择。

- 5 输入当前的四位数密码。
 - 使用键盘麦克风。
 - 按  或  编辑每个数位的数值，然后按  进入并移至下一数位。
每输入一位密码时，您都会听到一声确定提示音。

- 6 按  输入密码。
如果密码不正确，显示屏会显示密码错误，并自动返回上一级菜单。

- 7 执行以下操作之一：
 - 按  或  显示打开。按  进行选择。
显示屏在打开旁显示 。
 - 按  或  显示关闭。按  进行选择。
显示屏在关闭旁显示 。

更改密码

按照步骤更改对讲机上的密码。

- 1 按  访问菜单。

- 2 按  或  显示设置。按  进行选择。

- 3 按  或  显示对讲机设置。按  进行选择。

- 4 按  或  显示开机密码。按  进行选择。

- 5 输入当前的四位数密码，然后按  继续。
如果密码不正确，显示屏会显示密码错误，并自动返回上一级菜单。

- 6 按  或  显示改变开机密码。按  进行选择。

- 7 输入一个新的四位数密码，然后按  继续。

- 8 重新输入新的四位数密码，然后按  继续。

如果成功，显示屏显示密码更改成功。

如果失败，显示屏显示密码不匹配。

屏幕自动返回上一级菜单。

前面板配置



您可在前面板配置 (FPC) 中自定义某些功能参数，以增强您的对讲机的用途。



进入前面板配置模式

按照步骤在对讲机上进入前面板编程模式。

在任何时候长按  都可以返回主屏幕。





- 1 按  访问菜单。

- 2 按  或  显示设置。按  进行选择。

- 3 按  或  显示对讲机配置。按  进行选择。

编辑 FPP 模式参数

根据需要使用以下按钮，以便浏览各个功能参数。

- ， - 滚动浏览各个选项、增加/减小数值或垂直浏览。
-  - 选择选项或进入子菜单。
-  - 短按返回上一菜单或退出选择屏幕。长按返回主屏幕。

Wi-Fi 操作

此功能允许您设置和连接至 Wi-Fi 网络。Wi-Fi 支持更新对讲机固件、Codeplug 和资源，例如语言包和语音提示。



说明：

此功能仅适用于 XiR M8668i/CM7668i。

Wi-Fi® 是 Wi-Fi Alliance® 的注册商标。

对讲机支持 WEP/WPA/WPA2-个人和 WPA/WPA2-企业 Wi-Fi 网络。

WEP/WPA/WPA2-个人 Wi-Fi 网络

使用基于预共享密钥（密码）的身份验证。

预共享密钥可使用菜单或 CPS/对讲机管理输入。

WPA/WPA2-企业 Wi-Fi 网络

使用基于证书的身份验证。

对讲机必须预配置有证书。



说明：

要连接到 WPA/WPA2-企业 Wi-Fi 网络，请咨询经销商或系统管理员。

预设的**打开或关闭 Wi-Fi**按钮由您的经销商或系统管理员分配。咨询经销商或系统管理员以确定对讲机的预设情况。

预设的**打开或关闭 Wi-Fi**按钮的语音提示可以根据用户要求，通过 CPS 自定义。请联系您的经销商或系统管理员了解详情。



说明：

您可以使用监控对讲机远程打开或关闭 Wi-Fi（请参阅[使用监控对讲机打开或关闭 Wi-Fi](#)）。请联系您的经销商或系统管理员了解详情。

打开或关闭 Wi-Fi

按照步骤打开或关闭 Wi-Fi。

- 1 按预设的**打开或关闭 Wi-Fi** 按钮。语音提示会发出：
打开或关闭 Wi-Fi。

- 2 使用菜单访问此功能。
 - a 按  访问菜单。
 - b 按  或  显示 WiFi，然后按  进行选择。
 - c 按  或  显示 WiFi 开和按  进行选择。
 - d 按  以打开/关闭 Wi-Fi。

如果 Wi-Fi 处于打开状态，屏幕将在已启用旁边显示 。

如果 Wi-Fi 处于关闭状态， 将从已启用旁边消失。

使用指定的对讲机（单独控制）远程打开或关闭 Wi-Fi

进行单独控制（一对一）时，请按照下面的过程操作，远程打开或关闭 Wi-Fi。



说明：

具有特定 CPS 设置的对讲机才支持此功能，请联系您的经销商或系统管理员了解更多信息。

- 1 执行以下操作之一：
 - 长按可预设按钮。使用键盘输入 ID，并按  进行选择。继续 [步骤 3](#)。
 - 按  访问菜单。

- 2 按  或  显示通讯录和按  进行选择。

- 3 按  或  至 WiFi 控制，然后按  进行选择。

- 4 按  或  以选择开或关。

- 5 按  进行选择。

如果成功，显示屏显示肯定的小型通知。

如果不成功，显示屏显示否定性的小型通知。

使用指定的对讲机（通话组控制）远程打开或关闭 Wi-Fi

进行通话组控制（一对多）时，请按照下面的过程操作，远程打开或关闭 Wi-Fi。



说明：

具有特定 CPS 设置的对讲机才支持此功能，请联系您的经销商或系统管理员了解更多信息。

- 1 按  访问菜单。

- 2 按  或  显示通讯录和按  进行选择。

- 3 按  或  选择所需的用户别名或 ID。

- 4 按  或  至 WiFi 控制，然后按  进行选择。

- 5 按  或  以选择开或关。

- 6 按  进行选择。

如果成功，显示屏显示发送成功。

如果不成功，显示屏显示否定性的小型通知。

连接到网络接入点

当您打开 Wi-Fi 时，对讲机扫描并连接到网络接入点。



说明：



您也可以使用菜单连接到网络接入点。

WPA-企业 Wi-Fi 网络接入点可预配置。咨询经销商或系统管理员以确定对讲机的预设情况。

- 1 按  访问菜单。

- 2 按  或  显示 WiFi，然后按  进行选择。



- 3 按  或  显示网络，然后按  进行选择。

- 4 按  或  显示一个网络接入点，然后按  进行选择。



说明:

对于 WPA-企业 Wi-Fi，如果未预配置网络接入点，则连接选项不可用。

- 5 按  或  显示连接，然后按  进行选择。

- 6 对于 WPA-个人 Wi-Fi，输入密码并按  。

- 7 对于 WPA-企业 Wi-Fi，密码可使用对讲机管理进行配置。

如果预配置的密码正确，则对讲机会自动连接到选定的网络接入点。

如果预配置的密码不正确，显示屏会显示身份验证失败，并自动返回到上一级菜单。

如果连接成功，对讲机会显示一条通知并将网络接入点保存到配置文件列表中。

如果连接失败，对讲机显示屏会短暂显示故障通知屏幕并自动返回到上一级菜单。

检查 Wi-Fi 连接状态

按照步骤检查 Wi-Fi 连接状态。

按预设的 **Wi-Fi 状态查询**按钮，使用语音提示了解连接状态。语音提示发出：**Wi-Fi 关闭**、**Wi-Fi 打开但未建立连接**，或 **Wi-Fi 打开并建立连接**。

- 关闭 Wi-Fi 时，显示屏显示 Wi-Fi 关。
- 对讲机连接至网络时，显示屏显示 Wi-Fi 开，已连接。
- Wi-Fi 打开但对讲机未连接至任何网络时，显示屏显示 Wi-Fi 开，连接断开。

Wi-Fi 状态查询结果的语音提示可以根据用户要求，通过 CPS 自定义。请联系您的经销商或系统管理员了解详情。









说明:

预设的 **Wi-Fi 状态查询**按钮由您的经销商或系统管理员分配。咨询经销商或系统管理员以确定对讲机的预设情况。



刷新网络列表

按照步骤刷新网络列表。

- 通过菜单执行以下操作以刷新网络列表。

- a. 按  访问菜单。
- b. 按  或  显示 WiFi，然后按  进行选择。
- c. 按  或  显示网络，然后按  进行选择。
当您进入“网络”菜单时，对讲机将自动刷新网络列表。

- 如果您已在“网络”菜单中，请执行以下操作以刷新网络列表。

按  或  至刷新，然后按  进行选择。

对讲机将刷新并显示最新的网络列表。

添加网络



说明:

此任务不适用于 WPA-企业 Wi-Fi 网络。

如果首选网络不在可用网络列表中，请执行以下操作以添加网络。

- 1 按  访问菜单。

- 2 按  或  显示 WiFi，然后按  进行选择。

- 3 按  或  显示网络，然后按  进行选择。

- 4 按  或  至添加网络，然后按  进行选择。

- 5 输入服务集标识符 (SSID)，然后按  。

- 6 按  或  至打开，然后按  进行选择。

- 7 输入密码并按  。

对讲机将显示确定性的小型通知，指明已成功保存网络。

查看网络接入点的详细信息

您可以查看网络接入点的详细信息。

- 1 按  访问菜单。

- 2 按  或  显示 WiFi，然后按  进行选择。

- 3 按  或  显示网络，然后按  进行选择。

- 4 按  或  显示一个网络接入点，然后按  进行选择。

- 5 按  或  至查看详情，然后按  进行选择。



说明：

WPA-个人 Wi-Fi 和 WPA-企业 Wi-Fi 显示网络接入点的不同详细信息。

WPA-个人 Wi-Fi

对于已连接的网络接入点，对讲机显示服务集标识符 (SSID)、安全模式、媒体访问控制 (MAC) 地址和互联网协议 (IP) 地址。

对于未连接的网络接入点，对讲机显示 SSID 和安全模式。

WPA-企业 Wi-Fi

对于已连接的网络接入点，对讲机显示 SSID、安全模式、身份、扩展身份验证协议 (EAP) 方法、阶段 2 身份验证、证书名称、MAC 地址、IP 地址、网关、DNS1 和 DNS2。

对于未连接的网络接入点，对讲机显示 SSID、安全模式、身份、EAP 方法、阶段 2 身份验证和证书名称。

删除网络接入点









说明：



此任务不适用于企业 Wi-Fi 网络。

请执行以下操作以从配置文件列表中删除网络接入点。



- 1 按  访问菜单。

2 按  或  显示 WiFi，然后按  进行选择。

3 按  或  显示网络，然后按  进行选择。

4 按  或  至所选网络接入点，然后按  进行选择。

5 按  或  至删除，然后按  进行选择。

6 按  或  至是，然后按  进行选择。
对讲机将显示确定性的小型通知，指明已成功删除所选的网络接入点。

实用工具

本章介绍对讲机中可用的实用功能操作。

降噪级别

您可以调整对讲机的降噪级别，过滤低信号强度的无用呼叫或噪声高于正常背景的信道。

普通

这是默认设置。

严格

该设置过滤无用呼叫和/或背景噪声。来自远程位置的呼叫也可能被过滤掉。



说明:



此功能不适用于频率相同的民用频段信道。



设置降噪水平

按照步骤在对讲机上设置降噪级别。

1 执行以下操作之一：





- 按下预设的**降噪**按钮。跳过以下步骤。
- 按  访问菜单。





2 按  或  显示设置。按  进行选择。

3 按  或  显示对讲机设置。按  进行选择。

4 按  或  显示降噪。按  进行选择。

5 执行以下操作之一：

- 按  或  显示正常。按  进行选择。
显示屏在正常旁边显示 。

- 按  或  显示严格。按  进行选择。
显示屏在严格旁边显示 。

屏幕自动返回上一级菜单。

功率级别

您可以将每个信道的功率设置自定义为高或低。

高

该设置用于与距离相对较远的对讲机进行通信。

低

该设置用于与较近处的对讲机进行通信。



说明：



此功能不适用于频率相同的民用频段信道。



设置功率级别



按照步骤在对讲机上设置功率级别。

1 执行以下操作之一：





- 按下预设的**功率级别**按钮。跳过以下步骤。
- 按  访问菜单。





2 按  或  显示设置。按  进行选择。

3 按  或  显示对讲机设置。按  进行选择。

4 按  或  显示功率。按  进行选择。

5 执行以下操作之一：

- 按  或  显示高。按  进行选择。
显示屏在高旁边显示 。



- 按  或  显示低。按  进行选择。显示屏在低旁边显示 。



- 6 长按  返回主屏幕。



打开或关闭对讲机音调/提示



如果需要，您可以启用和禁用所有对讲机提示音和提示，但传入紧急呼叫提示音除外。按照步骤打开或关闭对讲机上的音调和提示。



- 1 执行以下操作之一：
 - 按预设的**提示音/提示**按钮。跳过以下步骤。
 - 按  访问菜单。

- 2 按  或  显示设置。按  进行选择。

- 3 按  或  显示对讲机设置。按  进行选择。

- 4 按  或  显示音调/提示。按  进行选择。



- 5 按  或  显示全部音调。按  进行选择。



- 6 按  以启用或禁用全部音调和提示。屏幕将显示以下结果之一：
 - 如果启用，已启用旁出现 。
 - 如果禁用，已启用旁的  消失。



打开或关闭键盘音

按照步骤打开或关闭对讲机的键盘音。

- 1 按  访问菜单。



- 2 按  或  显示设置。按  进行选择。

- 3 按  或  显示对讲机设置。按  进行选择。

4 按  或  显示音调/提示。按  进行选择。

5 按  或  显示键盘音。按  进行选择。



6 按  启用或禁用键盘音。屏幕将显示以下结果之一：



- 如果启用，已启用旁出现 。
 - 如果禁用，已启用旁的  消失。
-



设置音调/提示音量偏移度



此功能调节提示音或提示的音量，允许它比语音音量高一些或低一些。按照步骤在对讲机上设置提示音和提示的音量偏移度。



1 按  访问菜单。

2 按  或  显示设置。按  进行选择。



3 按  或  显示对讲机设置。按  进行选择。

4 按  或  显示音调/提示。按  进行选择。

5 按  或  显示音量偏移。按  进行选择。

6 按  或  显示所需的音量偏移度。
反馈提示音随每个相应的音量偏移度响起。

7 执行以下操作之一：

- 按  进行选择。已保存所需的音量偏移度。
 - 按  退出。放弃更改。
-

打开或关闭通话许可提示音

按照步骤打开或关闭对讲机的通话许可提示音。

- 1 按  访问菜单。

- 2 按  或  显示设置。按  进行选择。

- 3 按  或  显示对讲机设置。按  进行选择。

- 4 按  或  显示音调/提示。按  进行选择。

- 5 按  或  显示通话许可。按  进行选择。

- 6 按  启用或禁用通话许可音。
屏幕将显示以下结果之一：
 - 如果启用，已启用旁出现 。
 - 如果禁用，已启用旁的  消失。

打开或关闭开机音

按照步骤打开或关闭对讲机的开机音。

- 1 按  访问菜单。

- 2 按  或  显示设置。按  进行选择。

- 3 按  或  显示对讲机设置。按  进行选择。

- 4 按  或  显示音调/提示。按  进行选择。

- 5 按  或  显示电源开。按  进行选择。

- 6 按  启用或禁用开机提示音。屏幕将显示以下结果之一：
 - 如果启用，已启用旁出现 。
 - 如果禁用，已启用旁的  消失。

设置短信提示音

您可以将通讯录列表中各条目的短信提示音自定义为瞬间音或重复音。按照步骤在对讲机上设置短信提示音。

- 1 按  访问菜单。

- 2 按  或  显示通讯录。按  进行选择。

- 3 按  或  显示所需的别名或 ID。按  进行选择。

- 4 按  或  显示短信提示音。按  进行选择。

- 5 执行以下操作之一：
 - 按  或  显示瞬间。按  进行选择。
显示屏在瞬间旁边显示 。
 - 按  或  显示重复。按  进行选择。
显示屏在重复旁边显示 。

更改显示模式



您可以根据需要将对讲机的显示模式更改为日间显示模式或夜间显示模式。该功能将影响屏幕的颜色配置。按照步骤更改对讲机显示模式。

- 1 执行以下操作之一：
 - 按预设的**显示模式**按钮。跳过以下步骤。
 - 按  访问菜单。

- 2 按  或  显示设置。按  进行选择。

- 3 按  或  显示对讲机设置。按  进行选择。

- 4 按  或  至显示。按  进行选择。
屏幕显示日间模式和夜间模式。

- 5 按  或  显示所需的设置。按  进行选择。
显示屏在所选的设置旁显示 。

调节显示屏亮度

按照步骤在对讲机上调节显示屏亮度。激活“自动亮度”时，无法调节屏幕亮度。

1 执行以下操作之一：

- 按预设的**亮度**按钮。跳过以下步骤。
- 按  访问菜单。

2 按 或 显示设置。按 进行选择。

3 按 或 显示对讲机设置。按 进行选择。

4 按 或 显示亮度。按 进行选择。 显示屏显示进度条。

5 按 或 显示降低或增加显示屏亮度。按 进行选择。 设置值的范围为 1 到 8。

打开/关闭喇叭/灯

对讲机可通过喇叭和灯光功能做出呼入电话提示。激活时，呼入电话使喇叭响起并打开车辆上的指示灯。该功能需要由您的经销商通过对讲机后部的附件接口来安装。按照步骤打开或关闭对讲机上的所有喇叭和指示灯。

1 执行以下操作之一：

- 按预设的**喇叭/灯**按钮。跳过以下步骤。
- 按  访问菜单。

2 按 或 显示设置。按 进行选择。

3 按 或 显示对讲机设置。按 进行选择。

4 按 或 显示喇叭/灯。按 进行选择。

5 按 启用/禁用喇叭/灯。屏幕将显示以下结果之一：

- 如果启用，已启用旁出现  。

- 如果禁用，已启用旁的 ✓ 消失。





打开或关闭 LED 指示灯

按照步骤打开或关闭对讲机上的 LED 指示灯。

- 1 按  访问菜单。
- 2 按  或  显示设置。按  进行选择。
- 3 按  或  显示对讲机设置。按  进行选择。
- 4 按  或  显示 LED 指示灯。按  进行选择。
- 5 按  启用或禁用 LED 指示灯。
屏幕将显示以下结果之一：
 - 如果启用，已启用旁出现 ✓。
 - 如果禁用，已启用旁的 ✓ 消失。

打开或关闭公共广播系统



按照步骤来启用或禁用您的对讲机的内部公共广播 (PA) 系统。



- 1 执行以下操作之一：
 - 按预设的**公共广播**按钮。跳过以下步骤。
 - 按  访问菜单。
- 2 按  或  显示设置。按  进行选择。
- 3 按  或  显示对讲机设置。按  进行选择。
- 4 按  或  显示公共广播。按  进行选择。
- 5 按  以启用或禁用公共广播。
 - 如果启用，已启用旁出现 ✓。
 - 如果禁用，已启用旁的 ✓ 消失。



打开或关闭外部公共广播系统



按照步骤来启用或禁用您的对讲机的外部公共广播 (PA) 系统。

- 1 执行以下操作之一：
 - 按预设的**外部公共广播**按钮。跳过以下步骤。
 - 按  访问菜单。

- 2 按  或  显示设置。按  进行选择。

- 3 按  或  显示对讲机设置。按  进行选择。

- 4 按  或  显示外部公共广播。按  进行选择。

- 5 按  启用或禁用外部公共广播。
 - 如果启用，已启用旁出现 。
 - 如果禁用，已启用旁的  消失。

打开或关闭开机界面

您可按照步骤启用和禁用开机界面。

- 1 按  访问菜单。

- 2 按  或  显示设置。按  进行选择。

- 3 按  或  显示对讲机设置。按  进行选择。

- 4 按  或  显示显示。按  进行选择。

- 5 按  或  显示开机界面。按  进行选择。

- 6 按  启用或禁用开机界面。
屏幕将显示以下结果之一：
 - 如果启用，已启用旁出现 。
 - 如果禁用，已启用旁的  消失。

设置语言

按照步骤在对讲机上设置语言。

- 1 按  访问菜单。

- 2 按  或  显示设置。按  进行选择。

- 3 按  或  显示对讲机设置。按  进行选择。

- 4 按  或  显示语言。按  进行选择。

- 5 按  或  显示所需的语言。按  进行选择。
显示屏在所选语言旁边显示 。

识别线缆类型

执行以下步骤以选择对讲机使用的线缆类型。

- 1 按  访问菜单。

- 2 按  或  显示设置。按  进行选择。

- 3 按  或  显示对讲机设置。按  进行选择。

- 4 按  或  显示线缆类型。按  进行选择。

- 5 当前线缆类型以  表示。

声控发射

声控发射 (VOX) 允许您在预设的信道上发起免提语音激活的呼叫。只要具备声控发射功能的附件上的麦克风检测到语音，对讲机就会自动发射，并在预设的时间内保持发射。



说明:

此功能不适用于频率相同的民用频段信道。

通过执行以下一项操作可启用或禁用声控发射：

- 关闭并重新打开对讲机可启用声控发射。
- 使用**向上/下滚动**按钮更改信道以启用声控发射。
- 使用**音量/信道旋钮**更改信道以启用声控发射。
- 使用预设的 **VOX** 按钮或菜单打开或关闭声控发射可启用或禁用声控发射。
- 在对讲机操作过程中按 **PTT** 按钮可禁用声控发射。



说明：



打开或关闭此功能仅限于已启用此功能的对讲机。请联系您的经销商或系统管理员了解详情。



打开或关闭声控发射



按照步骤开启或关闭对讲机上的 **VOX**。

1 执行以下操作之一：

- 按预设的 **VOX** 按钮。跳过以下步骤。
- 按  访问菜单。

2 按  或  显示设置。按  进行选择。

3 按  或  显示对讲机设置。按  进行选择。

4 按  或  显示声控发射。按  进行选择。

5 按  启用或禁用 **VOX**。



说明：

如果已启用通话许可提示音，使用触发词语可发起呼叫。等待通话许可提示音结束，然后对着麦克风清晰地讲话。有关详细信息，请参阅[打开或关闭通话许可提示音 \(第 162 页\)](#)。

打开或关闭语音提示

此功能使对讲机可以通过语音方式指示用户刚刚分配的当前区域或信道或者用户刚按下的可编程按钮。当用户难以阅读屏幕上显示的内容时，此功能通常非常有用。

可根据客户需求对此语音提示进行自定义。按照步骤打开或关闭对讲机的语音提示。

打开或关闭选件板

可将每个信道中的选件板功能分配给可预设按钮。一个信道可以支持多达 6 个选件板功能。按照步骤打开或关闭对讲机上的选件板。

按下预设的**选件板**按钮。

文本转语音

文本转语音功能仅能由您的经销商或系统管理员启用。如果文本转语音已启用，则语音提示功能会自动被禁用。如果语音提示已启用，那么将自动禁用文本转语音功能。

此功能让对讲机可以通过语音方式指示以下功能：

- 当前信道
- 当前区域
- 打开或关闭预设的按钮功能
- 收到的短信的内容
- 收到的任务的内容

此音频指示器可根据客户需求进行自定义。当用户难以阅读屏幕上显示的内容时，此功能通常非常有用。

设置文本转语音

按照步骤设置文本转语音功能。

- 1 按  访问菜单。



- 2 按  或  显示设置。按  进行选择。

- 3 按  或  显示对讲机设置。按  进行选择。

- 4 按  或  显示语音提示。按  进行选择。

- 5 按  或  显示以下任何功能。按  进行选择。
可用功能如下所示：
 - 全部
 - 信息
 - 任务
 - 信道

- 区域
- 编程按钮
- ✓ 出现在所选设置旁边。

- 按  或  禁用呼叫转移。如果禁用，已启用旁的 ✓ 消失。

打开或关闭自动呼叫转移

您可以使您的对讲机自动将语音呼叫转发给另一对讲机。

- 1 按  访问菜单。
- 2 按  或  显示设置。按  进行选择。
- 3 按  或  显示对讲机设置。按  进行选择。
- 4 按  或  显示呼叫转移。按  进行选择。
- 5 执行以下操作之一：
 - 按  或  启用呼叫转移。如果启用，已启用旁出现 ✓。

设置菜单计时器

您可以设置对讲机在自动切换至主屏幕前在菜单中所停留的时间。按照步骤设置菜单计时器。

- 1 按  访问菜单。
- 2 按  或  显示设置。按  进行选择。
- 3 按  或  显示对讲机设置。按  进行选择。
- 4 按  或  至显示。按  进行选择。
- 5 按  或  至菜单限时器。按  进行选择。
- 6 按  或  显示所需的设置。按  进行选择。

打开或关闭模拟麦克风 AGC

在模拟系统中发射信号时，模拟麦克风自动增益控制 (AGC) 自动控制对讲机的麦克风增益。

此功能会抑制高频或提升低频以将音频保持在预设的值，从而实现一致的音频水平。按照步骤打开或关闭对讲机上的模拟麦克风 AGC。

- 1 按  访问菜单。

- 2 按  或  显示设置。按  进行选择。

- 3 按  或  显示对讲机设置。按  进行选择。

- 4 按  或  显示麦克风 AGC-A。按  进行选择。

- 5 按  启用或禁用模拟麦克风 AGC。
屏幕将显示以下结果之一：
 - 如果启用，已启用旁出现 。

- 如果禁用，已启用旁的  消失。

打开或关闭数字麦克风 AGC

在数字系统中发射信号时，数字麦克风自动增益控制 (AGC) 自动控制对讲机的麦克风增益。

此功能会抑制高频或提升低频以将音频保持在预设的值，从而实现一致的音频水平。按照步骤打开或关闭对讲机上的数字麦克风 AGC。

- 1 按  访问菜单。

- 2 按  或  显示设置。按  进行选择。

- 3 按  或  显示对讲机设置。按  进行选择。

- 4 按  或  显示麦克风 AGC-D。按  进行选择。

- 5 按  启用或禁用数字麦克风 AGC。
屏幕将显示以下结果之一：

- 如果启用，已启用旁出现 ✓。
- 如果禁用，已启用旁的 ✓ 消失。







打开或关闭智能音频



您的对讲机会自动调整音量以克服环境中当前存在的背景噪音（包括静态和非静态噪音源）。此功能只对接收的音频有效，不会影响发射的音频。按照步骤打开或关闭对讲机上的智能音频。



说明：

此功能在进行蓝牙会话时不适用。

- 1 执行以下操作之一：
 - 按预设的**智能音频**按钮。跳过以下步骤。
 - 按  访问菜单。
- 2 按  或  显示设置。按  进行选择。
- 3 按  或  显示对讲机设置。按  进行选择。







- 4 按  或  显示智能音频。按  进行选择。



- 5 执行以下操作之一：

- 按  或  显示开。按  进行选择。显示屏在开旁边显示 ✓。
- 按  或  显示关。按  进行选择。显示屏在关旁边显示 ✓。



打开或关闭回声抑制器功能

通过此功能可以最小化您在接听电话时遇到的回声。按照步骤打开或关闭对讲机的回声抑制器。

- 1 按  访问菜单。
- 2 按  或  显示设置。按  进行选择。。
- 3 按  或  显示对讲机设置。按  进行选择。

4 按  或  显示 AF 抑制器。按  进行选择。

5 执行以下操作之一：



- 按 启用回声抑制器。如果启用，已启用旁出现 。
 - 按 禁用回声抑制器。如果禁用，已启用旁的  消失。
-



打开或关闭抖音增强功能



当您以包含许多唇齿抖音（卷舌“R”）发音的语言说话时，可以启用此功能。按照步骤打开或关闭对讲机上的抖音增强。

1 执行以下操作之一：

- 按预设的**抖音增强**按钮。跳过以下步骤。
 - 按  访问菜单。
-

2 按  或  显示设置。按  进行选择。

3 按  或  显示对讲机设置。按  进行选择。

4 按  或  显示抖音增强。按  进行选择。

5 执行以下操作之一：

- 按  或  显示开。按  进行选择。显示屏在开旁边显示 。
 - 按  或  显示关。按  进行选择。显示屏在关旁边显示 。
-

音频环境

您可以根据您的环境对您的对讲机的音频环境进行自定义。

默认

这是默认设置。

大声

该设置在嘈杂的环境中启用噪声抑制器，增加扬声器的音量。

工作组













该设置使用 **AF** 抑制器和禁用 **AGC**，适合彼此靠近的一组对讲机使用。

- 在嘈杂环境下使用时，选择响亮以增加扬声器的音量。
- 使用彼此靠近的一组对讲机时，选择工作组以减少回声。

显示屏在所选的设置旁显示 。

设置音频环境

根据环境，按照步骤在对讲机上设置音频环境。

- 按  访问菜单。
- 按  或  显示设置。按  进行选择。
- 按  或  显示对讲机设置。按  进行选择。
- 按  或  显示音频环境。按  进行选择。
- 按  或  显示所需的设置。按  进行选择。

这些设置如下。

- 选择默认使用默认工厂设置。

音频配置文件

您可以根据您的偏好对您的对讲机的音频配置文件进行自定义。

默认

这是默认设置。

级别 1、级别 2 和级别 3

这些设置旨在补偿噪音导致的 40、50、60 及以上年龄段成年人通常会有听力减退。



高音增强、中音增强和低音增强



这些设置旨在实现更微小的声音、鼻音更重的声音和更低沉的声音。



设置音频配置文件



按照步骤在对讲机上设置音频配置文件。

- 1 按  访问菜单。

- 2 按  或  显示设置。按  进行选择。

- 3 按  或  显示对讲机设置。按  进行选择。

- 4 按  或  显示音频配置文件。按  进行选择。

- 5 按  或  显示所需的设置。按  进行选择。

这些设置如下。

- 选择默认以禁用之前选定的音频配置文件并返回至默认工厂设置。
- 为音频配置文件选择级别 1、级别 2 或级别 3，旨在补偿 40 岁以上成人通常将面临的噪音导致的听力减退。

- 为音频配置文件选择高音增强、中音增强或低音增强，以便符合适用于尖细的声音、鼻音较重的声音和更深的声音的偏好。

显示屏在所选的设置旁显示 。

打开或关闭全球导航卫星系统



全球导航卫星系统 (GNSS) 是一种卫星导航系统，用于确定对讲机的精确位置。GNSS 包括全球定位系统 (GPS) 和 BeiDou 导航卫星系统 (BDS)。









说明：

所选型号的对讲机可提供 GPS 和 BDS。GNSS 卫星群可使用 CPS 配置。咨询经销商或系统管理员以确定对讲机的预设情况。

- 1 请执行以下步骤打开或关闭对讲机的 GNSS。
 - 按预设的 **GNSS** 按钮。
 - 按  访问菜单。继续下一步骤。

- 2 按  或  显示设置。按  进行选择。

3 按  或  显示对讲机设置。按  进行选择。



4 按  或  显示 GNSS。按  进行选择。

5 按  启用或禁用 GNSS。



如果启用，已启用旁出现 。

如果禁用，已启用旁的  消失。



• 按  访问菜单。

2 按  或  显示灵活 Rx 列表。按  进行选择。

3 执行以下操作之一：

• 按  或  显示打开。按  进行选择。
发出一声确定提示音。

显示屏显示确定性的小型通知。

• 按  或  显示关闭。按  进行选择。
发出一声否定提示音。

显示屏显示否定性的小型通知。

灵活接收列表

灵活接收列表是一项功能，使您可以创建和分配接收通话组列表上的成员。您的对讲机最多支持列表中的 16 个成员。此功能在智能信道共享模式下受支持。

打开或关闭灵活接收列表

按照步骤打开或关闭灵活接收列表。

1 执行以下操作之一：

• 按预设的**灵活接收列表**按钮。跳过以下步骤。

一般对讲机信息

对讲机包含有关各种常规参数的信息。

对讲机的一般信息如下所示：

- 对讲机别名和 ID。
- 固件和 Codeplug 版本。

- 软件更新。
- GNSS 信息。
- 站点信息。



说明:

按 返回前一屏幕。长按 返回主屏幕。不活动计时器超时后，对讲机退出当前屏幕。

查看对讲机别名和 ID

按照步骤查看对讲机上的对讲机别名和 ID。

1 执行以下操作之一：

- 按预设的**对讲机别名和 ID**按钮。跳过以下步骤。发出了一声确定提示音。

您可以按下预设的**对讲机别名和 ID**按钮以返回前一屏幕。

- 按 访问菜单。

2 按 或 显示设置。按 进行选择。

3 按 或 显示对讲机信息。按 进行选择。

4 按 或 显示我的 ID。按 进行选择。

第一行文字显示对讲机别名。第二行文字显示对讲机 ID。

检查固件版本和 Codeplug 版本

按照步骤检查对讲机上的固件版本和 Codeplug 版本。

1 按 访问菜单。

2 按 或 显示设置。按 进行选择。

3 按 或 显示对讲机信息。按 进行选择。

- 4 按  或  显示版本。按  进行选择。
屏幕显示当前固件和 Codeplug 版本。
-

检查软件更新信息

此功能显示通过 OTAP 或 Wi-Fi 执行的最新软件更新的日期和时间。按照步骤检查对讲机上的软件更新信息。

- 1 按  访问菜单。
-
- 2 按  或  显示设置。按  进行选择。
-
- 3 按  或  显示对讲机信息。按  进行选择。
-
- 4 按  或  显示软件更新。按  进行选择。
屏幕显示最新软件更新的日期和时间。
-

软件更新菜单仅在至少进行一次成功的 OTAP 或 Wi-Fi 会话后才可用。有关详细信息，请参阅[无线编程 \(第 384 页\)](#)。

检查 GNSS 信息

在对讲机上显示 GNSS 信息，如以下值：

- 纬度
- 经度
- 高度
- 方向
- 速率
- 水平精度因子 (HDOP)
- 卫星
- 版本

- 1 按  访问菜单。
-
- 2 按  或  显示设置。按  进行选择。
-
- 3 按  或  显示对讲机信息。按  进行选择。
-
- 4 按  或  显示 GNSS 信息。按  进行选择。
-

- 按  或  显示所需的项目。按  进行选择。显示屏显示所请求的 **GNSS** 信息。

显示站点信息

按照步骤显示对讲机打开后当前站点的名称。

- 按  访问菜单。
- 按  或  显示设置。按  进行选择。
- 按  或  显示对讲机信息。按  进行选择。
- 按  或  显示站点信息。按  进行选择。

屏幕显示当前站点名称。

查看企业 Wi-Fi 证书详细信息

您可以查看选定企业 Wi-Fi 证书的详细信息。

- 按  访问菜单。
- 按  或  显示设置。按  进行选择。
- 按  或  至证书菜单。按  进行选择。
✓ 出现在就绪证书旁边。
- 按  或  显示所需证书。按  进行选择。

对讲机显示证书的完整详细信息。



说明:

对于未就绪证书，显示屏仅显示“状态”。

授权附件列表

Motorola Solutions 提供一系列附件以提高对讲机工作效率。

天线

- 组合 GNSS (GPS/Galileo/QZSS/GLONASS), UHF, 403-527 MHz, 2.0 dB 增益, 通孔安装, BNC (HAE6017_)
- 组合 GPS/UHF, 470 – 527 MHz, 1/4 波长, 通孔安装, BNC (HAE6018_)
- UHF, 403–527 MHz, 2.0 dB 增益, 通孔安装, BNC (HAE6021_)
- 组合 GPS/UHF, 494 – 512 MHz, 3.0 dB 增益, 通孔安装, BNC (HAE6023_)
- 组合 GPS/UHF, 470 – 494 MHz, 3.0 dB 增益, 通孔安装, BNC (HAE6025_)
- 800/900, 806-941 MHz, 短型, 通孔安装, Mini U (HAF4013_)
- 800/900, 806–941 MHz, 1/4 波长, 通孔安装, Mini-U (HAF4025_)
- 800/900, 806-941 MHz, 3dB 增益, 通孔安装, Mini U (HAF4026_)
- 800/900, 806–941 MHz, 5.0dB 增益, 通孔安装, Mini-U (HAF4027_)
- 组合 GPS+RF, 806–941 MHz, 1/4 波长, 通孔安装, Mini-U (HAF4029_)
- 组合 GPS+RF, 806–941 MHz, 3.0 dB 增益, 通孔安装, Mini-U (HAF4030_)
- 组合 GPS+RF, 806–941 MHz, 5.0 dB 增益, 通孔安装, Mini-U (HAF4032_)
- 组合 GPS+RF, 806–941 MHz, 5.0 dB 增益, 通孔安装, Mini-U (HAF4033_)
- UHF, 300-340 MHz, 1/4 波长, 通孔安装, BNC (PMAD4140_)
- 组合 GPS/GNSS/UHF, 350–400 MHz, 1/4 波长, 通孔安装, BNC (PMAD4102_)
- UHF, 350–400 MHz, 1/4 波长, 通孔安装, BNC (PMAD4107_)
- UHF, 320-360 MHz, 1/4 波长, 通孔安装, BNC (PMAD4141_)

- 组合 GNSS (GPS/Galileo/QZSS/GLONASS), UHF, 300-340 MHz, 1/4 波长, 通孔安装, BNC (PMAD4142_)
- 组合 GNSS (GPS/Galileo/QZSS/GLONASS), UHF, 320-360 MHz, 1/4 波长, 通孔安装, BNC (PMAD4143_)
- 组合 GNSS (GPS/Galileo/QZSS/GLONASS), UHF, 403-430 MHz, 1/4 波长, 通孔安装, BNC (PMAE4035_)
- 组合 GNSS (GPS/Galileo/QZSS/GLONASS), UHF, 406-420 MHz, 3.5 dB 增益, 通孔安装, BNC (PMAE4036_)
- 组合 GNSS (GPS/Galileo/QZSS/GLONASS), UHF, 450-470 MHz, 1/4 波长, 通孔安装, BNC (PMAE4037_)
- 组合 GNSS (GPS/Galileo/QZSS/GLONASS), UHF, 450-470 MHz, 5 dB 增益, 通孔安装, BNC (PMAE4038_)
- 固定安装 GPS 有源天线 (PMAN4000_)
- 车窗安装 GPS 有源天线 (PMAN4001_)
- 磁性安装 GPS 有源天线 (PMAN4002_)
- 组合 GNSS (GPS/Galileo/QZSS/BeiDou-2), NMO 安装基座, BNC (PMAN4003_)
- VHF, 136-144 MHz, 1/4 波长, 通孔安装, BNC (RAD4198_)
- VHF, 146-150.8 MHz, 1/4 波长, 通孔安装, BNC (RAD4199_)
- VHF, 150.8-162 MHz, 1/4 波长, 通孔安装, BNC (RAD4200_)
- VHF, 162-174 MHz, 1/4 波长, 通孔安装, BNC (RAD4201_)
- 组合 GNSS (GPS/Galileo/QZSS/GLONASS), VHF, 136-144 MHz, 1/4 波长, 通孔安装, BNC (RAD4219_)
- 组合 GNSS (GPS/Galileo/QZSS/GLONASS), VHF, 146-150.8 MHz, 1/4 波长, 通孔安装, BNC (RAD4220_)
- 组合 GNSS (GPS/Galileo/QZSS/GLONASS), VHF, 150.8-162 MHz, 1/4 波长, 通孔安装, BNC (RAD4221_)
- 组合 GNSS (GPS/Galileo/QZSS/GLONASS), VHF, 162-174 MHz, 1/4 波长, 通孔安装, BNC (RAD4222_)
- UHF, 403-430 MHz, 1/4 波长, 通孔安装, BNC (RAE4151_)
- UHF, 450-470 MHz, 1/4 波长, 通孔安装, BNC (RAE4152_)

- UHF, 450–470 MHz, 5.0 dB 增益, 通孔安装, BNC (RAE4154_)
- UHF, 406–420 MHz, 3.5dB 增益, 通孔安装, BNC (RAE4158_)

仅适用于与基座 **PMAN4003_** 一起使用：

- UHF, 494–512 MHz, 3.0 dB 增益, 通孔安装 (HAE6027_)
- UHF, 470–494 MHz, 3.0 dB 增益, 通孔安装 (HAE6028_)
- UHF, 403–527 MHz, 2.0 dB 增益, 通孔安装 (HAE6029_) (也适用于标准天线基座)
- UHF, 470–527 MHz, 1/4 波长, 通孔安装 (HAE6030_)
- UHF, 403–430 MHz, 1/4 波长 (PMAE4039_)
- UHF, 450–470 MHz, 1/4 波长 (PMAE4041_)
- UHF, 406–420 MHz, 3.5 dB 增益 (PMAE4040_)
- UHF, 450–470 MHz, 3.5 dB 增益 (PMAE4042_)
- UHF, 450–470 MHz, 5.0 dB 增益 (PMAE4043_)
- VHF, 162–174 MHz, 1/4 波长 (RAD4223_)
- VHF, 150.8–162 MHz, 1/4 波长 (RAD4224_)
- VHF, 146–150.8 MHz, 1/4 波长 (RAD4225_)

- VHF, 136–144 MHz, 1/4 波长 (RAD4226_)
- VHF, 146–172 MHz, 3.0 dB 增益 (RAD4227_)

音频附件

- HK200 蓝牙耳机, 美式插头 (89409N)
- HK200 蓝牙耳机, 英式插头 (ASMHK200VP-GB2A)
- HK200 蓝牙耳机, 欧式插头 (ASMHK200-GB3A)
- HK200 蓝牙耳机, 韩式插头 (ASMHK200-KR2A)
- HK200 蓝牙耳机, 中式插头 (ASMHK200-CN2A)
- HK200 蓝牙耳机, 澳式插头 (ASMHK200-AU2A)
- 电话型手持麦克风 (HMN4098_)
- 带 12 英寸电缆的关键作业无线耳机 (NNTN8125_)
- 带 9.5 英寸电缆的关键作业无线耳机 (NNTN8126_)
- 关键作业无线通话按键 POD (NNTN8127_)
- 非加密无线耳机和带有 PPT 音频的 PPT 设备, 12 英寸电缆 (NNTN8189_)
- 蓝牙附件套件, SP, 9.5 英寸电缆 (NNTN8190_)
- 无线私密套件, 包括两套双线耳塞 (1 个黑色和 1 个白色), 单线耳塞 (黑色) 和一个 3.5 毫米适配器, 可插入任何现有耳机 (NNTN8296_)¹⁴

- 无线颈环 Y 形适配器和保持钩，适用于绝对极简型套件 (NNTN8385_) ¹⁶
- 企业无线附件包 (PMLN6463_)
- 无线 R2.17A 长距离远程扬声器麦克风 (PMMN4095_)
- 无线 R2.17 车载台麦克风网关 (PMMN4097_)
- 带悬臂式麦克风的灵活旋转耳机 (PMLN7181_) ¹⁶
- 带悬臂式麦克风和多件包装的灵活旋转耳机 (PMLN7203_) ¹⁶
- 绝对极简型耳机套件 (RLN4922_) ¹⁶
- XBT 颈带式非加密无线重型耳机 (RLN6490_)
- XBT 头戴式非加密无线重型耳机 (RLN6491_)
- 带线控麦克风的旋转耳机，适用于蓝牙附件套件 Pod，3 件装 (RLN6550_) ¹⁶
- 桌面麦克风 (RMN5050_)
- 紧凑型麦克风 (RMN5052_)
- IMPRES 4 向键盘麦克风 (RMN5127_)
- 带增强声音的重型麦克风 (RMN5053_)
- 带增强声音的遮阳板麦克风 (RMN5054_)

电缆

- 紧凑型麦克风更换电缆 (3075336B07)
- 重型/键盘型麦克风更换电缆 (3075336B10)
- 连接电池的电源线，10 英尺（3 米）电缆，15 安培（1 – 25 瓦）(HKN4137_)
- 连接电池的电源线，10 英尺（3 米）电缆，20 安培（1 – 45 瓦）(HKN4191_)
- 连接电池的电源线，20 英尺（6 米）电缆，20 安培（1 – 45 瓦）(HKN4192_)
- 车载台前端 (MMP) 编程电缆 (HKN6184_)
- USB 编程电缆 (PMKN4010_)
- MAP 编程和测试电缆 (PMKN4016_)
- 车载台和中继器后端附件接口通用电缆 (PMKN4018_)
- 车载台麦克风延长电缆，10 英尺 (PMKN4033_)
- 车载台麦克风延长电缆，20 英尺 (PMKN4034_)
- 车载远程（3 米）电缆 (PMKN4143_)
- 车载远程（5 米）电缆 (PMKN4144_)
- 点火感应电缆 (RKN4136_)

¹⁴ 您的对讲机与此处所列附件兼容。有关详细信息，请咨询您的经销商。

桌上型附件

- 美国电源线 (3060665A04)
- GPN6145 对讲机电源线 (GKN6266_)
- 无扬声器的桌上型底盘 (GLN7318_)
- 开关电源 (1- 25 瓦型号) (CE 标识) (GPN6145_)
- 电源线 (HPN4007_)
- 电源 14 伏 15 安培 UNI 117/240 VAC, 英国插头 (HPN4011_)
- 电源 14 伏 15 安培 UNI 117/240 VAC, 美国插头 (HPN4007_)
- 用于后部附件连接插座的硬件套件 (PMLN5072_)
- 有扬声器的桌上型底盘 (RSN4005_)

安装套件

- 屏幕保护膜, 透明 (单包包含一件) (AY000269A01_) ¹⁵
- In Dash (DIN) 安装套件 (RLN6465_)
- 薄断面耳轴套件 (RLN6466_)
- 厚断面耳轴套件 (RLN6467_)

- 键锁耳轴套件 (RLN6468_)
- 薄型耳轴 - 袋 (RLN6469_)
- 远程安装收发器接口 (PMLN6402_)
- 远程安装控制头接口 (PMLN6403_)

其他附件

- 电涌保护器、塔架安装套件 (DQT1)
- 电涌保护器、同轴保护器隔板 (DSISB50LNC2MA)
- PL259/Mini-U 天线适配器, 8 英尺 (2.4 米) 电缆 (HKN9557_)
- 麦克风悬挂夹 (所有麦克风) (HLN9073_)
- 通用麦克风悬挂夹 (所有麦克风) (HLN9414_)
- IMPRES 移动 MAP 非 PC 适配器 (PMKN4072_)
- IMPRES 移动 MAP 非 PC 适配器 (PMKN4070_)
- 通用选件板 (PMLN5718_S)
- 关键作业无线单线监听套件, 带透明管 (PMLN7052_) ¹⁶
- 按通话按键 (RLN5926_)

¹⁵ 您的对讲机与此处所列附件兼容。有关详细信息, 请咨询您的经销商。

¹⁶ 您的对讲机与此处所列附件兼容。有关详细信息, 请咨询您的经销商。

- 紧急呼叫脚踏开关 (RLN5929_)

扬声器

- 13 瓦外部扬声器 (RSN4002_)
- 7.5 瓦外部扬声器 (RSN4003_)
- 5 瓦外部扬声器 (RSN4004_)

目次

重要な安全情報.....	26	WAVE 個別通話の受信と応答.....	41
ソフトウェア バージョン.....	27	WAVE モードから無線機モードへの切り替え.....	41
著作権.....	28	WAVE Tactical/5000.....	42
コンピュータ ソフトウェア 著作権.....	30	アクティブ WAVE チャンネルの設定.....	42
使用上のご注意.....	31	WAVE チャンネル情報の表示.....	42
章 1: 基本操作.....	32	WAVE エンドポイントの表示.....	42
無線機の電源投入.....	32	WAVE 構成の変更.....	43
無線機の電源オフ.....	32	WAVE グループ通話の発信.....	44
音量の調節.....	32	部 I: Capacity Max の操作.....	45
章 2: 無線機コントロール.....	34	プッシュトゥトーク (PTT) ボタン.....	45
音量/チャンネル ノブ.....	34	プログラム可能ボタン.....	45
デュアル ノブ操作優先度の設定.....	35	指定可能な無線機機能.....	46
キーパッド マイク ボタン.....	36	指定可能な設定またはユーティリティ機能.....	48
章 3: WAVE.....	39	プログラムされた機能へのアクセス.....	48
WAVE OnCloud/OnPremise.....	39	ステータス インジケータ.....	49
無線機モードから WAVE モードへの切り替え.....	39	アイコン.....	49
WAVE グループ通話の発信.....	40	LED インジケータ.....	55
WAVE グループ通話の受信と応答.....	40	トーン.....	56
		オーディオ トーン.....	56
		インジケータ トーン.....	57
		登録.....	57

ゾーンとチャンネルの選択.....	58	連絡先リストを使用したブロードキャスト コール	の発信.....	70
ゾーンの選択.....	58	プログラム可能な数値キーを使用したブロードキャスト コール	の発信.....	71
エイリアス検索を使用したゾーンの選		ブロードキャスト コールの受信..		72
択	59	個別コール.....		72
通話タイプの選択.....	59	個別通話の発信.....		73
サイトの選択.....	60	プログラム可能な数値キーを使	用した個別コールの発信	73
ローミング要求.....	60	エイリアス検索を使用した個別	コールの発信	74
サイト ロック オン/オフ.....	60	ワンタッチ コール ボタンを使	用した個別コールの発信.....	76
サイト制限.....	61	ダイアルを使用した個別コール	の発信	77
サイト トランキング.....	61	個別コールの受信.....		78
通話.....	62	個別コールの受信.....		78
グループ通話.....	63	個別コールの拒否.....		79
グループ通話の発信.....	63	一斉コール.....		79
連絡先リストを使用したグルー		一斉コールの発信.....		80
プ コールの発信.....	64	プログラム可能な数値キーを使	用した一斉コールの発信	80
プログラム可能な数値キーを使				
用したグループ コールの発信	65			
エイリアス検索を使用したグル				
ープ コールの発信	66			
グループ コールへの応答.....	68			
ブロードキャスト コール.....	69			
ブロードキャスト コールの発信..	70			

エイリアス検索を使用した一斉 コールの発信.....	81	音声割り込みの有効化.....	97
一斉コールの受信.....	83	高度な機能.....	98
電話通話.....	83	通話キュー.....	98
電話通話の発信.....	84	優先通話.....	98
プログラム可能なボタンで電話 通話を行う 	85	グループ スキャン.....	99
連絡先リストを使用した電話通 話の発信.....	87	グループ スキャンのオンとオフ の切り替え.....	99
エイリアス検索を使用した電話 通話の発信.....	89	受信グループ リスト.....	100
ダイヤルを使用した電話通話の 発信.....	92	優先度モニタ.....	101
デュアル トーン マルチ周波数....	94	グループの優先度の設定.....	101
DTMF 通話の開始.....	94	複数グループの加入.....	102
一斉コールとして電話通話への 応答.....	95	加入グループの追加.....	102
グループ コールとして電話通話 への応答.....	95	加入グループの削除.....	103
個別コールとして電話通話への 応答.....	96	トークバック.....	104
割り込み通話.....	96	Bluetooth	105
音声割り込み.....	97	ブルートウースのオン/オフの切 り替え.....	105
		Bluetooth デバイスへの接続.....	106
		検出可能モードでの Bluetooth デバイスへの接続.....	107
		Bluetooth デバイスからの切断..	108

内部無線機スピーカと Bluetooth デバイスの間のオー ディオルートの切り替え.....	109	ダイアルを使用したりリモート モ ニタの開始.....	117
デバイスの詳細の表示.....	109	連絡先設定.....	118
デバイス名の削除.....	109	プログラム可能な数値キーへの エントリの割り当て.....	119
Bluetooth マイクゲイン.....	110	エントリとプログラミング可能 な数値キー間の関連付けの削除.....	120
屋内位置.....	110	新規連絡先の追加.....	121
屋内位置のオンとオフ.....	111	通話インジケータ設定.....	122
屋内位置ビーコン情報へのアク セス	112	着信音のオンとオフの切り替え (個別コール用).....	122
マルチサイト コントロール.....	113	着信音のオンとオフの切り替え (テキスト メッセージ用).....	122
手動サイト 検索の開始.....	113	着信音のオンとオフの切り替え (ページング用).....	123
サイト ロック オン/オフ.....	113	着信音のオンとオフの切り替え (選択コール用).....	124
隣接サイトのリストへのアクセ ス	114	着信音のオンとオフの切り替え (テキスト付きテレメータ ステ ータス用).....	125
ホーム チャネル リマインダ.....	114	着信音スタイルの割り当て.....	125
ホーム チャネル リマインダの ミュート	114	警告トーンの音量を上げる	126
新しいホーム チャネルの設定... ..	114	通話履歴機能.....	126
[リモート モニタ].....	115		
リモート モニタの開始.....	116		
連絡先リストを使用したりモー ト モニタの開始	116		

最近の通話の表示.....	126	緊急アラームの受信.....	139
通話リストからのエイリアスマ たは ID の保存.....	127	緊急アラームへの応答	140
通話リストからの通話の削除....	128	通話による緊急アラームへの応 答	141
通話リストからのすべての通話 の削除.....	128	ステータス メッセージ.....	142
通話リストからの詳細の表示....	129	ステータス メッセージの送信... 142	
ページング操作.....	130	プログラム可能ボタンを使用し たステータス メッセージの送信 143	
ページングの発信.....	130	連絡先リストを使用したステー タス メッセージの送信.....	144
連絡先リストを使用したページ ングの発信.....	131	ダイアルを使用したステータス メッセージの送信.....	145
ページングへの応答.....	131	ステータス メッセージの表示... 146	
ミュート モード.....	132	ステータス メッセージへの応答 146	
ミュート モードの有効化.....	132	ステータス メッセージの削除... 147	
ミュート モード タイマーの設 定	133	すべてのステータス メッセージ の削除.....	148
ミュート モードの終了.....	133	テキスト メッセージング.....	148
緊急操作.....	134	テキスト メッセージ.....	149
緊急アラームの送信.....	135	テキスト メッセージの表 示	149
通話による緊急アラームの送信. 136		テレメータ ステータス メッセージの表示.....	149
緊急アラームと音声ガイドの送 信	137		

テキスト メッセージへの 応答.....	150	送信済みテキスト メッセ ージの表示.....	159
クイック テキストによる テキスト メッセージへの 返信.....	151	送信済みテキスト メッセ ージの送信.....	160
テキスト メッセージの再 送信.....	152	送信 BOX フォルダから の送信済みテキスト メッ セージの削除.....	160
テキスト メッセージの転 送	152	送信 BOX フォルダから のすべての送信済みテキ スト メッセージの削除...	161
ダイアルを使用したテキ スト メッセージの転送...	153	保存されたテキスト メッセ ージの表示.....	161
テキスト メッセージの編 集	154	保存されたテキスト メッ セージの編集.....	162
テキスト メッセージの入 力	155	下書きフォルダに保存し たテキスト メッセージの 削除.....	163
テキスト メッセージの送 信	156	クイック テキスト メッセ ージの送信	164
受信 BOX からのテキス ト メッセージの削除.....	157	テキスト入力設定.....	165
受信 BOX からのすべて のテキスト メッセージの 削除.....	158	文字修正の有効化/無効化.....	165
送信済みテキスト メッセ ージ...	158	単語予測の有効化/無効化.....	166

文章大文字修正.....	167	秘話モードのオンとオフの切り 替え	179
カスタム語の表示.....	167	応答禁止.....	180
カスタム語の編集.....	168	応答禁止の有効化または無効化..	180
カスタム語の追加.....	169	機能停止/復帰.....	181
カスタム語の削除.....	170	無線機の機能停止.....	181
すべてのカスタム語の削除.....	171	連絡先リストを使用した無線機 の機能停止.....	182
JOB チケット	172	ダイヤルを使用した無線機の機 能停止.....	182
JOB チケット フォルダへのア クセス.....	173	無線機の復帰.....	183
リモート サーバーのログインと ログアウト.....	173	連絡先リストを使用した無線機 の復帰.....	184
JOB チケットの作成.....	174	ダイヤルを使用した無線機の復 帰	185
JOB チケットへの応答.....	174	無線終了.....	186
単数の JOB チケット テンプレ ートを使った JOB チケットの 送信	175	ローン ワーカー.....	186
複数の JOB チケット テンプレ ートを使った JOB チケットの 送信	176	パスワード ロック機能.....	186
JOB チケットの削除.....	177	パスワードを使用した無線機へ のアクセス.....	186
すべての JOB チケットの削除..	178	ロック状態の無線機をロック解 除する	187
プライバシ.....	178		

パスワード ロックのオンとオフ の切り替え.....	188	ネットワーク アクセス ポイン トへの接続.....	196
パスワードの変更.....	189	Wi-Fi 接続ステータスの確認.....	197
通知リスト.....	190	ネットワーク リストの更新.....	198
通知リストへのアクセス.....	190	ネットワークの追加.....	198
エア接続プログラミング.....	190	ネットワーク アクセス ポイン トの詳細の表示.....	199
サードパーティ周辺機器接続モードの 選択.....	191	ネットワーク アクセス ポイン トの削除.....	200
受信信号強度インジケータ.....	192	動的グループ番号割当 (DGNA).....	201
RSSI 値の表示.....	192	DGNA コールの発信.....	202
正面パネル設定.....	192	DGNA 以外の通話の発信.....	202
正面パネル設定モードの開始....	192	DGNA 通話の受信と応答.....	202
FPP モード パラメータの編集..	192	ユーティリティ.....	203
Wi-Fi 操作.....	193	出力レベル.....	203
Wi-Fi のオン/オフの切り替え....	194	出力レベルの設定.....	203
指定された無線機を使用してリ モートで Wi-Fi をオンまたはオ フにする (個別制御).....	194	無線機トーン/アラートのオンとオフの 切り替え.....	204
指定された無線機を使用してリ モートで Wi-Fi をオンまたはオ フにする (グループ コントロー ル).....	195	キー操作音のオンとオフの切り替え....	205
		トーン/アラートのボリューム オフセ ット レベルの設定.....	205
		通話許可トーンのオンとオフの切り替 え.....	206

パワー アップ トーンのオンとオフの切り替え.....	207	デジタル マイク AGC のオンとオフの切り替え.....	216
メッセージ アラーム トーンの設定.....	207	インテリジェント オーディオのオンとオフの切り替え.....	217
表示モードの変更.....	208	ハウリング抑制機能のオンとオフの切り替え.....	218
表示輝度の調整.....	209	トリル拡張のオンとオフの切り替え....	219
ホーンとライトのオンとオフの切り替え	210	音声アンビエンス.....	219
LED インジケータのオンとオフの切り替え.....	210	音声アンビエンスの設定.....	220
パブリック アドレス システムのオンとオフの切り替え.....	211	音声プロファイル.....	220
外部パブリック アドレス システムのオンとオフの切り替え.....	212	音声プロファイルの設定.....	221
初期画面のオンとオフの切り替え.....	212	グローバル ナビゲーション サテライトシステム (GNSS) のオンとオフの切り替え.....	221
言語の設定.....	213	一般無線機情報.....	222
ケーブル タイプの特定.....	214	無線エイリアスと ID のチェック	223
音声ガイドのオンとオフの切り替え....	214	ファームウェアとコードプラグのバージョンチェック.....	223
オプション ボードのオンとオフの切り替え.....	214	ソフトウェア更新情報のチェック	224
音声変換.....	215	GNSS 情報の確認.....	224
音声変換の設定.....	215	サイト情報の表示.....	225
カメラ メニュー タイマー.....	216		

エンタープライズ Wi-Fi 証明書の詳細 の表示.....	226	Connect Plus モードでの通話の着信と発信...	237
部 II: Connect Plus の操作.....	227	サイトの選択.....	237
Connect Plus モードでの追加の無線機コント ロール.....	227	ローミング要求.....	237
プッシュアウトーク (PTT) ボタン.....	227	サイト ロック オン/オフ.....	238
プログラム可能ボタン.....	227	サイト制限.....	238
指定可能な無線機機能.....	228	ゾーン選択.....	238
指定可能な設定またはユーティ リティ機能.....	229	複数ネットワークの使用.....	239
Connect Plus モードでのステータス インジケータの特定.....	230	通話タイプの選択.....	240
ディスプレイ アイコン.....	230	無線通話の受信と応答.....	240
通話アイコン.....	233	グループ コールの受信と応答..	240
高度なメニュー アイコン.....	233	個別コールの受信と応答.....	241
送信 BOX アイコン.....	234	サイト一斉コールの受信.....	242
Bluetooth デバイス アイコン.....	235	着信個別無線通話の受信.....	242
LED インジケータ.....	235	個別電話着信でバッファ されたオーバーダイアル を作成.....	243
インジケータ トーン.....	236	個別電話着信でライブ オーバーダイアルを作成....	243
アラート トーン.....	236	着信電話グループ通話の受信....	244
Connect Plus モードと Non-Connect Plus モードの切り替え.....	236	着信マルチグループ通話.....	244
		無線通話の発信.....	244

















チャンネル セレクタ ノブを使った通話の発信.....	245	接続された個別電話発信でライブ オーバーダイアルを作成.....	253
グループ コールの発信...	245	Connect Plus モードでの高度な機能.....	253
個別コールの発信.....	245	ホーム チャンネル リマインダ.....	253
サイト一斉コールの発信.	246	自動フォールバック.....	254
マルチグループ コールの発信.....	247	自動フォールバック モードの通知	254
ワンタッチ コール ボタンを使用した個別コールの発信.....	247	フォールバック モードでの通話の発信/受信.....	255
プログラム可能なダイアル ボタンで通話を行う.....	248	通常動作への復帰.....	255
個別コールの発信.....	248	無線機チェック.....	256
プログラム可能なダイアル ボタンからの個別電話発信.....	249	無線機チェックの送信.....	256
[Tel] メニューからの個別無線通信発信.....	249	[リモート モニタ].....	257
連絡先からの個別無線通話発信.	250	リモート モニタの開始.....	257
発信個別無線通話でのチャンネル許可の待機.....	252	スキャン.....	259
接続された個別電話発信でバッファされたオーバーダイアルを作成	252	スキャンの開始と停止.....	259
		スキャン中の送信への応答.....	260
		ユーザー設定可能スキャン.....	260
		スキャンのオンとオフの切り替え.....	261
		スキャン リストの編集.....	262
		[メンバーつか] メニューからのグループの追加または削除.....	263













スキャン動作の説明.....	265	連絡先リストからのページング の発信.....	275
トークバックのスキャン.....	265	ワンタッチ アクセス ボタンを 使用したページング.....	276
グループの優先度の設定.....	266	ミュート モード.....	277
連絡先設定.....	267	ミュート モードの有効化.....	277
連絡先からの個別コール発信....	268	ミュート モード タイマーの設 定.....	277
エイリアス検索による通話発信.	268	ミュート モードの終了.....	278
新規連絡先の追加.....	269	緊急操作.....	279
通話インジケータ設定.....	270	着信緊急の受信.....	280
ページング用着信音のオンとオ フの切り替え.....	270	緊急詳細のアラーム リストへの 保存.....	281
個別コール用着信音のオンとオ フの切り替え.....	271	緊急詳細の削除.....	281
テキスト メッセージ用着信音の オンとオフの切り替え.....	272	緊急コールへの応答.....	281
アラート タイプの選択.....	272	緊急アラートへの応答.....	282
警告トーンの音量を上げる.....	273	緊急復帰コールを無視.....	282
通話履歴.....	273	緊急コールの開始.....	283
最近の通話の表示.....	273	音声ガイド付き緊急コールの開 始.....	283
通話リストからの通話の削除....	274	緊急アラートの開始.....	284
通話リストからの詳細の表示....	274	緊急モードの終了.....	284
ページング操作.....	275		
ページングへの応答.....	275		









テキスト メッセージング.....	285	送信済みテキスト メッセージの送信.....	291
クイック テキスト メッセージの送信.....	285	送信済みアイテム内のすべての送信済みテキストメッセージの削除.....	293
ワンタッチ アクセス ボタンを使用したクイック テキスト メッセージの送信.....	286	テキスト メッセージの受信.....	294
下書きフォルダへのアクセス....	286	テキスト メッセージの表示.....	294
保存されたテキスト メッセージの表示.....	287	受信済みテキスト メッセージの管理.....	294
保存されたテキスト メッセージの編集と送信.....	287	[じゅしん BOX] のテキスト メッセージの表示.....	295
下書きフォルダからの保存されたテキスト メッセージの削除.....	288	[じゅしん BOX] のテキスト メッセージへの返信... ..	295
送信に失敗したテキスト メッセージの管理.....	289	[じゅしん BOX] のテキスト メッセージの削除.....	296
テキスト メッセージの再送信.....	289	受信 BOX からのすべてのテキスト メッセージの削除.....	297
テキスト メッセージの転送	290	秘話モード.....	298
送信済みテキスト メッセージの管理.....	290	プライバシー対応 (スクランブル) 通話の発信.....	299
送信済みテキスト メッセージの表示.....	290	セキュリティ.....	300
		無線停止.....	300







停止解除.....	302	指定された無線機を使用してリ モートで Wi-Fi をオンまたはオ フにする (個別制御).....	313
Bluetooth 動作.....	304	指定された無線機を使用してリ モートで Wi-Fi をオンまたはオ フにする (グループ コントロー ル).....	314
ブルートゥースのオン/オフの切 り替え.....	304	ネットワーク アクセス ポイン トへの接続.....	315
Bluetooth デバイスのサーチと 接続	305	Wi-Fi 接続ステータスの確認.....	316
Bluetooth デバイスからの検索 と接続 (検出可能モード).....	306	ネットワーク リストの更新.....	317
Bluetooth デバイスからの切断..	307	ネットワークの追加.....	317
内部無線機スピーカと		ネットワーク アクセス ポイン トの詳細の表示.....	318
Bluetooth デバイスの間のオー ディオ ルートの切り替え.....	307	ネットワーク アクセス ポイン トの削除.....	319
デバイスの詳細の表示.....	308	ユーティリティ.....	320
デバイス名の削除.....	308	無線機のトーンおよび警告のオ ンとオフの切り替え.....	320
Bluetooth マイクゲイン	309	トーン アラート ボリューム オ フセット レベルの設定.....	321
屋内位置.....	309	通話許可トーンのオンとオフの 切り替え.....	322
屋内位置のオンとオフ.....	310		
屋内位置ビーコン情報へのアク セス	311		
通知リスト.....	311		
通知リストへのアクセス.....	312		
Wi-Fi 操作.....	312		
Wi-Fi のオン/オフの切り替え.....	313		

パワー アップ警告トーンのオン とオフの切り替え.....	322	無線機モデル番号インデ ックスの確認.....	335
出力レベルの設定.....	323	オプション ボード OTA コードプラグ ファイルの CRC の確認.....	335
表示モードの変更.....	324	サイト ID (サイト番号) の 表示.....	336
表示輝度の調整.....	324	サイト情報の確認.....	336
導入画面のオンとオフの切り替 え	325	無線機 ID の確認.....	337
言語.....	326	ファームウェア バージョ ンとコードプラグ バージ ョンのチェック.....	338
LED インジケータのオンとオフ の切り替え.....	326	更新の確認.....	338
ケーブル タイプの特定.....	327	エンタープライズ Wi-Fi 証明書 の詳細の表示.....	347
音声ガイド.....	327	部 III: 他のシステム.....	348
メニュー タイマー.....	328	プッシュアウト ボタン.....	348
ホーンとライトのオンとオフの 切り替え.....	329	プログラム可能ボタン.....	348
デュアル ノブ操作優先度の設定	330	指定可能な無線機機能.....	348
デジタル Mic AGC (Mic AGC-D)	330	指定可能な設定またはユーティリティ 機能	351
インテリジェント オーディオ...	331	プログラムされた機能へのアクセス....	352
ハウリング抑制機能のオンとオ フの切り替え.....	333	ステータス インジケータ.....	353
GNSS のオンとオフの切り替え	333		
一般無線機情報へのアクセス....	334		

アイコン.....	353	プログラム可能な数値キーを使用したグループ コールの発信 	
LED インジケータ.....	359		369
トーン.....	360	グループ コールへの応答.....	369
インジケータ トーン.....	361	個別コール 	370
オーディオ トーン.....	361	個別通話の発信 	370
従来型アナログおよびデジタル モード.....	361	連絡先リストを使用した個別コールの発信 	371
アイコン情報.....	362	ダイヤルを使用した個別コールの発信 	372
IP サイト接続 	362	プログラム可能な数値キーを使用した個別コールの発信  	373
Capacity Plus–シングルサイト 	363	個別コールへの応答 	374
Capacity Plus–マルチサイト 	363	一斉コール.....	375
ゾーンとチャンネルの選択.....	364	一斉コールの受信.....	375
ゾーンの選択.....	364	一斉コールの発信.....	375
エイリアス検索を使用したゾーンの選択.....	365	プログラム可能な数値キーを使用した一斉コールの発信 	376
チャンネル選択.....	366	選択コール 	377
通話.....	366	選択コールの発信.....	377
グループ通話.....	367	選択コールへの応答 	377
グループ通話の発信.....	367	電話通話 	378
連絡先リストを使用したグループコールの発信.....	368		

電話通話の発信 	379	ブロードキャスト音声通話の発信	391
連絡先リストを使用した電話通話の発信 	380	プログラム可能な数値キーを使用したブロードキャスト音声通話の発信 	391
ダイヤルを使用した電話通話の発信 	382	エイリアス検索を使用したブロードキャスト音声通話の発信 	392
エイリアス検索を使用したグループコール、個別コール、無線機通話、または一斉コールの発信  	385	ブロードキャスト音声通話の受信	394
デュアルトーン マルチ周波数	387	未アドレス通話	394
DTMF 通話の開始	387	未アドレス通話の発信	395
グループコールとして電話通話への応答 	387	未アドレス通話への応答	395
一斉コールとして電話通話への応答 	388	オープン音声チャンネルモード (OVCM)	396
個別コールとして電話通話への応答 	388	OVCM コールへの発信	396
通話の停止 	389	OVCM コールへの応答	397
ダイレクトモード	390	高度な機能	397
リピータとダイレクトモードの切り替え	390	ホームチャンネルリマインダ	398
ブロードキャスト音声通話	391	ホームチャンネルリマインダのミュート	398
		新しいホームチャンネルの設定	398
		無線機チェック 	399
		無線機チェックの送信 	399







ダイアルを使用した無線機チェックの送信 	400	スキャン.....	410
リモート モニタ.....	401	スキャンのオンとオフの切り替え.....	410
リモート モニタの開始.....	401	スキャン中の送信への応答.....	411
連絡先リストを使用したリモート モニタの開始.....	402	迷惑チャンネルの削除.....	411
ダイアルを使用したリモート モニタの開始 	403	迷惑チャンネルの復元.....	412
スキャン リスト.....	405	投票スキャン 	412
スキャン リスト内のエントリの表示.....	405	連絡先設定.....	412
エイリアス検索を使用したスキャン リスト内のエントリの表示.....	406	連絡先リストを使用したグループ コールの発信.....	413
スキャン リストへの新規エントリの追加.....	406	連絡先リストを使用した個別コールの発信 	414
エイリアス検索を使用したスキャン リストへの新規エントリの追加 	407	プログラム可能な数値キーへのエントリの割り当て 	415
スキャン リストからのエントリの削除.....	408	エントリとプログラミング可能な数値キー間の関連付けの削除 	416
スキャン リストのエントリに対して優先度を設定する.....	409	新規連絡先の追加.....	417
		既定の連絡先の設定 	417
		通話インジケータ設定.....	418
		着信音のオンとオフの切り替え (ページング用).....	418

着信音のオンとオフの切り替え (個別コール用) 	419	ページングへの応答.....	428
着信音のオンとオフの切り替え (選択コール用) 	420	ミュート モード.....	428
着信音のオンとオフの切り替え (テキスト メッセージ用) 	421	ミュート モードの有効化.....	429
着信音のオンとオフの切り替え (テキスト付きテレメータ ステ ータス用).....	421	ミュート モード タイマーの設 定	429
着信音スタイルの割り当て.....	422	ミュート モードの終了.....	430
警告トーンの音量を上げる	423	緊急操作.....	430
通話履歴機能.....	423	緊急アラームの受信.....	431
最近の通話の表示.....	423	緊急アラームへの応答.....	432
通話リストからの通話の削除 	424	緊急アラーム受信後の緊急モー ドの終了.....	433
通話リストの詳細の表示 	425	緊急アラームの送信.....	433
通話リストからのエイリアスマ たは ID の保存 	425	通話による緊急アラームの送信.....	434
ページング操作.....	426	音声ガイドおよび緊急アラーム.....	436
ページングの発信.....	426	緊急アラームと音声ガイドの送 信 	436
連絡先リストを使用したページ ングの発信.....	427	緊急モードの再開.....	437
ダイアルを使用したページング の発信.....	427	緊急アラーム送信後の緊急モー ドの終了.....	437
		アラーム リストからのアラーム 項目の削除.....	438
		テキスト メッセージング.....	438

テキスト メッセージ	439
テキスト メッセージの表示	439
テレメータ ステータス メッセージの表示	439
テキスト メッセージへの 応答	440
クイック テキストによる テキスト メッセージへの 応答	441
テキスト メッセージの再 送信	442
テキスト メッセージの転 送	442
ダイアルを使用したテキ スト メッセージの転送	443
テキスト メッセージの編 集	444
テキスト メッセージの入 力	445
テキスト メッセージの送 信	446

受信 BOX からのテキス ト メッセージの削除	447
受信 BOX からのすべて のテキスト メッセージの 削除	448
送信済みテキスト メッセージ	448
送信済みテキスト メッセ ージの表示	449
送信済みテキスト メッセ ージの送信	450
送信 BOX フォルダから の送信済みテキスト メッ セージの削除	450
送信 BOX フォルダから のすべての送信済みテキ スト メッセージの削除	451
保存されたテキスト メッセージ	451
保存されたテキスト メッ セージの表示	452
保存されたテキスト メッ セージの編集	452

下書きフォルダに保存したテキスト メッセージの削除.....	453	JOB チケットへの応答.....	464
クイック テキスト メッセージ.....	453	単数の JOB チケット テンプレートを使った JOB チケットの送信	465
クイック テキスト メッセージの送信.....	454	複数の JOB チケット テンプレートを使った JOB チケットの送信	466
テキスト入力設定.....	455	JOB チケットの削除.....	467
文字修正の有効化/無効化.....	455	すべての JOB チケットの削除..	468
単語予測の有効化/無効化.....	456	プライバシ.....	468
文章大文字修正.....	457	秘話モードのオンとオフの切り替え.....	469
カスタム語の表示.....	457	応答禁止.....	470
カスタム語の編集.....	458	応答禁止の有効化または無効化.....	470
カスタム語の追加.....	459	マルチサイト コントロール.....	471
カスタム語の削除.....	460	手動サイト検索の開始.....	471
すべてのカスタム語の削除.....	461	サイト ロック オン/オフ.....	471
JOB チケット.....	462	隣接サイトのリストへのアクセス	472
JOB チケット フォルダへのアクセス.....	463	セキュリティ.....	472
リモート サーバーのログインとログアウト.....	463	無線機の無効化.....	472
JOB チケットの作成.....	464	連絡先リストを使用した無線機の無効化.....	473

ダイアルを使用した無線機の無効化 	474	屋内位置ビーコン情報へのアクセス	486
無線機の有効化 	475	通知リスト	487
連絡先リストを使用した無線機 の有効化 	476	通知リストへのアクセス	487
ダイアルを使用した無線機の有効化 	477	オートレンジトランスポンダシステム 	488
ローンワーカー	479	エア接続プログラミング 	488
Bluetooth	479	そうしんよくせい	489
ブルートゥースのオン/オフの切り替え	480	送信抑制の有効化	489
Bluetooth デバイスへの接続	480	送信抑制の無効化	489
検出可能モードでの Bluetooth デバイスへの接続	481	サードパーティ周辺機器接続モードの 選択	490
Bluetooth デバイスからの切断	482	受信信号強度インジケータ	490
内部無線機スピーカと Bluetooth デバイスの間のオーディオ ルートの切り替え	483	RSSI 値の表示	490
デバイスの詳細の表示	483	パスワードロック機能	491
デバイス名の削除	484	パスワードを使用した無線機への アクセス	491
Bluetooth マイクゲイン	484	ロック状態の無線機をロック解除する	492
屋内位置	485	パスワードロックのオンとオフ の切り替え	492
屋内位置のオンとオフ	485	パスワードの変更	493

正面パネル設定.....	494	スケルチ レベルの設定.....	503
正面パネル設定モードの開始....	494	出力レベル.....	504
FPP モード パラメータの編集..	494	出力レベルの設定.....	504
Wi-Fi 操作.....	495	無線機トーン/アラートのオンとオフの 切り替え.....	505
Wi-Fi のオン/オフの切り替え....	496	キー操作音のオンとオフの切り替え....	506
指定された無線機を使用してリ モートで Wi-Fi をオンまたはオ フにする (個別制御).....	496	トーン/アラートのボリューム オフセ ット レベルの設定.....	506
指定された無線機を使用してリ モートで Wi-Fi をオンまたはオ フにする (グループ コントロー ル).....	497	通話許可トーンのオンとオフの切り替 え	507
ネットワーク アクセス ポイン トへの接続.....	498	パワー アップ トーンのオンとオフの 切り替え.....	508
Wi-Fi 接続ステータスの確認.....	499	メッセージ アラーム トーンの設定.....	509
ネットワーク リストの更新.....	500	表示モードの変更.....	510
ネットワークの追加.....	500	表示輝度の調整.....	510
ネットワーク アクセス ポイン トの詳細の表示.....	501	ホーンとライトのオンとオフの切り替 え	511
ネットワーク アクセス ポイン トの削除.....	502	LED インジケータのオンとオフの切り 替え.....	512
ユーティリティ.....	503	パブリック アドレス システムのオン とオフの切り替え.....	512
スケルチ レベル.....	503	外部パブリック アドレス システムの オンとオフの切り替え.....	513

初期画面のオンとオフの切り替え.....	514
言語の設定.....	514
ケーブル タイプの特定.....	515
音声起動送信.....	515
音声起動送信のオンとオフの切り替え.....	516
音声ガイドのオンとオフの切り替え....	517
オプション ボードのオンとオフの切り替え.....	517
音声変換.....	517
音声変換の設定.....	518
自動通話転送のオンとオフの切り替え.....	518
カメラ メニュー タイマー.....	519
アナログ マイク AGC のオンとオフの切り替え.....	520
デジタル マイク AGC のオンとオフの切り替え.....	520
インテリジェント オーディオのオンとオフの切り替え.....	521
ハウリング抑制機能のオンとオフの切り替え.....	522
トリル拡張のオンとオフの切り替え....	523
音声アンビエンス.....	523

音声アンビエンスの設定.....	524
音声プロファイル.....	524
音声プロファイルの設定.....	525
グローバル ナビゲーション サテライトシステム (GNSS) のオンとオフの切り替え.....	525
フレックス RX リスト 	526
フレックス RX リストのオンとオフの切り替え.....	527
一般無線機情報.....	527
無線エイリアスと ID のチェック.....	528
ファームウェアとコードプラグのバージョンチェック.....	528
ソフトウェア更新情報のチェック.....	529
GNSS 情報の確認.....	529
サイト情報の表示.....	530
エンタープライズ Wi-Fi 証明書の詳細の表示.....	530
部 IV: 認可されたアクセサリ リスト.....	532

重要な安全情報

RF Energy Exposure and Product Safety Guide for Mobile Two-Way Radios

注意!

この無線機は業務用の利用に限定されています。本無線機をご使用になる前に、『車載型業務用無線機の電磁波エネルギー被曝および製品安全性ガイド』をよくお読みください。安全にお使いいただくための取り扱い方法と、電磁波エネルギーについての重要な説明が記載されています。また、電磁波エネルギー被曝限度についての該当基準および法規制に対する適合情報も記載されています。

Motorola Solutions 承認アンテナおよびその他のアクセサリのリストは、次の Web サイトでご確認ください。

<http://www.motorolasolutions.com>

タイで利用可能なモデル:

อุปกรณ์โทรคมนาคมนี้ได้ปฏิบัติตามข้อกำหนดของคณะกรรมการกิจการ

โทรคมนาคมแห่งชาติ

この通信機器は、National Telecommunications Commission の要件に適合しています。

ソフトウェアバージョン

以下のセクションで説明されているすべての機能は、ソフトウェアバージョン **R02.10.00.0000** 以降でサポートされます。

無線機のソフトウェアバージョンを確認するには、「[ファームウェアとコードプラグのバージョンチェックページ](#) **223**」を参照してください。

詳細については、ディーラーまたはシステム管理者にご確認ください。

著作権

本書に記載されている **Motorola Solutions** 製品には、著作権取得済み **Motorola Solutions** コンピュータプログラムが含まれている場合があります。米国およびその他諸国の法律で、著作権取得済みのコンピュータプログラムの一定の独占権が **Motorola Solutions** のために保護されています。従って、本書で説明される **Motorola Solutions** 製品に含まれるいかなる著作権取得済み **Motorola Solutions** コンピュータプログラムも、**Motorola Solutions** からの書面による明示的な許可なしに、いかなる方法においても複製または再生してはなりません。

© 2019 Motorola Solutions, Inc. All Rights Reserved

本書のいかなる部分についても、いかなる形式であろうと、いかなる手段によっても、**Motorola Solutions, Inc.** からの事前の書面による許可なしに複製、伝送、情報検索システムへの格納、あらゆる言語への翻訳、コンピュータ言語への変換をしてはいけません。

さらに、**Motorola Solutions** 製品の購入は、直接的あるいは黙示的、禁反言的、またはその他の方法によって、**Motorola Solutions** の著作権、特許または特許アプリケーションの対象となる一切のライセンスを付与するものとみなされないものとします。ただし、製品の販売において法の運用によって生ずる通常の非独占的、ロイヤルティ不要の使用ライセンスについては、この限りではありません。

免責条項

一部のシステムに対して、このマニュアルで説明する機能、設備、性能が適用されない、またはライセンスされない場合があります。また、無線機ユニットの特性や特定のパラメータの設定に依存する場合があります。詳しくは、**Motorola Solutions** の担当者にご確認ください。

商標

MOTOROLA、**MOTO**、**MOTOROLA SOLUTIONS**、および **Stylized M** ロゴは、**Motorola Trademark Holdings, LLC** の商標または登録商標であり、許可の下に使用されます。その他すべての商標は、個々の商標権者に帰属します。

欧州連合 (EU) 電気および電子機器リサイクル法 (WEEE) 指令



■ 欧州連合の WEEE 指令では、EU 諸国に販売される製品 (場合によってはパッケージ) にゴミ箱への投入禁止ラベルを貼ることを要求しています。

WEEE 指令で規定されるとおり、このゴミ箱への投入禁止ラベルは、EU 諸国の顧客とエンドユーザーが、電気と電子装置またはアクセサリを生活廃棄物として廃棄してはならないことを意味します。

EU 諸国の顧客またはエンドユーザーは、自国の廃棄物収集システムについて、地元の販売代理店またはサービスセンターに問い合わせる必要があります。

コンピュータソフトウェア著作権

本マニュアルに記載されている **Motorola Solutions** 製品には、半導体メモリやその他メディアに保管されている著作権取得済み **Motorola Solutions** コンピュータプログラムが含まれている場合があります。米国およびその他諸国の法律で、著作権取得済みのコンピュータプログラムの一定の独占権が **Motorola Solutions** のために保護されています。この際、著作権取得済みコンピュータプログラムのあらゆる形態での複製または再生の独占権が含まれますが、これに限定されません。したがって、本マニュアルで説明される **Motorola Solutions** 製品に含まれるいかなる著作権取得済み **Motorola Solutions** コンピュータプログラムも、**Motorola Solutions** からの書面による明示的な許可を得なければ、いかなる方法においても複製、再生、修正、リバースエンジニアリング、配信できません。さらに、**Motorola Solutions** 製品を購入しても、直接的あるいは黙示的、禁反言的、またはその他の方法によっても、**Motorola Solutions** の著作権、特許、または特許出願の対象となるライセンスは、一切付与されません。ただし、製品の販売において法の運用によって生じる通常の非独占的な使用ライセンスについては、この限りではありません。

本製品に組み込まれている **AMBE+2™** 音声コーディング技術は、**Digital Voice Systems, Inc.** の特許、著作権、企業秘密を含む知的所有権で保護されています。

この音声コーディング技術は、この通信機器の範囲内での使用のみを対象にライセンス付与されています。この技術を使用するユーザーは、オブジェクトコードを逆コンパイル、リバースエンジニアリング、逆アセンブルしようと試みること、またはいかなる方法においてもオブジェクトコードを人間が読み取り可能な形式に変換しようと試みることを明確に禁じています。

米国特許番号 **#5,870,405**、**#5,826,222**、**#5,754,974**、**#5,701,390**、**#5,715,365**、**#5,649,050**、**#5,630,011**、**#5,581,656**、**#5,517,511**、**#5,491,772**、**#5,247,579**、**#5,226,084** および **#5,195,166**。

使用上のご注意

MOTOTRBO シリーズのデジタル携帯型無線機は IP67 仕様を満たしているため、水に浸るような悪条件の野外でも使用できます。このセクションでは、いくつかの基本的な使用上のご注意について説明します。



注意:

無線機を分解しないでください。分解すると無線機のシールが損傷し、無線機にリークパスが生じることがあります。無線機のメンテナンスは、無線機のシールのテスト、交換が可能なサービスステーションで実施してください。

- 無線機が水没した場合は、無線機を振ってスピーカグリルやマイクポート内に入り込んでいる可能性のある水を除去してください。水が入り込むと、音声が悪化することがあります。
- 無線機のバッテリーの接触面が水に濡れた場合は、バッテリーを無線機に接続する前に、無線機およびバッテリーのバッテリー接触面をクリーニングして乾かしてください。水が残ると、無線機がショートすることがあります。
- 無線機が腐食性物質 (たとえば、塩水) に浸かった場合は、無線機およびバッテリーをきれいな水ですすいでから無線機およびバッテリーを乾かしてください。

- 無線機の外面をクリーニングするには、低刺激性の食器用洗剤の希釈液と真水 (たとえば、3 リットルの水に大さじ 1 杯の洗剤) を使用してください。
- バッテリー接触面の下の無線機シャーシにあるベント (穴) を突かないでください。このベントには、無線機内部の圧力を均等化する働きがあります。ベントを突くと無線機へのリークパスが生じ、無線機の防水性が損なわれることがあります。
- ベントを塞いだり、覆ったりしないでください。ラベルも貼らないでください。
- 油性物質がベントに接触しないようにしてください。
- アンテナが正しく取り付けられた無線機は最深 1 メートル (3.28 フィート)、最長 30 分の防水性能を備えています。最大限度値を超えたり、アンテナなしで使用したりすると、無線機が損傷するおそれがあります。
- 無線機をクリーニングする際には、高圧ジェットスプレーを使用しないでください。水深 1 メートルの水圧を超えるので、無線機に水が浸入する場合があります。

基本操作

この章では、無線機を使い始めるための操作について説明します。

無線機の電源投入

下記の手順に従って、無線機の電源を入れます。

オン/オフ ボタンを押します。

正常に行われた場合:

- トーンが鳴ります。
- 緑色の LED が点灯します。
- ディスプレイに【MOTOTRBO (TM)】が表示された後、歓迎のメッセージまたは画像が表示されます。
- ホーム画面が点灯します。

トーン/アラート機能が無効になっている場合は、起動時にトーンは鳴りません。

無線機の電源が入らない場合、バッテリーを確認してください。バッテリーが充電され、正しく取り付けられているかどうか確認してください。それでも無線機の電源が入らない場合、ディーラーにお問い合わせください。

無線機の電源オフ

下記の手順に従って、無線機の電源をオフにします。

【オン/オフ】 ボタンを押し続けます。

無線機の電源が完全にオフになるまでに、最長で7秒かかる場合があります。

ディスプレイに【でんげんシャットダウン】と表示されます。

音量の調節

下記の手順に従って、無線機の音量レベルを変更します。

以下のいずれか1つの手順を実行します。

- 音量を上げるには、**オン/オフ/音量コントロールノブ**を時計回りに回します。
- 音量を下げるには、**オン/オフ/音量コントロールノブ**を反時計回りに回します。

**注記:**

無線機には、最小音量のオフセットをプログラムできます。プログラムされた最小音量より下げることにはできなくなります。詳細については、ディーラーまたはシステム管理者にご確認ください。

無線機コントロール

この章では、無線機を制御するボタンと機能について説明します。

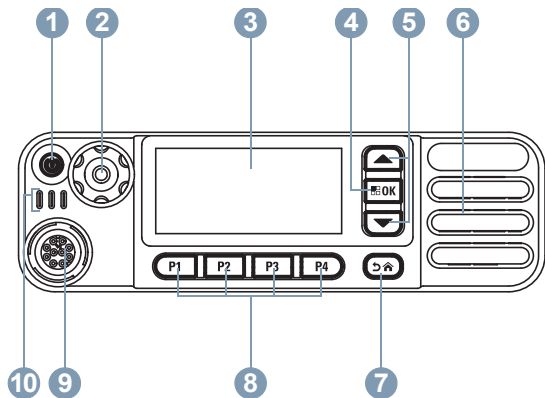

- 1 オン/オフ/情報ボタン
- 2 音量/チャンネル ノブ
- 3 ディスプレイ
- 4 メニュー/OK ボタン
- 5 スクロール アップ/ダウン ボタン
- 6 スピーカ



- 7 戻る/ホーム ボタン
- 8 正面プログラム可能ボタン
- 9 アクセサリ コネクタ
- 10 LED インジケータ

音量/チャンネル ノブ

音量/チャンネル ノブは、音量とチャンネルのデュアルコントロール用、または音量コントロール専用プログラムできます。

音量を調節するには、「[音量の調節 ページ 32](#)」を参照してください。



チャンネルを変更するには、チャンネル選択状態が表示されるまで音量/チャンネル ノブを押し続けます。音量/チャンネル ノブを回して、チャンネルを選択します。下記のいずれかの手順に従って、チャンネル選択状態を終了します。



- 音量/チャンネル ノブを押します。
-  を押します。
-  を押します。
- メニュー タイマーが切れるのを待ちます。



デュアルノブ操作優先度の設定

下記の手順に従って、無線機のデュアルノブ操作優先度の設定を行います。



1  を押してメニューにアクセスします。

2  または  を押して【せってい】に移動します。 を押して選択します。

3  または  を押して【きのうせってい】に移動します。 を押して選択します。

4  または  を押して【デュアルダイヤル】に移動します。 を押して選択します。

ディスプレイに【おんりょうのみ】と【おんりょうCH】が表示されます。







5  または  を押して必要な設定に移動します。 を押して選択します。

選択した設定の隣に✓が表示されます。画面は前のメニューに戻ります。

キーパッド マイク ボタン

4 ウェイ ナビゲーション キーパッド マイク (Motorola Solutions 部品番号 RMN5127_) の 3 x 4 英数字キーパッドを使用して、無線機の機能にアクセスできます。1つのキーを複数回押さないと入力できない文字もあります。次の表は、必要な文字を入力するために1つのキーを押す回数を示します。

キー	キーを押す回数												
	1	2	3	4	5	6	7	8	9	10	11	12	13
① .,?	1	.]	,	?	!	@	&	'	%	—	:	*	#
② ABC	A	B	C	2									
③ DEF	D	E	F	3									
④ GHI	G	H	I	4									
⑤ JKL	J	K	L	5									

キー	キーを押す回数												
	1	2	3	4	5	6	7	8	9	10	11	12	13
	M	N	O	6									
	P	Q	R	S	7								
	T	U	V	8									
	W	X	Y	Z	9								
	0												
	* または del												
	# または												

**注記:**

押すと「0」が入力されます。長く押すと **CAPS lock** がオンになります。再度長く押すと、**CAPS lock** がオフになります。

**注記:**

テキストの入力中に押すと、文字が削除されます。数字の入力中に押すと、“*”が入力されます。

**注記:**

テキストの入力中に押すと、スペースが挿入されます。数字の入力中に押すと、“#”が入力されます。

キー	キーを押す回数												
	1	2	3	4	5	6	7	8	9	10	11	12	13
スペ													
ース													

WAVE

Wide Area Voice Environment (WAVE™) では、新しい方法で、2 台以上の無線機間で通話を行います。

WAVE を使用すると、Wi-Fi を使用して、異なるネットワークやデバイスで通信できます。無線機が Wi-Fi 経由で IP ネットワークに接続すると、WAVE 通話が実行されます。

無線機は次の異なるシステム構成をサポートします。

- WAVE OnCloud/OnPremise
- WAVE Tactical/5000

WAVE 通話を開始する方法は、各システムタイプにより異なります。無線機のシステム構成に応じて適切なセクションを参照してください。

表 1: WAVE の表示アイコン



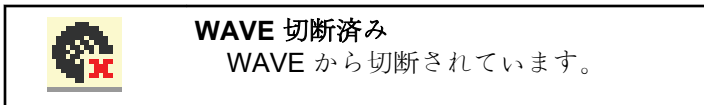
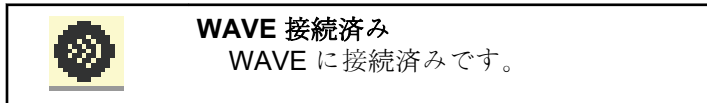

WAVE が有効な場合、ディスプレイには以下のアイコンが一時的に表示されます。



注記:
この機能は、特定のモデルのみに適用されます。

WAVE OnCloud/OnPremise

無線機モードから WAVE モードへの切り替え

- 以下のいずれか 1 つの手順を実行します。
 - プログラムされた **[WAVE]** ボタンを押します。以下の手順をスキップします。
 -  を押してメニューにアクセスします。
-  または  を押して **[WAVE]** に移動します。  を押して選択します。

黄色の LED が 2 回点滅します。

ディスプレイに【WAVE にきりかえ】を示す瞬間的な通知が表示され、【WAVE の準備中】が表示されます。



注記:

WAVE モードに切り替えると、無線機は自動的に Wi-Fi を有効にします。

正常に行われた場合:

- 点滅する黄色の LED が消灯します。
- ディスプレイに、WAVE 接続済みアイコン、【<グループ エイリアス>】、および【<チャンネル インデックス>】と表示されます。

正常に行われなかった場合:

- ネガティブトーンが鳴ります。
- 赤色の LED が点滅します。
- ディスプレイに、WAVE 接続済みアイコンおよび【せつぞくなし】または【有効化: 失敗】が、エラータイプに応じて表示されます。



注記:

新しい設定が無線機に更新されると、同期が行われます。WAVE モードに入ると、無線機に【同期中...】と表示されます。同期が完了すると、無線機はホーム画面に戻ります。

WAVE グループ通話の発信

- 1 チャンネルセレクトノブ/ボタンを使用して、WAVE グループを選択します。

- 2 PTT ボタンを押して通話を発信します。

正常に行われた場合: ディスプレイに、グループ通話アイコンと WAVE グループエイリアスが表示されます。

正常に行われなかった場合:

- ネガティブインジケータトーンが鳴ります。
- ディスプレイに【コールしっぱい】または【さんかしゃなし】の通知が瞬間的に表示されます。

WAVE グループ通話の受信と応答

WAVE グループ通話を受信した場合:

- トーンが鳴ります。
- ディスプレイに、グループ通話アイコン、WAVE グループエイリアス、および発信者のエイリアスが表示されません。

- 無線機のミュートが解除され、着信通話の音はスピーカから聞こえます。

1 電話に応答するには、**[PTT]** ボタンを押します。

2 相手の声を聞くには、**PTT** ボタンを放します。

WAVE 個別通話の受信と応答

WAVE 個別通話を受信する場合:

- トーンが鳴ります。
- ディスプレイに [個別通話] アイコンと発信者のエイリアスが表示されます。
- 無線機のミュートが解除され、着信通話の音はスピーカから聞こえます。



1 電話に応答するには、**[PTT]** ボタンを押します。

2 相手の声を聞くには、**PTT** ボタンを放します。

WAVE モードから無線機モードへの切り替え

1 以下のいずれか 1 つの手順を実行します。

- プログラムされた **[無線機モード]** ボタンを押します。以下の手順をスキップします。
-  を押してメニューにアクセスします。

2  または  を押して [むせんきモード] に移動します。  を押して選択します。

黄色の LED が 2 回点滅します。

ディスプレイに [むせんにきりかえ] を示す瞬間的な通知が表示され、[無線機の準備中] が表示されます。

成功した場合:

- 点滅する黄色の LED が消灯します。
- ステータスバーから WAVE 接続済みアイコンが消えます。ディスプレイに [グループ エイリアス] および [チャンネル インデックス] と表示されます。

WAVE Tactical/5000

アクティブ WAVE チャンネルの設定







注記:

WAVE チャンネルは、CPS を使用して構成されます。WAVE チャンネルに入ると、無線機は自動的に Wi-Fi を有効にし、WAVE サーバーにログインします。

- 1  を押してメニューにアクセスします。

- 2  または  を押して、[WAVE チャンネル] に移動します。  を押して選択します。



- 3  または  を押して、必要な WAVE チャンネルに移動します。  を押して選択します。



- 4  または  を押して、[アクティブに設定] に移動します。  を押して選択します。



ディスプレイで、選択したチャンネルの横に  が表示されます。

WAVE チャンネル情報の表示

- 1 以下のいずれか 1 つの手順を実行します。
 - プログラムされた [WAVE チャンネル リスト] ボタンを押します。以下の手順をスキップします。
 -  を押してメニューにアクセスします。

- 2  または  を押して、[WAVE チャンネル] に移動します。  を押して選択します。

- 3  または  を押して、必要な WAVE チャンネルに移動します。  を押して選択します。



- 4  または  を押して [しようさい] に移動します。  を押して選択します。



ディスプレイに WAVE チャンネルの詳細が表示されます。

WAVE エンドポイントの表示

- 1 以下のいずれか 1 つの手順を実行します。

- プログラムされた **【連絡先】** ボタンを押します。
ステップ 3 にスキップします。
-  を押してメニューにアクセスします。

2  または  を押して **【エンドポイント】** に移動します。  を押して選択します。

3  または  を押して必要な **WAVE** エンドポイントに移動します。  を押して選択します。



4  を押して **【しようさい】** を選択します。



ディスプレイに **WAVE** エンドポイントの詳細が表示されます。



WAVE 構成の変更



以下の手順に従い、**WAVE** のサーバー IP アドレス、ユーザー ID、パスワードを設定します。



1  を押してメニューにアクセスします。



2  または  を押して **【せってい】** に移動します。  を押して選択します。



3  または  を押して **【きのうせってい】** に移動します。  を押して選択します。

4  または  を押して **【WAVE】** に移動します。  を押して選択します。

5  を押して、**【サーバー アドレス】** を選択します。  を押してサーバー アドレスを変更します。  を押して選択します。

6  を押して **【ユーザー ID】** に移動します。  を押してサーバー アドレスを変更します。  を押して選択します。

7  を押して【パスワード】に移動します。  を押して **WAVE** のパスワードを表示または変更します。  を押して選択します。

8  を押して【てきよう】に移動します。  を押して変更内容を適用します。

ディスプレイにポジティブ ミニ通知が一時的に表示された後で、【きのうせってい】画面に戻ります。

WAVE グループ通話の発信

1 必要なグループのエイリアスまたは ID の **WAVE** チャンネルを選びます。

2 **PTT** ボタンを押して通話を発信します。

緑色の **LED** が点灯します。テキスト行の 1 行目に【グループコール】アイコンとエイリアスが表示されます。テキスト行の 2 行目に、**WAVE** グループエイリアスが表示されます。

3 以下のいずれか 1 つの手順を実行します。

- 通話許可トーンが完了するまで待機し、マイクに向かってはっきりと話します (有効な場合)。
 - **PTT** サイドトーンが完了するまで待機し、マイクに向かってはっきりと話してください (有効な場合)。
-

4 相手の声を聞くには、**PTT** ボタンを放します。

相手先の無線機が応答すると、**LED** が緑色に点灯します。ディスプレイに【グループコール】アイコン、エイリアスまたは ID と、送信側無線機のエイリアスまたは ID が表示されます。

5 チャンネルフリー指示機能が有効な場合、送信無線機で【**PTT**】ボタンが離された瞬間に、短い警告トーンが鳴ります。これは、そのチャンネルが応答できるようになったことを示します。電話に応答するには、【**PTT**】ボタンを押します。

音声アクティビティがないまま、事前に定められた時間が経過すると、通話が終了します。通話を開始する前の画面に戻ります。

Capacity Max の操作

Capacity Max は制御チャンネルベースのトランキング無線システムです。このシステムで無線機ユーザーが利用可能な機能については、この章で取り扱います。

プッシュトゥトーク (PTT) ボタン

PTT ボタンには基本的に 2 つの目的があります。

- 通話中に **PTT** ボタンを使用して、通話に加わっている他の無線機に送信できます。**PTT** ボタンを押すと、マイクが有効になります。
- 通話中でないときは、新規通話を発信するために **[PTT]** ボタンを使用します。

話すには、**PTT** ボタンを長押しします。相手の声を聞くには、**PTT** ボタンを放します。

通話許可トーンまたは **PTT** サイドトーン が有効となっている場合、短い警告トーンが終了してから話します。

お使いの無線機でチャンネルフリー通知機能が有効になっている (ディーラーによってプログラムされている) 場合、ターゲットの無線機 (通話を受けている無線機) で **[PTT]** ボタンが放された瞬間に、短いアラート トーンが鳴ります。こ

れは、そのチャンネルが空いて、応答できるようになったことを示します。

通話が中断されると、継続した通話禁止音が聞こえます。たとえば、無線機が緊急コールを受信する場合などです。**[PTT]** ボタンを放す必要があります。

プログラム可能ボタン

ディーラーは、プログラム可能ボタンに対して、ボタンを押す長さごとに、無線機能へのショートカットをプログラムできます。

短押し

押してすぐに離します。

長押し

プログラムされた時間の間、押し続けます。



注記:

[きんきゅう] ボタンを押す長さをプログラミングする方法については、「[緊急操作 ページ 430](#)」を参照してください。

指定可能な無線機機能

無線機の以下の機能は、ディーラーまたはシステム管理者がプログラム可能なボタンに割り当てることができます。

音声アンビエンス

無線機が動作する環境をユーザーが選択できます。

音声プロフィール

優先される音声プロフィールをユーザーが選択できます。

Bluetooth® オーディオ切り替え

内部無線機スピーカと外部 Bluetooth 対応アクセサリの間のオーディオルーティングを切り替えます。

Bluetooth 接続

Bluetooth の検出と接続の動作を開始します。

Bluetooth 切断

無線機と Bluetooth 対応デバイス間のすべての既存の Bluetooth 接続を終了します。

Bluetooth 検出可能

無線機を Bluetooth 検出可能モードに切り替えることができます。

連絡先

連絡先リストに直接アクセスできます。

ページング

連絡先リストに直接アクセスして、ページングの送信先となる連絡先を選択できるようにします。

通話履歴

通話履歴のリストを選択します。

緊急

プログラムに応じて、緊急通話を始動またはキャンセルします。

外部パブリック アドレス (PA)

接続した PA ラウドスピーカ増幅器と無線機の内部 PA システムの間のオーディオルーティングを切り替えます。

ホーム チャンネルのリセット

新規ホーム チャンネルを設定します。

ホーム チャンネル リマインダのミュート

ホーム チャンネル リマインダをミュートします。

屋内位置

屋内位置のオンとオフを切り替えます。

Int オーディオ

インテリジェント オーディオのオンとオフを切り替えます。

ダイヤル

無線機の ID を入力して個別コールを開始します。

サイトのしゅどうローミング

手動サイト検索を開始します。

Mic AGC

内部マイクの自動ゲイン制御 (AGC) のオンとオフを切り替えます。

通知

通知リストに直接アクセスできます。

ワンタッチ アクセス

事前に定義したブロードキャスト コール、個別コール、電話通話、グループ コール、ページングまたはクイックテキストメッセージを直接開始します。

オプション ボード機能

オプション ボード対応チャンネルで、オプション ボード機能のオンとオフを切り替えます。

電話

電話連絡先リストに直接アクセスできます。

プライバシー

秘話モードのオンとオフを切り替えます。

パブリック アドレス (PA)

無線機の内部 PA システムのオンとオフを切り替えます。

無線エイリアスと ID

無線エイリアスと ID を提供します。

リモート モニタ

インジケータを表示せずにターゲットの無線機のマイクをオンにします。

サイト情報

現在の Capacity Max サイトの名前と ID を表示します。

音声ガイドが有効になっているときに、現在のサイトの音声ガイドメッセージを再生します。

サイト ロック

オンに切り替えた場合、無線機は現在のサイトのみを検索します。オフに切り替えた場合、無線機は現在のサイトに加え、他のサイトも検索します。

テレメトリ コントロール

ローカルまたはリモート無線機で、出力ピンをコントロールします。

テキスト メッセージ

テキスト メッセージ メニューを選択します。

通話の優先度を切り替えます

無線機の、通話優先度: 高/通常への切り替えを可能にします。

トリル拡張

トリル拡張のオンとオフを切り替えます。

音声ガイド オン/オフ

音声ガイドのオンとオフを切り替えます。

チャンネルの音声ガイド

現在のチャンネルのゾーンとチャンネルアナウンス音声メッセージを示します。この機能は、音声ガイド機能が無効のときは使用できません。

WiFi

Wi-Fi のオンとオフを切り替えます。

ゾーンせんたく

ゾーンのリストからの選択を可能にします。

指定可能な設定またはユーティリティ機能

無線機の以下の設定またはユーティリティ機能をプログラム可能なボタンに割り当てることができます。

トーン/アラート

全トーンとアラートのオンとオフを切り替えます。

バックライト

ディスプレイ バックライトのオンとオフを切り替えます。

チャンネル アップ/ダウン

プログラムに従い、チャンネルを次のチャンネルまたは前のチャンネルに切り替えます。

表示モード

ダイナイト表示モードのオンとオフを切り替えます。



出力レベル



送信出力レベルの高低を切り替えます。

プログラムされた機能へのアクセス

下記の手順に従って、無線機でプログラムされた機能にアクセスします。

- 以下のいずれか 1 つの手順を実行します。
 - プログラムされたボタンを押します。ステップ 3 に進みます。
 -  を押してメニューにアクセスします。

-  または  を押してメニュー機能に移動したら、 を押して機能を選択するか、サブメニューに移動します。

- 以下のいずれか 1 つの手順を実行します。
 -  を押して前の画面に戻ります。
 - ホーム画面に戻るには、 を長押しします。

一定の期間操作しないと、無線機は自動的にメニューを終了し、ホーム画面に戻ります。

メニュー ナビゲーション ボタンはキーパッド付きマイクにもあります。「[キーパッドマイク ボタン ページ 36](#)」を参照してください。

ステータス インジケータ





この章では、無線機で使用するステータス インジケータおよびオーディオトーンについて説明します。

アイコン





無線機の液晶ディスプレイ (LCD) には、無線機の状態、テキスト エントリ、メニュー エントリが表示されます。

表 2: ディスプレイ アイコン

次のアイコンは、無線機ディスプレイ上部のステータス バーに表示されます。アイコンは外観や使用法の順に左詰め配列され、チャンネル固有です。

	<p>BeiDou のみ利用可能¹ BeiDou のみの機能が有効になります。測位を利用できる場合、アイコンは表示されたままになります。</p>
	<p>Bluetooth 接続 Bluetooth 機能が有効です。リモートの Bluetooth デバイスが接続されている間、アイコンは表示されたままになります。</p>
	<p>Bluetooth 未接続 Bluetooth の機能は有効ですが、接続されているリモートの Bluetooth デバイスはありません。</p>
	<p>DGNA 無線機は DGNA グループに入っています。</p>
	<p>緊急 無線機が緊急モードです。</p>



¹ XiR M8660i/XiR M8668i/CM7668i にのみ適用されます。

	<p>GNSS 有効 GNSS 機能が有効です。測位を利用できる場合、アイコンは表示されたままになります。</p>
	<p>GNSS は利用不可 GNSS 機能は有効ですが、衛星からデータを受信していません。</p>
	<p>大量データ 大量データを受信中で、チャンネルがビジーです。</p>
	<p>屋内位置利用可能² 屋内位置ステータスがオンで利用可能です。</p>
	<p>屋内位置利用不可² Bluetooth が無効か、ビーコン スキャンが Bluetooth により一時停止しているため、屋内位置ステータスがオンですが利用できません。</p>

	<p>ミュートモード ミュートモードが有効になると、スピーカがミュートされます。</p>
	<p>通知 通知リストに、1つ以上の不在イベントがあります。</p>
	<p>オプションボード オプションボードが有効です。(オプションボード対応モデルのみ)。</p>
	<p>オプションボード非動作 オプションボードが無効です。</p>
	<p>無線 (Over-the-Air) プログラミング遅延タイム 無線機の自動再起動までの残り時間を示します。</p>
	<p>優先度 1 優先度 1 のグループを示します。</p>

² 最新のソフトウェアおよびハードウェアを搭載したモデルにのみ適用されます。

	優先度 2 優先度 2 のグループを示します。
	受信信号強度インジケータ (RSSI) 表示されるバーの数は、無線機の信号強度を表します。バーが 4 本のときが最大強度です。このアイコンは受信時のみに表示されます。
	応答禁止 応答禁止が有効化されます。
	着信音のみ 呼出音モードが有効です。
	セキュア 秘話モード機能が有効です。
	共有の周波数 無線機が共有のコントロール チャネルに対してロックされていることを示します。
	サイレントモード サイレント呼出音モードが有効です。

	サイトローミング サイトローミング機能が有効です。
	ステータス 新規ステータス メッセージを示します。
	トーン無効 トーンがオフです。
	非セキュア 秘話モード機能が無効です。
	Wi-Fi 優良³ Wi-Fi 信号が優良です。
	Wi-Fi 良好³ Wi-Fi 信号が良好です。
	Wi-Fi 標準³ Wi-Fi 信号が平均的です。
	Wi-Fi 不良³ Wi-Fi 信号が不良です。

³ XiR M8668i/CM7668i にのみ適用されます。

**Wi-Fi 利用不能³**

Wi-Fi 信号を利用できません。

表 3: 高度なメニュー アイコン

以下のアイコンは、2つのオプションのいずれかを選択できるメニュー項目の隣に表示されるか、2つのオプションがあるサブメニューがあることを示すために表示されます。



チェックボックス (チェックされている)
オプションが選択されていることを示します。



チェックボックス (空)
オプションが選択されていないことを示します。



黒く塗りつぶされたボックス
そのメニュー項目のサブメニューで、オプションが選択されていることを示します。

表 4: Bluetooth デバイス アイコン

以下のアイコンも、デバイス タイプを示すために使用できる Bluetooth 対応デバイス リストで項目の隣に表示されません。



Bluetooth オーディオ デバイス
Bluetooth 対応オーディオ デバイス (ヘッドセットなど)。



Bluetooth データ デバイス
Bluetooth 対応データ デバイス (スキャナなど)。







Bluetooth PTT デバイス
Bluetooth 対応 PTT デバイス (PTT のみデバイス (POD) など)。

表 5: 通話アイコン

以下は、通話中にディスプレイに表示されるアイコンです。これらのアイコンは、[れんらく さき] リストにも表示され、エイリアスや ID タイプを示します。



Bluetooth PC コール
Bluetooth PC コール中であることを示します。

	<p>[れんらくさき] リストでは、Bluetooth PC コール エイリアス (名前) または ID (番号) を示します。</p>
	<p>通話優先度: 高 通話優先度: 高が有効であることを示します。</p>
	<p>DGNA 通話 DGNA 通話中であることを示します。</p>
	<p>[ディスパッチ コール] 連絡先タイプのディスパッチ コールは、サードパーティのテキストメッセージ サーバーを介して、ディスパッチャ PC にテキスト メッセージを送信するために使用されます。</p>
	<p>グループ コール/一斉コール グループ コール中または一斉コール中であることを示します。 [れんらくさき] リストでは、グループのエイリアス (名前) または ID (番号) を示します。</p>









	<p>個別コール 個別コール中であることを示します。 [れんらくさき] リストでは、無線機のエイリアス (名前) または ID (番号) を示します。</p>
	<p>グループ コール/一斉コールとしての通話 グループ コールまたは一斉コールとして通話中であることを示します。 [れんらくさき] リストでは、グループのエイリアス (名前) または ID (番号) を示します。</p>
	<p>個別コールとしての通話 個別コールとして通話中であることを示します。 [れんらくさき] リストでは、電話のエイリアス (名前) または ID (番号) を示します。</p>

表 6: JOB チケットアイコン

次のアイコンは、JOB チケット フォルダ内で、ディスプレイに一時的に表示されます。

	すべてのジョブ リストされているすべてのジョブを示します。
	新しいジョブ 新しいジョブを示します。
	処理中 ジョブの送信中です。これが表示された後で、JOB チケットの送信失敗または送信完了が示されます。
	送信失敗 ジョブを送信できませんでした。
	送信完了 ジョブが正常に送信されました。
	優先度 1 ジョブの優先度が 1 であることを示します。



	優先度 2 ジョブの優先度が 2 であることを示します。
	優先度 3 ジョブの優先度が 3 であることを示します。

表 7: ミニ通知アイコン

次のアイコンは、タスクを実行するアクションが行われた後で、ディスプレイに瞬時的に表示されます。













	送信に失敗 (ネガティブ) アクションに失敗しました。
	送信に成功 (ポジティブ) アクションに成功しました。
	通信処理中 (経過) 送信中です。これは、通信に成功または失敗したという表示の前に表示されます。

表 8: 送信済みアイテム アイコン

以下のアイコンは、ディスプレイ右上隅にある送信 BOX フォルダに表示されます。

 また  は	<p>処理中</p> <p>送信機のエイリアスまたは ID に対するメッセージの送信は保留中で、承認を待っている状態です。</p> <p>グループのエイリアスまたは ID に対するメッセージの送信が保留中です。</p>
 また  は	<p>読み込まれた個別メッセージまたはグループメッセージ</p> <p>メッセージが読み込まれました。</p>
 また  は	<p>読み込まれていない個別メッセージまたはグループメッセージ</p> <p>メッセージが読み込まれませんでした。</p>
 また  は	<p>送信失敗</p> <p>テキストメッセージを送信できません。</p>

 また  は	<p>送信完了</p> <p>メッセージは正常に送信されました。</p>
---	---

LED インジケータ

LED インジケータは、無線機の操作ステータスを示します。

赤色の点滅

電源投入時のセルフテストに失敗しました。

緊急送信を受信しています。

低バッテリー状態で送信しています。

オートレンジトランスポンダシステムで設定されている通信範囲から外れました。

ミュートモードが有効です。

緑色の点灯

無線機が電源オンになっています。

送信しています。

無線機はページングまたは緊急送信を送信しています。

緑色の点滅

通話またはデータを受信しています。

エア接続でエア接続プログラミング送信を取得しています。

エア接続アクティビティを検出しています。



注記:

このアクティビティによるプログラム済みチャネルへの影響は、デジタルプロトコルの特性によって異なります。

緑色の2回点滅

秘話モード対応通話またはデータを受信しています。

黄色の点灯

無線機が Bluetooth 検出可能モードになっています。

黄色の点滅

ページングにまだ応答していません。

黄色の2回点滅

自動ローミング機能が有効です。

新規サイトを検索しています。

グループのページングにまだ応答していません。

ロックされています。

トーン

以下は、無線機のスピーカから鳴るトーンです。



高いトーン



低いトーン

オーディオ トーン

オーディオ トーンは、無線機の状態や無線機が受信したデータへの応答を音で知らせます。



連続トーン

モノトーン音。終了まで連続音が鳴ります。



定期トーン

無線機で設定した期間、定期的に音が鳴ります。トーンが開始、中止、反復されます。



反復トーン

ユーザーが停止するまで、シングル トーンが繰り返されます。



瞬間トーン

無線機で設定した短いトーンが 1 回鳴ります。

インジケータ トーン

タスクを実行するアクションが行われた後、インジケータ トーンによりステータスが音声で通知されます。



ポジティブ インジケータ トーン



ネガティブ インジケータ トーン

登録

ユーザーは、登録に関連するさまざまなメッセージを受け取る可能性があります。

登録中

通常、登録情報は電源投入中、グループの変更中、またはサイト ローミング中にシステムに送信されます。サイトでの登録に失敗すると、無線機は自動的に別のサイトへのローミングを試みます。登録が試みられたサイトは、無線機によってローミングリストから一時的に削除されます。

これは、無線機がローミング用サイトの検索のためにビジーであるか、無線機がサイトを発見し、無線機からの登録メッセージに対する応答を待っているということを意味します。

【とうろくちゅう】が無線機に表示されている間は、トーンが鳴り、黄色の LED が 2 回ずつ点滅してサイトを検索していることが示されます。

この状態が終わらない場合、ユーザーは別の場所に移動したり、可能であれば、手動で別のサイトにローミング接続する必要があります。

サービス圏外

無線機がシステムまたは現在のサイトから信号を検出できない場合、この無線機はサービス圏外にあるとみなされます。通常は、無線機が地理的に発信無線周波数 (RF) サービスエリア外にあることを意味します。

【けんがい】が無線機に表示されている間は、トーンが繰り返し鳴り、LED が赤く点滅します。

良好な RF サービスエリア内でも無線機に圏外と表示されるようであれば、お近くの販売店またはシステム管理者にお問い合わせください。

グループへの参加失敗

無線機は登録中に、チャンネルまたは UKP (Unified Knob Position) に指定されたグループへの参加を試みます。

参加失敗状態にある無線機は、参加を試みているグループと受信も発信もできません。

無線機がグループへの参加に失敗すると、ホーム画面に【UKP エイリアス】と表示され、背景が強調表示されます。

無線機に参加失敗の表示がされる場合、お近くの販売店またはシステム管理者までお問い合わせください。

登録拒否

システムへの登録が承諾されない場合、登録拒否を示すインジケータが表示されます。

無線機は、登録拒否の理由を個別に表示しません。一般には、システムオペレータがシステムへの無線機のアクセスを無効にすると、登録が拒否されます。

無線機が登録拒否されているときは、無線機に【とうろくきよひ】と表示され、黄色のLEDが2回ずつ点滅してサイトを検索していることが示されます。

ゾーンとチャネルの選択





この章では、無線機でゾーンまたはチャネルを選択する操作について説明します。



最大 250 個の Capacity Max ゾーンを無線機にプログラムでき、1 ゾーンの最大チャネル数は 160 です。各 Capacity Max ゾーンは、指定可能な位置を最大 16 件含みます。各 Capacity Max ゾーンは、指定可能な位置を最大 16 件含みます。

ゾーンの選択

下記の手順に従って、無線機で必要なゾーンを選択します。





- 1 以下のいずれか 1 つの手順を実行します。
 - プログラムされた【ゾーンせんたく】ボタンを押します。ステップ 3 に進みます。
 -  を押してメニューにアクセスします。

- 2  または  を押して【ゾーン】に移動します。 を押して選択します。
ディスプレイに  と現在のゾーンが表示されます。

- 3  または  を押して必要なゾーンに移動します。 を押して選択します。
ディスプレイに【<ゾーン> せんたくずみ】が一時的に表示され、すぐに選択されたゾーンの画面に戻ります。

エイリアス検索を使用したゾーンを選択

下記の手順に従って、エイリアス検索を使用して、無線機で必要なゾーンを選択します。

- 1  を押してメニューにアクセスします。
- 2  または  を押して [ゾーン] に移動します。  を押して選択します。
ディスプレイに  と現在のゾーンが表示されます。
- 3 必要なエイリアスの最初の文字を入力します。
ディスプレイに表示されているカーソルが点滅します。
- 4 必要なエイリアスの残りの文字を入力します。
エイリアス検索では、大文字と小文字が区別されません。同じ名前前のエントリが 2 つ以上ある場合、リス

トの最初に記載されたエントリがディスプレイに表示されます。

テキスト行の 1 行目に入力した文字が表示されません。テキスト行の次の行に検索結果の短い一覧が表示されます。

- 5  を押して選択します。

ディスプレイに [<ゾーン> せんとくずみ] が一時的に表示され、すぐに選択されたゾーンの画面に戻ります。

通話タイプの選択

チャンネルセレクトタノブを使用して通話タイプを選択します。無線機のプログラム方法に応じてグループコール、ブロードキャストコール、一斉コール、または個別コールを選択可能です。チャンネルセレクトタノブを異なる位置 (通話タイプが割り当てられている位置) に変更する場合、無線機を **Capacity Max System** に再登録することになります。無線機は、新しいチャンネルセレクトタノブ位置の通話タイプにプログラムされているグループ ID に登録します。

プログラムされていないチャンネルを選択した場合、無線機は動作しないため、選択せずにチャンネルセレクトタノブを使

用して、プログラムされているチャンネルを選択してください。

必要なゾーンが表示されたら (無線機に複数のゾーンがある場合)、プログラムされているチャンネル セクタノブを回して 通話タイプを選択します。

サイトの選択

1つのサイトは、特定の1エリアの通信範囲を規定します。マルチサイト ネットワークでは、現在のサイトからの信号レベルが受容できないレベルまで下がると、Capacity Max 無線機は、新しいサイトを自動的に検索します。

Capacity Max システムは、最大 250 サイトをサポートできます。

ローミング要求

ローミング要求は、現在のサイトからの信号が十分であっても、異なるサイトを検索するよう無線機に指示します。

使用可能なサイトが存在しない場合:

- 無線機に「けんさくちゆう」と表示され、サイト リストの検索が継続されます。

- 前のサイトがまだ使用できる場合は、無線機が前のサイトに戻ります。



注記:

ディーラーがプログラムします。

プログラムされた **【手動ローミング】** ボタンを押しません。

無線機が新しいサイトに切り替わったことを示すトーンが聞こえます。ディスプレイに「**【サイト ID < サイト番号 >】**」が表示されます。

サイト ロック オン/オフ

オンに切り替えた場合、無線機は現在のサイトのみを検索します。オフに切り替えた場合、無線機は現在のサイトに加え、他のサイトも検索します。

プログラムされた **【サイト ロック】** ボタンを押しません。

【サイト ロック】 機能をオンに切り替えると、

- ポジティブ インジケータ トーンが聞こえて、無線機が現在のサイトにロックされていることを示しています。

- ディスプレイに【サイト ロックずみ】と表示されます。

【サイト ロック】機能をオフに切り替えると、

- ネガティブ インジケータ トーンが聞こえます。無線機のロックが解除されていることを示しています。
- ディスプレイに【サイト ロックかいじょ】と表示されます。

サイト制限

Capacity Max システムでは、無線機のシステム管理者が、無線機の使用を許可するネットワーク サイトと禁止するネットワーク サイトを決定できます。

許可サイトと禁止サイトのリストを変更するために、無線機をプログラミングし直す必要はありません。禁止されているサイトで無線機が登録を試みると、無線機はこのサイトが禁止されていることを示す応答を受信します。その後、無線機では、異なるネットワーク サイトが検索されます。

サイトの制約が発生すると、無線機に【とうろくきよひ】と表示され、黄色の LED が 2 回ずつ点滅してサイトを検索していることが示されます。

サイト トランキング

サイトがシステム トランキングとみなされるためには、トランク コントローラと通信できる必要があります。

サイトがシステムのトランク コントローラと通信できない場合、無線機はサイト トランキング モードになります。サイト トランキング モードの無線機は、定期的に音声および表示による通知を行って、機能が制限されていることをユーザーに知らせます。

サイト トランキング モードの場合、無線機に【サイト トランキング】と表示され、反復トーンが鳴ります。

サイト トランキング モードの無線機は、グループおよび個別の音声通話を行うことも、同じサイト内の他の無線機にテキスト メッセージを送信することもできます。音声コンソール、ロギングレコーダ、電話ゲートウェイ、およびデータ アプリケーションが同サイトの無線機と通信することはできません。

複数サイトにまたがる通話に参加している無線機がサイト トランキング モードになると、同じサイト内の他の無線機としか通信できなくなります。他のサイトとの通信は失われます。

**注記:**

無線機の現在の位置をサービス対象エリアとするサイトが複数あり、いずれかのサイトがサイト トランキングモードになると、そのサイトの無線機は、圏内にある別のサイトにローミングします。

通話

この章では、通話の受信、応答、発信、停止の操作について説明します。

以下の機能のいずれかを使用してチャンネルを選択した後、無線機のエイリアスまたは ID、あるいはグループのエイリアスまたは ID を選択できます。

エイリアス検索

この方法は、キーパッド マイクを併用して、グループコール、個別コール、および一斉コールのみに使用します。

連絡先リスト

この方法では、連絡先リストに直接アクセスできます。

ダイアル (連絡先を使用)

この方法は、キーパッド マイクを併用して、個別コールおよび通話のみに使用します。

プログラム可能な数値キー

この方法は、キーパッド マイクを併用して、グループコール、個別コール、および一斉コールのみに使用しません。

**注記:**

各数値キーに割り当てできるのは単一のエイリアスまたは ID ですが、単一のエイリアスまたは ID は、複数の数値キーに関連付けできます。キーパッド マイクのすべての数値キーに割り当てできます。詳細については、「[プログラム可能な数値キーへのエントリの割り当て ページ 415](#)」を参照してください。

プログラムされた [ワン タッチ アクセス] ボタン

この方法は、グループコール、個別通話、および電話通話のみに使用します。

ワン タッチ アクセス ボタンでは、プログラム可能ボタンの短押しまたは長押しに、それぞれ単一の ID のみを割り当てできます。お使いの無線機で、複数の [ワン タッチ アクセス] ボタンをプログラムできます。

プログラム可能ボタン

この方法は、通話のみに使用します。

音量/チャンネルセレクト ノブ

この方法では、無線機のエイリアスまたは ID、あるいはグループのエイリアスまたは ID が手動で選択されます。

無線機が送信している間は緑色の LED が点灯し、無線機が受信している間は緑色に点滅します。



注記:

無線機が送信している間は緑色の LED が点灯し、無線機が秘話対応通話を受信している際には 2 回点滅します。

秘話対応通話のスクランブルを解除するには、無線機に送信側無線機 (受信中の通話の相手) と同一のプライバシー キー、または同一のキー値とキー ID (ディーラーがプログラミング) が設定されている必要があります。

詳細については、「[プライバシー ページ 468](#)」を参照してください。

グループ通話

ユーザー グループとの通話を受信/発信するには、無線機をそのグループの所属に設定する必要があります。

グループ通話の発信

ユーザーのグループに通話を発信するには、無線機がそのグループの一部として設定されている必要があります。下記の手順に従って、無線機でグループ コールを発信します。

- 1 以下のいずれか 1 つの手順を実行します。
 - アクティブなグループのエイリアスまたは ID のチャンネルを選択します。「[通話タイプの選択 ページ 59](#)」を参照してください。
 - プログラムされた [**ワンタッチ アクセス**] ボタンを押します。

-
- 2 **PTT** ボタンを押して通話を発信します。

緑色の LED が点灯します。テキスト行の 1 行目に [**グループ コール**] アイコンとエイリアスが表示されます。

-
- 3 以下のいずれか 1 つの手順を実行します。

- 通話許可トーンが完了するまで待機し、マイクに向かってはっきりと話します (有効な場合)。
- **PTT** サイドトーンが完了するまで待機し、マイクに向かってはっきりと話してください (有効な場合)。

- 4 相手の声を聞くには、**PTT** ボタンを放します。

相手先の無線機が応答すると、**LED** が緑色に点灯します。ディスプレイに **[グループ コール]** アイコン、エイリアスまたは **ID** と、送信側無線機のエイリアスまたは **ID** が表示されます。

- 5 チャンネルフリー指示機能が有効な場合、送信無線機で **[PTT]** ボタンが離された瞬間に、短い警告トーンが鳴ります。これは、そのチャンネルが応答できるようになったことを示します。電話に応答するには、**[PTT]** ボタンを押します。



音声アクティビティがないまま、事前に定められた時間が経過すると、通話が終了します。



通話の発信者は  を押して、グループ コールを終了できます。

連絡先リストを使用したグループコールの発信

下記の手順に従って、連絡先リストを使用して無線機でグループ コールを発信します。

- 1  を押してメニューにアクセスします。

- 2  または  を押して **[れんらくさき]** に移動します。  を押して選択します。

- 3  または  を押して必要なエイリアスまたは **ID** に移動します。  を押して選択します。

- 4 **PTT** ボタンを押して通話を発信します。

緑色の **LED** が点灯します。

1 行目に、無線機のエイリアスまたは **ID** が表示されます。2 行目には、**[グループ コール]** と **[グループ コール]** アイコンが表示されます。

- 5 以下のいずれか 1 つの手順を実行します。

- 通話許可トーンが完了するまで待機し、マイクに向かってはっきりと話します (有効な場合)。
- **PTT** サイドトーンが完了するまで待機し、マイクに向かってはっきりと話してください (有効な場合)。

6 相手の声を聞くには、**PTT** ボタンを放します。

グループ内のユーザーが応答すると、LED が緑色に点滅します。ディスプレイに【グループ コール】アイコン、エイリアスまたは ID と、送信側無線機のエイリアスまたは ID が表示されます。

7 チャンネルフリー指示機能が有効な場合、送信無線機で **[PTT]** ボタンが離された瞬間に、短い警告トーンが鳴ります。これは、そのチャンネルが応答できるようになったことを示します。電話に応答するには、**[PTT]** ボタンを押します。

音声アクティビティがないまま、事前に定められた時間が経過すると、通話が終了します。

通話発信者は  を押して、グループ コールを終了できます。

短いトーンが聞こえます。ディスプレイに【コール しゅうりょう】と表示されます。

プログラム可能な数値キーを使用したグループ コールの発信

下記の手順に従って、プログラム可能な数値キーを使用して無線機でグループ コールを発信します。

1 ホーム画面が表示されている場合、プログラム可能な数値キーを長く押すと、事前に定義されたエイリアスまたは ID が表示されます。

数値キーが特定のモードのエントリに割り当てられている場合、別のモードで数値キーを長く押しても、この機能は使用できません。

数値キーがエントリに割り当てられていない場合、ネガティブインジケータトーンが鳴ります。

2 **PTT** ボタンを押して通話を発信します。

緑色の LED が点灯します。

3 相手の声を聞くには、**PTT** ボタンを放します。

グループ内のユーザーが応答すると、LED が緑色に点滅します。

4 チャンネルフリー指示機能が有効な場合、送信無線機で **[PTT]** ボタンが離された瞬間に、短い警告トーンが鳴ります。これは、そのチャンネルが応答できるようになったことを示します。電話に応答するには、**[PTT]** ボタンを押します。

音声アクティビティがないまま、事前に定められた時間が経過すると、通話が終了します。通話を開始する前の画面に戻ります。



通話発信者は  を押して、グループ コールを終了できます。

詳細については、「[プログラム可能な数値キーへのエントリの割り当て ページ 415](#)」を参照してください。



エイリアス検索を使用したグループ コールの発信

エイリアスや英数字検索を使用して、必要な無線機のエイリアスを取得することもできます。この機能は、[れんらくさき] のみに適用されます。下記の手順に従って、エイリアス検索を使用して通話を発信します。



- 1  を押してメニューにアクセスします。





- 2  または  を押して [れんらくさき] に移動します。  を押して選択します。

ディスプレイにアルファベット順でエントリが表示されます。

- 3  または  を押して、必要な無線機のエイリアスまたは ID に移動します。ディスプレイの 1 行目に [ばんごう:] と表示されます。ディスプレイの 2 行目に、点滅するカーソルが表示されます。キーパッドを使用して、電話番号を入力します。

- 4  を押して選択します。選択したエントリが空の場合、ネガティブ インジケータ トーンが鳴り、ディスプレイに [つうわむこうなばんごう] と表示されます。

- 5  または  を押して [つうわ] に移動し、  を押して選択します。。アクセス コードが連絡先リストで事前に設定されていない場合、ディスプレイの 1 行目に [アクセス コード:] と表示されます。ディスプレイの 2 行目に、点滅するカーソルが



表示されます。アクセスコードを入力し、 ボタンを押して先に進みます。成功すると、DTMF トーンが鳴ります。電話機ユーザーのダイアルトーンが聞こえます。ディスプレイの 1 行目に、無線機のエイリアスまたは ID と  アイコンが表示されます。ディスプレイの 2 行目に【でんわつうわ】および  アイコンが表示されます。失敗の場合、トーンが鳴り、ディスプレイに【でんわ NG】と表示されます。アクセスコード入力画面に戻ります。アクセスコードが  リストで事前に設定されている場合、そのコールを開始する前の画面に戻ります。

6 話すときには **PTT** ボタンを押し、聞くときにはボタンを放します。送信中は  アイコンが消えます。

7 電話通話中に追加の数字を入力する必要がある場合は、次のいずれか 1 つの手順を実行します。

- キーボードのいずれかのキーを押し、追加の数字の入力を始めます。ディスプレイの 1 行目に【つかケタ:】と表示されます。ディスプレイの 2 行目に、点滅するカーソルが表示されます。追加の数字を入力し、 を押して、先に進みます。DTMF トーンが鳴り、前の画面に戻ります。

- **ワンタッチアクセス** ボタンを押します。DTMF トーンが鳴ります。**ワンタッチアクセス** ボタンのエントリが空の場合、ネガティブインジケータトーンが鳴ります。

- 8 通話を終了するには、 を押します。アクセスコードが連絡先リストで事前に設定されていない場合、ディスプレイの 1 行目に【ディアクセスコード:】と表示されます。ディスプレイの 2 行目に、点滅するカーソルが表示されます。ディアクセスコードを入力し、 を押して先に進みます。前の画面に戻ります。DTMF トーンが鳴り、ディスプレイに【でんわせつだん】と表示されます。成功の場合、トーンが鳴り、ディスプレイに【でんわしゅうりょう】と表示されます。電話通話画面に戻ります。失敗した場合、無線機は電話通話画面に戻ります。電話連絡先画面で **PTT** ボタンを押すと、トーンが鳴り、ディスプレイに【コール OK】と表示されます。電話機ユーザーが通話を終了するとトーンが鳴り、ディスプレイに【でんわしゅうりょう】と表示されます。電話通話でリクエストされた追加の数字を入力している間に通話が終了した場合、その通話を開始する前の画面に戻ります。



- 9 チャンネルフリー指示機能が有効な場合、送信無線機で **[PTT]** ボタンが離された瞬間に、短い警告トーンが鳴ります。これは、そのチャンネルが応答できるようになったことを示します。電話に応答するには、**[PTT]** ボタンを押します。

音声アクティビティがないまま、事前に定められた時間が経過すると、通話が終了します。トーンが鳴ります。ディスプレイに「**コールしゅうりょう**」と表示されます。

通話発信者は  を押して、グループ コールを終了できます。



注記:

チャンネル アクセス中に  を押して、コール試行とトーン音ボタンを解除するか、エイリアス検索を終了します。エイリアス検索を終了するには、

ボタンまたは  を押します。コール中、ディアクセスコードが事前設定されている状態で **ワンタッチアクセス** ボタンを押すか、追加の数字の入力としてディアクセスコードを入力すると、コールの終了が試行されます。チャンネルアクセスおよびアクセス/ディアクセスコードまたは追加の数字の送信中は、無線機は、オン/オフ ボタン、音量コントロールノブ、およびチャンネルロッカーにのみ反応します。無効な入力を行うたびにトーンが鳴ります。

グループ コールへの応答

下記の手順に従って、無線機でグループ コールに応答します。

グループ コールを受信した場合:

- 緑色の LED が点滅します。
- ディ스플레이の右上隅に **[グループ コール]** アイコンが表示されます。

- テキスト行の 1 行目に発信者のエイリアスが表示されます。
- テキスト行の 2 行目に、グループ コール エイリアスが表示されます。
- 無線機のミュートが解除され、着信通話の音はスピーカから聞こえます。

1 以下のいずれか 1 つの手順を実行します。

- チャンネルフリー指示機能が有効な場合、送信無線機で **[PTT]** ボタンが離された瞬間に、短い警告トーンが鳴ります。これは、そのチャンネルが応答できるようになったことを示します。電話に応答するには、**[PTT]** ボタンを押します。
- 音声割り込み機能が有効になっている場合、**[PTT]** ボタンを押して送信側無線機から音声に割り込んで、応答できるようにそのチャンネルを解放します。緑色の LED が点灯します。

2 以下のいずれか 1 つの手順を実行します。

- 通話許可トーンが完了するまで待機し、マイクに向かってはっきりと話します (有効な場合)。

- **PTT** サイドトーンが完了するまで待機し、マイクに向かってはっきりと話してください (有効な場合)。

3 相手の声を聞くには、**PTT** ボタンを放します。

音声アクティビティがないまま、事前に定められた時間が経過すると、通話が終了します。

ブロードキャスト コール

ブロードキャスト コールは、ユーザーからグループ全体に対する一方向の音声通話です。

ブロードキャスト コール機能では、通話を開始したユーザーのみがグループへ送信でき、通話の受信者は応答できません。

ブロードキャストの発信者は、ブロードキャスト コールを終了することもできます。ユーザー グループとの通話を受信/発信するには、無線機がそのグループの一部として設定されている必要があります。

ブロードキャスト コールの発信

下記の手順に従って、無線機でブロードキャスト コールを発信します。

- 1 以下のいずれか 1 つの手順を実行します。
 - アクティブなグループのエイリアスまたは ID のチャンネルを選択します。「[通話タイプの選択 ページ 59](#)」を参照してください。
 - プログラムされた [**ワンタッチ アクセス**] ボタンを押します。

- 2 **PTT** ボタンを押して通話を発信します。

緑色の LED が点灯します。ディスプレイに、**[グループ コール]** アイコンとエイリアスが表示されます。



- 3 以下のいずれか 1 つの手順を実行します。
 - 通話許可トーンが完了するまで待機し、マイクに向かってはっきりと話します (有効な場合)。
 - **PTT** サイドトーンが完了するまで待機し、マイクに向かってはっきりと話してください (有効な場合)。



通話発信者は、 を押して、ブロードキャスト コールを終了できます。

連絡先リストを使用したブロードキャスト コールの発信

下記の手順に従って、連絡先リストを使用して無線機でブロードキャスト コールを発信します。

- 1  を押してメニューにアクセスします。

- 2  または  を押して **[れんらくさき]** に移動します。  を押して選択します。

- 3  または  を押して必要なエイリアスまたは ID に移動します。  を押して選択します。

- 4 **PTT** ボタンを押して通話を発信します。
緑色の LED が点滅します。

1 行目に、無線機のエイリアスまたは ID が表示されます。2 行目には、[グループ コール] と [グループ コール] アイコンが表示されます。

5 以下のいずれか 1 つの手順を実行します。

- 通話許可トーンが完了するまで待機し、マイクに向かってはっきりと話します (有効な場合)。
- **PTT** サイドトーンが完了するまで待機し、マイクに向かってはっきりと話してください (有効な場合)。

通話発信者は、 を押して、ブロードキャスト コールを終了できます。

プログラム可能な数値キーを使用したブロードキャスト コールの発信

下記の手順に従って、プログラム可能な数値キーを使用して無線機でブロードキャスト コールを発信します。

- 1 ホーム画面が表示されている場合、プログラム可能な数値キーを長く押すと、事前に定義されたエイリアスまたは ID が表示されます。

数値キーが特定のモードのエントリに割り当てられている場合、別のモードで数値キーを長く押しても、この機能は使用できません。

数値キーがエントリに割り当てられていない場合、ネガティブ インジケータ トーンが鳴ります。

2 **PTT** ボタンを押して通話を発信します。

緑色の LED が点灯します。ディスプレイの右上隅に [グループ コール] アイコンが表示されます。テキスト行の 1 行目に発信者のエイリアスが表示されます。

3 以下のいずれか 1 つの手順を実行します。

- 通話許可トーンが完了するまで待機し、マイクに向かってはっきりと話します (有効な場合)。
- **PTT** サイドトーンが完了するまで待機し、マイクに向かってはっきりと話してください (有効な場合)。

通話発信者は、 を押して、ブロードキャスト コールを終了できます。

ブロードキャスト コールの受信

下記の手順に従って、無線機でブロードキャスト コールを受信します。

ブロードキャスト コールを受信した場合:

- 緑色の LED が点滅します。
- ディスプレイの右上隅に【グループ コール】アイコンが表示されます。
- テキスト行の 1 行目に発信者のエイリアスが表示されます。
- テキスト行の 2 行目に、グループ コール エイリアスが表示されます。
- 無線機のミュートが解除され、着信通話の音はスピーカから聞こえます。



注記:

ブロードキャスト コール中は、受信ユーザーがトークバックすることはできません。ディスプレイに【トークバック禁止】と表示されます。ブロードキャスト コール中に **PTT** ボタンを押すと、トークバック禁止音が瞬間的に鳴ります。

個別コール

個別コールとは、1 台の無線機から別の 1 台の無線機への通話です。

個別コールには、2 つの設定方法があります。

- 最初の通話タイプは **OACSU (Off Air Call Set-Up)** と呼ばれています。OACSU は、無線機のプレゼンス チェック実施後に通話をセットアップし、通話を自動的に完了します。
- 2 つ目のタイプは **FOACSU (Full Off Air Call Set-Up)** と呼ばれています。FOACSU でも、無線機のプレゼンス チェック実施後に通話をセットアップします。ただし、FOACSU の通話は、通話の完了にユーザーの確認を必要とし、ユーザーは通話を許可するか拒否するかを選択することができます。

通話タイプはシステム管理者が設定します。

**注記:**

通話の発信者と受信者のどちらでも、 を押すことによって、進行中の個別コールを終了できます。

個別通話の発信

個別コールを開始するには無線機をプログラムする必要があります。この機能が無効である場合に通話を開始すると、ネガティブインジケータトーンが鳴ります。下記の手順に従って、無線機で個別コールを発信します。相手の無線機が利用不可の場合、短いトーンが鳴り、ディスプレイに【あいてさきむこう】と表示されます。

- 1 以下のいずれか 1 つの手順を実行します。
 - アクティブな無線機のエイリアスまたは ID のチャンネルを選択します。「[通話タイプの選択 ページ 59](#)」を参照してください。
 - プログラムされた【ワンタッチ アクセス】ボタンを押します。

- 2 **PTT** ボタンを押して通話を発信します。

緑色の LED が点灯します。ディスプレイに【個別通話】アイコン、無線機のエイリアス、通話ステータスが表示されます。

- 3 通話許可トーンが完了するまで待機し、マイクに向かってはっきりと話します (有効な場合)。

- 4 相手の声を聞くには、**PTT** ボタンを放します。
相手先の無線機が応答すると、LED が緑色に点灯します。

- 5 音声アクティビティがないまま、事前に定められた時間が経過すると、通話が終了します。短いトーンが鳴ります。ディスプレイに【コールしゅうりょう】と表示されます。

通話の発信者と受信者のどちらでも、 を押すことによって、進行中の個別コールを終了できます。

プログラム可能な数値キーを使用した個別コールの発信

下記の手順に従って、プログラム可能な数値キーを使用して無線機で個別コールを発信します。

- 1 ホーム画面が表示されている場合、プログラム可能な数値キーを長く押すと、事前に定義されたエイリアスまたは ID が表示されます。

数値キーが特定のモードのエントリに割り当てられている場合、別のモードで数値キーを長く押しても、この機能は使用できません。

数値キーがエントリに割り当てられていない場合、ネガティブインジケータトーンが鳴ります。

2 PTT ボタンを押して通話を発信します。

緑色の LED が点灯します。ディスプレイの右上隅に、**[こべつ コール]** アイコンが表示されます。テキスト行の **1** 行目に発信者のエイリアスが表示されます。テキスト行の **2** 行目に通話ステータスが表示されます。

3 相手の声を聞くには、PTT ボタンを放します。

相手先の無線機が応答すると、LED が緑色に点滅します。宛先のエイリアスが表示されます。



4 音声アクティビティがないまま、事前に定められた時間が経過すると、通話が終了します。短いトーンが鳴ります。ディスプレイに「コールしゅうりょう」と表示されます。

通話の発信者と受信者のどちらでも、 を押すことによって、進行中の個別コールを終了できます。



詳細については、「[プログラム可能な数値キーへのエントリの割り当て ページ 415](#)」を参照してください。

エイリアス検索を使用した個別コールの発信

1  を押してメニューにアクセスします。



2  または  を押して「れんらくさき」に移動します。  を押して選択します。

ディスプレイにアルファベット順でエントリが表示されます。

3  または  を押して必要な無線機のエイリアスまたは ID に移動します。ディスプレイの **1** 行目に「ばんごう」と表示されます。ディスプレイの **2** 行目に、点滅するカーソルが表示されます。キーパッドを使用して、電話番号を入力します。

4  を押して選択します。選択したエントリが空の場合、ネガティブインジケータトーンが鳴り、デ

ディスプレイに【つうわむこうなばんごう】と表示されます。



- 5  または  を押して【通話】に移動し、 を押して選択します。アクセスコードが連絡先リストで事前に設定されていない場合、ディスプレイの1行目に【アクセスコード:】と表示されます。ディスプレイの2行目に、点滅するカーソルが表示

されます。アクセスコードを入力し、 ボタンを押して先に進みます。成功すると、DTMF トーンが鳴ります。電話機ユーザーのダイアルトーンが聞こえます。ディスプレイの1行目に、無線機のエリアスまたは ID と **[RSSI]** アイコンが表示されます。ディスプレイの2行目に【でんわつうわ】および**[電話通話]** アイコンが表示されます。失敗の場合、トーンが鳴り、ディスプレイに【でんわ NG】と表示されます。アクセスコード入力画面に戻ります。アクセスコードが【れんらくさき】リストで事前に設定されている場合、そのコールを開始する前の画面に戻ります。

- 6 話すときには **PTT** ボタンを押し、聞くとときにはボタンを放します。送信中は **[RSSI]** アイコンが消えます。
-

- 7 電話通話中に追加の数字を入力する必要がある場合は、次のいずれか1つの手順を実行します。

- キーボードのいずれかのキーを押し、追加の数字の入力を始めます。ディスプレイの1行目に【ついかケタ:】と表示されます。ディスプレイの2行目に、点滅するカーソルが表示されます。残りの数字を入力し、 を押して、先に進みます。DTMF トーンが鳴り、前の画面に戻ります。
 - **ワンタッチアクセス** ボタンを押します。DTMF トーンが鳴ります。**ワンタッチアクセス** ボタンのエントリが空の場合、ネガティブインジケータトーンが鳴ります。
-

- 8 通話を終了するには、 を押します。アクセスコードが連絡先リストで事前に設定されていない場合、ディスプレイの1行目に【ディアクセスコード:】と表示されます。ディスプレイの2行目に、点滅するカーソルが表示されます。ディアクセスコードを入力し、 を押して先に進みます。前の画面に戻ります。DTMF トーンが鳴り、ディスプレイに【でんわせつだん】と表示されます。成功の場合、トーンが鳴り、ディスプレイに【でんわしゅうりょう】と表示されます。電話通話画面に戻ります。失敗した場合、無線機は電話通話画面に戻ります。電話連



絡先画面で **PTT** ボタンを押すと、トーンが鳴り、ディスプレイに【コール OK】と表示されます。電話機ユーザーが通話を終了するとトーンが鳴り、ディスプレイに【でんわしゅうりょう】と表示されます。通話でリクエストされた追加の数字を入力している間に通話が終了した場合、そのコールを開始する前の画面に戻ります。

- 9 音声アクティビティがないまま、事前に定められた時間が経過すると、通話が終了します。短いトーンが鳴ります。ディスプレイに【コールしゅうりょう】と表示されます。

通話の発信者と受信者のどちらでも、 を押すことによって、進行中の個別コールを終了できます。



注記:

チャンネルアクセス中に  を押すと、コール試行が解除され、トーンが鳴ります。エイリアス検索を終了するには、 ボタンまたは  を押します。コール中、ディアクセスコードが事前設定されている状態で **ワンタッチアクセス** ボタンを押すか、追加の数字の入力としてディアクセスコードを入力すると、コールの終了が試行されます。

ワンタッチ コール ボタンを使用した個別コールの発信

ワンタッチ コール機能を使用すると、事前定義された個別コール エイリアスまたは ID に対する個別コールを簡単に発信できます。この機能は、ボタンを短くまたは長く押すという、プログラム可能なボタンの押し方に割り当てることができます。

ワンタッチ コール ボタンには、エイリアスまたは ID を 1 つのみ割り当てることができます。無線機には、複数のワンタッチ コール ボタンをプログラムできます。







- 1 プログラムされた **[ワンタッチ コール]** ボタンを押し、事前に定義された個別通話エイリアスまたは ID に個別コールを発信します。
- 2 **PTT** ボタンを押して通話を発信します。
LED が緑色で点灯します。
ディスプレイに個別コール エイリアスまたは ID が表示されます。
- 3 通話許可トーンが完了するまで待機し (有効な場合)、マイクに向かってはっきりと話します。



- 4 相手の声を聞くには、**PTT** ボタンを放します。
- ターゲットの無線機が応答すると、**LED** が緑色に点滅します。
- 音声アクティビティがないまま、事前に定められた時間が経過すると、通話が終了します。

通話の発信者と受信者のどちらでも、 を押すことによって、進行中の個別コールを終了できます。



ダイヤルを使用した個別コールの発信

下記の手順に従って、ダイヤルを使用して無線機で個別コールを発信します。

- 1  を押してメニューにアクセスします。
- 2  または  を押して『れんらくさき』に移動します。  を押して選択します。
- 3  または  を押して『ダイヤル』に移動します。  を押して選択します。

- 4  または  を押して『むせんきばんごう』に移動します。  を押して選択します。

- 5 以下のいずれか 1 つの手順を実行します。

- 無線機の ID を入力し、 を押して先に進みます。
- 前にダイヤルした無線機の ID を編集し、 を押して先に進みます。

- 6 **PTT** ボタンを押して通話を発信します。

緑色の **LED** が点灯します。宛先のエイリアスが表示されます。

- 7 通話許可トーンが完了するまで待機し、マイクに向かってはっきりと話します (有効な場合)。

- 8 相手の声を聞くには、**PTT** ボタンを放します。

相手先の無線機が応答すると、**LED** が緑色に点灯します。ディスプレイに送信ユーザーのエイリアスまたは ID が表示されます。

- 9 チャンネルフリー指示機能が有効な場合、送信無線機で **[PTT]** ボタンが離された瞬間に、短い警告トーンが鳴ります。これは、そのチャンネルが応答できるようになったことを示します。電話に応答するには、**[PTT]** ボタンを押します。

音声アクティビティがないまま、事前に定められた時間が経過すると、通話が終了します。トーンが鳴ります。ディスプレイに【コールしゅうりょう】と表示されます。

通話の発信者と受信者のどちらでも、 を押すことによって、進行中の個別コールを終了できます。

個別コールの受信

OACSU (Off Air Call Set-Up) として設定された個別コールを受信する場合:

- 緑色の LED が点滅します。
- 無線機のミュートが解除され、着信通話の音はスピーカから聞こえます。





注記:

無線機の設定方法に応じて、個別コールに応答する OACSU または FOACSU (Full Off Air Call Set-Up) がユーザーの確認応答を必要とする場合と必要としない場合があります。

OACSU 設定では、無線機は自動的にミュートを解除して通話を開始します。

個別コールの受信

FOACSU (Full Off Air Call Set-Up) として設定された個別コールを受信する場合:

- 緑色の LED が点滅します。
 - 1 FOACSU として設定された個別コールを許可するには、次のいずれかを行います。
 -  または  を押して【きよか】に移動し、 を押して個別コールに応答します。
 - 任意のエントリで **PTT** ボタンを押します。
- 緑色の LED が点灯します。

2 通話許可トーンが完了するまで待機し、マイクに向かってはっきりと話します (有効な場合)。





3 相手の声を聞くには、**PTT** ボタンを放します。

音声アクティビティがないまま、事前に定められた時間が経過すると、通話が終了します。トーンが鳴ります。ディスプレイに【コールしゅうりょう】と表示されます。



注記:

通話の発信者と受信者のどちらでも、 を押すことによって、進行中の個別コールを終了できます。

-  または  を押して【きよひ】に移動し、
 を押して個別コールを拒否します。
-  を押して個別コールを拒否します。

一斉コール

一斉コールは、システム設定に応じて、1 台の無線機からサイトの各無線機またはサイト グループの各無線機へのコールです。

一斉コールは、ユーザーの注意を十分に促す必要がある重要な通知に使用されます。システムのユーザーは、一斉コールには応答できません。

Capacity Max は、サイト一斉コールとマルチサイト一斉コールをサポートしています。システム管理者は、無線機でこれらのいずれかまたは両方を設定できます。



注記:

無線機は、システム全体への一斉コールをサポートできますが、**Motorola Solutions** インフラストラクチャは、システム全体への一斉コールをサポートしません。

個別コールの拒否

FOACSU (Full Off Air Call Set-Up) として設定された個別コールを受信する場合:

- 緑色の LED が点滅します。

FOACSU として設定された個別コールを拒否するには、次のいずれかを行います。

一斉コールの発信

一斉コールを発信するには無線機をプログラムする必要があります。下記の手順に従って、無線機で一斉コールを発信します。

- 1 アクティブな一斉コールグループのエイリアスまたは ID があるチャンネルを選択します。「[通話タイプの選択 ページ 59](#)」を参照してください。

- 2 PTT ボタンを押して通話を発信します。

緑色の LED が点灯します。ディスプレイに **[グループコール]** アイコンと、設定の種類に応じて **[いっせいコール]**、**[サイトいっせいコール]**、または **[マルチサイト コール]** のいずれかが表示されます。

- 3 以下のいずれか 1 つの手順を実行します。

- 通話許可トーンが完了するまで待機し、マイクに向かってはっきりと話します (有効な場合)。
- PTT サイドトーンが完了するまで待機し、マイクに向かってはっきりと話してください (有効な場合)。

チャンネルのユーザーは、一斉コールには応答できません。

通話発信者は、 を押して、一斉コールを終了できます。

プログラム可能な数値キーを使用した一斉コールの発信

下記の手順に従って、プログラム可能な数値キーを使用して無線機で一斉コールを発信します。

- 1 ホーム画面が表示されている場合、事前に定義されたエイリアスまたは ID に割り当てられたプログラム可能な数値キーを長く押します。

数値キーが特定のモードのエントリに割り当てられている場合、別のモードで数値キーを長く押しても、この機能は使用できません。

数値キーがエントリに割り当てられていない場合、ネガティブインジケータトーンが鳴ります。

- 2 PTT ボタンを押して通話を発信します。

緑色の LED が点灯します。ディスプレイに **[グループコール]** アイコンと、設定の種類に応じて **[いっせいコール]**、**[サイトいっせいコール]**、または **[マルチサイト コール]** のいずれかが表示されます。

3 以下のいずれか 1 つの手順を実行します。



- 通話許可トーンが完了するまで待機し、マイクに向かってはっきりと話します (有効な場合)。
- **PTT** サイドトーンが完了するまで待機し、マイクに向かってはっきりと話してください (有効な場合)。

通話発信者は、 を押して、一斉コールを終了できます。



詳細については、「[プログラム可能な数値キーへのエントリの割り当て ページ 415](#)」を参照してください。

エリアス検索を使用した一斉コールの発信



1  を押してメニューにアクセスします。

2  または  を押して [れんらくさき] に移動します。  を押して選択します。

ディスプレイにアルファベット順でエントリが表示されます。

3  または  を押して必要な無線機のエアリアスまたは ID に移動します。ディスプレイの 1 行目に [ばんごう:] と表示されます。ディスプレイの 2 行目に、点滅するカーソルが表示されます。キーパッドを使用して、電話番号を入力します。



4  を押して選択します。選択したエントリが空の場合、ネガティブインジケータトーンが鳴り、ディスプレイに [つうわむこうなばんごう] と表示されます。

5  または  を押して [つうわ] に移動します。  を押して選択します。アクセスコードが連絡先リストで事前に設定されていない場合、ディスプレイの 1 行目に [アクセス コード:] と表示されます。ディスプレイの 2 行目に、点滅するカーソル

ルが表示されます。アクセスコードを入力し、 ボタンを押して先に進みます。成功すると、DTMF トーンが鳴ります。電話機ユーザーのダイアルトーンが聞こえます。ディスプレイの 1 行目に、無線機のエイリアスまたは ID と [RSSI] アイコンが表示されます。ディスプレイの 2 行目に [でんわつうわ] および [電話通話] アイコンが表示されます。失敗の場合、トーンが鳴り、ディスプレイに [でんわ NG] と表示されます。アクセスコード入力画面に戻ります。アクセスコードが [れんらくさき] リストで事前に設定されている場合、そのコールを開始する前の画面に戻ります。

- 6 話すときには **PTT** ボタンを押し、聞くときにはボタンを放します。送信中は [RSSI] アイコンが消えます。
- 7 電話通話中に追加の数字を入力する必要がある場合は、次のいずれか 1 つの手順を実行します。
 - キーボードのいずれかのキーを押し、追加の数字の入力を始めます。ディスプレイの 1 行目に [つかケタ:] と表示されます。ディスプレイの 2 行目に、点滅するカーソルが表示されます。残りの数字を入力し、 を押して、先に進みます。DTMF トーンが鳴り、前の画面に戻ります。

- **ワンタッチアクセス** ボタンを押します。DTMF トーンが鳴ります。**ワンタッチアクセス** ボタンのエントリが空の場合、ネガティブインジケータトーンが鳴ります。

- 8 通話を終了するには、 を押します。アクセスコードが連絡先リストで事前に設定されていない場合、ディスプレイの 1 行目に [ディアアクセスコード:] と表示されます。ディスプレイの 2 行目に、点滅するカーソルが表示されます。ディアアクセスコードを入力し、 を押して先に進みます。前の画面に戻ります。DTMF トーンが鳴り、ディスプレイに [でんわせつだん] と表示されます。成功の場合、トーンが鳴り、ディスプレイに [でんわしゅうりょう] と表示されます。電話通話画面に戻ります。失敗した場合、無線機は電話通話画面に戻ります。電話連絡先画面で **PTT** ボタンを押すと、トーンが鳴り、ディスプレイに [コール >OK] と表示されます。電話機ユーザーが通話を終了するとトーンが鳴り、ディスプレイに [でんわしゅうりょう] と表示されます。電話通話でリクエストされた追加の数字を入力している間に通話が終了した場合、その通話を開始する前の画面に戻ります。

**注記:**

通話発信者は、 を押して、一斉コールを終了できます。

一斉コールの受信

一斉コールを受信すると、以下の状態になります。

- トーンが鳴ります。
- 緑色の LED が点滅します。
- ディスプレイの右上隅に **[グループ コール]** アイコンが表示されます。
- テキスト行の 1 行目に発信者のエイリアス ID が表示されます。
- テキスト行の 2 行目に、設定の種類に応じて **[いっせい コール]**、**[サイトいっせい コール]**、または **[マルチサイト コール]** のいずれかが表示されます。
- 無線機のミュートが解除され、着信通話の音はスピーカから聞こえます。

通話が終了すると、無線機は一斉コールを受信する前の画面に戻ります。

チャンネルフリー指示機能が有効になっている場合、送信側無線機が **[PTT]** ボタンを放したときに、短い警告トーンが

鳴ります。これは、そのチャンネルが使用できるようになったことを示しています。一斉コールには応答できません。

**注記:**

通話を受信中に別のチャンネルに切り替えると、無線機は一斉コールの受信を停止します。一斉コールが終了するまでは、メニューナビゲーションや編集は続行できません。

電話通話

電話通話は、個別の無線機または無線機グループと電話機との間の通話です。

無線機の設定方法によって、以下の機能が利用できる場合とできない場合があります。

- デュアルトーン マルチ周波数 (DTMF) トーン
- ディアクセス コード
- 電話通話受信時の発信者のエイリアスまたは ID の表示
- 電話通話を受けるか受けないかを選択できる機能

電話通話機能は、システムで電話番号を割り当てて設定することによって有効にすることができます。無線機がどのようにプログラムされているかについては、システム管理者に確認してください。

電話通話の発信

下記の手順に従って、無線機で通話を発信します。

- 1 プログラムされた **[ワンタッチアクセス]** ボタンを押して、事前に定義されたエイリアスまたは ID に移動します。

ワンタッチアクセス ボタンのエントリが空の場合、ネガティブインジケータトーンが鳴ります。

アクセスコードが **[れんらくさき]** リストで事前に設定されていない場合、ディスプレイに **【アクセスコード:】** と表示されます。

- 2 アクセスコードを入力し、 を押して先に進みます。

アクセスコードまたはディアクセスコードは 10 文字以下にする必要があります。

- 3 電話に応答するには、**[PTT]** ボタンを押します。

- 4 相手の声を聞くには、**PTT** ボタンを放します。

- 5 通話中に追加の数字を入力する必要がある場合、

 を押して先に進みます。

通話中に必要な追加の数字を入力している間に通話が終了した場合、通話を開始する前の画面に戻ります。

DTMF トーンが鳴ります。前の画面に戻ります。

- 6 通話を終了するには、 を押します。

- 7 以下のいずれか 1 つの手順を実行します。

- ディアクセスコードが事前に設定されていない場合は、ディスプレイに **【ディアクセスコード:】** と表示されたらディアクセスコードを入力し、 を押して先に進みます。前の画面に戻ります。
- プログラムされた **[ワンタッチアクセス]** ボタンを押します。 **ワンタッチアクセス** ボタンのエントリが空の場合、ネガティブインジケータトーンが鳴ります。

DTMF トーンが鳴り、ディスプレイに **【でんわせつだん】** と表示されます。

通話が正常に終了した場合:

- トーンが鳴ります。



- ディスプレイに【コールしゅうりょう】と表示されます。

通話が正常に終了しなかった場合、無線機は通話画面に戻ります。最後の2つの手順を繰り返すか、電話機ユーザーが通話を終了するまで待ちます。

プログラム可能なボタンで電話通話を行う

下記の手順に従って、プログラム可能なボタンで通話を行います。

- 1 プログラムされた【Tel】ボタンを押します。通話エントリリストが表示されます。

- 2  または  を押して必要なエリアまたは ID に移動します。  を押して選択します。
アクセスコードが【れんらくさき】リストで事前に設定されていなかった場合、ディスプレイには【アクセ

スコード:】と表示されます。アクセスコードを入力し、 ボタンを押して先に進みます。

緑色の LED が点灯します。ディスプレイに **電話通話** アイコン、無線機のエリアまたは ID、通話ステータスが表示されます。

通話設定に成功した場合:

- DTMF トーンが鳴ります。
- 電話機ユーザーのキャッチホン トーンが鳴りません。
- ディスプレイに **電話通話** アイコン、無線機のエリアまたは ID、【でんわつうわ】、通話ステータスが表示されます。

通話設定に失敗した場合:

- トーンが鳴ります。
- ディスプレイに【でんわ NG】と表示されます。
- アクセスコード入力画面に戻ります。アクセスコードが【れんらくさき】リストで事前に設定されている場合、そのコールを開始する前の画面に戻ります。

3 話すには、**PTT** ボタンを押して応答します。相手の声を聞くには、**PTT** ボタンを放します。送信中は [RSSI] アイコンが消えます。

4 通話中に数字を入力する必要がある場合は、次の操作を実行します。以下のいずれか 1 つの手順を実行します。

- キーボードのいずれかのキーを押し、追加の数字の入力を始めます。ディスプレイに [ついかのすうじ:] と表示され、カーソルが点滅します。残りの数字を入力し、 を押して、先に進みます。DTMF トーンが鳴り、前の画面に戻ります。
 - **ワンタッチ アクセス** ボタンを押します。DTMF トーンが鳴ります。**ワンタッチ アクセス** ボタンのエントリが空の場合、ネガティブ インジケータ トーンが鳴ります。
-

5 通話を終了するには、 を押します。

ディアクセス コードが [れんらくさき] リストで事前に設定されていなかった場合、ディスプレイに [ディアクセスコード:] と表示されます。ディアクセス

コードを入力し、 ボタンを押して先に進みます。

DTMF トーンが鳴り、ディスプレイに [でんわせつだん] と表示されます。

通話終了設定に成功するとトーンが鳴り、ディスプレイに [でんわしゅうりょう] と表示されます。

通話終了設定に失敗すると、通話画面に戻ります。

通話連絡先画面で **PTT** ボタンを押すと、トーンが鳴り、ディスプレイに [コール >OK] と表示されます。

電話機ユーザーが通話を終了するとトーンが鳴り、ディスプレイに [でんわしゅうりょう] と表示されます。

電話通話でリクエストされた追加の数字を入力している間に通話が終了した場合、その通話を開始する前の画面に戻ります。

**注記:**

チャンネルアクセス中に  を押すと、コール試行が解除され、トーンが鳴ります。



コール中、ディアクセスコードが事前設定されている状態で **ワンタッチアクセス** ボタンを押すか、追加の数字の入力としてディアクセスコードを入力すると、コールの終了が試行されます。

チャンネルアクセス中およびコードのアクセス/アクセス解除中、または追加の数字の送信中、無線機は **オン/オフ** ボタン、**音量アップ/音量ダウン** **音量ノブ**、および **チャンネルアップ/ダウン** **チャンネルロッカー** のみに応答します。無効な入力を行うたびにトーンが鳴りません。



連絡先リストを使用した電話通話の発信

下記の手順に従って、連絡先リストを使用して無線機で通話を発信します。

- 1  を押してメニューにアクセスします。



- 2  または  を押して **【れんらくさき】** に移動します。  を押して選択します。

ディスプレイにアルファベット順でエントリが表示されます。

- 3  または  を押して必要なエリアまたは **ID** に移動します。  を押して選択します。

通話連絡先画面で **PTT** ボタンを押した場合:

- ネガティブインジケータトーンが鳴ります。
- ディスプレイに **【コール >OK】** と表示されます。選択したエントリが空の場合:
 - ネガティブインジケータトーンが鳴ります。
 - ディスプレイに **【つうわむこうなばんごう】** と表示されます。

- 4  または  を押して【つうわ】に移動します。  を押して選択します。
- アクセスコードが事前に設定されていない場合、ディスプレイに【アクセスコード:】と表示されます。

- 5 アクセスコードを入力し、  を押して先に進みます。
- アクセスコードまたはディアクセスコードは 10 文字以下にする必要があります。
- ディスプレイには、【よびだしちゆう】、無線機のエイリアスまたは ID、**プライベート通話** アイコンが表示されます。
- 通話に成功した場合:
- DTMF トーンが鳴ります。
 - 電話機ユーザーのキャッチホン トーンが鳴ります。
 - ディスプレイには、無線機のエイリアスまたは ID、**電話通話** アイコン、および【でんわつうわ】が表示されます。
- 通話に失敗した場合:
- トーンが鳴ります。

- ディスプレイに【でんわ NG】と表示されてから、【アクセスコード:】と表示されます。
- アクセスコードが連絡先リストで事前に設定されている場合、通話を開始する前の画面に戻ります。

- 6 電話に応答するには、**[PTT]** ボタンを押します。
[RSSI] アイコンが消えます。

- 7 相手の声を聞くには、**PTT** ボタンを放します。

- 8 通話中に追加の数字を入力する必要がある場合は、 を押して先に進みます。
- 通話中に必要な追加の数字を入力している間に通話が終了した場合、通話を開始する前の画面に戻ります。
- DTMF トーンが鳴ります。前の画面に戻ります。

- 9 通話を終了するには、 を押します。

- 10 ディアクセスコードが事前に設定されていない場合は、ディスプレイに【ディアクセスコード:】と表示

されたらディアクセス コードを入力し、 を押して先に進みます。

前の画面に戻ります。DTMF トーンが鳴り、ディスプレイに【でんわせつだん】と表示されます。

通話が正常に終了した場合:

- トーンが鳴ります。
- ディスプレイに【コールしゅうりょう】と表示されます。

通話が正常に終了しなかった場合、無線機は通話画面に戻ります。**ステップ 9**と**ステップ 10**を繰り返すか、電話機ユーザーが通話を終了するまで待ちます。通話連絡先画面でPTT ボタンを押すと、トーンが鳴り、ディスプレイに【コール >OK】と表示されます。

電話機ユーザーが通話を終了するとトーンが鳴り、ディスプレイに【でんわしゅうりょう】と表示されます。

電話通話でリクエストされた追加の数字を入力している間に通話が終了した場合、その通話を開始する前の画面に戻ります。



注記:

チャンネル アクセス中に  を押すと、コール試行が解除され、トーンが鳴ります。

コール中、ディアクセス コードが事前設定されている状態で**ワンタッチ アクセス** ボタンを押すか、追加の数字の入力としてディアクセス コードを入力すると、コールの終了が試行されます。



チャンネル アクセスおよびアクセス/ディアクセス コードまたは追加の数字の送信中、無線機は**オン/オフ** ボタン、**音量コントロール ノブ**、および**チャンネル ロッカー**にのみ反応します。無効な入力を行うたびにトーンが鳴ります。

エイリアス検索を使用した電話通話の発信



エイリアスや英数字検索を使用して、必要な無線機のエイリアスを取得することもできます。この機能は、**[れんらくさき]**のみに適用されます。下記の手順に従って、エイリアス検索を使用して無線機で通話を発信します。

1



 を押してメニューにアクセスします。

- 2  または  を押して [れんらくさき] に移動します。  を押して選択します。

ディスプレイにアルファベット順でエントリが表示されます。

- 3  または  を押して、必要な無線機のエイリアスまたは ID に移動します。

- 4  を押して選択します。選択したエントリが空の場合、ネガティブインジケータトーンが鳴り、ディスプレイに [つうわむこうなばんごう] と表示されます。

- 5  または  を押して [つうわ] に移動します。  を押して選択します。

アクセスコードが [れんらくさき] リストで事前に設定されていなかった場合、ディスプレイに [アクセスコード:] と表示され、カーソルが点滅します。アクセスコードを入力し、  ボタンを押して先に進みます。

正常に行われた場合:

- DTMF トーンが鳴ります。
- 電話機ユーザーのキャッチホントーンが鳴ります。
- ディスプレイに、無線機のエイリアスまたは ID、**RSSI** アイコン、[でんわつうわ]、および **電話通話** アイコンが表示されます。

正常に行われなかった場合:

- トーンが鳴ります。
- ディスプレイに [でんわ NG] と表示されます。
- アクセスコード入力画面に戻ります。アクセスコードが [れんらくさき] リストで事前に設定されている場合、そのコールを開始する前の画面に戻ります。

- 6 話すときには **PTT** ボタンを押し、聞くときにはボタンを放します。送信中は **[RSSI]** アイコンが消えます。

- 7 電話通話中に追加の数字を入力する必要がある場合は、次のいずれか 1 つの手順を実行します。
- キーボードのいずれかのキーを押し、追加の数字の入力を始めます。ディスプレイに [ついかのすうじ:] と表示され、カーソルが点滅します。追加

の数字を入力し、 を押して、先に進みます。
DTMF トーンが鳴ります。

- **ワンタッチ アクセス** ボタンを押します。DTMF トーンが鳴ります。**[ワンタッチ アクセス]** ボタンのエントリが空の場合、ネガティブ インジケータ トーンが鳴って無線機が前の画面に戻ります。

8 通話を終了するには、 を押します。

ディアクセス コードが [れんらくさき] リストで事前に設定されていなかった場合、ディスプレイに [ディアクセスコード:] と表示され、カーソルが点滅しま

す。ディアクセス コードを入力し、 を押して先に進みます。

前の画面に戻ります。DTMF トーンが鳴り、ディスプレイに [でんわせつだん] と表示されます。

正常に行われた場合:

- トーンが鳴ります。
- ディスプレイに [でんわしゅうりょう] と表示されます。
- 電話通話画面に戻ります。

正常に行われなかった場合:

- 電話通話画面に戻ります。
- 電話連絡先画面で **PTT** ボタンを押すと、トーンが鳴り、ディスプレイに [コール >OK] と表示されます。
- 電話機ユーザーが通話を終了するとトーンが鳴り、ディスプレイに [でんわしゅうりょう] と表示されます。
- 電話通話でリクエストされた追加の数字を入力している間に通話が終了した場合、その通話を開始する前の画面に戻ります。

**注記:**

チャンネルアクセス中に を押して、コール試行とトーン音ボタンを解除するか、エイリアス検索を終了します。エイリアス検索を終了するには、

ボタンまたは を押します。コール中、ディアクセスコードが事前設定されている状態で**ワンタッチアクセス** ボタンを押すか、追加の数字の入力としてディアクセスコードを入力すると、コールの終了が試行されます。チャンネルアクセスおよびアクセス/ディアクセスコードまたは追加の数字の送信中は、無線機は、オン/オフ ボタン、音量コントロールノブ、およびチャンネルロッカーにのみ反応します。無効な入力を行うたびにトーンが鳴ります。

ダイアルを使用した電話通話の発信

下記の手順に従って、ダイアルを使用して無線機で通話を発信します。

1 を押してメニューにアクセスします。

2 または を押して「れんらくさき」に移動します。 を押して選択します。

3 または を押して、「ダイアル」に移動します。 を押して選択します。

4 または を押して、「ばんごう」に移動します。 を押して選択します。ディスプレイに「ばんごう:」と表示され、カーソルが点滅します。

5 電話番号を入力し、 を押して先に進みます。アクセスコードが事前に設定されていない場合、ディスプレイに「アクセスコード:」と表示され、カーソルが点滅します。

6 アクセスコードを入力し、 を押して先に進みます。アクセスコードまたはディアクセスコードは 10 文字以下にする必要があります。

緑色の LED が点灯します。ディスプレイに **電話通話** アイコン、無線機のエイリアス、通話ステータスが表示されます。

通話に成功した場合:

- DTMF トーンが鳴ります。
- 電話機ユーザーのキャッチホン トーンが鳴ります。
- ディスプレイには、無線機のエイリアスおよび **電話通話** アイコンが表示されます。

通話に失敗した場合:

- トーンが鳴ります。
- ディスプレイに【でんわ NG】と表示されてから、【アクセスコード:】と表示されます。
- アクセス コードが連絡先リストで事前に設定されている場合、通話を開始する前の画面に戻ります。

7 通話を終了するには、 を押します。

8 以下のいずれか 1 つの手順を実行します。

- ディアクセス コードが事前に設定されていない場合は、ディスプレイに【ディアクセスコード:】と表示されたらディアクセス コードを入力し、 を押して先に進みます。前の画面に戻ります。

- プログラムされた **[ワンタッチ アクセス]** ボタンを押します。 **ワンタッチ アクセス** ボタンのエントリが空の場合、ネガティブ インジケータ トーンが鳴ります。

DTMF トーンが鳴り、ディスプレイに【でんわせつだん】と表示されます。

通話が正常に終了した場合:

- トーンが鳴ります。
- ディスプレイに【コールしゅうりょう】と表示されます。

通話が正常に終了しなかった場合、無線機は通話画面に戻ります。 **ステップ 7** を繰り返します (または電話機ユーザーが通話を終了するまで待ちます)。

**注記:**

通話連絡先画面で **PTT** ボタンを押すと、トーンが鳴り、ディスプレイに【コール OK】と表示されます。

電話機ユーザーが通話を終了するとトーンが鳴り、ディスプレイに【コールしゅうりょう】と表示されます。

通話でリクエストされた追加の数字を入力している間に通話が終了した場合、そのコールを開始する前の画面に戻ります。

チャンネルアクセス中に **5*** を押すと、コール試行が解除され、トーンが鳴ります。

コール中、ディアクセスコードが事前設定されている状態で**ワンタッチアクセス** ボタンを押すか、追加の数字の入力としてディアクセスコードを入力すると、コールの終了が試行されます。

チャンネルアクセスおよびアクセス/ディアクセスコードまたは追加の数字の送信中、無線機は**オン/オフ** ボタン、**音量コントロールノブ**、および**チャンネルロッカー**にのみ反応しません。無効な入力を行うたびにトーンが鳴りません。

デュアルトーン マルチ周波数

デュアルトーン マルチ周波数 (DTMF) 機能を使用すると、無線機システム内で電話機システムを操作できます。

すべての無線機トーンと警告を無効にすることで、DTMF トーンをオフにできます。詳細については、「[無線機トーン/アラートのオンとオフの切り替え ページ 204](#)」を参照してください。

DTMF 通話の開始

下記の手順に従って、無線機で DTMF 通話を開始します。

- 1 **PTT** ボタンを押し続けます。
- 2 以下のいずれか 1 つの手順を実行します。
 - 番号を入力して DTMF 通話を開始します。
 - ***->** を押して DTMF 通話を開始します。
 - **色#** を押して DTMF 通話を開始します。

一斉コールとして電話通話への応答

一斉コール通話を受信したときは、受信無線機はトークバックも応答もできません。また受信ユーザーは、一斉コールを終わらせることもできません。

一斉コール通話を受信した場合:

- ディスプレイの右上隅に **[電話]** アイコンが表示されます。
- ディスプレイには、設定の種類に応じて【いっせいコール】、【サイトいっせいコール】、または【マルチサイトコール】のいずれかと【でんわ】が表示されます。
- 緑色の **LED** が点滅します。
- 無線機のミュートが解除され、着信通話の音はスピーカから聞こえます。

グループコールとして電話通話への応答

下記の手順に従って、無線機でグループコール通話に応答します。

グループコール通話を受信した場合:

- ディスプレイに、**電話通話** アイコンと【でんわつうわ】が表示されます。
- 緑色の **LED** が点滅します。

- 無線機のミュートが解除され、着信通話の音はスピーカから聞こえます。

1 電話に応答するには、**[PTT]** ボタンを押します。

2 相手の声を聞くには、**PTT** ボタンを放します。

3 通話を終了するには、 を押します。



注記:

お使いの無線機では、電話通話をグループコールとして終了することはできません。電話機ユーザーが通話を終了する必要があります。受信ユーザーは、通話中にトークバックのみを行うことができます。

ディスプレイに【でんわせつだん】と表示されます。通話が正常に終了した場合:

- トーンが鳴ります。
- ディスプレイに【コールしゅうりょう】と表示されます。

通話が正常に終了しなかった場合、無線機は通話画面に戻ります。**ステップ3**を繰り返します(または電話機ユーザーが通話を終了するまで待ちます)。

個別コールとして電話通話への応答

下記の手順に従って、無線機で個別コール通話に応答します。

個別コール通話を受信した場合:

- ディスプレイに、**電話通話** アイコンと【でんわつうわ】が表示されます。
- 緑色の LED が点滅します。
- 無線機のミュートが解除され、着信通話の音はスピーカから聞こえます。

1 電話に応答するには、**[PTT]** ボタンを押します。

2 相手の声を聞くには、**PTT** ボタンを放します。

3 通話を終了するには、 を押します。



注記:

お使いの無線機では、電話通話をグループコールとして終了することはできません。電話機ユーザーが通話を終了する必要があります。受信ユーザーは、通話中にトークバックのみを行うことができます。

ディスプレイに【でんわせつだん】と表示されます。

通話が正常に終了した場合:

- トーンが鳴ります。
- ディスプレイに【コールしゅうりょう】と表示されます。

通話が正常に終了しなかった場合、無線機は通話画面に戻ります。**ステップ 3**を繰り返します(または電話機ユーザーが通話を終了するまで待ちます)。

割り込み通話

割り込み通話では、無線機が実行中の音声送信を停止し、優先送信を開始できます。

割り込み通話機能により、システムは、トランキングチャネルを利用できない場合に、進行中の通話に割り込みます。

緊急通話や一斉コールのような優先度の高い通話は、無線機が送信中でも割り込みが許可されているため、より優先度の高い通話に対応することができます。他の無線周波数(RF)チャネルが利用できない場合、緊急通話は一斉コールにも割り込みます。

音声割り込み

音声割り込み機能を使うと、進行中の音声送信を停止することができます。

この機能では、割り込みを行う無線機が音声割り込み可能に設定され、送信を行う無線機が音声通話割り込み可能に設定されている場合に、逆チャンネルシグナリングを使用して進行中の音声送信を停止します。その後、割り込みを行う無線機は、停止された通話の参加者へ音声送信を行うことができます。

音声割り込み機能によって、通話中の対象者に対して新たに送信を行う成功率が大幅に上がります。

ユーザーが音声割り込み機能にアクセスできるのは、この機能が無線機で設定されている場合のみです。詳細については、ディーラーまたはシステム管理者にご確認ください。

音声割り込みの有効化

下記の手順に従って、無線機で音声割り込みを開始します。

この機能を使用するには、無線機をプログラムする必要があります。詳細については、ディーラーまたはシステム管理者にご確認ください。

- 1 通話中に送信に割り込むには、**[PTT]** ボタンを押します。

割り込みされた無線機では、ディスプレイに「つうわりこみ」と表示されます。**[PTT]** ボタンが放されるまで、ネガティブインジケータトーンが鳴り続けます。

-
- 2 確認応答を待ちます。

正常に行われた場合:

- ポジティブインジケータトーンが鳴ります。

正常に行われなかった場合:

- ネガティブインジケータトーンが鳴ります。

-
- 3 以下のいずれか 1 つの手順を実行します。

- 通話許可トーンが完了するまで待機し、マイクに向かってはっきりと話します (有効な場合)。
- **PTT** サイドトーンが完了するまで待機し、マイクに向かってはっきりと話してください (有効な場合)。

高度な機能

この章では、無線機で使用できる機能の操作について説明します。

ディーラーやシステム管理者が、特定のニーズのために無線機をカスタマイズしている可能性もあります。詳細については、ディーラーまたはシステム管理者にご確認ください。

通話キュー

通話の処理に利用できるリソースがない場合、通話キューによって、次に利用可能なリソースのシステム キューに通話リクエストを加えることができます。

PTT ボタンを押すと、通話キュー トーンが鳴り、無線機の画面に『待機中の通話』と表示されて、無線機が通話キュー状態に入ったことを示します。通話キュー トーンが鳴ったら **[PTT]** ボタンを放してかまいません。

通話設定が成功すると、以下の状態になります。

- 緑色の **LED** が点滅します。
- 有効にした場合、通話許可トーンが鳴ります。
- ディスプレイに通話タイプのアイコン、ID、またはエリアが表示されます。

- 無線機のユーザーは、**4** 秒以内に **[PTT]** ボタンを押して音声通信を開始します。

通話設定に失敗すると、以下の状態になります。

- 有効にした場合、拒否トーン音が鳴ります。
- ディスプレイに失敗通知画面が瞬時的に表示されます。
- 通話が終了し、無線機は通話設定を終了します。

優先通話

優先通話を使用すると、システムは、すべてのチャンネルがビジー状態のとき、優先通話ではない通話のいずれかを阻止し、高優先の通話を開始することができます。

すべてのチャンネルが高優先の通話で占有されている場合は通話を阻止せず、要求されている高優先度の通話を通話キューに入れます。システムが、要求されている高優先度の通話を通話キューに入れられない場合は失敗の通知を発します。

優先通話のデフォルト設定は、事前に設定されています。プログラム可能ボタンを押して、通常の優先度と高優先を切り替えます。以下の機能を使用する場合、通話の優先度は自動的に事前設定されていたレベルに戻ります。

- すべての音声通話
- **DMR III** テキスト メッセージ/テキスト メッセージ

- ワーク チケット
- リモート モニタ

**注記:**

無線機がどのようにプログラムされているかについては、ディーラーまたはシステム管理者に確認してください。

優先通話の種類は以下のとおりです。

高優先

無線機には、[つぎのつうわ: [高優先]と表示されま
す。

無線機のディスプレイ上部に **通話優先度: 高** アイコン
が表示されます。

次の通話: 通常優先の音声ガイドが流れます。

通常優先

無線機には、[つぎのつうわ: [通常優先]と表示されま
す。

通話優先度: 高 アイコンが消えます。

次の通話: 通常優先の音声ガイドが流れます。

グループ スキャン

この機能を使用すると、無線機では、受信グループ リストに定義されているグループのコールをモニタし、これに参加できます。

スキャンが有効な場合、ステータス バーにスキャン アイコンが表示され、LED が黄色に点滅します。受信グループ リストのメンバーに対しては、無線機のミュートは解除されます。

スキャンが無効になっていると、無線機は受信グループ リストのメンバーからの通話を、一斉コールおよび選択されているグループの場合を除いて受信できません。

**注記:**



グループ スキャンは、CPS を使用して設定できます。無線機がどのようにプログラムされているかについては、システム管理者に確認してください。

グループ スキャンのオンとオフの切り替え







下記の手順に従って、無線機でグループ スキャンのオンとオフを切り替えます。

1

 を押してメニューにアクセスします。

2  または  を押して【スキャン】に移動します。 を押して選択します。

3 以下のいずれか 1 つの手順を実行します。

-  または  を押して【オン】に移動します。 を押して選択します。
-  または  を押して【オフ】に移動します。 を押して選択します。

スキャンが有効になっている場合:

- ディスプレイに【スキャン オン】と【スキャン】アイコンが表示されます。
- 黄色の LED が点滅します。
- ポジティブ インジケータ トーンが鳴ります。

スキャンが無効になっている場合:

- ディスプレイに【スキャン オフ】と表示されます。
- 【スキャン】アイコンが消えます。
- LED がオフになります。
- ネガティブ インジケータ トーンが鳴ります。

受信グループ リスト

受信グループ リストは、グループ スキャン リストのメンバーの作成と割り当てができる機能です。

このリストは無線機がプログラムされる場合に作成され、このリストによって、スキャンできるグループが決まります。お使いの無線機は、このリストに含まれる 16 名まで対応できます。

無線機がスキャン リストを編集するようにプログラムされていると、次のことが可能です。

- グループの追加/削除。
- グループの優先度の追加、削除、編集。「[グループの優先度の設定 ページ 101](#)」を参照してください。
- 加入グループの追加、削除、編集。「[加入グループの追加 ページ 102](#)」および「[加入グループの削除 ページ 103](#)」を参照してください。
- 既存のスキャン リストの新しいスキャン リストへの置き換え。



重要:

リストにメンバーを追加するには、最初に無線機でグループを設定する必要があります。

**注記:**

受信グループ リストは、システム管理者がプログラムします。詳細については、ディーラーまたはシステム管理者にご確認ください。

優先度モニタ

優先度モニタ機能を使用すると、無線機は、グループ コール中でも優先度の高いグループからのコールを受信すると、自動的にコールを切り替えます。

無線機は、優先度の低いグループのコールを止めて、優先度の高いグループのコールに切り替えます。

**注記:**

この機能は、グループ スキャン機能が有効な場合のみアクセスできます。

優先度モニタ機能は、受信グループ リストに含まれるメンバーのみに適用されます。優先度グループには、優先度 **1 (P1)** と優先度 **2 (P2)** の 2 つがあります。P1 が P2 よりも優先します。Capacity Max システムでは、無線機は次の優先順序に従って通話を受信します。

- 1 P1 グループの緊急コール
- 2 P2 グループの緊急コール
- 3 受信グループ リスト内の非優先グループの緊急コール

- 4 一斉コール
- 5 P1 グループ コール
- 6 P2 グループ コール
- 7 受信グループ リスト内の非優先グループ

スキャン リスト内のグループの優先度を追加、削除、編集する方法の詳細については、「[グループの優先度の設定 ページ 101](#)」を参照してください。

**注記:**



この機能は、システム管理者がプログラムします。詳細については、ディーラーまたはシステム管理者にご確認ください。



グループの優先度の設定

グループ スキャン メニューで、グループの優先度を表示または編集できます。



- 1 を押してメニューにアクセスします。



- 2 または を押して [スキャン] に移動します。 を押して選択します。



3  または  を押して [リストへんしゅう] に移動します。  を押して選択します。

4  または  を押して必要なグループに移動します。  を押して選択します。

現在の優先度は、グループの隣の **【ゆうせん 1】** または **【ゆうせん 2】** アイコンで示されます。

5  または  を押して [ゆうせんど] に移動します。  を押して選択します。

6  または  を押して必要な優先度に移動します。  を押して選択します。

別のグループが優先度 1 または優先度 2 に割り当てられている場合、現在の優先度を上書きするように選択できます。ディスプレイに [うわがき?] が表示されたら、 または  を押して次のオプションに移動します。

- 前の手順に戻るには、[いいえ] に移動します。

- 上書きするには、[はい] に移動します。

ディスプレイにポジティブ ミニ通知が表示された後、前の画面に戻ります。優先度アイコンがグループの隣に表示されます。

複数グループの加入

Capacity Max システムでは、無線機に 1 サイトで最大 7 つのグループを設定できます。

受信グループリスト内の 16 グループのうち、最大 7 つのグループを加入グループとして割り当てできます。選択したグループおよび優先度グループは、自動的に加入として処理されます。







注記:



この機能は、システム管理者がプログラムします。詳細については、ディーラーまたはシステム管理者にご確認ください。



加入グループの追加

下記の手順に従って、加入グループを追加します。



- 1  を押してメニューにアクセスします。

2  または  を押して【スキャン】に移動します。  を押して選択します。



3  または  を押して【リストへんしゅう】に移動します。  を押して選択します。



4  または  を押して必要なグループ ID またはエイリアスに移動します。  を押して選択します。

加入ステータスが【リストへんしゅう】に表示されます。ディスプレイには、選択したグループ ID またはエイリアスの隣に  が表示されます。

5  または  を押して【加入の編集】に移動します。  を押して選択します。

6 以下のいずれか 1 つの手順を実行します。

-  または  を押して【オン】に移動します。  を押して選択します。

-  または  を押して【オフ】に移動します。  を押して選択します。

【オン】を選択すると、グループ ID またはエイリアスの隣に  が表示されます。

加入が正常に行われると、ディスプレイには、選択したグループ ID またはエイリアスの隣に  が表示されます。

加入が正常に行われなかった場合、グループ ID またはエイリアスの隣には、そのまま  が表示されます。



注記:



スキャン リストで、加入グループを最大限の 7 つ選択すると、無線機に【リストがまんぱい】と表示されます。新しい加入グループを選択するには、加入された既存のグループを削除して、新たに追加するグループのために場所を空けます。詳細については、「[加入グループの削除 ページ 103](#)」を参照してください。



加入グループの削除



加入リストが満杯のときに新しい加入グループを選択するには、加入された既存のグループを削除して、新たに追加



するグループのために場所を空けます。下記の手順に従って、加入グループを削除します。



- 1  を押してメニューにアクセスします。

- 2  または  を押して【スキャン】に移動します。  を押して選択します。

- 3  または  を押して【リストへんしゅう】に移動します。  を押して選択します。

- 4  または  を押して必要なグループ ID またはエイリアスに移動します。  を押して選択します。
加入ステータスが【リストへんしゅう】に表示されます。ディスプレイには、選択したグループ ID またはエイリアスの隣に ■ が表示されます。

- 5  または  を押して【加入の編集】に移動します。  を押して選択します。

- 6  または  を押して【オフ】に移動します。
 を押して選択します。
【オフ】を選択すると、グループ ID またはエイリアスの隣の ■ が消えます。

トークバック

トークバック機能を使用すると、スキャンの実行中に送信に応答できません。

選択可能なグループ スキャン リストで通話をスキャンしていて、その通話中に **[PTT]** ボタンを押した場合、無線機の動作は、無線機のプログラミングの間にトークバックが有効だったか無効だったかに応じて決まります。詳細については、ディーラーまたはシステム管理者にご確認ください。

トークバック無効

無線機がスキャンされた通話を終了し、現在選択されているチャンネル位置の連絡先名に基づいて送信を行います。現在選択されている連絡先のコールハングタイムの期限が切れた後、無線機はホームチャンネルに戻り、スキャンハングタイムタイマーを開始します。スキャンハングタイムタイマーの期限が切れた後、無線機はグループスキャンを再開します。

トークバック有効

スキャンされた通話のグループ ハング タイム中に **PTT** ボタンを押すと、無線機はスキャン グループへの送信を試みます。



注記:

現在選択されているゾーン内のチャンネル位置に割り当てられていないグループに対する通話をスキャンしていて、通話が終了した場合、適切なゾーンに切り替えてから、グループのチャンネル位置を選択し、そのグループにトーク バックします。

Bluetooth

Bluetooth 接続を介して、お使いの無線機と Bluetooth 対応デバイス (アクセサリ) を連携できます。お使いの無線機では、**Motorola Solutions** 製および **COTS** (市販既製品) の両方の Bluetooth 対応デバイスをサポートしています。

Bluetooth は、直線距離 **10 メートル (32 フィート)** の範囲内で動作します。これは、無線機と Bluetooth 対応デバイスとの間に障害物が何もない場合の距離です。信頼性を高めるために、**Motorola Solutions** では無線機とアクセサリを離さないことをお勧めします。

受信不良地域では、音声とトーン両方が「不明瞭」または「割れて」聞こえるようになります。この問題を解決するには、無線機と Bluetooth 対応デバイスを規定の **10 メートル**

以内に近づけて、明瞭な音声受信を再確立してください。無線機の Bluetooth 機能の最大出力は、**10 メートル範囲で 2.5mW (4dBm)** です。

無線機は、異なる種類の Bluetooth 対応デバイスとの Bluetooth 接続を同時に **3** 接続までサポートできます。たとえば、ヘッドセット、スキャナ、および **PTT** 専用デバイス (POD) は同時に接続できます。同じ種類の複数の Bluetooth 対応デバイスには、同時に接続できません。

Bluetooth 対応デバイスの全機能の詳細については、個々の Bluetooth 対応デバイスのユーザー マニュアルを参照してください。



注記:

CPS 経由で無効にされている場合、すべての Bluetooth 関連機能が無効になり、Bluetooth 機器データベースは消去されます。



ブルートゥースのオン/オフの切り替え



下記の手順に従って、Bluetooth のオンとオフを切り替えます。

1







を押してメニューにアクセスします。





2  または  を押して [Bluetooth] に移動します。  を押して選択します。

3  または  を押して [ステータス] に移動します。  を押して選択します。

ディスプレイに [オン] と [オフ] が表示されます。
現在のステータスは  で示されます。

4 以下のいずれか 1 つの手順を実行します。

-  または  を押して [オン] に移動します。  を押して選択します。ディスプレイで  が [オン] の隣に表示されます。



-  または  を押して [オフ] に移動します。  を押して選択します。ディスプレイで  が [オフ] の隣に表示されます。



Bluetooth デバイスへの接続

下記の手順に従って、Bluetooth デバイスに接続します。



Bluetooth 対応デバイスの電源を入れ、ペアリングモードにします。



1  を押してメニューにアクセスします。



2  または  を押して [Bluetooth] に移動します。  を押して選択します。



3  または  を押して [デバイス] に移動します。  を押して選択します。

4 以下のいずれか 1 つの手順を実行します。

-  または  を押して必要なデバイスに移動します。  を押して選択します。

-  または  を押して [デバイス サーチ] に移動し、使用できるデバイスを見つけます。

-  または  を押して必要なデバイスに移動します。  を押して選択します。

- 5  または  を押して [せつぞく] に移動します。  を押して選択します。

ペアリングを完成させるには、Bluetooth 対応デバイスでさらに手順が必要になることがあります。

Bluetooth 対応デバイスのユーザー マニュアルを参照してください。

ディスプレイに [〈デバイス〉 せつぞくちゅう] と表示されます。

確認応答を待ちます。
正常に行われた場合:

- ポジティブ インジケータ トーンが鳴ります。
- ディスプレイに [〈デバイス〉 せつぞくずみ] と [Bluetooth 接続済み] アイコンが表示されます。
- 接続されたデバイスに加えて、ディスプレイに  が表示されます。

正常に行われなかった場合:

- ネガティブ インジケータ トーンが鳴ります。
- ディスプレイに [せつぞくしっぱい] と表示されます。



注記:

ピンコードが必要な場合は、「パスワードを使用した無線機へのアクセス ページ 186」を参照してください。

検出可能モードでの Bluetooth デバイスへの接続

下記の手順に従って、検出可能モードで Bluetooth デバイスに接続します。

Bluetooth 対応デバイスの電源を入れ、ペアリング モードにします。

- 1  を押してメニューにアクセスします。
- 2  または  を押して [Bluetooth] に移動します。  を押して選択します。
- 3  または  を押して [Find Me] に移動します。  を押して選択します。 無線機が、プログラムされた期間に他の Bluetooth 対応デバイスで検

出可能になります。これを検出可能モードと呼びます。

確認応答を待ちます。
正常に行われた場合:





- ポジティブ インジケータ トーンが鳴ります。
- ディスプレイに【<デバイス> せつぞくずみ】と【Bluetooth 接続済み】アイコンが表示されます。
- 接続されたデバイスに加えて、ディスプレイに ✓ が表示されます。



正常に行われなかった場合:



- ネガティブ インジケータ トーンが鳴ります。
- ディスプレイに【せつぞくしっぱい】と表示されます。



Bluetooth デバイスからの切断

下記の手順に従って、Bluetooth デバイスから切断します。

- 1  を押してメニューにアクセスします。
- 2  または  を押して【Bluetooth】に移動します。  を押して選択します。

- 3  または  を押して【デバイス】に移動します。  を押して選択します。

- 4  または  を押して必要なデバイスに移動します。  を押して選択します。

- 5  または  を押して【せつだん】に移動します。  を押して選択します。

ディスプレイに【<デバイス> からせつだんちゆう】と表示されます。



注記:

切断するには、Bluetooth 対応デバイスでさらに手順が必要になることがあります。

Bluetooth 対応デバイスの各ユーザー マニュアルを参照してください。

確認応答を待ちます。

- トーンが鳴ります。
- ディスプレイに【<デバイス> せつだんずみ】と表示され、【Bluetooth 接続済み】アイコンが消えます。

- 接続されていたデバイスの横から ✓ が消えます。

内部無線機スピーカと Bluetooth デバイスの間のオーディオルートの切り替え

下記の手順に従って、内部無線機スピーカと外部 Bluetooth デバイスの間でオーディオルートを切り替えます。

プログラムされた **[Bluetooth オーディオ切り替え]** ボタンを押します。



ディスプレイに次のいずれかの結果が表示されます。



- トーンが鳴ります。ディスプレイに【おんせい>むせんき】と表示されます。
- トーンが鳴ります。ディスプレイに【おんせい>Bluetooth】と表示されます。



デバイスの詳細の表示



下記の手順に従って、無線機でデバイスの詳細を表示します。

- 1  を押してメニューにアクセスします。

- 2  または  を押して [Bluetooth] に移動します。  を押して選択します。

- 3  または  を押して [デバイス] に移動します。  を押して選択します。



- 4  または  を押して必要なデバイスに移動します。  を押して選択します。



- 5  または  を押して [しょうさい] に移動します。  を押して選択します。



デバイス名の削除



Bluetooth 対応デバイスのリストから切断済みデバイスを削除できます。



- 1  を押してメニューにアクセスします。



2  または  を押して [Bluetooth] に移動します。  を押して選択します。



3  または  を押して [デバイス] に移動します。  を押して選択します。



4  または  を押して必要なデバイスに移動します。  を押して選択します。

5  または  を押して [さくじょ] に移動します。  を押して選択します。 ディスプレイに [デバイスさくじょずみ] と表示されます。

2  または  を押して [Bluetooth] に移動します。  を押して選択します。

3  または  を押して [BT マイクゲイン] に移動します。  を押して選択します。

4  または  を押して [BT マイクゲイン] タイプおよび現在の値に移動します。  を押して選択します。 ここで値を編集できます。

5  または  を押して値を増減します。  を押して選択します。

Bluetooth マイクゲイン

この機能により、ユーザーは接続された Bluetooth 対応デバイスのマイクゲイン値を調整できます。

1  を押してメニューにアクセスします。

屋内位置











注記:

屋内位置機能は、最新のソフトウェアおよびハードウェアを搭載したモデルにのみ適用されます。詳細については、ディーラーまたはシステム管理者にご確認ください。

屋内位置機能を使用して、無線機ユーザーの位置を追跡できます。屋内位置が有効になっていると、無線機は限定的に検出可能なモードになります。無線機を探して位置を特定するために、専用ビーコンが使用されます。

屋内位置のオンとオフ

屋内位置をオンまたはオフにするには、次の操作のいずれかを実行します。

- メニューからこの機能にアクセスします。
 - a.  を押してメニューにアクセスします を押します。
 - b.  または  を押して [Bluetooth] に移動し、 を押して選択します。
 - c.  または  を押して [屋内] に移動し、 を押して選択します。
 - d.  を押して [屋内] をオンにします。

ディスプレイに [屋内オン] と表示されます。ポジティブ インジケータ トーンが鳴ります。下記のいずれかの状態になります。

- 成功すると、[屋内位置利用可能] アイコンが [ホーム] 画面に表示されます。
- 失敗すると、ディスプレイに [屋内オン失敗] と表示されます。ネガティブ インジケータ トーンが鳴ります。

- e.  を押して屋内をオフにします。

ディスプレイに [屋内オフ] と表示されます。ポジティブ インジケータ トーンが鳴ります。下記のいずれかの状態になります。

- 成功すると、[屋内位置利用可能] アイコンが [ホーム] 画面から消えます。
- 失敗すると、ディスプレイに [屋内オフ失敗] と表示されます。ネガティブ インジケータ トーンが鳴ります。

- プログラムされたボタンを使用してこの機能にアクセスします。

- a. プログラムされた [屋内] ボタンを長押しして屋内をオンにします。

ディスプレイに [屋内オン] と表示されます。ポジティブ インジケータ トーンが鳴ります。下記のいずれかの状態になります。

- 成功すると、[屋内位置利用可能]アイコンが[ホーム]画面に表示されます。
 - 失敗すると、ディスプレイに[屋内オン失敗]と表示されます。失敗すると、ネガティブインジケータトーンが鳴ります。
- b. プログラムされた **[屋内]** ボタンを押して屋内配置をオフにします。



ディスプレイに[屋内オフ]と表示されます。ポジティブインジケータトーンが鳴ります。下記のいずれかの状態になります。



- 成功すると、[屋内位置利用可能]アイコンが[ホーム]画面から消えます。
- 失敗すると、ディスプレイに[屋内オフ失敗]と表示されます。失敗すると、ネガティブインジケータトーンが鳴ります。



屋内位置ビーコン情報へのアクセス

下記の手順に従って、屋内位置ビーコン情報にアクセスします。

-  を押してメニューにアクセスします を押します。

-  または  を押して [Bluetooth] に移動し、 を押して選択します。

-  または  を押して [屋内] に移動し、 を押して選択します。

-  または  を押して [ビーコン] に移動して、 を押して選択します。

ディスプレイにビーコン情報が表示されます。

マルチサイト コントロール

この機能は、現在の無線機チャネルが **Capacity Max** システムに対して設定されている場合に適用されます。

手動サイト検索の開始

受信した信号強度が弱い場合、より信号状態の良いサイトを探すために、下記の手順に従って手動サイト検索を開始します。

無線機が新しいサイトを見つけると:

- ポジティブ インジケータ トーンが鳴ります。

無線機が新しいサイトを検索できない場合:

- ネガティブ インジケータ トーンが鳴ります。

サイト ロック オン/オフ

オンに切り替えた場合、無線機は現在のサイトのみを検索します。オフに切り替えた場合、無線機は現在のサイトに加え、他のサイトも検索します。

プログラムされた **[サイト ロック]** ボタンを押します。

[サイト ロック] 機能をオンに切り替えると、

- ポジティブ インジケータ トーンが聞こえて、無線機が現在のサイトにロックされていることを示しています。
- ディスプレイに『サイト ロック済み』と表示されます。



[サイト ロック] 機能をオフに切り替えると、



- ネガティブ インジケータ トーンが聞こえます。無線機のロックが解除されていることを示しています。
- ディスプレイに『サイト ロックかいじょ』と表示されます。



隣接サイトのリストへのアクセス

この機能では、現在のホーム サイトに隣接するサイトのリストをチェックできます。下記の手順に従って、隣接サイトのリストにアクセスします。

- 1  を押してメニューにアクセスします。

- 2  または  を押して【せってい】に移動します。  を押して選択します。

- 3  または  を押して【きき じょうほう】に移動します。  を押して選択します。

- 4  または  を押して、【隣接サイト】に移動します。  を押して選択します。

ホーム チャンネル リマインダ

これは、無線機が一定期間ホーム チャンネルにセットされていない場合に通知を出す機能です。

この機能を有効にしている場合は、無線機が一定期間ホーム チャンネルにセットされていないと、以下の動作が定期的に繰り返されます。

- ホーム チャンネル リマインダ トーンが鳴り、音声ガイドが聞こえます。
- ディスプレイの 1 行目に【ノン】と表示されます。
- 2 行目に【ホーム チャンネル】と表示されます。

ホーム チャンネル リマインダのミュート

ホーム チャンネル リマインダが鳴った場合に、リマインダを一時的にミュートできます。

ホーム チャンネル リマインダのミュート プログラム可能ボタンを押します。



ディスプレイの 1 行目に【HCR】、2 行目に【サイレンス】が表示されます。



新しいホーム チャンネルの設定



ホーム チャンネル リマインダが通知された場合は、新しいホーム チャンネルをセットできます。



- 1 以下のいずれか 1 つの手順を実行します。

- **ホームチャンネルのリセット** プログラム可能ボタンを押して、現在のチャンネルをホームチャンネルとしてセットします。以下の手順をスキップします。
ディスプレイの1行目にチャンネルエイリアス、2行目に【しん ホーム Ch】が表示されます。
-  を押してメニューにアクセスします。

2  または  を押して【せってい】に移動します。
 を押して選択します。

3  または  を押して【きのうせってい】に移動します。
 を押して選択します。

4  または  を押して【ホームチャンネル】に移動します。
 を押して選択します。

5  または  を押して、目的の新しいホームチャンネルのエイリアスに移動します。
 を押して選択します。

ディスプレイには、選択したチャンネルエイリアスの横に✓が表示されます。

【リモート モニタ】

この機能を使用して、特定の無線機のエイリアスまたはIDを持つターゲットの無線機のマイクをオンにします。この機能を使用することで、ターゲット無線機の周りのあらゆる音声アクティビティをリモートでモニタできます。



この機能を使用するには、お使いの無線機とターゲット無線機の両方をプログラムする必要があります。

開始されると、ターゲットの無線機で緑色のLEDが1回点滅します。この機能は、プログラムされた期間、または相手の無線機でユーザーが何らかの操作を実行したとき、自動的に停止します。

リモート モニタの開始

下記の手順に従って、無線機でリモート モニタを開始します。

1 プログラムされた **[リモート モニタ]** ボタンを押します。

2  または  を押して必要なエリアまたは ID に移動します。  を押して選択します。ディスプレイに経過に関するミニ通知が表示され、要求が処理中であることが示されます。緑色の LED が点灯します。

3 確認応答を待ちます。

正常に行われた場合:

- ポジティブ インジケータ トーンが鳴ります。
- ディスプレイにポジティブ ミニ通知が表示されます。
- プログラムされた長さの間、モニタ対象の無線機から音声の再生が開始され、ディスプレイに「きようせいモニタ」と表示されます。タイマーの期

限が切れると、警告トーンが鳴り、LED が消灯します。



正常に行われなかった場合:



- ネガティブ インジケータ トーンが鳴ります。
 - ディスプレイにネガティブ ミニ通知が表示されます。
-



連絡先リストを使用したリモート モニタの開始

下記の手順に従って、連絡先リストを使用して無線機でリモート モニタを開始します。

1  を押してメニューにアクセスします。

2  または  を押して「れんらくさき」に移動します。  を押して選択します。

3  または  を押して必要なエリアまたは ID に移動します。  を押して選択します。

- 4  または  を押して [リモート モニタ] に移動します。  を押して選択します。
- ディスプレイに経過に関するミニ通知が表示され、要求が処理中であることが示されます。緑色の LED が点灯します。

5 確認応答を待ちます。

正常に行われた場合:











- ポジティブ インジケータ トーンが鳴ります。
- ディスプレイにポジティブ ミニ通知が表示されます。
- プログラムされた長さの間、モニタ対象の無線機から音声の再生が開始され、ディスプレイに [きょうせいモニタ] と表示されます。タイマーの期限が切れると、警告トーンが鳴り、LED が消灯します。

正常に行われなかった場合:



- ネガティブ インジケータ トーンが鳴ります。
- ディスプレイにネガティブ ミニ通知が表示されます。

ダイアルを使用したりリモート モニタの開始

下記の手順に従って、ダイアルを使用して無線機でリモート モニタを開始します。

- 1  を押してメニューにアクセスします。
- 2  または  を押して [れんらくさき] に移動します。  を押して選択します。
- 3  または  を押して [ダイアル] に移動します。  を押して選択します。
- 4  または  を押して [むせんきばんごう] に移動します。  を押して選択します。
- 5 以下のいずれか 1 つの手順を実行します。
 - 無線機のエアリアスまたは ID を入力し、  を押して処理を続行します。

- 以前にダイアルした ID を編集し、 を押して処理を続行します。

- 6  または  を押して [リモート モニタ] に移動します。  を押して選択します。

ディスプレイに経過に関するミニ通知が表示され、要求が処理中であることが示されます。緑色の LED が点灯します。

- 7 確認応答を待ちます。

正常に行われた場合:

- ポジティブ インジケータ トーンが鳴ります。
- ディスプレイにポジティブ ミニ通知が表示されます。
- プログラムされた長さの間、モニタ対象の無線機から音声の再生が開始され、ディスプレイに [きょうせいモニタ] と表示されます。タイマーの期限が切れると、警告トーンが鳴り、LED が消灯します。

正常に行われなかった場合:

- ネガティブ インジケータ トーンが鳴ります。

- ディスプレイにネガティブ ミニ通知が表示されます。

連絡先設定

連絡先は、無線機でアドレス帳として機能します。各エント리는、通話を開始するとき使用するエイリアスまたは ID に対応します。エント리는アルファベット順にソートされます。

各エント리는、コンテキストに応じて、次のような別々の通話タイプに関連づけられています。グループ コール、個別通話、ブロードキャスト コール、サイト一斉コール、マルチサイト一斉コール、PC コール、ディスパッチ コール。

PC コールとディスパッチ コールはデータ関連です。これらはアプリケーションで使用する場合にのみ利用できません。詳細については、データ アプリケーションのマニュアルを参照してください。

その他、[れんらくさき] メニューでは、各エント리를 1 つのプログラミング可能な数値キーに、複数のエント리를 キーパッドマイクに割り当てることができます。1 つのエント리가 1 つの数値キーに割り当てられている場合は、そのエントリに対してクイックダイアルを実行できます。

**注記:**

各エントリに割り当てられる数値キーの前にチェックマークが表示されます。チェックマークが【なし】の前にある場合、その数値キーはエントリに割り当てられていません。

連絡先の各エントリには、以下の情報が表示されます。

- [通話タイプ]
- 通話エイリアス
- [通話 ID]



**注記:**

あるチャンネルで秘話モード機能が有効であれば、そのチャンネルで、秘話対応のグループコール、個別コール、一斉コール、および通話を発信することができます。お使いの無線機と同一のプライバシーキー、または同じキー値とキー ID を有する相手先無線機のみが、送信を復号できます。

プログラム可能な数値キーへのエントリの割り当て



下記の手順に従って、無線機でプログラム可能な数値キーにエントリを割り当てます。

- 1 を押してメニューにアクセスします。
- 2 または を押して【れんらくさき】に移動します。 を押して選択します。
- 3 または を押して必要なエイリアスまたは ID に移動します。 を押して選択します。
- 4 または を押して【キー プログラム】に移動します。 を押して選択します。
- 5 以下のいずれか 1 つの手順を実行します。
 - 目的の数値キーがエントリに割り当てられていない場合、 または を押して目的の数値キーに移動します。 を押して選択します。
 - 目的の数値キーがエントリに割り当てられている場合、ディスプレイに【しようちゅうキー】と表示され、テキスト行の 1 行目に【うわがき?】と表示されます。以下のいずれか 1 つの手順を実行します。

 または  を押して【はい】に移動します。
 を押して選択します。

無線機からはポジティブ インジケータ トーンが聞こえ、ディスプレイに【れんらくさきほぞんずみ】およびポジティブ ミニ通知が表示されます。

前の手順に戻るには、 または  を押して【いいえ】に移動します。



各エントリは、さまざまな数値キーに割り当てられます。エントリに割り当てられる各数値キーの前に  が表示されます。 が【なし】の前にある場合、その数値キーは割り当てられていません。数値キーが特定のモードのエントリに割り当てられている場合、別のモードで数値キーを長く押ししても、この機能は使用できません。



前のメニューに自動的に戻ります。



エントリとプログラミング可能な数値キー間の関連付けの削除



下記の手順に従って、無線機でエントリとプログラミング可能な数値キー間の関連付けを削除します。

- 以下のいずれか 1 つの手順を実行します。
 - プログラムされた数値キーを長押しして必要なエイリアスまたは ID に移動します。[ステップ 4](#)に進みます。
 -  を押してメニューにアクセスします。

-  または  を押して【れんらくさき】に移動します。 を押して選択します。

-  または  を押して必要なエイリアスまたは ID に移動します。 を押して選択します。

-  または  を押して【キー プログラム】に移動します。 を押して選択します。

-  または  を押して【なし】に移動します。 を押して選択します。

テキスト行の 1 行目に、【ぜんキーからさくじよしますか】と表示されます。

6  または  を押して【はい】に移動します。

 を押して選択します。



注記:



エントリが削除されたら、エントリとそのプログラミングされた数値キー間の関連付けは、削除されます。



ポジティブインジケータトーンが鳴ります。ディスプレイに【れんらくさきほぞんずみ】と表示されます。前のメニューに自動的に戻ります。



新規連絡先の追加

下記の手順に従って、無線機で新規連絡先を追加します。

1  を押してメニューにアクセスします。



2  または  を押して【れんらくさき】に移動します。  を押して選択します。

3  または  を押して【しんき とうろく】に移動します。  を押して選択します。

4  または  を押して、連絡先タイプを【むせん リスト】または【電話 リスト】から選択します。  を押して選択します。

5 キーパッドを使用して連絡先番号を入力し、  を押して先に進みます。

6 キーパッドを使用して連絡先名を入力し、  を押して先に進みます。

7  または  を押して必要な着信音タイプに移動します。  を押して選択します。

ポジティブインジケータトーンが鳴ります。ディスプレイにポジティブミニ通知が表示されます。



通話インジケータ設定



この機能を使用すると、無線機ユーザーが通話やテキストメッセージの着信音を設定できます。



着信音のオンとオフの切り替え (個別コール用)



下記の手順に従って、無線機で個別コール受信時の着信音のオンとオフを切り替えます。



- 1  を押してメニューにアクセスします。



- 2  または  を押して [せってい] に移動します。  を押して選択します。

- 3  または  を押して [きのうせってい] に移動します。  を押して選択します。

- 4  または  を押して [トーン/アラート] に移動します。  を押して選択します。

- 5  または  を押して [ちやくしんおん] に移動します。  を押して選択します。

- 6  または  を押して [こべつコール] に移動します。  を押して選択します。



- 7  または  を押して必要なトーンに移動します。  を押して選択します。



有効にすると、✓が [ゆうこう] の隣に表示されます。無効な場合、✓が [ゆうこう] の隣で非表示になります。



着信音のオンとオフの切り替え (テキストメッセージ用)



下記の手順に従って、無線機でテキストメッセージ受信時の着信音のオン/オフを切り替えます。





- 1  を押してメニューにアクセスします。





2  または  を押して【せってい】に移動します。 を押して選択します。

3  または  を押して【きのうせってい】に移動します。 を押して選択します。

4  または  を押して【トーン/アラート】に移動します。 を押して選択します。

5  または  を押して【ちやくしんおん】に移動します。 を押して選択します。



6  または  を押して【テキスト メッセージ】に移動します。 を押して選択します。ディスプレイに  と現在のトーンが表示されます。



7  または  を押して必要なトーンに移動します。 を押して選択します。ディスプレイに、 と選択したトーンが表示されます。



着信音のオンとオフの切り替え (ページング用)



下記の手順に従って、無線機でページング受信時の着信音のオンとオフを切り替えます。



1  を押してメニューにアクセスします。



2  または  を押して【せってい】に移動します。 を押して選択します。

3  または  を押して【きのうせってい】に移動します。 を押して選択します。

4  または  を押して【トーン/アラート】に移動します。 を押して選択します。

5  または  を押して【ちゃくしんおん】に移動します。  を押して選択します。



6  または  を押して【ページング】に移動します。  を押して選択します。



7  または  を押して必要なトーンに移動します。  を押して選択します。ディスプレイに、✓と選択したトーンが表示されます。



着信音のオンとオフの切り替え (選択コール用)



下記の手順に従って、無線機で選択コール受信時の着信音のオン/オフを切り替えます。



1  を押してメニューにアクセスします。



2  または  を押して【せってい】に移動します。  を押して選択します。

3  または  を押して【きのうせってい】に移動します。  を押して選択します。

4  または  を押して【トーン/アラート】に移動します。  を押して選択します。













5  または  を押して【ちゃくしんおん】に移動します。  を押して選択します。





6  または  を押して【せんたくコール】に移動します。  を押して選択します。ディスプレイに ✓と現在のトーンが表示されます。

7  または  を押して必要なトーンに移動します。  を押して選択します。ディスプレイに、✓と選択したトーンが表示されます。

着信音のオンとオフの切り替え (テキスト付きテレメータステータス用)





下記の手順に従って、無線機でテレメータステータス用着信音のオン/オフを切り替えます。



- 1  を押してメニューにアクセスします。
- 2  または  を押して【せってい】に移動します。 を押して選択します。
- 3  または  を押して【きのうせってい】に移動します。 を押して選択します。
- 4  または  を押して【トーン/アラート】に移動します。 を押して選択します。
- 5  または  を押して【ちゃくしんおん】に移動します。 を押して選択します。



- 6  または  を押して【テレメトリ】に移動します。 を押して選択します。
現在のトーンは、 で示されます。



着信音スタイルの割り当て





特定の連絡先から個別通話、ページング、またはテキストメッセージを受信したときに、事前定義された 11 個の着信音のいずれか 1 つが鳴るように、無線機をプログラムできます。リストを操作すると、各着信音スタイルが鳴ります。下記の手順に従って、無線機の着信音スタイルを割り当てます。

- 1  を押してメニューにアクセスします。
- 2  または  を押して【れんらくさき】に移動します。 を押して選択します。
エント리는アルファベット順にソートされます。

3  または  を押して必要なエイリアスまたは ID に移動します。  を押して選択します。

4  または  を押して「ひょうじへんしゅう」に移動します。  を押して選択します。

5 「ちゃくしんおん」メニューが表示されるまで、 を押します。
現在のトーンは  で示されます。

6  または  を押して必要なトーンに移動します。  を押して選択します。
選択した設定の隣りに  A が表示されます。

警告トーンの音量を上げる

無線機は、無線機通話に応答がない状態が続くと継続的に警告を発するようにプログラムできます。時間が経つにつれて、アラームトーンは自動的に大きくなります。この機能はステップアラートとして知られています。

通話履歴機能

無線機は、最近の発信、応答、不在の個別コールをすべて記録します。最近の通話の表示および管理を行うには、通話履歴機能を使用します。



お使いの無線機のシステム設定に応じて、不在着信アラートを通話履歴に含めることができます。各通話リストでは次のタスクを実行できます。



- 連絡先へのエイリアスまたは ID の保存
- 通話の削除
- すべての通話の削除
- 詳細の表示

最近の通話の表示

下記の手順に従って、無線機で最近の通話を表示します。



1  を押してメニューにアクセスします。

2  または  を押して「つうわりれき」に移動します。  を押して選択します。

- 3  または  を押して優先リストに移動します。オプションは【ふざいちゃくしん】、【へんとうずみ】、および【はっしん】リストです。

 を押して選択します。

ディスプレイに最近のエントリが表示されます。



- 4  または  を押してリストを表示します。



PTT ボタンを押すと、現在ディスプレイに表示されているエイリアスまたは **ID** で、通話を開始できません。



通話リストからのエイリアスまたは ID の保存



下記の手順に従って、通話リストから無線機にエイリアスまたは **ID** を保存します。

- 1  を押してメニューにアクセスします。
-

- 2  または  を押して【つうわりれき】に移動します。  を押して選択します。
-

- 3  または  を押して必要なリストに移動します。  を押して選択します。
-

- 4  または  を押して必要なエイリアスまたは **ID** に移動します。  を押して選択します。
-

- 5  または  を押して【ほかん】に移動します。  を押して選択します。
ディスプレイに表示されているカーソルが点滅します。
-

- 6 必要なエイリアスの残りの文字を入力します。



 を押して選択します。



エイリアスなしで **ID** を格納することができます。
ディスプレイにポジティブミニ通知が表示されます。



通話リストからの通話の削除



下記の手順に従って、通話リストから通話を削除します。





- 1  を押してメニューにアクセスします。

- 2  または  を押して [つうわ りれき] に移動します。  を押して選択します。

- 3  または  を押して必要なリストに移動します。  を押して選択します。
リストが空の場合:
 - トーンが鳴ります。
 - ディスプレイに [リストにありません] と表示されます。

- 4  または  を押して必要なエイリアスまたは ID に移動します。  を押して選択します。



- 5  または  を押して [Delete Entry?] (エントリーをさくじょ?) に移動します。  を押して選択します。



- 6 以下のいずれか 1 つの手順を実行します。
 -  を押して [はい] を選択してエントリを削除します。
ディスプレイに [にゆうりよくさくじょずみ] と表示されます。
 -  または  を押して [いいえ] に移動します。  を押して選択します。
前の画面に戻ります。



通話リストからのすべての通話の削除



下記の手順に従って、通話リストからすべての通話を削除します。





- 1  を押してメニューにアクセスします。

2  または  を押して【つうわ りれき】に移動します。  を押して選択します。

3  または  を押して必要なリストに移動します。  を押して選択します。

4  または  を押して必要なエリアまたは ID に移動します。  を押して選択します。

5  または  を押して【ぜんさくじょ】に移動します。  を押して選択します。



- 6 以下のいずれか 1 つの手順を実行します。
-  を押して【はい】を選択し、すべてのエントリを削除します。
ディスプレイにポジティブ ミニ通知が表示されます。
 -  または  を押して【いいえ】に移動します。  を押して選択します。



前の画面に戻ります。



通話リストからの詳細の表示



下記の手順に従って、通話リストから無線機の詳細を表示します。

1  を押してメニューにアクセスします。

2  または  を押して【つうわ りれき】に移動します。  を押して選択します。

3  または  を押して必要なリストに移動します。  を押して選択します。

4  または  を押して必要なエリアまたは ID に移動します。  を押して選択します。

- 5  または  を押して [しろうさい] に移動します。  を押して選択します。ディスプレイに詳細が表示されます。

ページング操作

ページング機能により、相手が応答できる状態になったらかけ直すよう、特定の無線機ユーザーに警告できます。

この機能は、無線機のエイリアスまたは ID のみに適用され、メニューから [れんらくさき] または [ダイアル] を選択するか、プログラムされた [ワンタッチ アクセス] ボタンからアクセスできます。

Capacity Max では、ページング機能を使用して、無線機のユーザーまたはディスプレイが別の無線機ユーザーにアラートを送信し、時間があるときに発信ユーザーにコールバックするよう依頼することができます。本機能は音声通信を使用しません。

ディーラーまたはシステム管理者はページング操作を以下の 2 つの方法により設定できます。

- ユーザーが **PTT** ボタンを押したときに、個別コールにして通話発信者に直接応答できるように、無線機を設定する。

- ユーザーが **PTT** ボタンを押したときに、他のグループとの通信を継続できるように、無線機を設定する。ページング エントリで **PTT** ボタンを押しても、ユーザーは通話発信者に応答できません。[通話履歴] メニューの不在着信履歴オプションに移動して、ここからページングに
応答する必要があります。

OACSU (Off Air Call Set-Up) 個別コールを使用すると、ユーザーは迅速に応答できますが、FOACSU (Full Off Air Call Set-Up) 個別コールでは、通話にユーザーの確認応答が必要になります。そのため、ページング機能には **OACSU** タイプの通話を使用することが推奨されています。「[個別コール ページ 72](#)」を参照してください。

ページングの発信

下記の手順に従って、無線機でページングを発信します。

- 1 プログラムされた [ワンタッチ アクセス] ボタンを押します。

ディスプレイに [ページング] と無線機のエイリアスと ID が表示されます。緑色の LED が点灯します。

2 確認応答を待ちます。



ページング承認を受信した場合は、ディスプレイにポジティブ ミニ通知が表示されます。

ページング承認を受信していない場合は、ディスプレイにネガティブ ミニ通知が表示されます。



連絡先リストを使用したページングの発信

下記の手順に従って、連絡先リストを使用して無線機でページングを発信します。

1  を押してメニューにアクセスします。

2  または  を押して [れんらくさき] に移動します。  を押して選択します。

3  または  を押して必要なエイリアスまたは ID に移動します。  を押して選択します。

4  または  を押して [ページング] に移動します。  を押して選択します。

ディスプレイに [ページング] と無線機のエイリアスまたは ID が表示されます。緑色の LED が点灯します。

5 確認応答を待ちます。

- ページング承認を受信した場合は、ディスプレイにポジティブ ミニ通知が表示されます。
- ページング承認を受信していない場合は、ディスプレイにネガティブ ミニ通知が表示されます。

ページングへの応答

下記の手順に従って、無線機でページングに応答します。

ページングを受信した場合:

- 反復トーンが鳴ります。
- 黄色の LED が点滅します。

- ディスプレイに通知リストが表示され、ページングとともに、呼び出し元無線機のエイリアスまたは ID が示されます。

ディーラーまたはシステム管理者の設置に応じて、以下の1つを行うことによりページングに応答できます。

- **PTT** ボタンを押し、個別コールを使って発信者に直接応答します。
- **PTT** ボタンを押し、通常のグループ通信を続けます。ページングは通話履歴メニューの不在着信履歴オプションに移動します。不在着信履歴から発信者に応答できます。

詳しくは、「[通知リスト ページ 190](#)」および「[通話履歴機能 ページ 126](#)」を参照してください。

ミュート モード

ミュート モードでは、無線機のすべての音声インジケータを無音にすることができます。

ミュート モード機能を開始すると、緊急操作などの優先度の高い機能を除くすべての音声インジケータがミュートされます。

ミュート モードを終了すると、無線機で、継続中のトーンおよび音声の再生が再開されます。



注記:

これは購入可能な機能です。詳細については、ディーラーまたはシステム管理者にご確認ください。

ミュート モードの有効化

下記の手順に従って、ミュート モードを有効にします。

この機能には、プログラムされた **[ミュート モード]** ボタンからアクセスします。











ミュート モードを有効にすると、次のことが発生します。



- ポジティブ インジケータ トーンが鳴ります。
- ディスプレイに **[ミュート モード オン]** と表示されます。
- 赤色の **LED** ライトの点滅が開始し、ミュート モードが終了するまで点滅したままになります。
- ディスプレイのホーム画面に **[ミュート モード]** アイコンが表示されます。
- 無線機がミュートになります。
- ミュート モード タイマーが、設定された時間のカウントダウンを開始します。

ミュート モード タイマーの設定

ミュート モード タイマーを設定すると、事前設定した所定の時間の間、ミュート モード機能を有効にすることができます。タイマーの時間は、無線機メニューで0.5 ~ 6時間の範囲内に設定できます。ミュート モードは、タイマーの時間が切れると終了します。

タイマーを0のままにすると、プログラムされた【ミュート モード】ボタンを押すまで、無線機は無期限にミュート モードになります。

- 1  を押してメニューにアクセスします。
- 2  または  を押して【せってい】に移動します。  を押して選択します。
- 3  または  を押して【きのうせってい】に移動します。  を押して選択します。
- 4  または  を押して【ミュート タイマー】に移動します。  を押して選択します。

- 5  または  を押して各桁の数値を編集し、  を押します。

ミュート モードの終了

この機能は、ミュート モード タイマーの時間が切れると、自動的に終了します。

ミュートモードを手動で終了するには、次のいずれかの操作を実行します。

- プログラムされた【ミュート モード】ボタンを押します。
- 任意のエントリで **PTT** ボタンを押します。

ミュート モードを無効にすると、次のことが発生します。

- ネガティブ インジケータ トーンが鳴ります。
- ディスプレイに【ミュート モード オフ】と表示されます。
- 点滅する赤い LED が消灯します。
- ホーム画面から【ミュート モード】アイコンが消えます。

- 無線機のミュートが解除され、スピーカーが元の状態に戻ります。
- タイマーの時間が切れていない場合、ミュートモードタイマーが停止します。

**注記:**

ユーザーが音声を送信した場合や、プログラムされていないチャンネルに切り替えた場合も、ミュートモードは終了します。

緊急操作

重大な状況を示すために、緊急アラームが使用されます。いつでも、現在のチャンネルでアクティビティがある場合であっても、緊急操作を開始できます。

Capacity Max では、受信中の無線機は一度に **1** つのみの緊急アラームをサポートできます。**2** つ目の緊急アラームが開始されると、**1** つ目のものより優先されます。

緊急アラームを受信したときに、受信者はアラームを削除してアラームリストを終了することも、**PTT** ボタンを押して非緊急の音声を送信して緊急アラームに応答することもできます。

ディーラーまたはシステム管理者は、プログラムされた **[緊急]** ボタンの押し下げ時間を設定できます。ただし、他のボタンと同様、長押しは除きます。

短押し

0.05 ~ 0.75 秒の間

長押し

1.00 ~ 3.75 秒の間

緊急 ボタンには、緊急のオン/オフ機能が割り当てられています。**緊急** ボタンに割り当てられている操作については、ディーラーに確認してください。

**注記:**

緊急 ボタンの短押しに緊急モードのオンを割り当てると、**緊急** ボタンの長押しには緊急モードの終了が割り当てられます。

緊急 ボタンの長押しに緊急モードのオンを割り当てると、**緊急** ボタンの短押しには緊急モードの終了が割り当てられます。

お使いの無線機は、**3** つの緊急アラームをサポートしています。

- 緊急アラーム
- 通話による緊急アラーム
- 音声ガイドおよび緊急アラーム

また、各アラームには以下のタイプがあります。

レギュラー

無線機がアラーム信号を送信し、音声インジケータと視覚的インジケータのいずれかまたは両方で示されます。

サイレント

無線機がアラーム信号を送信しますが、音声インジケータも視覚的インジケータも示されません。プログラムされた【ホットマイク】送信時間が終了するか、PTT ボタンが押されるまで、スピーカから音が漏れることなく通話を受信します。

音声付きサイレント

音声または視覚的インジケータなしにアラーム信号を送信しますが、着信通話の音はスピーカから聞こえます。



注記:

上記の緊急アラームのいずれか 1 つを、プログラムされた【緊急】ボタンまたは緊急フットスイッチに割り当てることができます。

緊急アラームの送信

この機能では、音声信号ではない緊急アラームを送信します。この機能を使用して、無線機グループにアラートを通知できます。下記の手順に従って、無線機で緊急アラームを送信します。

お使いの無線機がサイレントに設定されている場合、緊急モード中にオーディオや視覚的インジケータは一切表示されません。

1 プログラムされた【緊急オン】ボタンを押します。

次のいずれかが表示されます。

- ディスプレイに【Tx アラーム】および宛先のエイリアスが表示されます。
- 【Tx テレグラム】および宛先のエイリアスが表示されます。

緑色の LED が点灯します。【緊急】アイコンが表示されます。



注記:

プログラムされている場合は、緊急検索トーンが鳴ります。このトーンは、無線機で音声を送受信するときにはミュートされ、緊急モードが終了すると停止されます。緊急検索トーンはディーラーまたはシステム管理者がプログラムできます。

2 確認応答を待ちます。

正常に行われた場合:

- 緊急トーンが鳴ります。

- 緑色の LED が点滅します。
- ディスプレイに【アラームそうしん】と表示されます。

再試行がすべて失敗して処理が正常に行われなかった場合:

- トーンが鳴ります。
 - ディスプレイに【アラーム NG】と表示されます。
- 緊急アラーム モードが終了し、ホーム画面に戻ります。



注記:

緊急アラームのみに構成されている場合、緊急プロセスは緊急アラームの提供からのみ構成されます。緊急状態は、システムから確認を受けるか、チャネルアクセスの試行回数を終えると終了します。

緊急アラームのみとして機能する場合、音声通話は緊急アラームの送信に関連付けられません。

通話による緊急アラームの送信

この機能では、通話による緊急アラームを無線機グループまたはディスパッチャに送信します。グループ内のインフ

ラストラクチャから確認応答があると、無線機グループは、プログラムされた緊急チャンネルで通信できます。

無線機は、アラーム プロセス後に緊急通話を行うために、緊急アラームと通話を設定しておく必要があります。

1 プログラムされた【緊急オン】ボタンを押します。

【Tx アラーム】および宛先のエイリアスが表示されます。【緊急】アイコンが表示されます。緑色の LED が点灯します。



注記:

プログラムされている場合は、緊急検索トーンが鳴ります。このトーンは、無線機で音声を送受信するときにはミュートされ、緊急モードが終了すると停止されます。

緊急アラームの確認応答の受信に成功すると:

- 緊急トーンが鳴ります。
- 緑色の LED が点滅します。
- ディスプレイに【アラームそうしん】と表示されます。
- ディスプレイに【きんきゅう】と宛先グループのエイリアスが表示されると、無線機が緊急通話モードに入ります。

緊急アラームの確認応答の受信に失敗すると:

- すべての再試行が終了します。
- 低いトーンが鳴ります。
- ディスプレイに【アラーム NG】と表示されます。
- 無線機が緊急アラーム モードを終了します。

2 PTT ボタンを押して音声送信を開始します。

緑色の LED が点灯します。ディスプレイに、【グループ コール】アイコンが表示されます。

3 以下のいずれか 1 つの手順を実行します。

- 通話許可トーンが完了するまで待機し、マイクに向かってはっきりと話します (有効な場合)。
- **PTT** サイドトーンが完了するまで待機し、マイクに向かってはっきりと話してください (有効な場合)。

4 相手の声を聞くには、**PTT** ボタンを放します。

ディスプレイに、発信者とグループのエイリアスが表示されます。

5 チャンネルフリー指示機能が有効な場合、送信無線機で **[PTT]** ボタンが離された瞬間に、短い警告トーンが鳴ります。これは、そのチャンネルが応答できるようになったことを示します。電話に応答するには、**[PTT]** ボタンを押します。

6 **緊急オフ** ボタンを押して、緊急モードを終了します。無線機はホーム画面に戻ります。



注記:

通話許可トーンが鳴るかどうかは、無線機のプログラムによって異なります。緊急に関する無線機のプログラム内容の詳細については、無線機のディーラーまたはシステム管理者にお問い合わせください。

緊急通話の発信者は、 を押して、進行中の緊急通話を終了できます。無線機は通話アイドル状態に戻りますが、緊急通話画面は開いたままです。

緊急アラームと音声ガイドの送信

この機能では、緊急アラームと音声ガイドを無線機グループに送信します。無線機のマイクは自動的に有効になり、

PTT ボタンを押さずに無線機グループと通信できます。このアクティブな状態のマイクを "ホット マイク" と呼びます。

**注記:**

無線機は、背面アクセサリ コネクタに接続されている **IMPRES** 以外のマイクを検出することができません。

指定されたプログラム済みコネクタでマイクが検出されない場合、無線機は代わりとなるコネクタを調べます。ここで、無線機は検出されたマイクを優先します。

緊急サイクル モードが有効な場合、プログラムされた期間、"ホット マイク" と受信期間が繰り返されます。緊急サイクル モードでは、受信コールの音はスピーカから聞こえます。

プログラムされた受信期間に **PTT** ボタンを押すと、通話禁止音が聞こえます。これは、**PTT** ボタンを放す必要があることを示します。**PTT** ボタンが押されたことは無視され、緊急モードが保たれます。

ホット マイクが有効なときに **[PTT]** ボタンを押し、ホット マイクの期限が切れた後もそのまま押し続けていた場合は、**[PTT]** ボタンを放すまで無線機は送信を続けます。

緊急アラームのリクエストに失敗すると、無線機はそのリクエストを再送信せず、直接 "ホット マイク" 状態に入ります。

**注記:**

"ホット マイク" を使用できないアクセサリもあります。詳細については、ディーラーまたはシステム管理者にご確認ください。

下記の手順に従って、無線機で緊急アラームと音声ガイドを送信します。

- 1 プログラムされた **[緊急オン]** ボタンまたは**緊急** フットスイッチを押します。

以下のいずれかの結果が表示されます。

- **[Tx アラーム]** および宛先のエイリアスが表示されます。
- **[Tx テレグラム]** および宛先のエイリアスが表示されます。

緑色の **LED** が点灯します。 **緊急** アイコンが表示されます。

-
- 2 ディスプレイに **[アラームそうしん]** と表示されたら、マイクに向かってはっきりと話します。

次の場合、無線機は自動的に送信を終了します。

- 緊急サイクルモードが有効で、"ホット マイク"と通話受信のサイクルの期限が切れた場合。
 - 緊急サイクルモードが無効で、"ホット マイク"の期限が切れた場合。
- ディスプレイに、緊急アラーム リスト、緊急トークグループ ID またはエイリアス、および発信中の無線機の ID またはエイリアスが表示されます。

-
- 3 緊急オフ** ボタンを押して、緊急モードを終了します。無線機はホーム画面に戻ります。
-

緊急アラームの受信

受信側無線機は一度に 1 つのみの緊急アラームをサポートできます。2 つ目の緊急アラームが開始されると、1 つ目のものより優先されます。下記の手順に従って、無線機で緊急アラームを受信して閲覧します。

緊急アラームを受信した場合:

- トーンが鳴ります。
- 赤色の LED が点滅します。

-
- 1**  を押してアラームを表示します。
-

- 2**  を押し、アラーム リストでアクションのオプションとエントリの詳細を閲覧します。
-

- 3** アラーム リストを終了するには、 を押して [はい] を選択します。

無線機はホーム画面に戻り、未解決の緊急アラームを示す **[きんきゅうアイコン]** が上部に表示されます。アラーム リストのエントリを削除すると、**[きんきゅう]** アイコンは消えます。

- 4**  を押してメニューにアクセスします。
-

- 5** [アラーム] を選択すると、アラーム リストが再表示されます。
-



- 6** 緊急モードを終了するまでトーンが鳴り続け、赤色の LED が点滅します。ただし、トーンはミュートす

ことができます。以下のいずれか 1 つの手順を実行します。

- 緊急アラームを受信した無線機グループを呼び出すには、**PTT** ボタンを押します。
- プログラム可能ボタンを押します。

緊急アラームへの応答

緊急アラームを受信したときに、受信者はアラームを削除してアラーム リストを終了することも、**PTT** ボタンを押して非緊急の音声を送信して緊急アラームに応答することもできます。下記の手順に従って、無線機で緊急アラームに応答します。

- 1 緊急アラーム表示が有効になっている場合、無線機が緊急アラームを受信すると、緊急アラーム リストが表示されます。  または  を押して必要なエイリアスまたは ID に移動します。
- 2 チャンネルフリー指示機能が有効な場合、送信無線機で **[PTT]** ボタンが離された瞬間に、短い警告トーンが鳴ります。これは、そのチャンネルが応答できるようになったことを示します。緊急アラームの送信先

と同じグループに緊急でない音声を転送するには、**[PTT]** ボタンを押します。

緑色の LED が点灯します。

- 3 以下のいずれか 1 つの手順を実行します。

- 通話許可トーンが完了するまで待機し、マイクに向かってはっきりと話します (有効な場合)。
- **PTT** サイドトーンが完了するまで待機し、マイクに向かってはっきりと話してください (有効な場合)。

- 4 相手の声を聞くには、**PTT** ボタンを放します。

緊急操作を開始した無線機が応答する場合:

- 赤色の LED が点滅します。
- テキスト行に、**[きんきゅうつうわ]** アイコン、緊急トークグループ ID またはエイリアス、および発信中の無線機の ID またはエイリアスが表示されます。

**注記:**

緊急通話表示が有効になっていない場合、ディスプレイに、**[きんきゅうつうわ]** アイコン、緊急トークグループ ID またはエイリアス、および発信中の無線機の ID またはエイリアスが表示されます。

通話による緊急アラームへの応答

下記の手順に従って、無線機で通話による緊急アラームに
応答します。

緊急通話を受信した場合:

- 緊急通話表示および緊急通話復号化トーンが有効になっている場合、緊急通話トーンが鳴ります。緊急通話表示のみが有効になっている場合、緊急通話トーンは鳴りません。
- ディ스플레이の右上隅に **[きんきゅうつうわ]** アイコンが表示されます。
- テキスト行に、緊急トークグループ ID またはエイリアス、および発信中の無線機の ID またはエイリアスが表示されます。

- 無線機のミュートが解除され、着信通話の音はスピーカから聞こえます。

- 1 チャネルフリー指示機能が有効な場合、送信無線機で **[PTT]** ボタンが離された瞬間に、短い警告トーンが鳴ります。これは、そのチャンネルが応答できるようになったことを示します。電話に応答するには、**[PTT]** ボタンを押します。
緑色の LED が点灯します。

- 2 通話許可トーンが完了するまで待機し、マイクに向かってはっきりと話します (有効な場合)。

- 3 相手の声を聞くには、**PTT** ボタンを放します。

緊急操作を開始した無線機が応答する場合:

- 赤色の LED が点滅します。
- テキスト行に、**[きんきゅうつうわ]** アイコン、緊急トークグループ ID またはエイリアス、および発信中の無線機の ID またはエイリアスが表示されます。

**注記:**

緊急通話表示が有効になっていない場合、ディスプレイに、**[きんきゅうつうわ]** アイコン、緊急トークグループ ID またはエイリアス、および発信中の無線機の ID またはエイリアスが表示されます。

ステータス メッセージ

この機能を使用すると、ステータス メッセージを他の無線機に送信できます。

CPS-RM を使用してクイック ステータス リストを設定し、最大 **99** のステータスを含めることができます。

各ステータス メッセージの最大長は、**16** 文字です。

**注記:**

各ステータスには、対応する **0 ~ 99** の範囲のデジタル値があります。簡単に参照できるように、各ステータスにエイリアスを指定できます。

ステータス メッセージの送信

下記の手順に従って、ステータス メッセージを送信します。

- 1 以下のいずれか 1 つの手順を実行します。

- プログラムされた **[ワンタッチ アクセス]** ボタンを押します。以下の手順をスキップします。
- を押してメニューにアクセスします。

- 2 または を押して **[ステータス]** に移動します。 を押して選択します。

- 3 または を押して **[クイック ステータス]** に移動します。 を押して選択します。

- 4 または を押して必要なステータス メッセージに移動します。 を押して選択します。

- 5 または を押して、必要な無線機のエイリアスまたは ID、あるいはグループのエイリアスまたは ID に移動します。 を押して選択します。

正常に行われた場合:

- ポジティブ インジケータ トーンが鳴ります。
- LED がオフになります。

- ディスプレイにポジティブ ミニ通知が 1 回だけ表示された後、[クイック ステータス] 画面に戻ります。
- ディスプレイには、送信されたステータス メッセージの隣に ✓ が表示されます。



正常に行われなかった場合:



- ネガティブ インジケータ トーンが鳴ります。
- LED がオフになります。
- ディスプレイに失敗通知が 1 回だけ表示された後、[クイック ステータス] 画面に戻ります。

プログラム可能ボタンを使用したステータス メッセージの送信

下記の手順に従って、プログラム可能ボタンを使用してステータス メッセージを送信します。

- 1 プログラムされた [ステータス メッセージ] ボタンを押します。

- 2  または  を押して必要なステータス メッセージに移動します。  を押して選択します。連絡先リストが表示されます。

- 3  または  を押して、必要な無線機のエアリアスまたは ID、あるいはグループのエアリアスまたは ID に移動します。  を押して選択します。

正常に行われた場合:











- ポジティブ インジケータ トーンが鳴ります。
- LED がオフになります。
- ディスプレイにポジティブ ミニ通知が 1 回だけ表示された後、[クイックステータス] 画面に戻ります。
- ディスプレイには、送信されたステータス メッセージの隣に ✓ が表示されます。



正常に行われなかった場合:

- ネガティブ インジケータ トーンが鳴ります。
- LED がオフになります。
- ディスプレイに失敗通知が 1 回だけ表示された後、[クイックステータス] 画面に戻ります。

連絡先リストを使用したステータスメッセージの送信

下記の手順に従って、連絡先リストを使用してステータスメッセージを送信します。

- 1  を押してメニューにアクセスします。
- 2  または  を押して「れんらくさき」に移動します。  を押して選択します。
- 3  または  を押して、必要な無線機のエイリアスまたは ID、あるいはグループのエイリアスまたは ID に移動します。  を押して選択します。
- 4  または  を押して「ステータス送信」に移動します。  を押して選択します。

- 5  または  を押して必要なステータスメッセージに移動します。  を押して選択します。

正常に行われた場合:











- ポジティブ インジケータ トーンが鳴ります。
- LED がオフになります。
- ディスプレイにポジティブ ミニ通知が 1 回だけ表示された後、「クイックステータス」画面に戻ります。
- ディスプレイには、送信されたステータス メッセージの隣に ✓ が表示されます。



正常に行われなかった場合:



- ネガティブ インジケータ トーンが鳴ります。
- LED がオフになります。
- ディスプレイに失敗通知が 1 回だけ表示された後、「クイックステータス」画面に戻ります。

ダイアルを使用したステータス メッセージの送信

下記の手順に従って、ダイアルを使用してステータス メッセージを送信します。

- 1  を押してメニューにアクセスします。
- 2  または  を押して【れんらくさき】に移動します。  を押して選択します。
- 3  または  を押して【ダイアル】に移動します。  を押して選択します。
- 4  または  を押して【むせんきばんごう】に移動します。  を押して選択します。
- 5 必要な無線機のエイリアスまたは ID、あるいはグループのエイリアスまたは ID を入力し、  を押して処理を続行します。

- 6  または  を押して【ステータス送信】に移動します。  を押して選択します。

- 7  または  を押して必要なステータス メッセージに移動します。  を押して選択します。

正常に行われた場合:

- ポジティブ インジケータ トーンが鳴ります。
- LED がオフになります。
- ディスプレイにポジティブ ミニ通知が 1 回だけ表示された後、【クイックステータス】画面に戻ります。
- ディスプレイには、送信されたステータス メッセージの隣に  が表示されます。



正常に行われなかった場合:



- ネガティブ インジケータ トーンが鳴ります。
- LED がオフになります。
- ディスプレイに失敗通知が 1 回だけ表示された後、【クイックステータス】画面に戻ります。



ステータス メッセージの表示

下記の手順に従って、ステータス メッセージを表示します。

- 1  を押してメニューにアクセスします。

- 2  または  を押して【ステータス】に移動します。  を押して選択します。

- 3  または  を押して【じゅしん BOX】に移動します。  を押して選択します。



- 4  または  を押して必要なステータス メッセージに移動します。  を押して選択します。
ステータス メッセージの内容が、無線機ユーザーに表示されます。



受信したステータス メッセージは、通知リストにアクセスしても表示できます。詳細については、「[通知リスト ページ 190](#)」を参照してください。



ステータス メッセージへの応答

下記の手順に従って、ステータス メッセージに応答します。



- 1  を押してメニューにアクセスします。



- 2  または  を押して【ステータス】に移動します。  を押して選択します。

- 3  または  を押して【じゅしん BOX】に移動します。  を押して選択します。

- 4  または  を押して必要なステータス メッセージに移動します。  を押して選択します。

- 5 ステータスの内容が表示されます。  を押して選択します。

- 6  または  を押して【へんしん】に移動します。  を押して選択します。

- 7  または  を押して必要なステータスメッセージに移動します。  を押して選択します。

正常に行われた場合:















- ポジティブインジケータ トーンが鳴ります。
- LED がオフになります。
- ディスプレイにポジティブミニ通知が表示された後、【じゅしん BOX】画面に戻ります。
- ディスプレイには、送信されたステータスメッセージの隣に  が表示されます。



正常に行われなかった場合:

- ネガティブインジケータ トーンが鳴ります。
- LED がオフになります。
- ディスプレイに失敗通知が 1 回だけ表示された後、【じゅしん BOX】画面に戻ります。

ステータス メッセージの削除

下記の手順に従って、ステータスメッセージを無線機から削除します。











- 1  を押してメニューにアクセスします。
-
- 2  または  を押して【ステータス】に移動します。  を押して選択します。
-
- 3  または  を押して【じゅしん BOX】に移動します。  を押して選択します。
-
- 4  または  を押して必要なステータスメッセージに移動します。  を押して選択します。
-
- 5 ステータスの内容が表示されます。  を押して選択します。
-
- 6  または  を押して【さくじょ】に移動します。  を押して選択します。



- 7  または  を押して [はい] に移動します。
 を押して選択します。

- ディスプレイにポジティブ ミニ通知が表示された後、[じゅしん BOX] 画面に戻ります。

すべてのステータス メッセージの削除

下記の手順に従って、無線機からすべてのステータス メッセージを削除します。

- 1  を押してメニューにアクセスします。
- 2  または  を押して [ステータス] に移動します。
 を押して選択します。
- 3  または  を押して [じゅしん BOX] に移動します。
 を押して選択します。
- 4  または  を押して [ぜんさくじよ] に移動します。
 を押して選択します。

- 5  または  を押して [はい] に移動します。
 を押して選択します。

- ディスプレイに [リストにありません] と表示されます。

テキスト メッセージング

無線機は、他の無線機やテキスト メッセージ アプリケーションからテキスト メッセージなどのデータを受信できます。

テキスト メッセージには、デジタル車載型無線機 (DMR) ショート テキスト メッセージと、テキスト メッセージの 2 種類があります。DMR ショート テキスト メッセージの最大長は 23 文字です。テキスト メッセージの最大長は、件名を含めて 280 文字です。件名は、電子メール アプリケーションからメッセージを受信した場合にのみ表示されません。



注記:

この最大長は、ソフトウェアとハードウェアが最新のモデルにのみ適用されます。ソフトウェアやハードウェアが古い無線機モデルでは、最大長は 140 文字です。詳細については、ディーラーまたはシステム管理者にご確認ください。







テキスト メッセージ

テキスト メッセージは受信 BOX に保存され、新しく受信した順番にソートされます。



無線機は、無操作タイマーの終了後に、現在の画面を終了します。 を長く押すと、いつでもホーム画面に戻ります。

テキスト メッセージの表示

下記の手順に従って、無線機でテキスト メッセージを表示します。







- 1  を押してメニューにアクセスします。
- 2  または  を押して【メッセージ】に移動します。 を押して選択します。
- 3  または  を押して【じゅしん BOX】に移動します。 を押して選択します。
受信 BOX が空の場合:



- ディスプレイに【リストにありません】と表示されます。
- キー操作音がオンであればトーンが鳴ります。

- 4  または  を押して必要なメッセージに移動します。 を押して選択します。
メッセージが電子メール アプリケーションから送信された場合は、件名の行が表示されます。

テレメータ ステータス メッセージの表示

下記の手順に従って、受信 BOX 内のテレメータ ステータス メッセージを表示します。

- 1  を押してメニューにアクセスします。
- 2  または  を押して【メッセージ】に移動します。 を押して選択します。
- 3  または  を押して【じゅしん BOX】に移動します。 を押して選択します。

- 4  または  を押して必要なメッセージに移動します。  を押して選択します。

テレメータ ステータス メッセージに返信することはできません。

ディスプレイに【テレメータ:】と表示されます。<ステータス メッセージ>

- 5 ホーム画面に戻るには、 を長押しします。

テキスト メッセージへの応答

下記の手順に従って、無線機でテキスト メッセージに応答します。

テキスト メッセージを受信する場合:









- ディスプレイに通知リストが表示され、送信者のエイリアスまたは ID が示されます。
- ディスプレイに【メッセージ】アイコンが表示されます。



注記:

PTT ボタンが押されると、警告画面が終了し、送信者への個別コールまたはグループ コールが開始されます。

- 1 以下のいずれか 1 つの手順を実行します。

-  または  を押して【ひょうじ】に移動します。  を押して選択します。ディスプレイにテキスト メッセージが表示されます。メッセージが電子メール アプリケーションから送信された場合は、件名の行が表示されません。
-  または  を押して【あとでひょうじ】に移動します。  を押して選択します。テキスト メッセージを受信する前の画面に戻ります。
-  または  を押して【さくじょ】に移動します。  を押して選択します。

- 2 以下のいずれか 1 つの手順を実行します。



-  を押して【じゅしん BOX】に戻ります。



-  をもう一度押して、テキスト メッセージの返信、転送、または削除を行います。
-



クイック テキストによるテキスト メッセージへの返信

下記の手順に従って、無線機でクイック テキスト メッセージでテキスト メッセージに返信します。

- 1 以下のいずれか 1 つの手順を実行します。
 - プログラムされた【メッセージ】ボタンを押します。手順 3 に進みます。
 -  を押してメニューにアクセスします。
-



- 2  または  を押して【メッセージ】に移動します。  を押して選択します。
-



- 3  または  を押して【じゅしん BOX】に移動します。  を押して選択します。
-



- 4  または  を押して必要なメッセージに移動します。  を押して選択します。

メッセージが電子メールアプリケーションから送信された場合は、件名の行が表示されます。

- 5  を押してサブメニューにアクセスします。
-

- 6  または  を押して【へんしん】に移動します。  を押して選択します。
-

- 7  または  を押して【クイックへんしん】に移動します。  を押して選択します。
-

- 8  または  を押して必要なメッセージに移動します。  を押して選択します。
ディスプレイに経過に関するミニ通知が表示され、メッセージが送信中であることが示されます。
-

9 確認応答を待ちます。

正常に行われた場合:

- トーンが鳴ります。
- ディスプレイにポジティブ ミニ通知が表示されます。

正常に行われなかった場合:

- トーンが鳴ります。
- ディスプレイにネガティブ ミニ通知が表示されます。
- 無線機で【さいそうしん】オプション画面が再び表示されます。

- ポジティブ インジケータ トーンが鳴ります。
- ディスプレイにポジティブ ミニ通知が表示されます。

正常に行われなかった場合:

- ネガティブ インジケータ トーンが鳴ります。
- ディスプレイにネガティブ ミニ通知が表示されます。
- 無線機で【さいそうしん】オプション画面が再び表示されます。

テキスト メッセージの再送信

下記の手順に従って、無線機でテキスト メッセージを再送信します。

【さいそうしん】オプション画面が表示されている場合:



 を押して、同じ無線機、グループのエイリアス、または ID に、同じメッセージを再送信します。



正常に行われた場合:

テキスト メッセージの転送

下記の手順に従って、無線機でテキスト メッセージを転送します。

【さいそうしん】オプション画面が表示されている場合:

- 1  または  を押して【てんそう】に移動し、
 を押して同じメッセージを別の無線機またはグループのエイリアスまたは ID に送信します。

- 2  または  を押して必要なエリアまたは ID に移動します。  を押して選択します。ディスプレイに経過に関するミニ通知が表示され、メッセージが送信中であることが示されます。
-

3 確認応答を待ちます。

正常に行われた場合:

- トーンが鳴ります。
- ディスプレイにポジティブ ミニ通知が表示されます。

正常に行われなかった場合:

- トーンが鳴ります。
- ディスプレイにネガティブ ミニ通知が表示されます。







注記:



ターゲット無線機のアドレスを手動で選択することもできます(「[ダイアルを使用したテキストメッセージの転送 ページ 443](#)」を参照)。

ダイアルを使用したテキストメッセージの転送

下記の手順に従って、無線機でダイアルを使用してテキストメッセージを転送します。

- 1  または  を押して【てんそう】に移動します。  を押して選択します。
-

- 2  を押して、別の無線機、グループのエリアス、または ID に同じメッセージを送信します。
-

- 3  または  を押して【ダイアル】に移動します。  を押して選択します。ディスプレイに【むせん ID:】と表示されます。
-

- 4 無線機の ID を入力し、  を押して先に進みます。ディスプレイに経過に関するミニ通知が表示され、メッセージが送信中であることが示されます。
-

5 確認応答を待ちます。

正常に行われた場合:

- トーンが鳴ります。
- ディスプレイにポジティブ ミニ通知が表示されます。

正常に行われなかった場合:

- トーンが鳴ります。
- ディスプレイにネガティブ ミニ通知が表示されます。



テキスト メッセージの編集

【へんしゅう】を選択してメッセージを編集します。







注記:

件名行が存在する場合 (電子メール アプリケーションから受信したメッセージの場合)、この行は編集できません。

- 1  または  を押して【へんしゅう】に移動します。  を押して選択します。



ディスプレイに表示されているカーソルが点滅します。





- 2 キーパッドを使用してメッセージを編集します。

-  を押して、スペース 1 つ分左側に移動します。
-  または  を押すと、スペース 1 つ分右側に移動します。
-  を押して、不要な文字を削除します。
-  を長押しすると、テキスト入力方法が変更されます。

- 3 メッセージが完成したら、  を押します。

- 4 以下のいずれか 1 つの手順を実行します。



-  または  を押して【そうしん】に移動し、  を押してメッセージを送信します。



-  または  を押して【ほぞん】に移動し、 を押してメッセージを下書きフォルダに保存します。
-  を押してメッセージを編集します。
-  を押してメッセージを削除するか、下書きフォルダにこのメッセージを保存します。

テキスト メッセージの入力

下記の手順に従って、無線機でテキスト メッセージを作成します。



- 1 以下のいずれか 1 つの手順を実行します。
 - プログラムされた【メッセージ】ボタンを押します。ステップ 3 に進みます。
 -  を押してメニューにアクセスします。

- 2  または  を押して【メッセージ】に移動します。 を押して選択します。

- 3  または  を押して【へんしゅう】に移動します。 を押して選択します。点滅するカーソルが表示されます。

- 4 キーパッドを使用してメッセージを入力します。

 を押して、スペース 1 つ分左側に移動します。





 または  を押すと、スペース 1 つ分右側に移動します。

 を押して、不要な文字を削除します。

 を長押しすると、テキスト入力方法が変更されます。

- 5 メッセージが完成したら、 を押します。以下のいずれか 1 つの手順を実行します。

-  を押してメッセージを送信します。







-  を押します。 または  を押して、メッセージの編集、削除または保存の中から選択します。 を押して選択します。
-

テキスト メッセージの送信

下記の手順に従って、無線機でテキスト メッセージを送信します。

新規作成したテキスト メッセージまたは保存されたテキスト メッセージがあると仮定します。

メッセージ受信者を選択します。以下のいずれか 1 つの手順を実行します。

-  または  を押して必要なエイリアスまたは ID に移動します。 を押して選択します。
-  または  を押して【ダイヤル】に移動します。 を押して選択します。無線機の ID を入力します。ディスプレイの 1 行目に【むせん ID:】と表示されます。ディスプレイの 2 行目に、点滅するカーソルが表示されます。無線

機のエイリアスまたは ID を入力します。 を押します。

ディスプレイに経過に関するミニ通知が表示され、メッセージが送信中であることが示されます。

正常に行われた場合:

- トーンが鳴ります。
- ディスプレイにポジティブ ミニ通知が表示されます。

正常に行われなかった場合:

- 低いトーンが鳴ります。
- ディスプレイにネガティブ ミニ通知が表示されます。
- メッセージが【送信済みアイテム】フォルダに移動します。
- メッセージに【送信失敗】アイコンが付きます。







注記:



新規作成されたテキスト メッセージの場合、無線機は【さいそうしん】オプション画面に戻ります。



受信 BOX からのテキスト メッセージの削除

下記の手順に従って、無線機で受信 BOX からテキスト メッセージを削除します。



- 1 以下のいずれか 1 つの手順を実行します。
 - プログラムされた **[メッセージ]** ボタンを押します。 **ステップ 3** に進みます。
 -  を押してメニューにアクセスします。



- 2  または  を押して **[メッセージ]** に移動します。  を押して選択します。

- 3  または  を押して **[じゅしん BOX]** に移動します。  を押して選択します。
受信 BOX が空の場合:
 - ディスプレイに **[リストがありません]** と表示されます。
 - トーンが鳴ります。

- 4  または  を押して必要なメッセージに移動します。  を押して選択します。
メッセージが電子メールアプリケーションから送信された場合は、件名の行が表示されます。







- 5  を押してサブメニューにアクセスします。



- 6  または  を押して **[さくじょ]** に移動します。  を押して選択します。



- 7  または  を押して **[はい]** に移動します。  を押して選択します。
ディスプレイにポジティブ ミニ通知が表示されません。画面は **[受信トレイ]** に戻ります。

受信 BOX からのすべてのテキスト メッセージの削除

下記の手順に従って、無線機で受信 BOX からすべてのテキスト メッセージを削除します。

- 1 以下のいずれか 1 つの手順を実行します。
 - プログラムされた【メッセージ】ボタンを押します。ステップ 3 に進みます。
 -  を押してメニューにアクセスします。
- 2  または  を押して【メッセージ】に移動します。  を押して選択します。
- 3  または  を押して【じゅしん BOX】に移動します。  を押して選択します。
受信 BOX が空の場合:
 - ディスプレイに【リストがありません】と表示されます。
 - トーンが鳴ります。

- 4  または  を押して【ぜんさくじょ】に移動します。  を押して選択します。

- 5  または  を押して【はい】に移動します。  を押して選択します。

ディスプレイにポジティブ ミニ通知が表示されません。

送信済みテキスト メッセージ

別の無線機に送信されたメッセージは、送信 BOX フォルダに保存されます。最近送信されたテキスト メッセージは、必ず送信 BOX フォルダの一番上に追加されます。送信済みテキスト メッセージの再送信、転送、編集、または削除を実行できます。

送信 BOX フォルダは、最大で 30 件の最近送信されたメッセージを格納できます。フォルダが一杯であるときにテキスト メッセージを送信すると、置き換えとして、フォルダの一番古いテキスト メッセージが自動的に削除されます。

メッセージ送信中にメッセージ送信画面を終了すると、ディスプレイや音声による通知を行わずに、送信 BOX フォルダ内のメッセージのステータスが更新されます。

送信 BOX フォルダ内のメッセージ ステータスが更新される前に、無線機のモードが変更されたり電源がオフになったりすると、実行中のメッセージを完了できなくなり、そのメッセージには自動的に **[送信失敗]** アイコンが表示されます。

無線機では、同時に最大で **5** 件の実行中メッセージを使用できます。この間、新しいメッセージを送信できなくなり、新しいメッセージには自動的に **[送信失敗]** アイコンが表示されます。

 ボタンを長押しすると、無線機はいつでもホーム画面に戻ります。



注記:



従来型デジタル、Capacity Plus チャンネルなど、チャンネルタイプが一致しない場合、送信済みメッセージの編集、転送、または削除のみを行えます。



送信済みテキスト メッセージの表示

下記の手順に従って、無線機で送信済みテキスト メッセージを表示します。

- 以下のいずれか 1 つの手順を実行します。
 - プログラムされた **[メッセージ]** ボタンを押します。 **ステップ 3** に進みます。



-  を押してメニューにアクセスします。

-  または  を押して **[メッセージ]** に移動します。  を押して選択します。

-  または  を押して **[そうしん BOX]** に移動します。  を押して選択します。

[そうしん BOX] フォルダが空の場合:

- ディスプレイに **[リストにありません]** と表示されます。
- キー操作音がオンであれば低い音でトーンが鳴ります。

-  または  を押して必要なメッセージに移動します。  を押して選択します。

画面の右上隅のアイコンは、メッセージのステータスを示します。「**送信 BOX アイコン**」を参照してください。





送信済みテキスト メッセージの送信

下記の手順に従って、無線機で送信済みテキスト メッセージを送信します。

送信済みメッセージを表示する場合:

1  を押します。

2 送信済みテキスト メッセージの再送信または転送を行うことができます。以下のいずれか 1 つの手順を実行します。

-  【さいそうしん】に移動します。  を押して選択します。
-  【てんそう】に移動します。  を押して選択します。

ディスプレイに経過に関するミニ通知が表示され、メッセージが送信中であることが示されます。

3 確認応答を待ちます。

正常に行われた場合:

- トーンが鳴ります。

- ディスプレイにポジティブ ミニ通知が表示されます。

正常に行われなかった場合:



- トーンが鳴ります。
- ディスプレイにネガティブ ミニ通知が表示されます。
- 無線機に【さいそうしん】オプション画面が表示されます。詳細については、「[テキスト メッセージの再送信 ページ 152](#)」を参照してください。

送信 BOX フォルダからの送信済みテキスト メッセージの削除

下記の手順に従って、無線機で送信 BOX フォルダから送信済みテキスト メッセージを削除します。

送信済みメッセージを表示する場合:

1  を押します。

2  または  を押して【さくじょ】に移動します。  を押して選択します。

送信 BOX フォルダからのすべての送信済みテキストメッセージの削除

下記の手順に従って、無線機で送信 BOX フォルダからすべての送信済みテキストメッセージを削除します。

- 以下のいずれか 1 つの手順を実行します。
 - プログラムされた **[メッセージ]** ボタンを押します。 **ステップ 3** に進みます。
 - OK** を押してメニューにアクセスします。

- ▲** または **▼** を押して **[メッセージ]** に移動します。 **OK** を押して選択します。

- ▲** または **▼** を押して **[そうしん BOX]** に移動します。 **OK** を押して選択します。
[そうしん BOX] フォルダが空の場合:
 - ディスプレイに **[リストにありません]** と表示されます。
 - トーンが鳴ります。

- ▲** または **▼** を押して **[ぜんさくじょ]** に移動します。 **OK** を押して選択します。

- 以下のいずれか 1 つの手順を実行します。

- ▲** または **▼** を押して **[はい]** に移動します。 **OK** を押して選択します。
ディスプレイにポジティブミニ通知が表示されます。
- ▲** または **▼** を押して **[いいえ]** に移動します。 **OK** を押して選択します。
前の画面に戻ります。

保存されたテキストメッセージ

下書きフォルダにテキストメッセージを保存し、後でそのテキストメッセージを送信できます。

PTT ボタンを押すか、モードの変更により、メッセージの作成や編集集中にメッセージの作成/編集画面から抜けてしまった場合、現在のメッセージは、下書きフォルダに自動的に保存されます。

最近保存されたテキストメッセージは、常に下書きリストの一番上に追加されます。

下書きフォルダは、最大で 10 件の最近保存されたメッセージを格納します。フォルダが一杯であるときにテキストメッセージを保存すると、フォルダの一番古いテキストメッセージが削除されます。

保存されたテキストメッセージの表示

下記の手順に従って、無線機で保存されたテキストメッセージを表示します。

- 1 以下のいずれか 1 つの手順を実行します。
 - プログラムされた **[メッセージ]** ボタンを押します。 **ステップ 3** に進みます。
 - **[OK]** を押してメニューにアクセスします。

- 2 **[▲]** または **[▼]** を押して **[メッセージ]** に移動します。 **[OK]** を押して選択します。

- 3 **[▲]** または **[▼]** を押して **[したがき]** に移動します。 **[OK]** を押して選択します。

- 4 **[▲]** または **[▼]** を押して必要なメッセージに移動します。 **[OK]** を押して選択します。

保存されたテキストメッセージの編集







下記の手順に従って、無線機に保存されたテキストメッセージを編集します。

- 1 メッセージの表示中に、 **[OK]** を押します。
- 2 **[▲]** または **[▼]** を押して **[へんしゅう]** に移動します。 **[OK]** を押して選択します。点滅するカーソルが表示されます。
- 3 キーパッドを使用してメッセージを入力します。
 - ◀ を押して、スペース 1 つ分左側に移動します。
 - ▶ または **[色井]** を押すと、スペース 1 つ分右側に移動します。
 - ⓧ を押して、不要な文字を削除します。

 を長押しすると、テキスト入力方法が変更されます。

4 メッセージが完成したら、 を押します。

以下のいずれか 1 つの手順を実行します。



-  または  を押して【そうしん】に移動します。 を押してメッセージを送信します。
-  を押します。 または  を押してメッセージの保存または削除を選択します。 を押して選択します。



下書きフォルダに保存したテキスト メッセージの削除



下記の手順に従って、無線機に保存したテキスト メッセージを下書きフォルダから削除します。



- 1 以下のいずれか 1 つの手順を実行します。
 - プログラムされた【メッセージ】ボタンを押します。ステップ 3 に進みます。

-  を押してメニューにアクセスします。

2  または  を押して【メッセージ】に移動します。 を押して選択します。

3  または  を押して【したがき】に移動します。 を押して選択します。

4  または  を押して必要なメッセージに移動します。 を押して選択します。

5  または  を押して【さくじょ】に移動します。 を押してテキスト メッセージを削除します。

クイック テキスト メッセージ



無線機では、ディーラーがプログラミングするクイック テキスト メッセージを最大 50 まで使用できます。



クイック テキスト メッセージは事前定義されていますが、送信前に各メッセージを編集できます。



クイック テキスト メッセージの送信

下記の手順に従って、無線機で事前に定義したクイック テキスト メッセージを事前に定義したエリアスに送信します。

- 以下のいずれか 1 つの手順を実行します。
 - プログラムされた【メッセージ】ボタンを押します。ステップ 3 に進みます。
 - プログラムされた【ワンタッチ アクセス】ボタンを押します。ステップ 6 に進みます。ディスプレイに経過に関するミニ通知が表示され、メッセージが送信中であることが示されます。
 -  を押してメニューにアクセスします。

-  または  を押して【メッセージ】に移動します。  を押して選択します。

-  または  を押して【クイック テキスト】に移動します。  を押して選択します。

-  または  を押して必要なクイック テキスト メッセージに移動します。  を押して選択します。

- 以下の手順で受信者を選択し、メッセージを送信します。

ディスプレイに経過に関するミニ通知が表示され、メッセージが送信中であることが示されます。

- 確認応答を待ちます。

正常に行われた場合:

- ポジティブ インジケータ トーンが鳴ります。
- ディスプレイにポジティブ ミニ通知が表示されます。



正常に行われなかった場合:

- ネガティブ インジケータ トーンが鳴ります。
- ディスプレイにネガティブ ミニ通知が表示されます。

- 無線機に「さいそうしん」オプション画面が表示されます。詳細については、「[テキストメッセージの再送信 ページ 152](#)」を参照してください。



注記:

-  を押すと、いつでも前の画面に戻ります。
-  を長く押すとホーム画面に戻ります。無線機は、無操作タイマーの終了後に、現在の画面を終了します。

テキスト入力設定

お使いの無線機では、さまざまなテキストを設定できます。無線機でのテキストの入力に対して次を設定できます。











- 単語予測
- 単語修正
- 文章大文字修正
- マイワード



利用できるテキスト入力方法は以下のとおりです。

- 数字
- 符号
- 予測またはマルチタップ
- 言語 (プログラムする場合)



文字修正の有効化/無効化



テキスト エディタに入力した単語が組み込み辞書で認識されない場合、単語の代わりの選択肢を提供します。



-  を押してメニューにアクセスします。
-  または  を押して【せってい】に移動します。 を押して選択します。
-  または  を押して【きのうせってい】に移動します。 を押して選択します。
-  または  を押して【もじにゆうりよく】に移動します。 を押して選択します。



5  または  を押して【もじしゅうせい】に移動します。  を押して選択します。



6 以下のいずれか 1 つの手順を実行します。

-  または  を押して【もじしゅうせい】に移動します。  を押して選択します。
- を押して【もじしゅうせい】を有効にします。有効にすると、✓が【ゆうこう】の隣に表示されます。
- を押して【もじしゅうせい】を無効にします。無効な場合、✓が【ゆうこう】の隣で非表示になります。



2  または  を押して【せってい】に移動します。  を押して選択します。

3  または  を押して【きのうせってい】に移動します。  を押して選択します。

4  または  を押して【もじにゆうりよく】に移動します。  を押して選択します。

5  または  を押して【よそく】に移動します。  を押して選択します。

6 以下のいずれか 1 つの手順を実行します。

-  を押して単語予測を有効にします。有効にすると、✓が【ゆうこう】の隣に表示されます。
-  を押してマイク ダイナミックひずみコントロールを無効にします。無効な場合、✓が【ゆうこう】の隣で非表示になります。













単語予測の有効化/無効化



単語予測無線機は、頻繁に入力する語に共通する並び順を学習できます。学習内容をもとに、テキスト エディタに共通する語の並びの最初の単語を入力すると、使用する可能性のある次の語を予測します。

1  を押してメニューにアクセスします。

文章大文字修正







この機能は、新しい文を入力するごとに、最初の語の最初の文字を自動的に大文字にするときに使用します。



- 1  を押してメニューにアクセスします。
- 2  または  を押して【せってい】に移動します。  を押して選択します。
- 3  または  を押して【きのうせってい】に移動します。  を押して選択します。
- 4  または  を押して【もじにゆうりよく】に移動します。  を押して選択します。
- 5  または  を押して【おおもじ】に移動します。  を押して選択します。
- 6 以下のいずれか 1 つの手順を実行します。



-  を押して大文字を有効にします。有効になると、✓が【ゆうこう】の隣に表示されます。
-  を押して大文字を無効にします。無効な場合、✓が【ゆうこう】の隣で非表示になります。



カスタム語の表示

自分のカスタム語を無線機に組み込まれた辞書に追加できます。無線機は、その語を含むリストを管理します。

- 1  を押してメニューにアクセスします。
- 2  または  を押して【せってい】に移動します。  を押して選択します。
- 3  または  を押して【きのうせってい】に移動します。  を押して選択します。

4  または  を押して【もじにゆうりよく】に移動します。  を押して選択します。



5  または  を押して【マイ ワード】に移動します。  を押して選択します。



6  または  を押して【たんご リスト】に移動します。  を押して選択します。
ディスプレイにはカスタム語のリストが表示され
ます。



カスタム語の編集



無線機に保存したカスタム語を編集できます。



1  を押してメニューにアクセスします。



2  または  を押して【せってい】に移動し
ます。  を押して選択します。



3  または  を押して【きのうせってい】に移動します。  を押して選択します。





4  または  を押して【もじにゆうりよく】に移動します。  を押して選択します。

5  または  を押して【マイ ワード】に移動します。  を押して選択します。

6  または  を押して【たんご リスト】に移動します。  を押して選択します。
ディスプレイにはカスタム語のリストが表示され
ます。

7  または  を押して必要な単語に移動し
ます。  を押して選択します。

8  または  を押して【へんしゅう】に移動します。  を押して選択します。

- 9 キーパッドを使用して、カスタム語を編集します。
-  を押して、スペース 1 つ分左側に移動します。
 -  キーを押すと、スペース 1 つ分右側に移動します。
 - 不要な文字を削除するときは、 キーを押します。
 -  を長押しすると、テキスト入力方法が変更されます。
-

10 カスタム語が完成したら、 を押します。



ディスプレイには経過に関するミニ通知が表示され、カスタム語が保存中であることが示されます。



- カスタム語が保存されると、トーンが鳴り、ディスプレイにはポジティブミニ通知が表示されます。
- カスタム語を保存していない場合、低いトーンが鳴り、ディスプレイにネガティブミニ通知が表示されます。



カスタム語の追加



無線機の組み込み辞書に、カスタム語を追加できます。



1  を押してメニューにアクセスします。

2  または  を押して【せってい】に移動します。  を押して選択します。





3  または  を押して【きのうせってい】に移動します。  を押して選択します。

4  または  を押して【もじにゆうりよく】に移動します。  を押して選択します。

5  または  を押して【マイ ワード】に移動します。  を押して選択します。

- 6  または  を押して [しんき つか] に移動します。  を押して選択します。
- ディスプレイにはカスタム語のリストが表示されます。

7 キーパッドを使用して、カスタム語を編集します。

-  を押して、スペース 1 つ分左側に移動します。
-  キーを押すと、スペース 1 つ分右側に移動します。
- 不要な文字を削除するときは、 キーを押します。
-  を長押しすると、テキスト入力方法が変更されます。

8 カスタム語が完成したら、 を押します。













ディスプレイには経過に関するミニ通知が表示され、カスタム語が保存中であることが示されます。



- カスタム語が保存されると、トーンが鳴り、ディスプレイにポジティブミニ通知が表示されます。



- カスタム語を保存していない場合、低いトーンが鳴り、ディスプレイにネガティブミニ通知が表示されます。

カスタム語の削除





下記の手順に従って、無線機に保存したカスタム語を削除します。

- 1  を押してメニューにアクセスします。
- 2  または  を押して [せってい] に移動します。  を押して選択します。
- 3  または  を押して [きのうせってい] に移動します。  を押して選択します。
- 4  または  を押して [もじにゆうりよく] に移動します。  を押して選択します。
- 5  または  を押して [マイ ワード] に移動します。  を押して選択します。

6  または  を押して必要な単語に移動します。  を押して選択します。

7  または  を押して【さくじょ】に移動します。  を押して選択します。



8 次のいずれかを選択します。



- 【エントリをさくじょ?】で  を押して【はい】を選択します。ディスプレイに【にゆうりよくさくじょずみ】と表示されます。
 -  または  を押して【いいえ】に移動します。  を押して前の画面に戻ります。
-



すべてのカスタム語の削除



下記の手順に従って、無線機に組み込まれた辞書からすべてのカスタム語を削除します。



1  を押してメニューにアクセスします。

2  または  を押して【せってい】に移動します。  を押して選択します。

3  または  を押して【きのうせってい】に移動します。  を押して選択します。



4  または  を押して【もじにゆうりよく】に移動します。  を押して選択します。

5  または  を押して【マイ ワード】に移動します。  を押して選択します。

6  または  を押して【ぜんさくじょ】に移動します。  を押して選択します。

7 以下のいずれか 1 つの手順を実行します。

- 【エントリをさくじょ?】で  を押して【はい】を選択します。ディスプレイに【にゆうりよくさくじょずみ】と表示されます。

- 前の画面に戻るには、 または  を押し、て [いいえ] に移動します。 を押して選択します。

JOB チケット

この機能を使用して、実行するタスクを列挙するディスプレイからのメッセージを、無線機で受信できます。



注記:

この機能は、ユーザーの要件に応じて CPS 経由でカスタマイズできます。詳細については、ディーラーまたはシステム管理者にご確認ください。

次の 2 つのフォルダに、異なる種類の JOB チケットが含まれます。

[マイ タスク] フォルダ

ユーザーがサインインに使用したユーザー ID に割り当てられた、個人用の JOB チケット

[共有タスク] フォルダ

ユーザーのグループに割り当てられた共有 JOB チケット

JOB チケットに応答して、チケットを JOB チケット フォルダに並べることができます。既定のフォルダ名は **[All]**、**[New]**、**[Started]**、および **[Completed]** です。追加の 10 個

のフォルダについては、ディーラーかシステム管理者までお問い合わせください。



注記:

JOB チケットは、無線機の電源を入れ直しても保持されます。

[All] フォルダには、すべての JOB チケットが配置されます。お使いの無線機のプログラムに応じて、JOB チケットは、優先度順、次に受信時刻順にソートされます。新規の JOB チケット、状態が最近変化した JOB チケット、および優先度が最高の JOB チケットが、リストの先頭に列挙されます。JOB チケットの最大件数に達すると、最後のチケットが次のチケットに取って代わられます。無線機のモデルに応じて、最大 100 件または 500 件の JOB チケットがサポートされます。詳細については、ディーラーまたはシステム管理者にご確認ください。無線機は、JOB チケット ID が重複している JOB チケットを、自動的に検出して破棄します。

JOB チケットの重要度に応じて、ディスプレイで優先度レベルが追加されます。優先度レベルには、3 段階(優先度 1、優先度 2、優先度 3) あります。優先度 1 が最高の優先度で、優先度 3 が最低の優先度です。その他に、優先度なしの JOB チケットもあります。



ディスプレイが下記の変更を行うと、それによって無線機が更新されます。



- JOB チケットの内容修正。
- JOB チケットの優先度レベルの追加または編集。
- JOB チケットのフォルダからフォルダへの移動。
- JOB チケットのキャンセル。



JOB チケット フォルダへのアクセス

下記の手順に従って、JOB チケット フォルダへアクセスします。

- 1 以下のいずれか 1 つの手順を実行します。
 - プログラムされた **[JOB チケット]** ボタンを押します。ステップ 3 に進みます。
 -  を押してメニューにアクセスします。

- 2  または  を押して [ワーク チケット] に移動します。  を押して選択します。



- 3  または  を押して必要なフォルダに移動します。  を押して選択します。

- 4  または  を押して必要な JOB チケットに移動します。  を押して選択します。

リモート サーバーのログインとログアウト

ユーザー ID を使用して、リモート サーバーへのログインとログアウトが可能です。

- 1  を押してメニューにアクセスします。

- 2  または  を押して [ログイン] に移動します。  を押して選択します。

ログイン済みの場合は、メニューに [ログアウト] と表示されます。

ディスプレイに経過に関するミニ通知が表示され、要求が処理中であることが示されます。

- 3 確認応答を待ちます。
正常に行われた場合:

- ポジティブ インジケータ トーンが鳴ります。
- ディスプレイにポジティブ ミニ通知が表示されます。





正常に行われなかった場合:



- ネガティブ インジケータ トーンが鳴ります。
- ディスプレイにネガティブ ミニ通知が表示されます。

JOB チケットの作成

無線機は JOB チケットを作成できます。これは、JOB チケット テンプレートをベースにしたもので、実行が必要な作業を送信します。











JOB チケット テンプレートを構成するには、CPS プログラミングソフトウェアが必要です。

- 1  を押してメニューにアクセスします。
- 2  または  を押して [JOB チケット] に移動します。  を押して選択します。

- 3  または  を押して [チケットさくせい] に移動します。  を押して選択します。



JOB チケットへの応答

下記の手順に従って、無線機で JOB チケットに応答します。

- 1  を押してメニューにアクセスします。
- 2  または  を押して [JOB チケット] に移動します。  を押して選択します。
- 3  または  を押して必要なフォルダに移動します。  を押して選択します。
- 4  または  を押して必要な JOB チケットに移動します。  を押して選択します。

5 サブメニューにアクセスするには、 を再度押します。

対応する数値キー (1 ~ 9) を押して、**[クイックへんしん]** を行います。

6  または  を押して必要な JOB チケットに移動します。 を押して選択します。

ディスプレイに経過に関するミニ通知が表示され、要求が処理中であることが示されます。

7 確認応答を待ちます。

正常に行われた場合:

- ポジティブ インジケータ トーンが鳴ります。
- ディスプレイにポジティブ ミニ通知が表示されます。



正常に行われなかった場合:



- ネガティブ インジケータ トーンが鳴ります。
 - ディスプレイにネガティブ ミニ通知が表示されます。
-



単数の JOB チケット テンプレートを使った JOB チケットの送信

単数の JOB チケット テンプレートを使って無線機が構成されている場合、JOB チケットを送信するには、次の操作を実行します。

1 キーパッドを使用して、必要な部屋番号を入力します。 を押して選択します。

2  または  を押して **[へやのステータス]** に移動します。 を押して選択します。

3  または  を押して必要なオプションに移動します。 を押して選択します。

4  または  を押して **[そうしん]** に移動します。 を押して選択します。

ディスプレイに経過に関するミニ通知が表示され、要求が処理中であることが示されます。

5 確認応答を待ちます。

正常に行われた場合:



- ポジティブ インジケータ トーンが鳴ります。
- ディスプレイにポジティブ ミニ通知が表示されます。



正常に行われなかった場合:

- ネガティブ インジケータ トーンが鳴ります。
- ディスプレイにネガティブ ミニ通知が表示されます。

複数の JOB チケット テンプレートを使った JOB チケットの送信

複数の JOB チケット テンプレートを使って無線機が構成されている場合、JOB チケットを送信するには、次の操作を実行します。

- 1  または  を押して必要なオプションに移動します。  を押して選択します。

- 2  または  を押して『そうしん』に移動します。  を押して選択します。

ディスプレイに経過に関するミニ通知が表示され、要求が処理中であることが示されます。

3 確認応答を待ちます。

正常に行われた場合:











- ポジティブ インジケータ トーンが鳴ります。
- ディスプレイにポジティブ ミニ通知が表示されます。



正常に行われなかった場合:

- ネガティブ インジケータ トーンが鳴ります。
- ディスプレイにネガティブ ミニ通知が表示されます。



JOB チケットの削除

下記の手順に従って、無線機で JOB チケットを削除します。

- 1 以下のいずれか 1 つの手順を実行します。
 - プログラムされた [JOB チケット] ボタンを押します。ステップ 4 に進みます。
 -  を押してメニューにアクセスします。
- 2  または  を押して [JOB チケット] に移動します。  を押して選択します。
- 3  または  を押して必要なフォルダに移動します。  を押して選択します。
- 4  または  を押して [すべて] フォルダに移動します。  を押して選択します。

- 5  または  を押して必要な JOB チケットに移動します。  を押して選択します。

- 6 JOB チケットの表示中に、  を再度押します。

- 7  または  を押して [さくじょ] に移動します。  を押して選択します。

ディスプレイに経過に関するミニ通知が表示され、要求が処理中であることが示されます。

- 8 確認応答を待ちます。

正常に行われた場合:

- ポジティブ インジケータ トーンが鳴ります。
- ディスプレイにポジティブ ミニ通知が表示されます。



正常に行われなかった場合:



- ネガティブ インジケータ トーンが鳴ります。
- ディスプレイにネガティブ ミニ通知が表示されます。



すべての JOB チケットの削除



下記の手順に従って、無線機のすべての JOB チケットを削除します。







- 1 以下のいずれか 1 つの手順を実行します。
 - プログラムされた [JOB チケット] ボタンを押します。ステップ 3 に進みます。
 -  を押してメニューにアクセスします。

- 2  または  を押して [JOB チケット] に移動します。  を押して選択します。

- 3  または  を押して必要なフォルダに移動します。  を押して選択します。

- 4  または  を押して [すべて] フォルダに移動します。  を押して選択します。

- 5  または  を押して [ぜんさくじょ] に移動します。  を押して選択します。

- 6 以下のいずれか 1 つの手順を実行します。
 -  または  を押して [はい] に移動します。  を押して選択します。ディスプレイにポジティブミニ通知が表示されます。
 -  または  を押して [いいえ] に移動します。  を押して選択します。前の画面に戻ります。

プライバシー

この機能は、ソフトウェアベースのスクランブルソリューションの使用により、不正なユーザーによる盗聴を防ぐのに役立ちます。送信のシグナリングおよびユーザー識別の部分はスクランブルされません。

秘話モード対応で送信するには、無線機のチャンネルに秘話モードを設定する必要があります。ただし、秘話モードを設定していなくても受信はできます。秘話モード対応チャ

ネル上で、無線機はクリアな送信、つまりスクランブルされていない送信を引き続き受信できます。

無線機では、拡張プライバシーのみを使用できます。秘話対応の通話またはデータ送信のスクランブルを解除するには、送信側の無線機と同じスクランブル秘話モード用キー値およびキー ID を無線機にプログラムする必要があります。

無線機が別のキー値およびキー ID によるスクランブル通話を受信すると、スクランブル秘話では何も聞こえません。

無線機のプログラム方法に応じて、秘話モード対応チャンネル上で、無線機はクリアな通話、つまりスクランブルされていない通話を受信できます。さらに、無線機のプログラム方法に応じて、警告音を鳴らすことも鳴らさないこともできます。



注記:

この機能は、同じ周波数の市民バンドチャンネルでは利用できません。

無線機が送信しているとは、緑色の LED が点灯します。無線機が進行中の秘話対応通話を受信しているときは、LED が素早く点滅します。



注記:

無線機のモデルによっては、この秘話モード機能がない場合や、構成が異なる場合があります。詳細については、ディーラーまたはシステム管理者にご確認ください。



秘話モードのオンとオフの切り替え

下記の手順に従って、無線機で秘話モードのオンとオフを切り替えます。









- 1 以下のいずれか 1 つの手順を実行します。
 - プログラムされた **【ひわモード】** ボタンを押します。以下の手順をスキップします。
 - **OK** を押してメニューにアクセスします。

- 2 **▲** または **▼** を押して **【せってい】** に移動します。**OK** を押して選択します。

- 3 **▲** または **▼** を押して **【きのうせってい】** に移動します。**OK** を押して選択します。

4  または  を押して【ひわモード】に移動します。  を押して選択します。

5 以下のいずれか 1 つの手順を実行します。

-  または  を押して【オン】に移動します。  を押して選択します。ディスプレイで  が【オン】の隣に表示されます。
-  または  を押して【オフ】に移動します。  を押して選択します。ディスプレイで  が【オフ】の隣に表示されます。

応答禁止

この機能を使用すると、無線機が着信通話に応答しないようにすることができます。



注記:

これは購入可能な機能です。無線機がどのようにプログラムされているかについては、ディーラーまたはシステム管理者に確認してください。

有効にすると、無線機は着信通話に応答して送信通話を生成しません (無線機チェック、ページング、無線停止、リ

モート モニタ、自動登録サービス (ARS)、プライベート メッセージへの応答、および GNSS 位置報告の送信など)。この機能が有効になっていると、無線機は個別コールの確認を受信できません。ただし、無線機で手動による送信を行うことはできます。

応答禁止の有効化または無効化

無線機の応答禁止を有効または無効にするには、次の手順に従います。

プログラムされた【おうとうきんし】ボタンを押します。

正常に行われた場合:

- ポジティブ インジケータ トーンが鳴ります。
- ディスプレイにポジティブ ミニ通知が 1 回だけ表示されます。

正常に行われなかった場合:

- ネガティブ インジケータ トーンが鳴ります。
- ディスプレイにネガティブ ミニ通知が 1 回だけ表示されます。

機能停止/復帰

この機能では、システム内の任意の無線機の有効、無効を切り替えられます。たとえば、ディーラーやシステム管理者が、盗難にあった無線機を無効にして不正ユーザーが使用できないようにし、無線機を回収したら有効にしたい場合があります。

無線機を無効化(機能停止)または有効化(復帰)するには、コンソールを使用するか、別の無線機が開始したコマンドを使用します。

無線機が無効になると、ネガティブインジケータトーンが鳴り、ホーム画面に【チャンネルきよひ】と表示されます。

無線機が機能停止状態の場合、受信機は機能停止手順が実行されたシステムでユーザーが開始したあらゆるサービスを要求または受信できません。ただし、無線機は別のシステムに切り替えることができます。機能停止状態であっても、無線機はGNSS位置報告を送信し続けるので、リモートでモニタできます。





注記:

ディーラーやシステム管理者は、無線機を永久に無効にすることができます。詳細については、「[無線終了 ページ 186](#)」を参照してください。

無線機の機能停止

下記の手順に従って、無線機を無効にします。

1 プログラムされた **[無線停止]** ボタンを押します。

2  または  を押して必要なエリアまたは ID に移動します。  を押して選択します。ディスプレイに経過に関するミニ通知が表示され、要求が処理中であることが示されます。緑色の LED が点滅します。

3 確認応答を待ちます。

正常に行われた場合:

- ポジティブインジケータトーンが鳴ります。
- ディスプレイにポジティブミニ通知が表示されます。



正常に行われなかった場合:



- ネガティブインジケータトーンが鳴ります。
- ディスプレイにネガティブミニ通知が表示されます。



連絡先リストを使用した無線機の機能停止

下記の手順に従って、連絡先リストを使用して無線機を無効にします。

- 1  を押してメニューにアクセスします。

- 2  または  を押して『れんらくさき』に移動します。  を押して選択します。

- 3  または  を押して必要なエリアまたは ID に移動します。  を押して選択します。

- 4  または  を押して『むせんていし』に移動します。  を押して選択します。
ディスプレイに経過に関するミニ通知が表示され、要求が処理中であることが示されます。緑色の LED が点滅します。

- 5 確認応答を待ちます。

正常に行われた場合:

- ポジティブ インジケータ トーンが鳴ります。
- ディスプレイにポジティブ ミニ通知が表示されます。



正常に行われなかった場合:



- ネガティブ インジケータ トーンが鳴ります。
- ディスプレイにネガティブ ミニ通知が表示されます。



ダイヤルを使用した無線機の機能停止

下記の手順に従って、ダイヤルを使用して無線機を無効にします。

- 1  を押してメニューにアクセスします。



- 2  または  を押して『れんらくさき』に移動します。  を押して選択します。

3  または  を押して【ダイアル】に移動します。  を押して選択します。

4  または  を押して【むせんきばんごう】に移動します。  を押して選択します。

テキスト行の 1 行目に【むせん ID:】と表示されます。

5 無線機の ID を入力し、  を押して先に進みます。

6  または  を押して【むせんていし】に移動します。  を押して選択します。

ディスプレイに経過に関するミニ通知が表示され、要求が処理中であることが示されます。緑色の LED が点滅します。

7 確認応答を待ちます。

正常に行われた場合:

- ポジティブ インジケータ トーンが鳴ります。

- ディスプレイにポジティブ ミニ通知が表示されます。



正常に行われなかった場合:

- ネガティブ インジケータ トーンが鳴ります。
 - ディスプレイにネガティブ ミニ通知が表示されます。
-

無線機の復帰

下記の手順に従って、無線機を有効にします。

1 プログラムされた **【停止解除】** ボタンを押します。

2  または  を押して必要なエイリアスまたは ID に移動します。  を押して選択します。
ディスプレイに【ていしかいじょ】および無線機のエイリアスまたは ID が表示されます。緑色の LED が点灯します。

3 確認応答を待ちます。

正常に行われた場合:

- ポジティブ インジケータ トーンが鳴ります。
- ディスプレイにポジティブ ミニ通知が表示されます。



正常に行われなかった場合:



- ネガティブ インジケータ トーンが鳴ります。
- ディスプレイにネガティブ ミニ通知が表示されます。



連絡先リストを使用した無線機の復帰

下記の手順に従って、連絡先リストを使用して無線機を有効にします。

1  を押してメニューにアクセスします。

2  または  を押して【れんらくさき】に移動します。  を押して選択します。

3  または  を押して必要なエイリアスまたは ID に移動します。  を押して選択します。

4  または  を押して【ていしかいじょ】に移動します。  を押して選択します。

緑色の LED が点滅します。

ディスプレイに【ていしかいじょ】および無線機のエイリアスまたは ID が表示されます。 緑色の LED が点灯します。

5 確認応答を待ちます。

正常に行われた場合:

- トーンが鳴ります。
- ディスプレイに【ていしかいじょかんりょう】と表示されます。



正常に行われなかった場合:



- トーンが鳴ります。
- ディスプレイに【ていしかいじょしっぱい】と表示されます。



ダイヤルを使用した無線機の復帰

下記の手順に従って、ダイヤルを使用して無線機を有効にします。



- 1  を押してメニューにアクセスします。

- 2  または  を押して【れんらくさき】に移動します。  を押して選択します。

- 3  または  を押して【ダイヤル】に移動します。  を押して選択します。

- 4  または  を押して【こべつコール】に移動します。  を押して選択します。
テキスト行の 1 行目に【むせん ID:】と表示されます。

- 5 無線機の ID を入力し、  を押して先に進みます。

- 6  または  を押して【ていしかいじょ】に移動します。  を押して選択します。

緑色の LED が点滅します。

ディスプレイに【ていしかいじょ】および無線機のエイリアスまたは ID が表示されます。緑色の LED が点灯します。

- 7 確認応答を待ちます。

正常に行われた場合:

- トーンが鳴ります。
- ディスプレイに【ていしかいじょかんりょう】と表示されます。

正常に行われなかった場合:

- トーンが鳴ります。
- ディスプレイに【ていしかいじょしっぱい】と表示されます。

無線終了

この機能は、無線機への不正アクセスを制限するための拡張セキュリティ対策です。

無線終了を使用すると、無線機が操作不能になります。たとえば、盗まれた無線機や誤って配置された無線機が不正に使用されるのを防ぐために、ディーラーやシステム管理者が無線機を終了したい場合があります。

電源を入れると、終了済みの無線機の画面に一時的に「むせんしゅうりょうずみ」が表示され、終了済み状態であることが示されます。



注記:

終了済みの無線機は、Motorola Solutions のサービスステーションでのみ復帰させることができます。詳細については、ディーラーまたはシステム管理者にご確認ください。

ローンワーカー

この機能は、事前に定義された期間に、無線機のボタンの押下やチャンネルセレクトの使用などのユーザー操作がない場合に、緊急アラームを発します。

プログラムされた期間にユーザーによる操作がなく、無操作タイマーの時間が経過すると、無線機は音声インジケータでユーザーに最初の警告を発します。

事前に定義された通知タイマーの時間が経過しても確認応答がない場合、無線機はディーラーまたはシステム管理者がプログラムした緊急状況を開始します。

詳細については、「[緊急操作 ページ 134](#)」を参照してください。



注記:

詳細については、ディーラーまたはシステム管理者にご確認ください。

パスワードロック機能

本機能では、デバイスがオンになるたびにパスワードの入力を求めることによって、無線機へのアクセスを制限できます。

キーパッドマイクまたはスクロールアップ/スクロールダウン ボタンを使用して、パスワードを入力します。



パスワードを使用した無線機へのアクセス

下記の手順に従って、パスワードを使用して無線機にアクセスします。

- 1 現在の 4 桁のパスワードを入力します。

**注記:**

緊急フットスイッチを使用すると、無線機にアクセスするためのパスワード入力キャンセルされます。

- キーボードマイクを使用します。
-  または  を押して各桁の数値を編集し、 を押して値を入力し、次の桁に移動します。

2

 を押してパスワードを入力します。

- 処理が正常に行われると、無線機の電源が入ります。正常に行われなかった場合:
- 最初と 2 回目の試行の後、ディスプレイに【パスワードふてきごう】と表示されます。[ステップ 1](#) を繰り返します。
 - 3 回試行すると、ディスプレイに【パスワードふてきごう】に続き、【むせんきロックずみ】と表示されます。トーンが鳴ります。黄色の LED が 2 回点滅します。無線機は 15 分間ロック状態になります。

**注記:**

ロック状態の無線機は、**オン/オフ/音量コントロールノブ**およびプログラムされた【バックライト】ボタンからの入力にのみ反応します。

ロック状態の無線機をロック解除する

ロック状態の無線機は、コールを受信できません。下記の手順に従って、ロック状態の無線機をロック解除します。











以下のいずれか 1 つの手順を実行します。



- 無線機の電源がオンになっている場合には、15 分待つてから [パスワードを使用した無線機へのアクセス ページ 186](#) の手順を繰り返し、無線機にアクセスします。
- 無線機の電源がオフになっている場合には、無線機の電源をオンにします。ロック状態の 15 分タイマーが再起動されます。トーンが鳴ります。黄色の LED が 2 回点滅します。ディスプレイに【むせんきロックずみ】と表示されます。









15分待ってから **パスワードを使用した無線機へのアクセス ページ 186** の手順を繰り返し、無線機にアクセスします。

パスワードロックのオンとオフの切り替え

下記の手順に従って、無線機でパスワードロックのオンとオフを切り替えます。

- 1  を押してメニューにアクセスします。
- 2  または  を押して【せってい】に移動します。  を押して選択します。
- 3  または  を押して【きのうせってい】に移動します。  を押して選択します。
- 4  または  を押して【パスワード ロック】に移動します。  を押して選択します。
- 5 現在の4桁のパスワードを入力します。











- キーパッド マイクを使用します。
-  または  を押して各桁の数値を編集し、  を押して値を入力し、次の桁に移動します。数値を押すたびに、ポジティブインジケータ トーンが鳴ります。

- 6  を押してパスワードを入力します。
パスワードが正しくない場合は、ディスプレイに【パスワードふてきごう】と表示され、自動的に前のメニューへ戻ります。
- 7 以下のいずれか1つの手順を実行します。
 -  または  を押して【オン】に移動します。  を押して選択します。ディスプレイの【オン】の隣に  が表示されます。
 -  または  を押して【オフ】に移動します。  を押して選択します。





ディスプレイの【オフ】の隣に ✓ が表示されます。

パスワードの変更

下記の手順に従って、無線機でパスワードを変更します。

- 1  を押してメニューにアクセスします。
- 2  または  を押して【せってい】に移動します。 を押して選択します。
- 3  または  を押して【きのうせってい】に移動します。 を押して選択します。
- 4  または  を押して【パスワード ロック】に移動します。 を押して選択します。
- 5 現在の 4 桁のパスワードを入力し、 を押して次に進みます。

パスワードが正しくない場合は、ディスプレイに【パスワードふてきごう】と表示され、自動的に前のメニューへ戻ります。

- 6  または  を押して【パスワード ヘンコウ】に移動します。 を押して選択します。
 - 7 新しい 4 桁のパスワードを入力し、 を押して次に進みます。
 - 8 新しい 4 桁のパスワードをもう一度入力し、 を押して次に進みます。
処理が正常に行われると、ディスプレイに【パスワードへんこうずみ】と表示されます。
処理が正常に行われなかった場合は、ディスプレイに【パスワードふてきごう】と表示されます。
前のメニューに自動的に戻ります。
-

通知リスト

無線機には、未読のメッセージ、テレメータメッセージ、不在着信やページングなど、チャンネル上で未読のイベントをすべて収集する通知リストがあります。

通知リストにイベントが1件以上あると、ディスプレイに**【おしらせ】**アイコンが表示されます。



リストでは、最大**40**の未読イベントを使用できます。リストがいっぱいになると、自動的に最も古いイベントが次のイベントで置き換えられます。これらのイベントは、読まれた後、通知リストから削除されます。



テキストメッセージ、不在着信、およびページングイベントの場合、通知の最大数は、テキストメッセージで**30**件、不在着信またはページングで**10**件です。この最大数は、個々の機能(JOB チケット、テキストメッセージ、不在着信、またはページング)のリスト容量に応じて異なります。

通知リストへのアクセス

下記の手順に従って、無線機で通知リストにアクセスします。

- 1  を押してメニューにアクセスします。

- 2  または  を押して**【おしらせ】**に移動します。  を押して選択します。

- 3  または  を押して必要なイベントに移動します。  を押して選択します。

ホーム画面に戻るには、  を長押しします。

エア接続プログラミング

ディーラーは、エア接続プログラミング (OTAP) を使用して、物理的に接続することなく、無線機をリモートから更新できます。さらに、一部の設定も OTAP から設定できます。

無線機が OTAP を実行中のときは、緑色の LED が点滅します。

大量データを受信した場合:

- ディ스플레이に**【大量データ】**アイコンが表示されます。
- チャンネルがビジー状態になります。
- **PTT** ボタンを押すと、ネガティブトーンが鳴ります。

OTAP が完了した場合 (構成に依存):

- トーンが鳴ります。ディスプレイに【アップデート リセット】と表示されます。電源がオフになってからオンになり、無線機が再起動します。
- 【リスタート】または【えんきする】を選択できます。【えんきする】を選択すると、前の画面に戻ります。自動再起動が行われるまで、ディスプレイに【OTAP 遅延タイマー】アイコンが表示されます。

自動再起動後に無線機の電源が入った場合:

- 成功すると、ディスプレイに【ソフト アップデートかんりょう】と表示されます。
- 失敗すると、ディスプレイに【ソフト アップデートしつぱい】と表示されます。

更新されたソフトウェアバージョンについては、「[ソフトウェア更新情報のチェック ページ 224](#)」を参照してください。



サードパーティ周辺機器接続モードの選択



下記の手順に従って、以下のいずれかのサードパーティ周辺機器接続モードを選択します。



- **Motorola Solutions**
- **PC とオーディオ**



- データ アクセサリ
- テレメータ
- ジェネリック

1  を押してメニューにアクセスします。

2  または  を押して【せってい】に移動します。  を押して選択します。

3  または  を押して【きのうせってい】に移動します。  を押して選択します。

4  または  を押して、【ケーブル タイプ】に移動します。  を押して選択します。

5  または  を押して必要な接続モードに移動します。  を押して選択します。
ディスプレイには選択された接続モードが表示されます。画面は前のメニューに戻ります。



受信信号強度インジケータ

この機能を使用して、受信信号強度インジケータ (RSSI) 値を表示できます。

ディスプレイでは、[RSSI] アイコンが右上端に表示されません。[RSSI] アイコンの詳細については、「[ディスプレイアイコン](#)」を参照してください。

RSSI 値の表示

4 ウェイ ナビゲーション キーパッド マイク (Motorola Solutions 部品番号 RMN5127_) を無線機に取り付けます。

ホーム画面で、4 ウェイ ナビゲーション キーパッド マイクを使用して、 を 3 回押し、すぐに  を 3 回押します。

ディスプレイに現在の RSSI 値が表示されます。

ホーム画面に戻るには、 を長押しします。







正面パネル設定

正面パネル設定 (FPC) の特定の機能パラメータをカスタマイズして無線機を効果的に利用できます。

正面パネル設定モードの開始



下記の手順に従って、無線機で正面パネル プログラミング モードに入ります。



 を長く押しすと、いつでもホーム画面に戻ります。

- 1  を押してメニューにアクセスします。
- 2  または  を押して [せってい] に移動します。  を押して選択します。
- 3  または  を押して [PGM Radio] に移動します。  を押して選択します。

FPP モード パラメータの編集

機能パラメータをナビゲートするときに必要に応じて次のボタンを使用します。

-   、 - オプションをスクロールしたり、値を増減したり、垂直にナビゲートしたりします。

-  – オプションを選択するか、サブメニューを入力します。
-  – 短押しすると、前のメニューに戻るか、選択画面を終了することができます。長押しすると、ホーム画面に戻ります。

Wi-Fi 操作

この機能で、Wi-Fi ネットワークをセットアップして接続できます。Wi-Fi は、無線機のファームウェア、コードプラグ、言語パックや音声ガイドなどのリソースの更新をサポートします。



注記:

この機能が適用されるモデルは、XiR M8668i/CM7668i のみです。

Wi-Fi® は Wi-Fi Alliance® の登録商標です。

お使いの無線機は、WEP/WPA/WPA2 パーソナル Wi-Fi および WPA/WPA2 エンタープライズ Wi-Fi のネットワークに対応しています。

WEP/WPA/WPA2 パーソナル Wi-Fi ネットワーク

事前共有キー (パスワード) ベースの認証を使用します。

事前共有キーは、メニューまたは CPS/RM を使用して入力できます。

WPA/WPA2 エンタープライズ Wi-Fi ネットワーク

証明書ベースの認証を使用します。

無線機を証明書使って事前設定しておく必要があります。



注記:

WPA/WPA2 エンタープライズ Wi-Fi ネットワークへの接続については、ディーラーまたはシステム管理者に確認してください。

プログラムされた **[Wi-Fi オン/オフ]** ボタンがディーラーまたはシステム管理者により割り当てられます。無線機がどのようにプログラムされているかについては、ディーラーまたはシステム管理者に確認してください。

プログラムされた **[Wi-Fi オン/オフ]** ボタンの音声ガイドは、ユーザーの要件に応じて、CPS を使用してカスタマイズできます。詳細については、ディーラーまたはシステム管理者にご確認ください。



注記:

スーパーバイザ無線機を使用して、リモートで Wi-Fi をオンまたはオフにできます ([スーパーバイザ無線機を使用して Wi-Fi のオン/オフを切り替える](#) を参照)。詳細については、ディーラーまたはシステム管理者にご確認ください。



Wi-Fi のオン/オフの切り替え



下記の手順に従って、Wi-Fi のオンとオフを切り替えます。

- 1 プログラムされた **[Wi-Fi オン/オフ]** ボタンを押します。Wi-Fi のオンまたは Wi-Fi のオフの音声ガイドが聴こえます。

- 2 メニューを使用してこの機能にアクセスします。

a  を押してメニューにアクセスします を押します。

b  または  を押して **[Wi-Fi]** に移動し、
 を押して選択します。

c  または  を押して **[Wi-Fi オン]** に移動し、
 を押して選択します。

d  を押して、Wi-Fi をオン/オフにします。

Wi-Fi がオンの場合、ディスプレイで **[ゆうこう]** の隣に  が表示されます。

Wi-Fi がオフの場合は、**[ゆうこう]** の隣から  が消えます。



指定された無線機を使用してリモートで Wi-Fi をオンまたはオフにする (個別制御)



下記の手順に従って、個別制御 (1 対 1) でリモートで Wi-Fi のオン/オフを切り替えます。







注記:

特定の CPS 設定を持つ無線機のみがこの機能をサポートします。詳細については、ディーラーまたはシステム管理者にご確認ください。

- 1 以下のいずれか 1 つの手順を実行します。
 - プログラム可能ボタンを長押しします。キーパッドを使用して **ID** と  を押して選択しますを入力します。ステップ 3 に進みます。
 -  を押してメニューにアクセスします を押します。

2  または  を押して【れんらくさき】に移動し、 を押して選択します。

3  または  を押して、【WiFi せいぎよ】にアクセスし、 を押して選択します。

4  または  を押して【オン】または【オフ】を選択します。

5  を押して選択します。

成功すると、ディスプレイにポジティブ ミニ通知が表示されます。

失敗すると、ディスプレイにネガティブ ミニ通知が表示されます。

指定された無線機を使用してリモートで Wi-Fi をオンまたはオフにする (グループコントロール)



下記の手順に従って、グループコントロール (1 対多) でリモートで Wi-Fi のオン/オフを切り替えます。







注記:



特定の CPS 設定を持つ無線機のみがこの機能をサポートします。詳細については、ディーラーまたはシステム管理者にご確認ください。

1  を押してメニューにアクセスします を押します。

2  または  を押して【れんらくさき】に移動し、 を押して選択します。

3  または  を押して必要な無線機のエリアスまたは ID を選択します。

4  または  を押して、【WiFi せいぎよ】にアクセスし、 を押して選択します。

5  または  を押して【オン】または【オフ】を選択します。

- 6  を押して選択します。

処理が正常に行われると、ディスプレイに『せいじょうにそうしん』と表示されます。

失敗すると、ディスプレイにネガティブミニ通知が表示されます。

ネットワーク アクセス ポイントへの接続

Wi-Fi をオンにすると、無線がネットワーク アクセス ポイントに接続します。









注記:



また、メニューからもネットワーク アクセス ポイントに接続できます。

WPA エンタープライズ Wi-Fi ネットワークのアクセス ポイントは、事前に設定されています。無線機がどのようにプログラムされているかについては、ディーラーまたはシステム管理者に確認してください。

- 1  を押してメニューにアクセスします を押します。

- 2  または  を押して [Wi-Fi] に移動し、
 を押して選択します。



- 3  または  を押して [ネットワーク] に移動して、
 を押して選択します。

- 4  または  を押してネットワーク アクセス ポイントに移動し、
 を押して選択します。



注記:

WPA エンタープライズ Wi-Fi で、ネットワーク アクセス ポイントが事前に設定されていない場合、『せつぞく』オプションは使用できません。

- 5  または  を押して [せつぞく] に移動し、
 を押して選択します。

- 6 WPA パーソナル Wi-Fi の場合、パスワードを入力して
 を押します。

7 WPA エンタープライズ Wi-Fi の場合、パスワードは RM を使用して設定されます。

事前に設定されているパスワードが正しい場合、無線機は自動的に選択したネットワーク アクセス ポイントに接続します。

事前に設定したパスワードが正しくない場合、ディスプレイに【にんしょうエラー】と表示され、自動的に前のメニューへ戻ります。

接続に成功すると、無線に通知が表示され、ネットワーク アクセス ポイントがプロファイルリストに保存されます。

接続に失敗すると、無線のディスプレイに失敗通知画面が瞬時的に表示され、自動的に前のメニューへ戻ります。

Wi-Fi 接続ステータスの確認

下記の手順に従って、Wi-Fi 接続のステータスを確認します。

プログラムされた **[Wi-Fi ステータス照会]** ボタンを押し、音声ガイドで接続ステータスを確認します。Wi-Fi がオフ、

Wi-Fi がオンで接続なし、または Wi-Fi がオンで接続ありの音声ガイドが流れます。

- Wi-Fi がオフになっていると、ディスプレイに【Wi-Fi オフ】と表示されます。
- 無線機がネットワークに接続されていると、ディスプレイに【Wi-Fi オン】、【接続済み】と表示されます。
- Wi-Fi がオンになっているが、無線機がネットワークに接続されていない場合、【Wi-Fi オン】、【切断済み】と表示されます。

Wi-Fi ステータス照会結果の音声ガイドは、ユーザーの要件に応じて、CPS を使用してカスタマイズできます。詳細については、ディーラーまたはシステム管理者にご確認ください。













注記:

プログラムされた **[Wi-Fi ステータス照会]** ボタンがディーラーまたはシステム管理者によって割り当てられます。無線機がどのようにプログラムされているかについては、ディーラーまたはシステム管理者に確認してください。

ネットワーク リストの更新

下記の手順に従って、ネットワーク リストを更新します。

- メニューからネットワーク リストを更新するには、次の操作を実行します。
 - a.  を押してメニューにアクセスします を押します。
 - b.  または  を押して【WiFi】に移動し、
 を押して選択します。
 - c.  または  を押して【ネットワーク】に移動して、
 を押して選択します。
【ネットワーク】メニューに移動すると、ネットワーク リストが自動的に更新されます。
- 【ネットワーク】メニューをすでに移動している場合は、次の操作を実行してネットワーク リストを更新します。

 または  を押して【こうしん】に移動し、
 を押して選択します。

ネットワーク リストが更新され、最新のリストが表示されます。

ネットワークの追加









注記:



このタスクは、WPA エンタープライズ Wi-Fi ネットワークには適用されません。

使用可能なネットワークのリストに優先ネットワークがない場合は、次の操作を実行してネットワークを追加します。



- 1  を押してメニューにアクセスします を押します。

- 2  または  を押して【WiFi】に移動し、
 を押して選択します。

- 3  または  を押して【ネットワーク】に移動して、
 を押して選択します。

- 4  または  を押して [ネットワーク つか] に移動し、  を押して選択します。

- 5 サービス セット 識別子 (SSID) を入力して、  を押します。



- 6  または  を押して [ひらく] に移動し、  を押して選択します。



- 7 パスワードを入力して、  を押します。
無線機にポジティブ ミニ通知が表示され、ネットワークが正常に保存されたことが示されます。



ネットワーク アクセス ポイントの詳細の表示



ネットワーク アクセス ポイントの詳細を表示できます。

- 1  を押してメニューにアクセスします を押します。

- 2  または  を押して [WiFi] に移動し、  を押して選択します。

- 3  または  を押して [ネットワーク] に移動して、  を押して選択します。

- 4  または  を押してネットワーク アクセス ポイントに移動し、  を押して選択します。

- 5  または  を押して [しようさい] に移動し、  を押して選択します。



注記:

通常の WPA パーソナル Wi-Fi と WPA エンタープライズ Wi-Fi では、表示されるネットワーク アクセス ポイントの詳細は異なります。

WPA パーソナル Wi-Fi

接続済みのネットワーク アクセス ポイントについては、サービス セット 識別子 (SSID)、セキュリティ モード、メディア アクセス 制御 (MAC) アドレス、およびイ

インターネット プロトコル (IP) アドレスが無線機に表示されます。

接続されていないネットワーク アクセス ポイントについては、**SSID** およびセキュリティ モードが無線機に表示されます。

WPA エンタープライズ Wi-Fi

接続済みのネットワーク アクセス ポイントについては、**SSID**、セキュリティ モード、**ID**、拡張認証プロトコル (EAP) 方式、フェーズ 2 認証、証明書名、**MAC** アドレス、**IP** アドレス、ゲートウェイ、**DNS1**、および **DNS2** が無線機に表示されます。

接続されていないネットワーク アクセス ポイントについては、**SSID**、セキュリティ モード、**ID**、**EAP** 方式、フェーズ 2 認証、および証明書名が無線機に表示されます。



ネットワーク アクセス ポイントの削除









注記:



このタスクは、エンタープライズ Wi-Fi ネットワークには適用されません。



プロファイル リストのネットワーク アクセス ポイントを削除するには、次の操作を実行します。



- 1  を押してメニューにアクセスします。  を押しません。

- 2  または  を押して [WiFi] に移動し、 を押して選択します。

- 3  または  を押して [ネットワーク] に移動して、 を押して選択します。

- 4  または  を押して、選択したネットワーク アクセス ポイントに移動し、 を押して選択します。

- 5  または  を押して [さくじょ] に移動し、 を押して選択します。

- 6  または  を押して [はい] に移動し、 を押して選択します。

無線機にポジティブ ミニ通知が表示され、選択したネットワーク アクセス ポイントが正常に削除されたことが示されます。

- トーンが鳴ります。
- ホーム画面に戻る前に、ディスプレイに一時的に [<DGNA グループ エイリアス> 削除済み] と表示されます。
- ステータス バーから DGNA アイコンが消えます。
- ホーム画面に、前のグループ エイリアスが表示されません。

無線機のプログラムに応じて、元のスキャン リスト チャンネルと DGNA 以外のグループを表示、編集、および聞き取ることができます。

無線機が DGNA モードになっている場合、[PTT] ボタンを押すと、現在の DGNA グループとのみ通信できます。以前の DGNA 以外のグループと通信するには、[ワンタッチ アクセス] ボタンをプログラムします。「[DGNA 以外の通話の発信 ページ 202](#)」を参照してください。



注記:

無線機がどのようにプログラムされているかについては、ディーラーまたはシステム管理者に確認してください。

動的グループ番号割当 (DGNA)

動的グループ番号割当 (DGNA) は、コンソールが無線で無線機に新しいグループを割り当てたり削除したりできる機能です。

コンソールが DGNA を無線機に割り当てると、無線機は DGNA モードになります。

- トーンが鳴ります。
- ホーム画面に戻る前に、ディスプレイに一時的に [<DGNA グループ エイリアス> 割り当て済み] と表示されます。
- DGNA アイコンがステータス バーに表示されます。
- ホーム画面に DGNA グループ エイリアスが表示されません。

コンソールが無線機から DGNA を削除すると、無線機は前のグループに戻ります。

DGNA コールの発信

無線機が DGNA モードになっている場合、**[PTT]** ボタンを押して通話を発信します。

- DGNA トーンが鳴ります。
- ディスプレイに DGNA アイコンと DGNA グループ エイリアスが表示されます。



注記:

無線機が DGNA モードではない場合に **[ワンタッチ アクセス]** ボタンを押すと、無線機からトーンが鳴り、エラーを示します。表示は変わりません。



注記:

無線機が DGNA モードではない場合に **[ワンタッチ アクセス]** ボタンを押すと、無線機からネガティブトーンが鳴り、エラーを示します。表示は変わりません。

- 2 ネガティブトーンが鳴る前に **[PTT]** ボタンを押すと、無線機がホーム画面に戻ります。



注記:

無線機にホーム画面が表示されている場合、**[PTT]** を押すと DGNA グループへ通話を発信します。

DGNA 以外の通話の発信

- 1 プログラムされた **[ワンタッチ アクセス]** ボタンを押します。
 - ポジティブトーンが鳴ります。
 - ワンタッチ上書き通話の音声ガイドが流れます。
 - ディスプレイに **【<グループ エイリアス> および [PTT を押す]** と瞬間的に表示されます。

DGNA 通話の受信と応答

DGNA コールを受信した場合:

- DGNA トーンが鳴ります。
- ディスプレイに、DGNA アイコン、DGNA グループ エイリアス、および無線機エイリアスが表示されます。
- 無線機のミュートが解除され、着信通話の音はスピーカから聞こえます。

- 1 電話に応答するには、**[PTT]** ボタンを押します。

- 2 相手の声を聞くには、**PTT** ボタンを放します。

ユーティリティ

この章では、無線機で使用できるユーティリティ機能の操作について説明します。

出力レベル

各チャネルの出力設定の高低をカスタマイズできます。

つよめ

この設定では、かなり離れた場所にある無線機とも交信できるようになります。

少ない

この設定では、近い場所にある無線機と交信できます。



注記:



この機能は、同じ周波数の市民バンドチャネルには適用されません。



出力レベルの設定



下記の手順に従って、無線機で出力レベルを設定します。

- 1 以下のいずれか 1 つの手順を実行します。





- プログラムされた **[出力レベル]** ボタンを押します。以下の手順をスキップします。
-  を押してメニューにアクセスします。





- 2  または  を押して **[せってい]** に移動します。  を押して選択します。

- 3  または  を押して **[きのうせってい]** に移動します。  を押して選択します。

- 4  または  を押して **[でんげん]** に移動します。  を押して選択します。

- 5 以下のいずれか 1 つの手順を実行します。

-  または  を押して **[■■■■■]** に移動します。  を押して選択します。ディスプレイの **[■■■■■]** の隣に  が表示されます。



-  または  を押して **【■■■■■】** に移動します。 を押して選択します。
 ディスプレイの **【■■■■■】** の隣に  が表示されます。



- 6 ホーム画面に戻るには、 を長押しします。



無線機トーン/アラートのオンとオフの切り替え



着信緊急警告トーン以外の、すべての無線機トーンやアラートは、必要に応じて有効化および無効化できます。下記の手順に従って、無線機でトーン/アラートのオンとオフを切り替えます。



- 以下のいずれか 1 つの手順を実行します。
 - プログラムされた **【トーン/アラート】** ボタンを押します。以下の手順をスキップします。
 -  を押してメニューにアクセスします。

-  または  を押して **【せってい】** に移動します。 を押して選択します。

-  または  を押して **【きのうせってい】** に移動します。 を押して選択します。

-  または  を押して **【トーン/アラート】** に移動します。 を押して選択します。



-  または  を押して **【ぜん トーン】** に移動します。 を押して選択します。



-  を押して、すべてのトーンおよびアラートを無効または有効にします。ディスプレイに次のいずれかの結果が表示されます。
 - 有効にすると、 が **【ゆうこう】** の隣に表示されます。
 - 無効な場合、 が **【ゆうこう】** の隣で非表示になります。



キー操作音のオンとオフの切り替え



下記の手順に従って、無線機でキー操作音のオンとオフを切り替えます。

- 1  を押してメニューにアクセスします。

- 2  または  を押して【せってい】に移動します。  を押して選択します。

- 3  または  を押して【きのうせってい】に移動します。  を押して選択します。

- 4  または  を押して【トーン/アラート】に移動します。  を押して選択します。



- 5  または  を押して【キーそうさおん】に移動します。  を押して選択します。



- 6  を押してキー操作音を有効または無効にします。ディスプレイに次のいずれかの結果が表示されます。
 - 有効にすると、✓が【ゆうこう】の隣に表示されます。
 - 無効な場合、✓が【ゆうこう】の隣で非表示になります。



トーン/アラートのボリューム オフセット レベルの設定





この機能は、音声ボリュームを基準としてトーンまたはアラートのボリュームを調節できます。下記の手順に従って、無線機でトーンとアラートのボリューム オフセット レベルを設定します。



- 1  を押してメニューにアクセスします。

- 2  または  を押して【せってい】に移動します。  を押して選択します。



3  または  を押して【きのうせってい】に移動します。  を押して選択します。

4  または  を押して【トーン/アラート】に移動します。  を押して選択します。

5  または  を押して【 オフセット】に移動します。  を押して選択します。

6  または  を押して必要なボリューム オフセット レベルに移動します。
対応する各ボリューム オフセット レベルのフィードバック トーンが鳴ります。



7 以下のいずれか 1 つの手順を実行します。



-  を押して選択します。必要な音量オフセットレベルが保存されます。
 -  を押して終了します。変更が破棄されず。
-



通話許可トーンのオンとオフの切り替え



下記の手順に従って、無線機で通話許可トーンのオンとオフを切り替えます。

1  を押してメニューにアクセスします。

2  または  を押して【せってい】に移動します。  を押して選択します。

3  または  を押して【きのうせってい】に移動します。  を押して選択します。

4  または  を押して【トーン/アラート】に移動します。  を押して選択します。

5  または  を押して【きよか トーン】に移動します。  を押して選択します。

- 6  を押して通話許可トーンを有効または無効にします。



ディスプレイに次のいずれかの結果が表示されます。



- 有効にすると、✓が【ゆうこう】の隣に表示されます。
- 無効な場合、✓が【ゆうこう】の隣で非表示になります。



パワーアップトーンのオンとオフの切り替え



下記の手順に従って、無線機でパワーアップトーンのオンとオフを切り替えます。

- 1  を押してメニューにアクセスします。

- 2  または  を押して【せってい】に移動します。  を押して選択します。

- 3  または  を押して【きのうせってい】に移動します。  を押して選択します。

- 4  または  を押して【トーン/アラート】に移動します。  を押して選択します。

- 5  または  を押して【でんげんオン】に移動します。  を押して選択します。















- 6  を押してパワーアップトーンを有効または無効にします。ディスプレイに次のいずれかの結果が表示されます。





- 有効にすると、✓が【ゆうこう】の隣に表示されます。
- 無効な場合、✓が【ゆうこう】の隣で非表示になります。

メッセージアラームトーンの設定

連絡先リストの各エントリに対して、メッセージアラームトーンを【1かいのみ】または【くりかえし】にカスタマイズ





できます。下記の手順に従って、無線機でメッセージアラーム トーンを設定します。

- 1  を押してメニューにアクセスします。
- 2  または  を押して「れんらくさき」に移動します。  を押して選択します。
- 3  または  を押して必要なエリアまたは ID に移動します。  を押して選択します。
- 4  または  を押して「メッセージ アラーム」に移動します。  を押して選択します。
- 5 以下のいずれか 1 つの手順を実行します。
 -  または  を押して「1 かいのみ」に移動します。  を押して選択します。ディスプレイの「1 かいのみ」の隣に  が表示されます。

-  または  を押して「くりかえし」に移動します。  を押して選択します。ディスプレイの「くりかえし」の隣に  が表示されます。

表示モードの変更

必要に応じて、無線機の表示モードをデイとナイトの間で切り替えられます。この機能により、ディスプレイの色パレットが影響を受けます。下記の手順に従って、無線機の表示モードを変更します。

- 1 以下のいずれか 1 つの手順を実行します。
 - プログラムされた**表示モード** ボタンを押します。以下の手順をスキップします。
 -  を押してメニューにアクセスします。
- 2  または  を押して「せってい」に移動します。  を押して選択します。

3 ▲ または ▼ を押して【きのうせってい】に移動します。 OK を押して選択します。

4 ▲ または ▼ を押して【ひょうじ】に移動します。 OK を押して選択します。

ディスプレイに【デイモード】と【ナイトモード】が表示されます。

5 ▲ または ▼ を押して必要な設定に移動します。 OK を押して選択します。
選択した設定の横に ✓ が表示されます。

表示輝度の調整

下記の手順に従って、無線機の表示輝度を調整します。【あかるさじどう】が有効の場合、表示輝度は調整できません。

- 以下のいずれか 1 つの手順を実行します。
 - プログラムされた【輝度】ボタンを押します。以下の手順をスキップします。

- OK を押してメニューにアクセスします。
-

2 ▲ または ▼ を押して【せってい】に移動します。 OK を押して選択します。

3 ▲ または ▼ を押して【きのうせってい】に移動します。 OK を押して選択します。



4 ▲ または ▼ を押して【きど】に移動します。 OK を押して選択します。
ディスプレイに進行状況バーが表示されます。



5 ▲ または ▼ を押して表示輝度を増減します。 OK を押して選択します。
設定値は 1 から 8 まで変わります。



ホーンとライトのオンとオフの切り替え



無線機では、着信通話をホーンとライトで知らせることができます。この機能を有効にすると、着信通話があるたびに車両のホーンが鳴り、車両のライトが点灯します。この機能は、ディーラーが無線機の背面アクセサリコネクタからインストールする必要があります。下記の手順に従って、無線機で全ホーンとライトのオン、オフを切り替えます。

- 以下のいずれか 1 つの手順を実行します。
 - プログラムされた **[ホーン/ライト]** ボタンを押します。以下の手順をスキップします。
 -  を押してメニューにアクセスします。

-  または  を押して **[せってい]** に移動します。 を押して選択します。

-  または  を押して **[きのうせってい]** に移動します。 を押して選択します。



-  または  を押して **[ホーン/ライト]** に移動します。 を押して選択します。



-  を押して **[ホーン/ライト]** を有効または無効にします。ディスプレイに次のいずれかの結果が表示されます。
 - 有効にすると、 が **[ゆうこう]** の隣に表示されます。
 - 無効な場合、 が **[ゆうこう]** の隣で非表示になります。



LED インジケータのオンとオフの切り替え

下記の手順に従って、無線機で LED インジケータのオンとオフを切り替えます。

-  を押してメニューにアクセスします。

-  または  を押して **[せってい]** に移動します。 を押して選択します。

3  または  を押して【きのうせってい】に移動します。  を押して選択します。

4  または  を押して【LED ひょうじ】に移動します。  を押して選択します。

5  を押して LED 表示を有効または無効にします。

ディスプレイに次のいずれかの結果が表示されません。



- 有効にすると、✓が【ゆうこう】の隣に表示されます。
 - 無効な場合、✓が【ゆうこう】の隣で非表示になります。
-



パブリックアドレス システムのオンとオフの切り替え



下記の手順に従って、無線機の内部パブリックアドレス (PA) システムを有効または無効にします。

1 以下のいずれか 1 つの手順を実行します。

- プログラムされた【パブリックアドレス】ボタンを押します。以下の手順をスキップします。
 -  を押してメニューにアクセスします。
-

2  または  を押して【せってい】に移動します。  を押して選択します。

3  または  を押して【きのうせってい】に移動します。  を押して選択します。

4  または  を押して【パブリックアドレス】に移動します。  を押して選択します。

5  を押してパブリックアドレスを有効または無効にします。



- 有効にすると、✓が【ゆうこう】の隣に表示されます。



- 無効な場合、✓が【ゆうこう】の隣で非表示になります。



外部パブリックアドレスシステムのオンとオフの切り替え

下記の手順に従って、無線機の外部パブリックアドレス (PA) システムを有効または無効にします。

- 以下のいずれか 1 つの手順を実行します。
 - プログラムされた【外部パブリックアドレス】ボタンを押します。以下の手順をスキップします。
 -  を押してメニューにアクセスします。

-
-  または  を押して【せってい】に移動します。 を押して選択します。

-
-  または  を押して【きのうせってい】に移動します。 を押して選択します。



-
-  または  を押して【外部パブリック アドレス】に移動します。 を押して選択します。



-
-  を押して外部パブリックアドレスを有効または無効にします。
 - 有効にすると、✓が【ゆうこう】の隣に表示されます。
 - 無効な場合、✓が【ゆうこう】の隣で非表示になります。



初期画面のオンとオフの切り替え



手順に従って、初期画面の有効、無効を切り替えることができます。

-
-  を押してメニューにアクセスします。

-
-  または  を押して【せってい】に移動します。 を押して選択します。



3  または  を押して【きのうせってい】に移動します。  を押して選択します。

4  または  を押して【ひょうじ】に移動します。  を押して選択します。

5  または  を押して【しよきがめん】に移動します。  を押して選択します。

6  を押して【しよきがめん】を有効または無効にします。



ディスプレイに次のいずれかの結果が表示されません。



- 有効にすると、 が【ゆうこう】の隣に表示されます。
 - 無効な場合、 が【ゆうこう】の隣で非表示になります。
-



言語の設定



下記の手順に従って、無線機で言語を設定します。

1  を押してメニューにアクセスします。

2  または  を押して【せってい】に移動します。  を押して選択します。

3  または  を押して【きのうせってい】に移動します。  を押して選択します。

4  または  を押して【げんご】に移動します。  を押して選択します。



5  または  を押して必要な言語に移動します。  を押して選択します。



選択した言語の横に  が表示されます。



ケーブル タイプの特定

下記の手順に従って、無線機で使用するケーブルのタイプを選択します。

- 1  を押してメニューにアクセスします。

- 2  または  を押して【せってい】に移動します。  を押して選択します。

- 3  または  を押して【きのうせってい】に移動します。  を押して選択します。

- 4  または  を押して、【ケーブル タイプ】に移動します。  を押して選択します。

- 5 現在のケーブル タイプは  で示されます。

音声ガイドのオンとオフの切り替え

この機能をオンにすると、ユーザーがゾーンとチャンネルを割り当てたときや、ユーザーがプログラム可能ボタンを押したときに、その内容を音声で知らせます。ディスプレイに表示されているコンテンツの読み取りが困難な状況で役立ちます。

この音声インジケータは、お客様の要件に応じてカスタマイズできます。下記の手順に従って、無線機で音声ガイドのオンとオフを切り替えます。

オプション ボードのオンとオフの切り替え

各チャンネル内のオプション ボード機能をプログラム可能なボタンに割り当てることができます。1つのチャンネルは、最大6のオプション ボード機能をサポートします。下記の手順に従って、無線機でオプション ボードのオンとオフを切り替えます。

プログラムされた【オプション ボード】ボタンを押します。

音声変換

音声変換機能は、ディーラーまたはシステム管理者のみが有効にできます。音声変換が有効になっている場合、音声ガイド機能は自動的に無効になります。音声ガイドが有効になっている場合、音声変換機能が自動的に無効になります。

この機能では、次の機能を音声で知らせることができます。



- 現在のチャンネル
- 現在のゾーン
- プログラムされたボタン機能のオン/オフ
- 受信済みテキスト メッセージの内容
- 受信済み JOB チケットの内容



この音声インジケータは、お客様の要件に応じてカスタマイズできます。本機能は、ディスプレイに表示されているコンテンツの読み取りが困難な状況で役立ちます。



音声変換の設定



下記の手順に従って、音声変換機能を設定します。

- 1  を押してメニューにアクセスします。

- 2  または  を押して【せってい】に移動します。  を押して選択します。

- 3  または  を押して【きのうせってい】に移動します。  を押して選択します。

- 4  または  を押して【おんせいガイド】に移動します。  を押して選択します。

- 5  または  を押して以下の機能のいずれかに移動します。  を押して選択します。











利用可能な機能は以下の通りです。



- すべて
- メッセージ
- JOB チケット
- チャンネル
- ゾーン



- プログラム ボタン
- ✓ 選択した設定の隣に  が表示されます。

カメラ メニュー タイマー

ホーム画面に自動的に切り替わるまでメニューが表示され続ける時間を設定できます。下記の手順に従って、メニュー タイマーを設定します。





- 1  を押してメニューにアクセスします。
- 2  または  を押して【せってい】に移動します。  を押して選択します。
- 3  または  を押して【きのうせってい】に移動します。  を押して選択します。
- 4  または  を押して【ひょうじ】に移動します。  を押して選択します。



- 5  または  を押して【タイマー メニュー】に移動します。  を押して選択します。



- 6  または  を押して必要な設定に移動します。  を押して選択します。

デジタルマイク AGC のオンとオフの切り替え

デジタルマイク自動ゲイン制御 (AGC) を使用すると、デジタルシステム上で送信するとき、無線機のマイクゲインを自動的に制御できます。この機能は、大きい音が出ないようにしたり小さい音をプリセット値まで増幅したりして、音声レベルを一定に保ちます。下記の手順に従って、無線機でデジタルマイク AGC のオンとオフを切り替えます。

- 1  を押してメニューにアクセスします。
- 2  または  を押して【せってい】に移動します。  を押して選択します。

3  または  を押して【きのうせってい】に移動します。  を押して選択します。

4  または  を押して【Mic AGC-D】に移動します。  を押して選択します。

5  を押して、デジタルマイク AGC を有効化/無効化します。

ディスプレイに次のいずれかの結果が表示されます。

- 有効にすると、✓が【ゆうこう】の隣に表示されます。
 - 無効な場合、✓が【ゆうこう】の隣で非表示になります。
-

インテリジェント オーディオのオンとオフの切り替え







定常騒音源と非定常騒音源の両方を含む、周辺環境の背景雑音が大きいの場合、それに負けないように音量を自動的に



調整します。これは受信側の限定機能であり、送信音声は影響を受けません。下記の手順に従って、無線機でインテリジェント オーディオのオンとオフを切り替えます。











注記:

この機能は、Bluetooth セッションでは使用できません。

- 1 以下のいずれか 1 つの手順を実行します。
 - プログラムされた【インテリジェント オーディオ】ボタンを押します。以下の手順をスキップします。
 -  を押してメニューにアクセスします。
 - 2  または  を押して【せってい】に移動します。  を押して選択します。
 - 3  または  を押して【きのうせってい】に移動します。  を押して選択します。
-



4  または  を押して [Int オーディオ] に移動します。  を押して選択します。



5 以下のいずれか 1 つの手順を実行します。



-  または  を押して [オン] に移動します。  を押して選択します。ディスプレイで  が [オン] の隣に表示されます。
 -  または  を押して [オフ] に移動します。  を押して選択します。ディスプレイで  が [オフ] の隣に表示されます。
-



ハウリング抑制機能のオンとオフの切り替え

この機能により、受信コールでのハウリングを最小限に抑えることができます。





1  を押してメニューにアクセスします  を押します。

2  または  を押して [せってい] に移動し、  を押して選択します。

3  または  を押して [きのうせってい] に移動し、  を押して選択します。

4  または  を押して [ハウリングよくせい] に移動し、  を押して選択します。
または ボタンを使用して、選択したオプションを変更することもできます。



5 次のいずれかを実行します。



-  を押して、ハウリング抑制機能を有効にします。ディスプレイで [ゆうこう] の隣に  が表示されます。
 -  を押して、ハウリング抑制機能を無効にします。 [ゆうこう] の隣から  が消えます。
-



トリル拡張のオンとオフの切り替え

歯茎でのトリル音 (転がるような "R") の単語を多用する言語で話しているとき、この機能を有効にできます。下記の手順に従って、無線機でトリル拡張のオンとオフを切り替えます。









- 以下のいずれか 1 つの手順を実行します。
 - プログラムされた **【トリル拡張】** ボタンを押します。以下の手順をスキップします。
 -  を押してメニューにアクセスします。

-  または  を押して **【せってい】** に移動します。 を押して選択します。

-  または  を押して **【きのうせってい】** に移動します。 を押して選択します。

-  または  を押して **【トリル かくちょう】** に移動します。 を押して選択します。

- 以下のいずれか 1 つの手順を実行します。

-  または  を押して **【オン】** に移動します。 を押して選択します。ディスプレイで  が **【オン】** の隣に表示されます。
-  または  を押して **【オフ】** に移動します。 を押して選択します。ディスプレイで  が **【オフ】** の隣に表示されます。

音声アンビエンス

環境に応じて、無線機の音声アンビエンスをカスタマイズできます。

デフォルト

これはデフォルト設定です。

だいおんりょう













この設定は、ノイズ抑制を有効にしてスピーカの音量を上げ、周囲の騒音が大きい環境でも使用できるようにします。

ワークグループ

この設定は、ハウリング抑制を有効にして **AGC** を無効にし、複数の無線機が相互に近い場所であっても使用できるようにします。

音声アンビエンスの設定

下記の手順に従って、お使いの環境に応じて無線機で音声アンビエンスを設定します。

- 1  を押してメニューにアクセスします。
- 2  または  を押して【せってい】に移動します。 を押して選択します。
- 3  または  を押して【きのうせってい】に移動します。 を押して選択します。
- 4  または  を押して【オンセイ アンビエンス】に移動します。 を押して選択します。
- 5  または  を押して必要な設定に移動します。 を押して選択します。
設定は次のとおりです。
 - 工場出荷時の設定にするには【しょきち】を選択します。

- 【だいおんりょう】を選択し、騒音環境下でスピーカの音量を上げます。
- 【ワーク グループ】を選択し、複数の無線機が相互に近い場所にあるときのハウリングを緩和します。

選択した設定の横に  が表示されます。

音声プロファイル

優先度に応じて、無線機の音声プロファイルをカスタマイズできます。

デフォルト

これはデフォルト設定です。

レベル 1、レベル 2、およびレベル 3



40代、50代、60代以上の成人には、一般的にノイズで誘発される難聴がありますが、これらの設定は、この難聴の特性に応じて音声を補正します。



トレブルブースト、ミッドブースト、およびバスブースト
これらの設定は、金属的な細い音声、鼻声、深い音声などに対応しています。



音声プロファイルの設定



下記の手順に従って、無線機で音声プロファイルを設定します。

- 1  を押してメニューにアクセスします。

- 2  または  を押して【せってい】に移動します。 を押して選択します。

- 3  または  を押して【きのうせってい】に移動します。 を押して選択します。

- 4  または  を押して【オンセイ プロファイル】に移動します。 を押して選択します。

- 5  または  を押して必要な設定に移動します。 を押して選択します。
設定は次のとおりです。

- 【しよきち】を選択して先に選択されていた音声プロファイルを無効にし、工場出荷時の設定に戻ります。
- 40 代以上の成人でみられる騒音性難聴を補正するための音声プロファイルを【レベル 1】、【レベル 2】、または【レベル 3】から選択します。
- 甲高い声、鼻にかかった声、深い声など、お好みに応じて音声プロファイルを【トレブル ブースト】、【ミッド ブースト】、または【バス ブースト】から選択します。

選択した設定の横に  が表示されます。

グローバル ナビゲーション サテライト システム (GNSS) のオンとオフの切り替え

グローバル ナビゲーション サテライト システム (GNSS) は、無線機の正確な位置を測定する衛星ナビゲーションシ



システムです。GNSSには、グローバルポジショニングシステム (GPS) と北斗衛星導航システム (BDS) が含まれます。



**注記:**



選択した無線機のモデルが GPS および BDS を備えていることがあります。GNSS で使用する衛星群は CPS を使用して構成されています。無線機がどのようにプログラムされているかについては、ディーラーまたはシステム管理者に確認してください。

1 下記のいずれかの手順に従って、無線機で GNSS をオンまたはオフに切り替えます。

- プログラムされた **[GNSS]** ボタンを押します。
-  を押してメニューにアクセスします。次の手順に進みます。

2  または  を押して **【せってい】** に移動します。  を押して選択します。

3  または  を押して **【きのうせってい】** に移動します。  を押して選択します。

4  または  を押して **[GNSS]** に移動します。
 を押して選択します。

5  を押して GNSS を有効または無効にします。
有効にすると、✓が**【ゆうこう】**の隣に表示されます。
無効な場合、✓が**【ゆうこう】**の隣で非表示になります。

一般無線機情報

無線機には、一般的パラメータに関する様々な情報が含まれています。

無線機の一般情報は以下のとおりです。

- 無線エイリアスと ID
- ファームウェアとコードプラグの各バージョン
- ソフトウェア更新
- GNSS 情報
- サイト情報

**注記:**

を押して前の画面に戻ります。ホーム画面に戻るには、 を長押しします。無線機は、無操作タイマーの終了後に、現在の画面を終了します。

無線エリアスと ID のチェック

下記の手順に従って、無線機で無線エリアスと ID をチェックします。

- 以下のいずれか 1 つの手順を実行します。
 - プログラムされた **[無線エリアスと ID]** ボタンを押します。以下の手順をスキップします。ポジティブインジケータトーンが鳴ります。プログラムされた **[無線エリアスと ID]** ボタンを押して、前の画面に戻ることができます。
 - を押してメニューにアクセスします。

- または を押して **[せってい]** に移動します。 を押して選択します。

- または を押して **[きき じょうほう]** に移動します。 を押して選択します。

- または を押して **[ID]** に移動します。 を押して選択します。



テキスト行の 1 行目に、無線エリアスが表示されます。テキスト行の 2 行目に、無線機 ID が表示されます。



ファームウェアとコードプラグのバージョンチェック



下記の手順に従って、無線機でファームウェアとコードプラグの各バージョンをチェックします。



- を押してメニューにアクセスします。

- または を押して **[せってい]** に移動します。 を押して選択します。

3  または  を押して【きき じょうほう】に移動します。  を押して選択します。

4  または  を押して【バージョン】に移動します。  を押して選択します。
ディスプレイに現在のファームウェアとコードプラグの各バージョンが表示されます。



3  または  を押して【きき じょうほう】に移動します。  を押して選択します。

4  または  を押して【ソフト アップデート】に移動します。  を押して選択します。
ディスプレイに最新のソフトウェア更新の日付と時刻が表示されます。

ソフトウェア更新情報のチェック

この機能は、OTAP または Wi-Fi を通じて実行された最新のソフトウェア更新の日付と時間を表示します。下記の手順に従って、無線機でソフトウェア更新情報をチェックします。

1  を押してメニューにアクセスします。

2  または  を押して【せってい】に移動します。  を押して選択します。

ソフトウェア更新メニューは、少なくとも 1 回の OTAP または Wi-Fi セッションが正常に完了した後でのみ利用できるようになります。詳細については、「[エア接続プログラミング ページ 488](#)」を参照してください。



GNSS 情報の確認



無線機の GNSS 情報を表示します。



- 緯度
- 経度
- 高度
- 方向
- 速度



- HDOP
- 衛星
- バージョン

- 1  を押してメニューにアクセスします。

- 2  または  を押して【せってい】に移動します。  を押して選択します。

- 3  または  を押して【きき じょうほう】に移動します。  を押して選択します。



- 4  または  を押して【GNSS じょうほう】に移動します。  を押して選択します。



- 5  または  を押して、必要な項目に移動します。  を押して選択します。 要求した **GNSS** 情報がディスプレイに表示されます。



サイト情報の表示

下記の手順に従って、無線機がある現在のサイト名を表示します。

- 1  を押してメニューにアクセスします。

 - 2  または  を押して【せってい】に移動します。  を押して選択します。

 - 3  または  を押して【きき じょうほう】に移動します。  を押して選択します。



 - 4  または  を押して【サイトじょうほう】に移動します。  を押して選択します。



- ディスプレイに現在のサイト名が表示されます。



エンタープライズ Wi-Fi 証明書の詳細の表示

選択したエンタープライズ Wi-Fi 証明書の詳細を表示することができます。

- 1  を押してメニューにアクセスします。

- 2  または  を押して『せってい』に移動します。 を押して選択します。

- 3  または  を押して『証明書メニュー』に移動します。 を押して選択します。
✓ 準備が完了した証明書の横に表示されます。

- 4  または  を押して必要な証明書に移動します。 を押して選択します。

無線機に、証明書の完全な詳細が表示されます。



注記:
準備が完了していない証明書については、ステータスのみ表示されます。

Connect Plus の操作

Connect Plus は、DMR テクノロジーに基づいた完全トランキングソリューションです。Connect Plus は、チャンネルのリクエストと割り当て用に、専用の制御チャンネルを使用します。このシステムで無線機ユーザーが利用可能な機能については、この章で取り扱います。

Connect Plus モードでの追加の無線機コントロール

この章では、無線機ユーザーが事前にプログラムされた手段 (プログラム可能なボタンや割り当て可能な無線機機能など) で利用できる、追加の無線機制御について説明します。

プッシュトゥトーク (PTT) ボタン

無線機の横側にある [PTT] ボタンには基本的に 2 つの目的があります。

- 通話中に [PTT] ボタンを使用して、通話に加わっている他の無線機に送信できます。

話すには、PTT ボタンを押し続けます。相手の声を聞くには、[PTT] ボタンを放します。

[PTT] ボタンを押すと、マイクが有効になります。

- 通話中でないときは、新規通話を発信するために PTT ボタンを使用します (「無線通話の発信 ページ 244」を参照)。

通話許可トーンが有効となっている場合、短いアラートトーンが終了するまで待ってから話します。

プログラム可能ボタン

ディーラーは、ボタンを押す長さに応じて、無線機の機能へのショートカットとして、プログラム可能ボタンを設定できます。

短押し

押してすぐに離します。

長押し

プログラムされた時間の間、押し続けます。



注記:

ボタン押しの長さをプログラミングすれば、割り当てた無線機/ユーティリティの機能や設定に適用できます。[ぎんきゅう] ボタンを押す長さをプログラミングする方法については、「緊急操作 ページ 279」を参照してください。

指定可能な無線機機能

Bluetooth® オーディオ切り替え

内部無線機スピーカと外部 Bluetooth 対応アクセサリの間のオーディオルーティングを切り替えます。

Bluetooth 接続

Bluetooth の検出と接続の動作を開始します。

Bluetooth 切断

無線機と Bluetooth 対応デバイス間のすべての既存の Bluetooth 接続を終了します。

Bluetooth 検出可能

無線機を Bluetooth 検出可能モードに切り替えることができます。

ビジー キューのキャンセル

ビジー キューの非緊急コールが開始された場合に、ビジー モードを終了します。ビジー キューにいったん受け入れられた緊急コールはキャンセルできません。

通話履歴

通話履歴のリストを選択します。

チャンネル アナウンスメント

現在のチャンネルのゾーンとチャンネル アナウンス音声メッセージを示します。

連絡先

連絡先リストに直接アクセスできます。

緊急オン/オフ

プログラムに応じて、緊急通話を始動またはキャンセルします。

ホーン/ライト

ホーンとライト機能のオンとオフを切り替えます。

屋内位置

屋内位置のオンとオフを切り替えます。

Int オーディオ

インテリジェント オーディオのオンとオフを切り替えます。

ダイアル

プログラムに従い、無線機の ID または電話番号を入力して個別コールまたは電話通話を開始します。

ワンタッチ アクセス

事前に定義した個別コール、ページング、クイック テキスト メッセージ、またはホーム復帰を直接開始します。

秘話モード

秘話モードのオンとオフを切り替えます。

無線機チェック

システム内の無線機がアクティブであるかどうかを判別します。

停止解除

ターゲットの無線機を遠隔で有効にできます。

無線停止

相手の無線機を遠隔で無効にできます。

リモート モニタ

インジケータを表示せずにターゲットの無線機のマイクをオンにします。

ホーム チャンネルのリセット

新規ホーム チャンネルを設定します。

アラート音タイプ

アラート音タイプ設定への直接アクセスを提供します。

ローミング要求

異なるサイトの検索を要求します。

スキャン

スキャンのオンとオフを切り替えます。

ホーム チャンネル リマインダのミュート

ホーム チャンネル リマインダをミュートします。

サイト ロック オン/オフ

オンに切り替えた場合、無線機は現在のサイトのみを検索します。オフに切り替えた場合、無線機は現在のサイトに加え、他のサイトも検索します。

テキスト メッセージ

テキスト メッセージ メニューを選択します。

音声ガイド オン/オフ

音声ガイドのオンとオフを切り替えます。

WiFi

Wi-Fi のオンとオフを切り替えます。

ゾーン

ゾーンのリストからの選択を可能にします。

指定可能な設定またはユーティリティ機能

ハウリング抑制

ハウリング抑制機能のオンとオフを切り替えます。

全トーン/アラート

全トーンとアラートのオンとオフを切り替えます。

バックライト輝度

輝度レベルを調節します。

チャンネル アップ/ダウン

プログラムに従い、チャンネルを次のチャンネルまたは前のチャンネルに切り替えます。

表示モード

デイ/ナイト表示モードのオンとオフを切り替えます。

全地球測位システム (GNSS)

衛星ナビゲーション システムのオンとオフを切り替えます。

出力レベル

送信出力レベルの高低を切り替えます。

未登録

ボタン機能が割り当てられていないことを示します。

Connect Plus モードでのステータスインジケータの特定

ディスプレイ アイコン

以下は、無線機のディスプレイに表示されるアイコンです。



受信信号強度インジケータ (RSSI)

表示されるバーの数は、無線機の信号強度を表します。バーが4本のときが最大強度です。このアイコンは受信時のみに表示されます。



Bluetooth 未接続

Bluetooth の機能は有効ですが、接続されているリモートの Bluetooth デバイスはありません。



Bluetooth 接続

Bluetooth 機能が有効です。リモートの Bluetooth デバイスが接続されている間、アイコンは表示されたままになります。



大量データ

大量データを受信中で、チャンネルがビジーです。



屋内位置利用可能⁴

屋内位置ステータスがオンで利用可能です。



屋内位置利用不可⁴

Bluetooth が無効か、ビーコン スキャンが Bluetooth により一時停止しているため、屋内位置ステータスがオンですが利用できません。

⁴ 最新のソフトウェアおよびハードウェアを搭載したモデルにのみ適用されます。

	ミュートモード ミュートモードが有効になると、スピーカーがミュートされます。
	通知 通知リストには確認する項目があります。
	出力レベル 無線機は低出力または高出力に設定されています。
	トーン無効 トーンがオフです。
	オプションボード オプションボードが有効です。
	オプションボード非動作 オプションボードが無効です。
	GNSS 有効

	GPS/GNSS 機能が有効です。 測位を利用できる場合、アイコンは表示されたままになります。
	GNSS 利用不可/範囲外 GPS/GNSS 機能は有効ですが、衛星からデータを受信できません。
	BeiDou のみ利用可能⁵にのみ適用されます。 BeiDou のみの機能が有効になっています。測位を利用できる場合、アイコンは表示されたままになります。
	スキャン スキャン機能が有効になっています。
	緊急 無線機が緊急モードです。
	セキュア 秘話モード機能が有効です。

⁵ XiR M8660i/XiR M8668i/CM7668i



	非セキュア 秘話モード機能が無効です。
	サイト ローミング サイト ローミング機能が有効です。
	連絡先 無線機の連絡先が使用可能です。
	通話履歴 無線機の通話履歴。
	メッセージ 着信メッセージ。
	着信音のみ 呼出音モードが有効です。
	サイレント モード サイレント呼出音モードが有効です。
	バイブ バイブ モードが有効です。

	バイブと呼出音 バイブ モードと呼出音モードが有効です。
	Wi-Fi 優良⁶ Wi-Fi 信号が優良です。
	Wi-Fi 良好⁶ Wi-Fi 信号が良好です。
	Wi-Fi 標準⁶ Wi-Fi 信号が平均的です。
	Wi-Fi 不良⁶ Wi-Fi 信号が不良です。
	Wi-Fi 利用不能⁶ にのみ適用されます。 Wi-Fi 信号を利用できません。

⁶ XiR M8668i/CM7668i

通話アイコン

以下は、通話中に無線機のディスプレイに表示されるアイコンです。これらのアイコンは、ID タイプを示すために連絡先リストにも表示されます。

	<p>個別コール</p> <p>個別コール中であることを示します。 [れんらくさき] リストでは、無線機のエイリアス (名前) または ID (番号) を示します。</p>
	<p>グループコール/サイト一斉コール</p> <p>グループコール中またはサイト一斉コール中であることを示します。 [れんらくさき] リストでは、グループのエイリアス (名前) または ID (番号) を示します。</p>
	<p>個別コールとしての通話</p> <p>個別コールとして通話中であることを示します。</p>
	<p>Bluetooth PC コール</p>

Bluetooth PC コール中であることを示します。

[れんらくさき] リストでは、**Bluetooth PC** コール エイリアス (名前) または ID (番号) を示します。



[ディスパッチ コール]

連絡先タイプのディスパッチ コールは、サードパーティのテキスト メッセージ サーバーを介して、ディスパッチャ PC にテキスト メッセージを送信するために使用されます。

高度なメニューアイコン

以下のアイコンは、2つのオプションのいずれかを選択できるメニュー項目の隣に表示されるか、2つのオプションがあるサブメニューがあることを示すために表示されます。



チェックボックス (空)

オプションが選択されていないことを示します。



チェックボックス (チェックされている)

オプションが選択されていることを示します。



黒く塗りつぶされたボックス

サブメニューがあるメニュー項目のために選択されたオプションを示します。

送信 BOX アイコン

以下のアイコンは、無線機のディスプレイ右上隅にある送信済みアイテムフォルダに表示されます。



送信完了

テキストメッセージは正常に送信されました。

または



実行中



または



- グループのエイリアスまたは ID に対するメッセージの送信が保留中です。
- 送信機のエイリアスまたは ID に対するメッセージの送信は保留中で、承認を待っている状態です。



読み込まれた個別メッセージまたはグループメッセージ

または



メッセージが読み込まれました。

または



読み込まれていない個別メッセージまたはグループメッセージ

メッセージが読み込まれませんでした。



送信失敗



または



メッセージは送信されませんでした。

Bluetooth デバイス アイコン

以下のアイコンも、使用可能な Bluetooth 対応デバイス リストの各項目の横に表示され、デバイスのタイプを示します。

	Bluetooth データ デバイス Bluetooth 対応データ デバイス (スキャナなど)。
	Bluetooth オーディオ デバイス Bluetooth 対応オーディオ デバイス (ヘッドセットなど)。
	Bluetooth PTT デバイス Bluetooth 対応 PTT デバイス (PTT のみデバイス (POD) など)。

LED インジケータ

LED インジケータは、無線機の操作ステータスを示します。

赤色の点滅	無線機が低バッテリー状況で送信しているか、緊急送信を受信しているか、電
--------------	-------------------------------------

	源を入れた際のセルフテストが失敗しています。あるいはオートレンジトランスポンダシステムで設定されている通信圏外にあります。ミュート モードが有効です。
赤色の速い点滅	無線機は、無線ファイル転送 (オプション ボード ファームウェア ファイル、ネットワーク周波数ファイル、またはオプション ボード コードプラグ ファイル) を受信しているか、新しいオプション ボード ファームウェア ファイルにアップグレードしています。
緑色と黄色の点滅	無線機でページングを受信中か、テキスト メッセージを受信したか、スキャンが有効でアクティビティを受信しています。
黄色の点灯	無線機が Bluetooth 検出可能モードになっています。
黄色の 2 回点滅	新規サイトを検索しています。
黄色の点滅	無線機でページングを受信中か、スキャンが有効で、アイドル状態です (アクティビティのために無線機は消音のままです)。



緑色の点灯	無線機は電源が入れられたか、送信しています。
緑色の点滅	電源が入れられたか、通話またはデータを受信しています。
緑色の 2 回の点滅	無線機が秘話対応通話を受信しています。

インジケータ トーン

無線機のスピーカからは、以下のトーンが鳴ります。

高いトーン 低いトーン

タスクを実行するアクションが行われた後、インジケータ トーンによりステータスが音声で通知されます。

	ポジティブ インジケータ トーン
	ネガティブ インジケータ トーン

アラート トーン

アラート トーンは、無線機の状態や無線機が受信したデータへの応答を音で知らせます。

連続トーン 	モノ トーン音。終了まで連続音が鳴ります。
定期トーン 	無線機で設定した期間、定期的に音が鳴ります。トーンが開始、中止、反復されます。
反復トーン 	ユーザーが停止するまで、シングル トーンが繰り返されます。
瞬間トーン 	無線機で定義された短い期間、一度だけ音が鳴りません。

Connect Plus モードと Non-Connect Plus モードの切り替え

ディーラーまたはシステム管理者によってプログラムされている場合、Non-Connect Plus モードに切り替えるには、

別のゾーンに変更する必要があります。無線機に **Non-Connect Plus** ゾーンがプログラムされているかどうか、また、**Non-Connect Plus** ゾーンで動作中に使用できる機能については、ディーラーまたはシステム管理者に確認してください。

Connect Plus モードでの通話の着信と発信

このセクションでは、一般的な無線機の操作と、お使いの無線機で利用できる通話機能について説明します。

サイトの選択

1つのサイトは、特定の1エリアの通信範囲を規定します。1つの **Connect Plus** サイトには、1台のサイトコントローラと最大 **15** 台のリピータがあります。マルチサイトネットワークでは、現在のサイトからの信号レベルが受容できないレベルまで下がると、**Connect Plus** 無線機は、新しいサイトを自動的に検索します。

ローミング要求

ローミング要求は、現在のサイトからの信号が十分であっても、異なるサイトを検索するよう無線機に指示します。

使用可能なサイトが存在しない場合:

- 無線機に [けんさくちゆう] および選択したチャンネルのエイリアスが表示され、サイトリストの検索が継続されます。
- 前のサイトがまだ使用できる場合は、無線機が前のサイトに戻ります。



注記:

ディーラーがプログラムします。

プログラムされた **[ローミング要求]** ボタンを押します。

無線機が新しいサイトに切り替わったことを示すトーンが聞こえます。ディスプレイに [サイト ID < サイト番号 >] が表示されます。

サイト ロック オン/オフ

オンに切り替えた場合、無線機は現在のサイトのみを検索します。オフに切り替えた場合、無線機は現在のサイトに加え、他のサイトも検索します。

プログラムされた **【サイト ロック】** ボタンを押します。

【サイト ロック】 機能をオンに切り替えると、

- ポジティブ インジケータ トーンが聞こえて、無線機が現在のサイトにロックされていることを示しています。
- ディスプレイに『サイト ロック済み』と表示されます。

【サイト ロック】 機能をオフに切り替えると、

- ネガティブ インジケータ トーンが聞こえます。無線機のロックが解除されていることを示しています。
- ディスプレイに『サイト ロックかいじょ』と表示されます。

サイト制限

Connect Plus 無線機システム管理者は、無線機を使用できるネットワーク サイトまたは使用できないネットワーク サイトを指定できます。許可サイトと禁止サイトのリストを変更するために、無線機をプログラミングし直す必要はありません。無線機を禁止サイトに登録しようとする、次のメッセージが短時間表示されます: サイト <指定番号> きんし。その後、無線機では、異なるネットワーク サイトが検索されます。

ゾーン選択





最大 **16** 個の **Connect Plus** ゾーンを無線機にプログラムできます。各 **Connect Plus** ゾーンは、チャンネル セレクタ ノブ上の指定可能な位置を最大 **16** 件含みます。

指定可能な各ノブ位置を使用して、次のいずれかの音声通話タイプを開始できます。

- グループ通話
- マルチグループ コール
- サイト一斉コール

- 個別コール

- 1 下記の手順を実行して、ゾーン機能にアクセスします。

無線機コントロール	手順
プログラムされた【ゾーンせんたく】ボタン	プログラムされた【ゾーンせんたく】ボタンを押します。
無線機メニュー	<p>a  を押してメニューにアクセスします を押します。</p> <p>b  または  を押して【ゾーン】に移動し、 を押して選択します。</p>

現在のゾーンが表示され、✓で示されます。

- 2 必要なゾーンを選択します。

無線機コントロール 手順

 または



 または  を押して必要なゾーンへスクロールします。

- 3  を押して選択します。

ディスプレイに【<ゾーン> せんたくずみ】が一時的に表示され、すぐに選択されたゾーンの画面に戻ります。

複数ネットワークの使用

複数の **Connect Plus** ネットワークを使用するように無線機がプログラムされている場合は、目的のネットワークに割り当てられている **Connect Plus** ゾーンに切り替えると、異なるネットワークを選択できます。このネットワークからゾーンへの割り当ては、無線機プログラミングを使用してディーラーが構成します。

通話タイプの選択

チャンネルセレクトタノブを使用して通話タイプを選択します。無線機のプログラム方法に応じてグループコール、マルチグループコール、サイト一斉コール、または個別コールを選択可能です。チャンネルセレクトタノブが異なる位置(通話タイプが割り当てられている位置)に変更されるため、無線機を **Connect Plus** サイトに再登録する必要があります。無線機は、新しいチャンネルセレクトタノブ位置の通話タイプにプログラムされている登録グループIDに登録します。

通話タイプが割り当てられていない位置を選択した場合、無線機は連続トーンを鳴らし、ディスプレイに「プログラムNG」と表示されます。プログラムされていないチャンネルを選択した場合、無線機は動作しないため、選択せずにチャンネルセレクトタノブを使用して、プログラムされているチャンネルを選択してください。

必要なゾーンが表示されたら(無線機に複数のゾーンがある場合)、プログラムされているチャンネルセレクトタノブを回して通話タイプを選択します。

無線通話の受信と応答

チャンネル、無線機IDまたは通話タイプが表示されたら、通話の受信や応答に進むことができます。

無線機が送信している間は緑色のLEDが点灯し、無線機が受信している間は緑色に点滅します。



注記:

無線機が送信している間は緑色のLEDが点灯し、秘話対応通話を受信すると緑色で2回点滅します。秘話対応通話のスクランブルを解除するには、お使いの無線機が、送信側無線機(通話を受信している無線機)と同一のプライバシーキー、または同一のキー値とキーID(ディーラーがプログラミング)を有している必要があります。

詳細については、「[秘話モード ページ 298](#)」を参照してください。

グループコールの受信と応答

ユーザーグループからの通話を受信するには、無線機がそのグループの一部として設定されている必要があります。

グループコールを受信する場合(ホーム画面で)、緑色のLEDが点滅します。右上端にグループコールのアイコンが表示されます。テキスト行の1行目に発信者のエイリアスが表示されます。テキスト行の2行目に、グループコー

ル エイリアスが表示されます。無線機の消音が解除され、着信通話の音は無線機のスピーカから聞こえます。

- 1 無線機を口から 1 ~ 2 インチ (2.5 ~ 5.0 cm) の場所に保持します。

LED が緑色で点灯します。

- 2 通話許可トーンの 1 つが完了するまで待機し (有効な場合)、マイクに向かってはっきりと話します。

- 3 相手の声を聞くには、**PTT** ボタンを放します。

音声アクティビティがないまま、事前に定められた時間が経過すると、通話が終了します。



注記:

グループ コールの詳細については、「[グループ コールの発信 ページ 245](#)」を参照してください。

個別コールの受信と応答

個別コールとは、1 台の無線機から別の 1 台の無線機への通話です。

個別コールを受信すると、緑色の LED が点滅します。ディスプレイの 1 行目に、無線機のエイリアスまたは ID と RSSI アイコンが表示されます。2 行目には、【こべつ コー

ル】と個別コール アイコンが表示されます。無線機のミュートが解除され、着信通話の音は無線機のスピーカから聞こえます。

- 1 無線機を口から 1 ~ 2 インチ (2.5 ~ 5.0 cm) の場所に保持します。

- 2 電話に応答するには、**[PTT]** ボタンを押します。

LED が緑色で点灯します。

- 3 通話許可トーンが完了するまで待機し (有効な場合)、マイクに向かってはっきりと話します。

- 4 相手の声を聞くには、**PTT** ボタンを放します。

音声アクティビティがないまま、事前に定められた時間が経過すると、通話が終了します。

ディスプレイに【コールしゅうりょう】と表示されます。

個別コールの詳細については、「[個別コールの発信 ページ 245](#)」を参照してください。

サイト一斉コールの受信

サイト一斉コールは、個々の無線機から、対象サイトの全無線機へのコールです。ユーザーの注意を十分に促す必要がある重要な通知に使用されます。

サイト一斉コールを受信するとトーンが鳴り、緑色の LED が点滅します。

右上端にグループ コールアイコンが表示されます。テキスト行の **1** 行目に発信者のエイリアスが表示されます。テキスト行の **2** 行目に、[サイトいっせいコール] と表示されます。無線機の消音が解除され、着信通話の音は無線機のスピーカから聞こえます。

サイト一斉コールが終了すると、通話を受信する前の画面に戻ります。サイト一斉コールは、終了前の事前に定められた時間中、待機しません。

サイト一斉コールには応答できません。



注記:

サイト一斉コールの詳細については、[サイト一斉コールの発信 ページ 246](#) を参照してください。

通話を受信中に別のチャンネルに切り替える場合、無線機はサイト一斉コールの受信を停止します。サイト一斉コール中、通話が終了するまで、プログラムされたボタン機能のいずれも使うことはできません。

着信個別無線通話の受信

着信個別無線通話を受信するとき、個別コールとしての通話アイコンが右上端に表示されます。テキスト行の **1** 行目に、[でんわ] と表示されます。

- 1 通話を開始するには、**PTT** ボタンを押し続けます。相手の声を聞くには、**PTT** ボタンを放します。



- 2  を長押しして、通話を終了します。

ディスプレイの **1** 行目に [でんわ] と表示されます。ディスプレイの **2** 行目に [せつだん] と表示されます。ディスプレイは通話画面に戻ります。ディスプレイに [でんわしゅうりょう] と表示されます。

個別電話着信でバッファされたオーバーダイアルを作成

通話中、右上端に個別コールとしての通話アイコンが表示されます。ディスプレイの最初の行に【でんわ】と表示されます。

- 1 キーパッドを使用して数字を入力し、 ボタンを押します。

ポーズを挿入するには、 を押して、2 秒以内に  を押します。ディスプレイ上の【*】と【#】が【P】で置き換えられます。

個別コールとしての通話アイコンが右上端に表示されます。ディスプレイの最初の行には入力した数字が表示されます。

- 2 通話を終了するには、 を長押しします。
ディスプレイの 1 行目に【でんわ】と表示されます。
ディスプレイの 2 行目に【せつだん】と表示されます。
ディスプレイは通話画面に戻ります。

ディスプレイに【でんわしゅうりょう】と表示されます。

個別電話着信でライブ オーバーダイアルを作成

通話中、右上端に個別コールとしての通話アイコンが表示されます。ディスプレイの最初の行に【でんわ】と表示されます。

- 1 **PTT** ボタンを押し、キーパッドを使って、数字を入力します。

個別コールとしての通話アイコンが右上端に表示されます。ディスプレイの最初の行にはライブ ダイアルの数字が表示されます。

- 2 通話を終了するには、 を長押しします。

ディスプレイの 1 行目に【でんわ】と表示されます。
ディスプレイの 2 行目に【せつだん】と表示されます。
ディスプレイは通話画面に戻ります。

ディスプレイに【でんわしゅうりょう】と表示されます。

着信電話グループ通話の受信

着信電話グループ通話を受信するとき、グループコールアイコンが右上隅に表示されます。テキストの1行目に【Call 1】と表示されます。

話すときには **PTT** ボタンを押し、聞くときにはボタンを放します。

着信マルチグループ通話

着信マルチグループ通話を受信すると、右上隅にグループコールアイコンが表示されます。テキスト行の1行目に【Multigroup call】(マルチグループ コール)と表示され、無線機の消音が解除され、着信マルチグループ通話の音が無線機のスピーカから聞こえます。

無線通話の発信

チャンネルの選択後、次のものを使用して、無線機のエイリアスまたは ID、またはグループのエイリアスまたは ID を選択できます。

- チャンネルセレクタノブ
- プログラムされた【ワンタッチアクセス】ボタン - ワンタッチアクセス機能を使用して、事前に設定された ID に対し、簡単に個別通話かけることができます。この機能は、ボタンを短くまたは長く押すという、プログラム可能なボタンの押し方に割り当てることができます。ワンタッチアクセス ボタンには1つの ID だけを割り当てることができます。お使いの無線機で、複数の【ワンタッチアクセス】ボタンをプログラムできます。
- 連絡先リスト ([連絡先設定 ページ 267](#) を参照)。



注記:

秘話対応送信を送るには、お使いの無線機のチャンネルで秘話機能が有効になっている必要があります。お使いの無線機と同じキー値とキー ID を持つ相手先無線機のみが、送信のスクランブルを解除できます。

詳細については、「[秘話モード ページ 298](#)」を参照してください。

チャンネルセレクト ノブを使った通話の発信

この機能を使用すると、無線機ユーザーは、さまざまな通話タイプ(グループコール、個別通話、サイト一斉コール、マルチグループコール)を使用できるようになります。

グループコールの発信

ユーザーのグループに通話を発信するには、無線機がそのグループの一部として設定されている必要があります。

- 1 アクティブなグループのエイリアスまたは ID のチャンネルを選びます。「[通話タイプの選択 ページ 240](#)」を参照してください。

- 2 無線機を口から 1 ~ 2 インチ (2.5 ~ 5.0 cm) の場所に保持します。

- 3 **PTT** ボタンを押して通話を発信します。

緑色の LED が点灯します。グループコールアイコンが右上端に表示されます。テキスト行の 1 行目には、グループコールのエイリアスが表示されます。

- 4 通話許可トーンが完了するまで待機し (有効な場合)、マイクに向かってはっきりと話します。

- 5 相手の声を聞くには、**PTT** ボタンを放します。

相手先の無線機が応答すると、緑色の LED が点滅します (無線機の消音解除され、応答は無線機のスピーカから聞こえます)。ディスプレイに、グループコールアイコン、送信中の無線機のエイリアスまたは ID が表示されます。

音声アクティビティがないまま、事前に定められた時間が経過すると、通話が終了します。コールを開始する前の画面に戻ります。

個別コールの発信

許可を受けた個別の無線機が開始した個別コールの受信や応答を行うには、お使いの無線機が個別コールを開始できるようにプログラムされている必要があります。

この機能が無効である場合に、**ワンタッチアクセス** ボタン、またはチャンネルセレクト ノブを使用して個別コールを試みると、ネガティブインジケータトーンが鳴ります。

- 1 次のいずれかを実行します。

- アクティブな無線機のエイリアスまたは ID のチャンネルを選びます。「[通話タイプの選択 ページ 240](#)」を参照してください。
- プログラムされた [**ワンタッチ アクセス**] ボタンを押します。

2 無線機を口から 1 ~ 2 インチ (2.5 ~ 5.0 cm) の場所に保持します。

3 PTT ボタンを押して通話を発信します。

LED が緑色で点灯します。個別コールアイコンが右上端に表示されます。テキスト行の 1 行目に、ターゲット無線機のエイリアスが表示されます。テキスト行の **2** 行目に、通話ステータスが表示されます。

4 通話許可トーンが完了するまで待機し (有効な場合)、マイクに向かってはっきりと話します。

5 相手の声を聞くには、**PTT** ボタンを放します。

相手先の無線機が応答すると、緑色の LED が点滅します

音声アクティビティがないまま、事前に定められた時間が経過すると、通話が終了します。短いトーン

が聞こえます。ディスプレイに「コールしゅうりょう」と表示されます。

個別コールを設定する前に、無線機プレゼンスチェックを実行するように無線機をプログラムできます。相手の無線機が利用不可の場合、短いトーンが鳴り、ネガティブミニ通知がディスプレイに表示されます。

サイト一斉コールの発信

この機能を使用すると、現在別の通話を行っていない、対象サイトのすべてのユーザーに対して送信できます。この機能を使用するには、無線機をプログラムする必要があります。

チャンネル/サイトのユーザーはサイト一斉コールに応答することはできません。

1 アクティブなサイト一斉コールグループのエイリアスのチャンネルを選択します。「[通話タイプの選択 ページ 240](#)」を参照してください。

2 無線機を口から 1 ~ 2 インチ (2.5 ~ 5.0 cm) の場所に保持します。

3 PTT ボタンを押して通話を発信します。

LED が緑色で点灯します。グループ コール アイコンが右上端に表示されます。テキスト行の 1 行目に、[Site All Call] (サイトいっせいコール) と表示されます。

4 通話許可トーンが完了するまで待機し (有効な場合)、マイクに向かってはっきりと話します。

通話許可トーンが完了するまで待機し (有効な場合)、マイクに向かってはっきりと話します。

マルチグループ コールの発信

この機能により、複数グループのすべてのユーザーに送信できます。この機能を使用するには、無線機をプログラムする必要があります。



注記:

グループのユーザーは、マルチグループ コールに応答できません。

1 チャンネル セレクタ ノブを回してマルチグループのエイリアスまたは ID を選択します。

2 PTT ボタンを押して通話を発信します。

LED が緑色で点灯します。ディスプレイにマルチグループのエイリアスまたは ID が表示されます。

ワンタッチ コール ボタンを使用した個別 コールの発信



注記:

プログラム可能ボタンは、ホーム画面から押し始める必要があります。

ワンタッチ コール機能を使用すると、事前定義された個別コール エイリアスまたは ID に対する個別コールを簡単に発信できます。この機能は、ボタンを短くまたは長く押すという、プログラム可能なボタンの押し方に割り当てることができます。

ワンタッチ コール ボタンに指定されるエイリアスまたは ID は 1 つのみです。無線機には、複数のワンタッチ コール ボタンをプログラムできます。

1 プログラムされた [ワンタッチ コール] ボタンを押し、事前に定義された個別通話エイリアスまたは ID に個別コールを発信します。

2 無線機を口から 1 ~ 2 インチ (2.5 ~ 5.0 cm) の場所に保持します。

3 **PTT** ボタンを押して通話を発信します。

LED が緑色で点灯します。

ディスプレイに個別コール エイリアスまたは ID が表示されます。

4 通話許可トーンが完了するまで待機し (有効な場合)、マイクに向かってはっきりと話します。

5 相手の声を聞くには、**PTT** ボタンを放します。

ターゲットの無線機が応答すると、LED が緑色に点滅します。

音声アクティビティがないまま、事前に定められた時間が経過すると、通話が終了します。

プログラム可能なダイアル ボタンで通話を行う

この機能を使用すると、無線機ユーザーは、プログラム可能なダイアル ボタンを使用して個別通話を発信できます。

個別コールの発信

1 プログラムされた **[ダイアル]** ボタンを押して、**[ダイアル]** 画面を表示します。

ディスプレイに「ばんごう:」と表示されます。

2 キーパッドを使用して、無線機のエイリアスまたは個別 ID を入力します。

3 無線機を口から 1 ~ 2 インチ (2.5 ~ 5.0 cm) の場所に保持します。

4 **PTT** ボタンを押して通話を発信します。

LED が緑色で点灯します。個別コールアイコンが右上端に表示されます。テキスト行の 1 行目に無線機のエイリアスが表示されます。テキスト行の 2 行目に、通話ステータスが表示されます。

5 通話許可トーンが完了するまで待機し (有効な場合)、マイクに向かってはっきりと話します。

6 相手の声を聞くには、**PTT** ボタンを放します。

ターゲットの無線機が応答すると、LED が緑色に点滅します。



音声アクティビティがないまま、事前に定められた時間が経過すると、通話が終了します。短いトーンが聞こえます。ディスプレイに【コールしゅうりょう】と表示されます。

プログラム可能なダイヤル ボタンからの個別電話発信

- 1 プログラムされた【ダイヤル】ボタンを押して、【ダイヤル】画面を表示します。

ディスプレイに【ばんごう:】と表示されます。

- 2 キーパッドを使用して、電話番号を入力し、 を押して、入力した番号に電話をかけます。

 を押して、不要な文字を削除します。ポーズを挿入するには、 を押して、2秒以内に  を押します。ディスプレイ上の【*】と【#】が【P】で置き換えられます。

処理が正常に行われると、ディスプレイの1行目に【でんわ】と表示されます。ディスプレイの2行目には、ダイヤルした電話番号が表示されます。

無効な電話番号を選択した場合、ディスプレイにはネガティブミニ通知【でんわ NG】、【リソースしようふか】、または【むこうなけんげん】が表示されます。

電話番号を入力せずに  を押すと、無線機から最初にポジティブインジケータトーンが聞こえ、続けてネガティブインジケータトーンが聞こえます。ディスプレイの表示は変わりません。



- 3 通話を終了するには、 を長押しします。

ディスプレイの1行目に【でんわ】と表示されます。ディスプレイの2行目に【せつだん】と表示されます。

ディスプレイに【でんわしゅうりょう】と表示されます。

【Tel】メニューからの個別無線通信発信



- 1  を押してメニューにアクセスします を押します。

2  または  を押して [TEL] に移動し、 を押して選択します。

3  を押して、[ダイヤル] を選択します。

ディスプレイの最初の行に [ばんごう] が表示され、2 番目の行に点滅するカーソルが表示されます。

4 キーパッドを使用して、電話番号を入力し、 を押して、入力した番号に電話をかけます。

 を押して、不要な文字を削除します。ポーズを挿入するには、 を押して、2 秒以内に  を押します。ディスプレイ上の [*] と [#] が [P] で置き換えられます。

処理が正常に行われると、ディスプレイの 1 行目に [でんわ] と表示されます。ディスプレイの 2 行目には、ダイヤルした電話番号が表示されます。

無効な電話番号を選択した場合、ディスプレイにはネガティブ ミニ通知 [でんわ NG]、[リソースしようふか]、または [むこうなけんげん] が表示されます。

電話番号を入力せずに  を押すと、無線機から最初にポジティブ インジケータ トーンが聞こえ、続けてネガティブ インジケータ トーンが聞こえます。ディスプレイの表示は変わりません。

5 通話を終了するには、 を長押しします。

ディスプレイの 1 行目に [でんわ] と表示されます。ディスプレイの 2 行目に [せつだん] と表示されます。

ディスプレイに [でんわしゅうりょう] と表示されます。



連絡先からの個別無線通話発信









注記:

MOTOTRBO Connect Plus オプション ボード CPS で [ダイヤル] が無効化されている場合、メニューに [TELばんごう] 項目は表示されません。

1  を押してメニューにアクセスします を押します。

2  または  を押して【れんらくさき】に移動し、 を押して選択します。



3  または  を押して【ダイアル】に移動し、 を押して選択します。

4  または  を押して【TELばんごう】に移動し、 を押して選択します。

ディスプレイの最初の行に【ばんごう】が表示され、2番目の行に点滅するカーソルが表示されます。

5 キーパッドを使用して、電話番号を入力し、 を押して、入力した番号に電話をかけます。

PTT ボタンを押すと、ディスプレイにはネガティブミニ通知【そうしん > 【OK】】が表示され、前の画面に戻ります。

 を押して、不要な文字を削除します。ポーズを挿入するには、 を押して、2秒以内に  を

押します。ディスプレイ上の【*】と【#】が【P】で置き換えられます。

処理が正常に行われると、ディスプレイの1行目に【でんわ】と表示されます。ディスプレイの2行目には、ダイアルした電話番号が表示されます。

電話番号を入力せずに  を押すと、無線機から最初にポジティブインジケータトーンが聞こえ、続けてネガティブインジケータトーンが聞こえます。ディスプレイの表示は変わりません。

6 通話を終了するには、 を長押しします。

ディスプレイの1行目に【でんわ】と表示されます。ディスプレイの2行目に【せつだん】と表示されます。

ディスプレイに【でんわしゅうりょう】と表示されます。

発信個別無線通話でのチャネル許可の待機

個別無線通話を行うとき、ディスプレイの1行目に【でんわ】と表示されます。ディスプレイの2行目には、ダイヤルした電話番号が表示されます。

コールがつながると、右上隅に個別コールとしての通話アイコンが表示されます。ディスプレイの1行目に電話番号が表示されます。

失敗した場合、ディスプレイにネガティブのミニ通知、【でんわ NG】、【リソースしようふか】または【Invalid Permissions】(むこうなけんげん)が表示されます。



通話を終了するには、 を長押しします。

ディスプレイが前の画面に戻ります。

接続された個別電話発信でバッファされたオーバーダイアルを作成

通話中、右上端に個別コールとしての通話アイコンが表示されます。ディスプレイの最初の行には電話番号が表示されます。

- 1 キーパッドを使用して数字を入力します。

 を押して、不要な文字を削除します。ポーズを挿入するには、 を押して、2秒以内に  を押します。ディスプレイ上の【*】と【#】が【P】で置き換えられます。



ディスプレイの最初の行に【つかケタ】と表示され、2行目に入力した数字が表示されます。

- 2  ボタンを押します。

PTT ボタンを押すと、ディスプレイにはネガティブのミニ通知 [そうしん > 【OK】] が表示され、前の画面に戻ります。

個別コールとしての通話アイコンが右上端に表示されます。ディスプレイの最初の行には電話番号と追加されたオーバーダイアルの数字が表示されます。

3 次のいずれかを実行します。

-  を押して通話画面に戻ります。
- 通話を終了するには、 を長押しします。

接続された個別電話発信でライブ オーバーダイアルを作成

通話中、右上端に個別コールとしての通話アイコンが表示されます。ディスプレイの最初の行には電話番号が表示されます。

1 **PTT** ボタンを押し、キーパッドを使って、数字を入力します。

個別コールとしての通話アイコンが右上端に表示されます。ディスプレイの最初の行には電話番号と追加されたオーバーダイアルの数字が表示されます。

2 通話を終了するには、 を長押しします。

ディスプレイの 1 行目に【でんわ】と表示されます。ディスプレイの 2 行目に【せつだん】と表示されます。

ディスプレイに【でんわしゅうりょう】と表示されます。

Connect Plus モードでの高度な機能

この章では、無線機で使用できる機能の操作について説明します。

ホーム チャネル リマインダ

これは、無線機が一定期間ホーム チャネルにセットされていない場合に通知を出す機能です。

CPS を使用してこの機能を有効にしている場合は、無線機がホーム チャネルに設定されないまま一定期間経過すると、ホーム チャネル リマインダのトーンとアナウンスが鳴り、ディスプレイの 1 行目に「ノン」、2 行目に「ホーム チャネル」と定期的に表示されます。

次のいずれかの操作を実行して、この通知に応答できます。

- ホーム チャネルに戻る。
- プログラム可能ボタンを使用して、通知を一時的にミュートする。

- プログラム可能ボタンを使用して、新しいホーム チャンネルを設定する。

自動フォールバック

自動フォールバックは、**Connect Plus** システムに特定のタイプの障害が発生したときに、選択したグループ連絡先に対する非緊急コールの発信および受信を続行できるシステム機能です。

該当するいずれかの障害が発生した場合、無線機では、異なる **Connect Plus** サイトへのローミングを試みます。この検索プロセスの結果、無線機で動作可能な **Connect Plus** サイトが見つかることもあれば、"フォールバック チャンネル"が見つかることもあります (自動フォールバックを有効にしてある無線機の場合)。フォールバック チャンネルは、通常は動作可能な **Connect Plus** サイトの一部である一方で、現在は、サイト コントローラと **Connect Plus** ネットワークのいずれとも通信できないリピータです。フォールバックモードでは、リピータは、シングル デジタル リピータとして動作します。自動フォールバック モードでは、非緊急グループ コールのみがサポートされます。他の通話タイプは、フォールバック モードではサポートされません。

自動フォールバック モードの通知

無線機でフォールバック チャンネルを使用している場合は、断続的な "フォールバック トーン" が約 **15 秒**ごとに **1 回**鳴ります (送信中を除く)。ディスプレイに [きりもどしチャンネル] という短いメッセージが定期的に表示されます。無線機では、選択したグループ連絡先での **PTT** のみが許可されます (グループ コール、マルチグループ コール、サイト一斉コール)。その他のタイプの通話は発信できません。

フォールバックモードでの通話の発信/受信



注記:

通話は、同じフォールバックチャンネルをモニタしており、同じグループで選択されている無線機によってのみ受信されます。通話は、他のサイトや他のリピータには、ネットワーク送信されません。

緊急音声通話や緊急アラートは、フォールバックモードでは使用できません。フォールバックモードで緊急ボタンを押すと、無効なキーを押したときのトーンが無線機から鳴ります。ディスプレイを装備した無線機では、[きのうりようふか]というメッセージも表示されます。

個別(無線機から無線機への)通話と電話通話は、フォールバックモードでは使用できません。個別連絡先への通話を試みると、拒否トーンが鳴ります。この時点では、目的のグループ連絡先を選択する必要があります。サポートされていない他のコールとしては、リモート モニタ、ページング、無線機チェック、無線停止解除、無線停止、テキストメッセージング、位置更新、パケット データ コールがあります。

拡張トラフィック チャンネル アクセス (ETCA) は、自動フォールバックモードでは、サポートされませ

ん。2人以上の無線機ユーザーが同時(またはほぼ同時)にPTTを押した場合は、PTTを放すまで両方の無線機から送信できることがあります。この場合は、受信側の無線機でいずれの送信も判別できないおそれがあります。

フォールバックモードでの通話の発信は、通常の機能と同様です。単に、使用するグループ連絡先を選択(無線機の通常のチャンネル選択方法を使用)し、PTTを押して通話を開始します。チャンネルが、別のグループによってすでに使用されていることがあります。チャンネルが使用中の場合は、ビジートーンが鳴り、ディスプレイに[チャンネルビジー]と表示されます。無線機の通常のチャンネル選択方法を使用して、グループ、マルチグループ、またはサイト一斉コールの連絡先を選択できます。無線機がフォールバックチャンネルで動作している間、マルチグループは、他のグループ同様に動作します。現在、同じマルチグループとして選択されている無線機によってのみ受信されます。

通常動作への復帰

フォールバックリピータの範囲に入っているときにサイトが通常のトランキング動作に戻ると、無線機は自動フォールバックモードを自動的に終了します。無線機の登録が正常に完了すると、登録"ビープ"が鳴ります。動作可能なサイト、つまりフォールバックモードでないサイトの範囲に入っている場合は、ローミング要求ボタン(無線機にプログ

ラムされている場合)を押して、無線機に利用可能なサイトを強制的に検索させ、このサイトに登録させることができます。利用可能な他のサイトがない場合、無線機は検索の完了後に、自動フォールバックモードに戻ります。フォールバックリピータの通信範囲外に移動すると、無線機は検索モードを開始します(ディスプレイに「けんさくちゅう」と表示)。











無線機チェック



有効である場合、この機能を使用することで、システム内の他の無線機がアクティブであるかどうかを、その無線機のユーザーを呼び出さずに判断できます。ターゲットの無線機には、音声や映像による通知は行われません。

この機能は、無線機のエリアスまたは ID にのみ適用されます。

無線機チェックの送信

- 1 無線機チェック機能にアクセスします。

無線機 コント ロール	手順
プログラムされた無線機チェックボタン	<p>a プログラムされた [無線機チェック] ボタンを押します。</p> <p>b  または  を押して必要な無線機エリアスまたは ID に移動し、  を押して選択します。</p>
メニュー	<p>a  を押してメニューにアクセスしますを押します。</p> <p>b  または  を押して「れんらくさき」に移動し、  を押して選択します。</p> <p>c  または  を押して必要な無線機エリアスまたは ID に移動し、  を押して選択します。</p>

無線機 コント ロール	手順
	<p>d  または  を押して [むせんきチェック] に移動し、  を押して選択します。</p>

ディスプレイにターゲット エイリアスが表示され、要求が処理中であることが示されます。LED が緑色で点灯します。

2 確認応答を待ちます。

ターゲットの無線機がシステムでアクティブな場合は、トーンが鳴り、ディスプレイに [むせんきしようか] と表示されます。

ターゲットの無線機がシステムでアクティブでない場合は、トーンが鳴り、ディスプレイに [むせんきしようふか] と表示されます。

メニューから開始した場合、無線機のエイリアスまたは ID の画面に戻ります。

プログラム可能ボタンから開始した場合は、ホーム画面に戻ります。

[リモート モニタ]

リモート モニタ機能を使用して、ターゲット無線機のマイクをオンにします (無線機のエイリアスまたは ID のみ)。ターゲット無線機で緑色の LED が一度点滅します。この機能を使用することで、ターゲット無線機の周りのあらゆる音声アクティビティを遠隔でモニタできます。

この機能を使用するには、無線機をプログラムする必要があります。











リモート モニタの開始









注記:

リモート モニタは、プログラムされた期間の後、または送信の開始、チャンネルの変更、または電源オフが試行されたときに、自動的に停止します。

- 1 リモート モニタ機能にアクセスします。

無線機 コント ロール	手順
プログラ ムされ た【リ モート モニタ ボタン	<p>a プログラムされた【リモート モニタ】ボタンを押します。</p> <p>b  または  を押して必要な無線機エイリアスまたは ID に移動し、 を押して選択します。</p>
メニュー	<p>a  を押してメニューにアクセスしますを押します。</p> <p>b  または  を押して【れんらくさき】に移動し、 を押して選択します。</p> <p>c  または  を押して必要な無線機エイリアスまたは ID に移動し、 を押して選択します。</p>

無線機 コント ロール	手順
	<p>d  または  を押して【ダイアル】に移動し、 を押して選択します。</p> <p>e  または  を押して【リモート モニタ】に移動し、 を押して選択します。</p>

テキスト行の 1 行目に、【きょうせいモニタ】と表示されます。テキスト行の 2 行目に、ターゲットエイリアスが表示され、要求が処理中であることが示されます。LED が緑色に点滅します。

2 確認応答を待ちます。

成功すると、ポジティブインジケータトーンが鳴り、短時間だけディスプレイに【きょうせいモニタかんりょう】と表示されます。プログラムされた期間、モニタ対象の無線機から音声の再生が開始され、ディスプレイに【きょうせいモニタ】、ターゲットエイリアスの順に表示されます。タイマーが終了する

と、無線機から警告トーンが鳴り、LED が消灯します。

失敗の場合、ネガティブ インジケータ トーンが鳴り、ディスプレイに【きょうせいモニタしつぱい】と表示されます。

スキャン

この機能を使用すると、無線機では、事前プログラム済みスキャン リストで定義されたグループに対して、通話をモニタし、これに参加できます。スキャンが有効の場合、ステータス バーにスキャン アイコンが表示され、アイドル状態のときに LED が黄色に点滅します。







スキャンの開始と停止



注記:

この手順で、現在選択されているゾーンと同じネットワーク ID を持つすべての **Connect Plus** ゾーンのスキャン機能をオンまたはオフにします。この手順でスキャン機能をオンにしても、スキャン リストの一部 (またはすべて) のグループのスキャン機能は引き続き無効な場合がありますので注意してください。詳細については、「[スキャン リストの編集 ページ 262](#)」を参照してください。

スキャンを開始および停止するには、プログラムされた【スキャン】ボタンを押すか、または次に説明する手順を実行してください。

- 1  を押してメニューにアクセスします を押しします。
- 2  または  を押して【スキャン】に移動し、 を押して選択します。
- 3  または  を押して【オン】または【オフ】に移動し、 を押して選択します。
 - スキャンが有効な場合は、ディスプレイに【スキャン オン】と表示されます。
 - スキャンが有効な場合は、【スキャン】メニューに【オフ】が表示されます。
 - スキャンが無効な場合は、ディスプレイに【スキャン オフ】と表示されます。
 - スキャンが無効な場合は、【スキャン】メニューに【オン】が表示されます。

スキャン中の送信への応答

スキャン中、無線機はアクティビティが検知されたグループで停止します。無線機は、制御チャンネルでアイドル状態のときに、スキャン リストのメンバーを常に待ち受けます。

- 1 無線機を口から 1 ~ 2 インチ (2.5 ~ 5.0 cm) の場所に保持します。
- 2 ハング タイム中に **PTT** ボタンを押します。
LED が緑色で点灯します。
- 3 通話許可トーンが完了するまで待機し (有効な場合)、マイクに向かってはっきりと話します。
- 4 相手の声を聞くには、**PTT** ボタンを放します。
ハング タイム中に応答しないと、無線機は他のグループのスキャンに戻ります。

ユーザー設定可能スキャン

[へんしゅうリスト] メニューが有効になっている場合、ユーザーが [メンバーついか] メニューからスキャン メンバーの追加と削除ができます。スキャン リスト メンバーは、現在選択されているゾーンと同じネットワーク ID を持つ、

Connect Plus ゾーンのチャンネル選択位置に現在割り当てられているレギュラー グループ連絡先 (たとえば、マルチグループ、またはサイト一斉コール/ネットワーク全体の一斉コールではない) である必要があります。また、グループのエイリアスも、現在のゾーン スキャン リストに含まれているグループと一致してはなりません。

スキャンは、メニューを使用するか、プログラムされた [**スキャン オン/オフ**] ボタンを押すことにより、オンまたはオフにできます。

この機能は、無線機が現在通話中でない場合のみ動作します。通話を聞いている最中は、無線機で他のグループ コールをスキャンできないため、他のグループ コールが進行中であることを認識しません。通話は終了すると、無線機は制御チャンネル タイム スロットに戻り、スキャン リストにあるグループをスキャンできます。

スキヤンのオンとオフの切り替え







注記:



この手順で、現在選択されているゾーンと同じネットワーク ID を持つすべてのゾーンのスキヤン機能をオンまたはオフにします。この手順でスキヤン機能をオンにしても、スキヤン リストの一部(またはすべて)のグループのスキヤン機能は引き続き無効な場合がありますので注意してください。詳細については、次のセクションを参照してください。

スキヤンがオンになっていると、スキヤン アイコンがディスプレイに表示されます。スキヤンがオンであり、通話に参加していない場合は、黄色と緑の LED が点滅します。

スキヤンをオンまたはオフにする手順は、無線機のプログラム方法によって異なります。スキヤン オン/オフ ボタンがプログラムされている場合は、そのボタンを使用して、この機能のオンとオフを切り替えます。メニューからスキヤンをオンまたはオフにできるように無線機がプログラムされている場合は、次の手順に従います。

- 1  を押してメニューにアクセスします を押します。

- 2  または  を押して【スキヤン】に移動し、
 を押して選択します。

- 3  または  を押して【オン】または【オフ】に移動し、
 を押して選択します。
 - スキヤンが無効の場合は、短時間だけディスプレイに【スキヤン オン】と表示されます。
 - スキヤンが有効の場合は、短時間だけディスプレイに【スキヤン オフ】と表示されます。

スキャン リストの編集



注記:

スキャン リストのエントリが現在選択されているグループとたまたま一致していた場合、リスト エントリに現在チェック マークが表示されているかどうかにかかわらず、無線機はこのグループのアクティビティを待ち受けます。無線機が通話中でない場合、無線機は、選択されているグループ、マルチグループ、サイト一斉コール、および既定の緊急復帰グループ (構成済みの場合) でのアクティビティを必ず待ち受けます。この動作は無効にできません。スキャンがオンの場合、無線機では有効なゾーン スキャン リスト メンバーのアクティビティを待ち受けます。

スキャン リストによって、スキャンできるグループが決まります。このリストは、無線機をプログラムするときに作成されます。無線機がスキャン リストの編集を許可するようプログラムされていると、以下が可能です。

- リストの個々のグループに対してスキャンをオン/オフにします。
- [メンバーつか] メニューからスキャン メンバーを追加および削除します。「[メンバーつか] メニューからのグループの追加または削除 ページ 263」を参照してください。





注記:

スキャン リスト メンバーは、現在選択されているゾーンと同じネットワーク ID を持つ、Connect Plus ゾーンのチャンネル選択位置に現在割り当てられているレギュラー グループ連絡先 (マルチグループ、またはサイト一斉コール/ネットワーク全体の一斉コールではない) である必要があります。また、グループのエイリアスも、現在のゾーン スキャン リストに含まれているグループと一致してはなりません。



1

 を押してメニューにアクセスします を押します。

2

 または  を押して [リストへんしゅう] に移動し、 を押して選択します。

3

 または  を押して目的のグループ名に移動します。

グループ名の前にチェック マークが付いている場合は、現在そのグループに対してスキャンが有効です。

グループ名の前にチェックマークが付いていない場合は、現在そのグループに対してスキャンが無効です。

- 4  を押して目的のグループ名を選択します。

グループに対してスキャンが現在無効な場合は、ディスプレイに【ゆうこう】と表示されます。

グループに対してスキャンが現在有効な場合は、ディスプレイに【ていし】と表示されます。

- 5 表示されたオプション (【ゆうこう】または【ていし】) を選択し、 を押して選択します。

どのオプションを選択したかに応じて、【スキャンゆうこう】または【スキャンていし】が、確認のために一瞬ディスプレイに表示されます。



無線に、ゾーン スキャン リストが再度表示されます。グループのスキャンが有効な場合、グループ名の前にチェックマークが表示されます。グループのスキャンが無効な場合、グループ名の前のチェックマークは削除されます。



[メンバーついか] メニューからのグループの追加または削除

Connect Plus 無線機では、グループ番号やグループ エイリアスをゾーン スキャン リストに重複して掲載できず、"スキャンの候補"として表示することもできません。したがって、[ステップ 6](#)と [ステップ 7](#)に記載された"スキャンの候補"リストは、ゾーン スキャン リストからグループを追加または削除した後に、変わる場合があります。

スキャン リストを編集できるように無線機がプログラムされている場合、[メンバーついか] メニューを使用して、現在選択されているゾーンの スキャン リストにグループを追加できます。また、現在選択されているゾーンの スキャン リストからグループを削除できます。

- 1  を押してメニューにアクセスします を押します。



- 2  または  を押して【スキャン】オプションに移動し、 を押して選択します。

3  または  を押して **◀[メンバーをついか]** に移動し、 を押して選択します。

ディスプレイに、**[ゾーン n からメンバーをついか]** と表示されます (n は、現在選択しているゾーンと同じ **Network ID** を持つ無線機の最初の **Connect Plus** ゾーンの **Connect Plus** ゾーン番号です)。

4 次のいずれかを実行します。



- スキャンリストに追加するグループが、そのゾーン内でチャンネルセレクトタ位置に割り当てられている場合は、**ステップ 6** に進んでください。
 - スキャンリストに追加するグループが、別の **Connect Plus** ゾーン内でチャンネルセレクトタ位置に割り当てられている場合は、**ステップ 5** に進んでください。
-

5  または  を押して、現在選択しているゾーンと同じネットワーク ID を持つ、**Connect Plus** ゾーンのリストまでスクロールします。

6 目的のグループがチャンネルセレクトタ位置に割り当てられている **Connect Plus** ゾーンが見つかったら、 を押して選択します。

無線機に、そのゾーンでチャンネル位置に割り当てられているグループリストで最初のエントリが表示されます。そのリストのグループは、現在選択しているゾーンのスキャンリスト (またはすでにゾーンに存在するスキャンリスト) に追加できるため、"スキャンの候補" と呼びます。

スキャンリストに追加できるグループがゾーンにない場合、無線機に **[こうほなし]** と表示されます。

7  または  を押して、候補グループのリストをスクロールします。

グループエイリアスの直前のプラス記号 (+) は、そのグループが、現在選択しているゾーンのスキャンリスト内にあることを示しています。

エイリアスの直前にプラス記号 (+) が表示されない場合は、そのグループがスキャンリスト内になく、追加できることを示しています。

8 該当するグループエイリアスが表示されたら、 を押します。

このグループが現在選択しているゾーンのスカンリストにない場合は、【つか】(グループ エイリアス) メッセージが表示されます。

このグループが現在選択しているゾーンのスカンリストにすでに存在している場合は、【さくじよ】(グループ エイリアス) メッセージが表示されます。

9  を押して表示されたメッセージ (【つか】 または 【さくじよ】) を承諾します。

リストからグループを削除した場合は、エイリアスの直前にプラス記号 (+) が表示されなくなるので、操作が正常に完了したことがわかります。

リストにグループを追加した場合は、エイリアスの直前にプラス記号 (+) が表示されるので、操作が正常に完了したことがわかります。

グループを追加しようとして、リストがすでに一杯の場合は、無線機に【リストがまんぱい】と表示されます。この場合、新しいグループを追加する前に、スカンリストからグループを削除する必要があります。

10 終了したら、希望するメニューに戻るのに必要な回数だけ  を押します。

スカン動作の説明



注記:

異なるゾーンの無線機がゾーン スカン リスト メンバーの通話に参加し、応答する前に通話のコールハングタイマーの期限が切れた場合、応答するには、スカン リスト メンバーのゾーンとチャンネルに移動して、新しい通話を開始する必要があります。

スカンリストにあるグループに対する通話を聞き逃す場合があります。次のいずれかの理由で通話を聞き逃した場合、原因は無線機の問題ではありません。これは、**Connect Plus** の通常のスカン動作です。

- スカン機能がオンになっていない (ディスプレイにスカンアイコンがあるか確認してください)。
- スカン リスト メンバーがメニューから無効にされている (スカン リストの編集 ページ 262 を参照)。
- すでに通話に参加している。
- スカン グループのいずれのメンバーもサイトに登録されていない (マルチサイト システムのみ)。

トークバックのスカン

無線機が選択可能グループ スカン リストからの通話をスカンする場合にスカンされた通話の間に **PTT** ボタ

ンを押した場合、無線機の動作は、無線機のプログラミングの間にスキャントークバックが有効だったか無効だったかに応じて決まります。詳細については、ディーラーまたはシステム管理者にご確認ください。

スキャントークバック無効

無線機がスキャンされた通話を終了し、現在選択されているチャンネル位置の連絡先名に基づいて送信を行います。現在選択されている連絡先のコールハングタイムの期限が切れた後、無線機はホームチャンネルに戻り、スキャンハングタイムタイマーを開始します。スキャンハングタイムタイマーの期限が切れた後、無線機はグループスキャンを再開します。

スキャントークバック有効

スキャンされた通話のグループハングタイム中に **PTT** ボタンを押すと、無線機はスキャングループへの送信を試みます。



注記:

現在選択されているゾーン内のチャンネル位置に割り当てられていないグループに対する通話をスキャンしている際に、通話のハングタイムを逃した場合、適切なゾーンに切り替えてから、グループのチャンネル位置を選択し、そのグループにトークバックします。

グループの優先度の設定

優先度モニタ機能を使用すると、無線機は、別の通話中に優先度の高いグループからの通話を受信すると、自動的に通話を切り替えます。無線機が優先度の高い通話に切り替えるとき、トーンが鳴ります。グループの優先度には、**2**つのレベルがあります。P1 と P2 です。P1 が P2 よりも優先されます。





注記:

既定の緊急復帰グループ ID が **MOTOTRBO Connect Plus** オプション ボード **CPS** で設定されている場合、グループの優先度は次の **3**つのレベルになります: **P0**、**P1**、および **P2**。P0 は 永久緊急復帰グループ ID で最優先されます。詳細については、ディーラーまたはシステム管理者にご確認ください。



1



 を押してメニューにアクセスします。



2



 または  を押して【スキャン】に移動し、 を押して選択します。

3

 または  を押して【リストへんしゅう】に移動し、 を押して選択します。

4  または  を押して必要なグループに移動し、 を押して選択します。

5  または  を押して『ゆうせんど』に移動し、 を押して選択します。

6  または  を押して必要な優先度に移動し、 を押して選択します。

ディスプレイにポジティブミニ通知が表示された後、前の画面に戻ります。優先度を示すアイコンはグループの左側に表示されます。

連絡先設定



注記:

Connect Plus 連絡先の無線機 ID の追加または編集を行うことができます。無線機 ID の削除は、ディーラーのみが実行できます。

あるチャンネルで秘話モード機能が有効であれば、そのチャンネルで、秘話対応音声コールを行えます。無線機と同一のプライバシーキー、または同一のキー値とキー ID が設定された相手の無線機のみが、送信のスクランブルを解除できます。

連絡先リストへのアクセスは、ゾーン設定によって異なります。

- 無線機で設定されているゾーンが 1 つのみの場合は、現在選択されているゾーンから直接、連絡先リストが表示されます。
- 無線機で複数のゾーンが設定されている場合は、現在選択されているゾーンと同じネットワーク ID を持つすべてのゾーンが、ゾーン連絡先フォルダに表示されます。ユーザーはそれらのゾーンの連絡先にアクセスできません。





連絡先は、無線機の「アドレス帳」機能になります。各エントリは、通話を開始するときに使用するエイリアスまたは ID に対応します。

ゾーンごとに、最大 **100** 件の連絡先に関する連絡先リストが提供されます。次の連絡先タイプを使用できます。

- 個別コール
- グループ通話
- マルチグループ コール
- サイト一斉コール音声
- サイト一斉コール テキスト
- [ディスパッチ コール]

連絡先タイプのディスパッチ コールは、サードパーティのテキスト メッセージ サーバーを介して、ディスパッチャ PC にテキスト メッセージを送信するために使用されます。

連絡先からの個別コール発信

- 1  を押してメニューにアクセスします を押します。
- 2  または  を押して [れんらくさき] に移動し、 を押して選択します。

エント리는アルファベット順にソートされます。



- 3 無線機を口から **1 ~ 2** インチ (**2.5 ~ 5.0 cm**) の場所に保持します。
- 4 **PTT** ボタンを押して通話を発信します。
LED が緑色で点灯します。
- 5 通話許可トーンが完了するまで待機し (有効な場合)、マイクに向かってはっきりと話します。
- 6 相手の声を聞くには、**PTT** ボタンを放します。
相手先無線機が応答すると **LED** は緑色で点滅し、ディスプレイに送信ユーザーの **ID** が表示されます。
音声アクティビティがないまま、事前に定められた時間が経過すると、通話が終了します。
短いトーンが聞こえます。ディスプレイに [コール しゅうりょう] と表示されます。



エイリアス検索による通話発信

エイリアスや英数字検索を使用して、必要な無線機のエイリアスを取得することもできます。

この機能は、[れんらくさき]のみに適用されます。

- 1  を押してメニューにアクセスします を押します。

- 2  または  を押して [れんらくさき] に移動し、 を押して選択します。
エント리는アルファベット順にソートされます。

- 3 許可されたエイリアスの最初の文字を入力し、
または  を押して、必要なエイリアスを選択します。

- 4 無線機を口から 1 ~ 2 インチ (2.5 ~ 5.0 cm) の場所に保持します。

- 5 **PTT** ボタンを押して通話を発信します。
LED が緑色で点灯します。宛先のエイリアスが表示されます。

- 6 通話許可トーンが完了するまで待機し (有効な場合)、マイクに向かってはっきりと話します。

- 7 相手の声を聞くには、**PTT** ボタンを放します。



ターゲットの無線機が応答すると、LED が緑色に点滅します。



音声アクティビティがないまま、事前に定められた時間が経過すると、通話が終了します。





ディスプレイに【コールしゅうりょう】と表示されます。

新規連絡先の追加

- 1  を押してメニューにアクセスします を押します。

- 2  または  を押して [れんらくさき] に移動し、 を押して選択します。

- 3  または  を押して [しんき とうろく] に移動し、 を押して選択します。













- 4 キーパッドを使用して連絡先番号を入力し、 を押して確認します。
- 5 キーパッドを使用して連絡先の名前を入力し、 を押して確認します。
- 6 連絡先を追加する場合は、 または  を押して必要な着信音タイプに移動し、 を押して選択します。
無線機からはポジティブ インジケータ トーンが聞こえ、ディスプレイに「れんらくさきほぞんずみ」と表示されます。





通話インジケータ設定





この機能を使用すると、無線機ユーザーが通話やテキストメッセージの着信音を設定できます。

ページング用着信音のオンとオフの切り替え

受信ページングの着信音を選択したり、オンとオフを切り替えることができます。





- 1  を押してメニューにアクセスします を押します。
- 2  または  を押して「せってい」に移動し、 を押して選択します。
- 3  または  を押して「きのうせってい」に移動し、 を押して選択します。
- 4  または  を押して「トーンアラート」に移動し、 を押して選択します。
- 5  または  を押して「ちやくしんおん」に移動し、 を押して選択します。



- 6  または  を押して【ページング】に移動し、 を押して選択します。
現在のトーンは、 で示されます。



- 7  または  を押して必要なトーンに移動し、 を押して選択します
 選択したトーンの隣に  が表示されます。



個別コール用着信音のオンとオフの切り替え



受信した個別コールの着信音のオンとオフを切り替えられます。

- 1  を押してメニューにアクセスします  を押します。
- 2  または  を押して【せってい】に移動し、 を押して選択します。

- 3  または  を押して【きのうせってい】に移動し、 を押して選択します。

- 4  または  を押して【トーンアラート】に移動し、 を押して選択します。

- 5  または  を押して【ちやくしんおん】に移動し、 を押して選択します。

- 6  または  を押して【こべつコール】に移動し、 を押して選択します。

- 7  を押して、個別コールの着信音をオンまたはオフにします。



個別コールの着信音がオンの場合は、【ゆうこう】の隣に  が表示されます。



個別コールの着信音がオフの場合、 は表示されません。



テキスト メッセージ用着信音のオンとオフの切り替え



受信したテキスト メッセージの着信音のオンとオフを切り替えられます。





- 1  を押してメニューにアクセスします を押します。





- 2  または  を押して [せってい] に移動し、
 を押して選択します。

- 3  または  を押して [きのうせってい] に移動し、
 を押して選択します。

- 4  または  を押して [トーン/アラート] に移動し、
 を押して選択します。

- 5  または  を押して [ちやくしんおん] に移動し、
 を押して選択します。

- 6  または  を押して [テキスト メッセージ] に移動し、
 を押して選択します。
現在のトーンは、 で示されます。

- 7  または  を押して必要なトーンに移動し、
 を押して選択します
 選択したトーンの隣に  が表示されます。

アラート タイプの選択



注記:

プログラムされた [アラートタイプ] ボタンがディーラーまたはシステム管理者によって割り当てられます。無線機がどのようにプログラムされているかについては、ディーラーまたはシステム管理者に確認してください。

無線機通話を、事前設定したマナー通話となるようにプログラムできます。[ぜんトーン] ステータスが無効である場合、[ぜんトーンしょうおん] アイコンが表示されます。[ぜんトーン] ステータスが有効である場合、関連するアラート音タイプが表示されます。

瞬時着信音スタイルである場合は、バイブが1回振動します。繰り返し着信音スタイルである場合は、バイブが繰り返して動作します。[着信音とバイブ]に設定されている場合、受信トランザクション（ページング、メッセージなど）があると、特定の着信音が鳴ります。これは、ポジティブインジケータ トーンや不在着信の音に似ています。

警告トーンの音量を上げる

無線機通話に応答がない状態が続くと継続的に警告を発するよう、無線機をプログラムできます。時間が経つにつれて、アラーム トーンは自動的に大きくなります。この機能はステップアラートとして知られています。

通話履歴

無線機は、最近の発信、応答、不在の個別コールをすべて記録します。コールログ機能を使用し、最近の通話を表示して管理します。



各通話リストでは次のタスクを実行できます。



- 削除
- 詳細の表示



最近の通話の表示

リストは【ふざいちゃくしん】、【へんとうずみ】、および【はっしん】です。

- 1  を押してメニューにアクセスします を押します。



- 2  または  を押して【つうわ りれき】に移動し、 を押して選択します。



- 3  または  を押して優先リストに移動し、 を押して選択します。
ディスプレイには、最近のエントリがリストの最初に表示されます。

- 4  または  を押してリストを表示します。
PTT ボタンを押して、現在選択されているエイリアスまたは ID に個別コールを開始します。



通話リストからの通話の削除



1  を押してメニューにアクセスします を押します。

2  または  を押して [つうわ りれき] に移動し、 を押して選択します。





3  または  を押して必要なリストに移動し、 を押して選択します。

通話リストを選択してもエントリがなければ、ディスプレイに [リストにありません] と表示され、キー操作音がオンであれば低いトーンが鳴ります。

4  または  を押して必要なエリアまたは ID に移動し、 を押して選択します。



5  または  を押して [さくじょ] に移動し、 を押して選択します。



6 以下のいずれか 1 つの手順を実行します。



-  を押して [はい] を選択してエントリを削除します。ディスプレイに [にゅうりよくさくじょ済み] と表示されます。
 -  または  を押して [いいえ] に移動し、 ボタンを押します を押して前の画面に戻ります。
-



通話リストからの詳細の表示

1  を押してメニューにアクセスします を押します。

2  または  を押して [つうわ りれき] に移動し、 を押して選択します。

3  または  を押して必要なリストに移動し、 を押して選択します。

4  または  を押して必要なエリアまたは ID に移動し、 を押して選択します。

5  または  を押して [しようさい] に移動し、 を押して選択します。
ディスプレイに、通話リストの詳細が表示されます。

ページング操作

ページング機能により、相手が応答できる状態になったらかけ直すよう、特定の無線機ユーザーに警告できます。

この機能は、メニューから連絡先、ダイアル、またはプログラムされた [ワンタッチアクセス] ボタンを使用してアクセスできます。

ページングへの応答

下記の手順に従って、無線機でページングに応答します。

ページングを受信した場合:

- 反復トーンが鳴ります。
- 黄色の LED が点滅します。

- ディスプレイに通知リストが表示され、ページングとともに、呼び出し元無線機のエリアまたは ID が示されます。



ディーラーまたはシステム管理者の設置に応じて、以下の 1 つを行うことによりページングに応答できます。

- **PTT** ボタンを押し、個別コールを使って発信者に直接応答します。
- **PTT** ボタンを押し、通常のグループ通信を続けます。
ページングは通話履歴メニューの不在着信履歴オプションに移動します。不在着信履歴から発信者に応答できます。







詳しくは、「[通知リスト ページ 190](#)」および「[通話履歴機能 ページ 126](#)」を参照してください。



連絡先リストからのページングの発信

- 1  を押してメニューにアクセスします を押します。

2  または  を押して [れんらくさき] に移動し、  を押して選択します。

3 次に説明するいずれか 1 つの手順を使用して、必要な無線機のエイリアスまたは ID を選択します。

- 無線エイリアスを直接選択します。
 -  または  を押して必要な無線エイリアスに移動し、  を押して選択します。
- [ダイヤル] メニューを使用します。
 -  または  を押して [ダイヤル] に移動し、  を押して選択します。
 - ダイアルのテキスト入力画面が表示されます。無線機 ID を入力し、  を押します。

4  または  を押して [ページング] に移動し、  を押して選択します。

ディスプレイに [ページング:] と表示されます。ディスプレイに [<無線機のエイリアスまたは ID >]

[ページング] と無線機のエイリアスまたは ID が表示され、ページングが送信されたことが示されます。

無線機がページングを送信している間は緑色の LED が点灯します。

ページングの確認応答を受信すると、ディスプレイに [ページングかんりょう] と表示されます。

ページングの確認応答を受信しなかった場合は、ディスプレイに [ページングしっぱい] と表示されません。

ワンタッチ アクセス ボタンを使用したページング

プログラムされたワンタッチ アクセス ボタンを押して、事前に定義されたエイリアスにページングを発信します。

ディスプレイには [ページング] と無線機のエイリアスまたは ID が表示され、ページングが送信されたことが示されます。

無線機がページングを送信している間は緑色の LED が点灯します。

ページングの確認応答を受信すると、ディスプレイに【ページングかんりょう】と表示されます。

ページングの確認応答を受信していない場合は、ディスプレイに【ページングしっぱい】と表示されません。

ミュートモード

ミュートモードでは、無線機のすべての音声インジケータを無音にすることができます。

ミュートモード機能を開始すると、緊急操作などの優先度の高い機能を除くすべての音声インジケータがミュートされます。

ミュートモードを終了すると、無線機で、継続中のトーンおよび音声の再生が再開されます。



注記:

これは購入可能な機能です。詳細については、ディーラーまたはシステム管理者にご確認ください。

ミュートモードの有効化

下記の手順に従って、ミュートモードを有効にします。

この機能には、プログラムされた【ミュートモード】ボタンからアクセスします。













ミュートモードを有効にすると、次のことが発生します。

- ポジティブインジケータトーンが鳴ります。
- ディスプレイに【ミュートモードオン】と表示されます。
- 赤色のLEDライトの点滅が開始し、ミュートモードが終了するまで点滅したままになります。
- ディスプレイのホーム画面に【ミュートモード】アイコンが表示されます。
- 無線機がミュートになります。
- ミュートモードタイマーが、設定された時間のカウントダウンを開始します。

ミュートモードタイマーの設定

ミュートモードタイマーを設定すると、事前設定した所定の時間の間、ミュートモード機能を有効にすることができます。タイマーの時間は、無線機メニューで0.5 ~ 6時間の範囲内に設定できます。ミュートモードは、タイマーの時間が切れると終了します。

タイマーを0のままにすると、プログラムされた【ミュートモード】ボタンを押すまで、無線機は無期限にミュートモードになります。

- 1  を押してメニューにアクセスします。
- 2  または  を押して【せってい】に移動します。  を押して選択します。
- 3  または  を押して【きのうせってい】に移動します。  を押して選択します。
- 4  または  を押して【ミュート タイマー】に移動します。  を押して選択します。
- 5  または  を押して各桁の数値を編集し、  を押します。

ミュートモードの終了

この機能は、ミュートモードタイマーの時間が切れると、自動的に終了します。

ミュートモードを手動で終了するには、次のいずれかの操作を実行します。

- プログラムされた【ミュートモード】ボタンを押します。
- 任意のエントリで **PTT** ボタンを押します。

ミュートモードを無効にすると、次のことが発生します。

- ネガティブインジケータトーンが鳴ります。
- ディスプレイに【ミュートモード オフ】と表示されません。
- 点滅する赤いLEDが消灯します。
- ホーム画面から【ミュートモード】アイコンが消えます。
- 無線機のミュートが解除され、スピーカーが元の状態に戻ります。
- タイマーの時間が切れていない場合、ミュートモードタイマーが停止します。

**注記:**

ユーザーが音声を送信した場合や、プログラムされていないチャンネルに切り替えた場合も、ミュートモードは終了します。

緊急操作

**注記:**

サイレントまたは音声付きサイレントでの緊急の開始がプログラムされている無線機では、通常は、緊急コールまたは緊急アラートが終了すると、サイレント動作が自動的に終了します。このルールの例外は、緊急モードに緊急アラートが構成されており、緊急タイプにサイレントが構成されている場合です。無線機がこのようにプログラムされている場合は、**PTT** を押すか、緊急オフ用に構成されているボタンを押してサイレント動作をキャンセルするまで、サイレント動作が続行されます。

Connect Plus の自動フォールバック モードで動作する場合、緊急音声コールと緊急アラートはサポートされていません。詳細については、「[自動フォールバック ページ 254](#)」を参照してください。

重大な状況を示すために、緊急アラートが使われます。いつでも、どの画面でも、現在のチャンネルでアクティビティがある場合であっても、緊急操作を開始できます。**[緊急]** ボタンを押すと、プログラムされた緊急モードが開始され

ます。プログラムされた緊急モードは、オプションのマンダウン機能をトリガすることで開始することもできます。緊急機能は、無線機で無効にされている場合があります。

ディーラーは、プログラムされた **[緊急]** ボタンの押し下げ時間を設定できます。ただし、他のボタンと同様、長押しは除きます。

短押し

0.05 秒から 0.75 秒の間

長押し

1.00 秒から 3.75 秒の間

緊急 ボタンには、緊急のオン/オフ機能が割り当てられています。**緊急** ボタンに割り当てられている操作については、ディーラーに確認してください。

- **緊急** ボタンの短押しに緊急モードのオンを割り当てると、**緊急** ボタンの長押しには緊急モードの終了が割り当てられます。
- **緊急** ボタンの長押しに緊急モードのオンを割り当てると、**緊急** ボタンの短押しには緊急モードの終了が割り当てられます。

Connect Plus ゾーンで選択されている場合、無線機では、**3 種類**の緊急モードをサポートします。

緊急通話

割り当てられた緊急タイムスロットで通話するには、**PTT** ボタンを押す必要があります。

音声ガイドおよび緊急コール

割り当てられた緊急タイムスロットでの最初の送信のためにマイクのミュートが自動的に解除され、**PTT** ボタンを押さずに通話できます。マイクは、無線機にプログラムされている期間、この方法で常時"ホット"になります。同じ緊急コールでさらに送信するには、**PTT** ボタンを押す必要があります。

緊急警告

緊急アラートは音声通話ではありません。このアラートを受信するように構成されている無線機に送信される緊急通知です。無線機は、現在登録されているサイトの制御チャンネルを使用して緊急アラートを送信します。この緊急アラートは、アラートを受信するようにプログラムされている **Connect Plus** ネットワークにある無線機によって受信されます (無線機が登録されているネットワークサイトを問わない)。

ゾーンごとに 1 種類の緊急モードのみを緊急ボタンに割り当てることができます。また、緊急モードには以下のタイプがあります。

レギュラー

無線機は緊急を開始し、音声インジケータと視覚的インジケータの両方またはいずれかを表示します。

サイレント

音声インジケータも視覚的インジケータも示さずに、無線機は緊急を開始します。無線機は、**PTT** ボタンを押して音声送信を開始するまで、緊急状況を示すすべての音声インジケータと視覚的インジケータを抑制します。

音声付きサイレント

何らかの音声送信でも無線機のミュートが解除される点を除きサイレント動作と同じです。

着信緊急の受信

無線機は、アラートトーンを鳴らすとともに、着信緊急についての情報も表示するようにプログラムされていることがあります。このようにプログラムされている場合、着信緊急を受信すると、**[Emergency Details]**(きんきゅうしょうさい) 画面がただちにディスプレイに表示されます。緊急アイコン、緊急を要求した無線機のエイリアスまたは ID、緊急時に使用されるグループ連絡先、および追加情報行 1 行も表示されます。追加情報は、グループの連絡先が含まれているゾーン名です。

現時点では、無線機には最後にデコードされた緊急だけが表示されます。前の緊急がクリアされる前に新しい緊急を受信した場合、新しい緊急詳細が、前の緊急詳細に置き換わります。

無線機がどのようにプログラムされているかによっては、緊急が終了した後でも、無線機のディスプレイには [Emergency Details](きんきゅうしょうさい) 画面 (または [アラーム リスト] 画面) が表示されたままになります。次のセクションで説明するように、[アラーム リスト] に緊急詳細を保存したり、緊急詳細を削除したりできます。



緊急詳細のアラーム リストへの保存

緊急詳細をアラーム リストに保存すると、メイン メニューから [アラーム] を選択することで、後で詳細を再度表示できます。

- 1 [緊急詳細] (または [アラーム]) 画面が表示されている間に、 を押します。

[がいぶアラーム リスト] 画面が表示されます。

- 2 下記の作業のどちらかを実行します。



- [はい] を選択して  を押して、アラーム リストに緊急詳細を保存し、[緊急詳細] (または [アラーム]) 画面を終了します。
- [いいえ] を選択して  を押して、[緊急詳細] (または [アラーム]) 画面に戻ります。

緊急詳細の削除

- 1 [緊急詳細] 画面が表示されている間に、 を押します。

[さくじょ] 画面が表示されます。

- 2 下記の作業のどちらかを実行します。

- [はい] を選択して  を押すと、緊急詳細が削除されます。
- [いいえ] を選択して  を押すと、[緊急詳細] 画面に戻ります。

緊急コールへの応答



注記:

緊急コールハング タイムに割り当てられた時間内に緊急コールに応答しない場合、緊急コールは終了します。緊急コールハング タイムが期限切れになった後グループと通話する場合、最初にそのグループに割り当てられたチャンネル位置を選択します (まだ選択されていない場合)。次に **PTT** を押して、グループに対して非緊急コールを開始します。

1 緊急アラームを受信すると、任意のボタンを押してすべての緊急アラームの受信通知を停止します。

2 **PTT** ボタンを押して緊急グループでの音声送信を開始します。

このグループをモニタしているすべての無線機が、この送信を受信します。

3 通話許可トーンが完了するまで待機し (有効な場合)、マイクに向かってはっきりと話します。

LED が緑色に点灯します。

4 相手の声を聞くには、**PTT** ボタンを放します。

緊急を通知した無線機が応答すると、緑色の **LED** が点滅します。ディスプレイに、グループコールのアイコン、グループ ID、および送信無線機の ID が表示されます。

緊急アラートへの応答



注記:

緊急アラートに使われるグループ連絡先は、音声通信には使用しないでください。この操作を実行すると、他の無線機が同じグループに関する緊急アラートを送受信できなくなります。

無線機からの緊急アラートは、ユーザーが緊急状況にあることを示します。緊急事態を宣言した無線機への個別コールを開始する、該当するトークグループへのグループコールを開始する、該当する無線機にページングを送信する、無線機のリモートモニタを開始するなどによって、アラートに対応できます。適切な対応は、組織によって、および個々の状況によって決まります。

緊急復帰コールを無視

この機能拡張は、無線機が、アクティブな緊急復帰コールを無視するためのオプションを提供します。

緊急復帰コールを無視できるようにするには、無線機を **Connect Plus Customer Programming Software (CPCPS)** で設定する必要があります。

この機能が有効になっていると、無線機は緊急通話表示を行いません。また既定の緊急復帰グループ ID で音声を受信しません。

詳細については、ディーラーまたはシステム管理者にご確認ください。

緊急コールの開始



注記:

無線機がサイレントに設定されている場合、緊急モード中は、**PTT** ボタンを押して音声送信を開始するまでは、音声インジケータも視覚的インジケータも表示されません。

無線機が音声付きサイレントに設定されている場合、当初、無線機が緊急モードであることを示す音声インジケータも視覚的インジケータも示されません。ただし無線機は、緊急コールに応答する無線送信のためにミュート解除されます。緊急インジケータは、無線機から音声送信を開始するために **PTT** ボタンを押した後にのみ表示されます。

"サイレント" と "音声付きサイレント" の両方の動作で、緊急コールが終了すると、無線機はサイレント動作を自動的に終了します。

- 1 プログラムされた **[緊急]** ボタンを押します。
- 2 **PTT** ボタンを押して緊急グループでの音声送信を開始します。

PTT ボタンを放すと、[きんきゅうコールハングタイム] に指定した期間、緊急コールが続行されます。

この期間に **PTT** ボタンを押した場合、緊急コールは続行されます。

音声ガイド付き緊急コールの開始

無線機がこのタイプの動作用にプログラムされている必要があります。

この動作を有効にしてある場合、プログラムされた **[緊急]** ボタンを押して無線機がタイムスロットの割り当てを受け取ると、マイクは **PTT** ボタンを押さなくても自動的にアクティブになります。このアクティブな状態のマイクを「ホットマイク」と呼びます。「ホットマイク」は、緊急コールの間にお使いの無線機からの最初の音声送信に適用されます。同じ緊急コールでさらに送信するには、**PTT** ボタンを押す必要があります。

- 1 プログラムされた **[緊急]** ボタンを押します。
- 2 マイクは、無線機コードプラグプログラミングで指定されている "ホットマイク" 時間の間、アクティブなままになります。
この期間、LED が緑色で点灯します。

- 3 プログラムされた持続時間よりも長く通話するには、**PTT** ボタンを押し続けます。
-

緊急アラートの開始



注記:

"サイレント"または"音声付きサイレント"での緊急の開始がプログラムされている無線機では、緊急アラートの送信中に音声による通知も視覚的な通知も示されません。"サイレント"がプログラムされている無線機では、**PTT** を押すか、[きんきゅうオフ]が設定されたボタンを押すまで、サイレント動作がいつまでも続行されます。"音声付きサイレント"がプログラムされている場合、サイト コントローラが緊急アラートをブロードキャストすると、無線機はサイレント動作を自動的にキャンセルします。

オレンジの **緊急** ボタンを押します。

緊急アラートをサイト コントローラに送信すると、緊急アイコン、緊急アラートに対して使われるグループ連絡先、および [T× アラーム] が無線機のディスプレイに表示されます。

緊急アラートが正常に送信されて他の無線機で受信するようにブロードキャストされると、ポジティブ インジケータ

トーンが鳴り、無線機に [アラーム そうしん] と表示されます。緊急アラートに失敗すると、ネガティブ インジケータトーンが鳴り、無線機に [アラーム NG] と表示されます。

緊急モードの終了



注記:

緊急ハング タイムの期限切れが原因で緊急コールが終了する一方で、緊急状況が終わっていない場合は、**緊急** ボタンを再度押してプロセスをやり直します。

プログラムされた **緊急** ボタンを押して緊急アラートを開始すると、**Connect Plus** システムから応答を受信した後、無線機は自動的に緊急モードを終了します。

プログラムされた **緊急** ボタンを押して緊急コールを開始すると、利用可能になったチャンネルが無線機に自動的に割り当てられます。緊急を示すメッセージが無線機から送信された後は、緊急コールをキャンセルできません。一方、ボタンを間違えて押すか、緊急事態が存在しなくなった場合に、割り当てられたチャンネルを介して、このことを伝える必要がある場合があります。**PTT** ボタンを離すと、緊急コールハング タイムの期限が切れた後で緊急コールが終了します。

無線機に音声ガイド付き緊急が構成されていた場合は、"ホット マイク" 期間を使用して誤操作について説明し、**PTT**

ボタンを押してから離して送信を終了します。緊急コールは、緊急コールハングタイムの期限が切れると終了します。

テキスト メッセージング

無線機は、他の無線機やテキスト メッセージ アプリケーションからテキスト メッセージなどのデータを受信できます。

テキスト メッセージには、デジタル車載型無線機 (DMR) ショート テキスト メッセージと、テキスト メッセージの 2 種類があります。DMR ショート テキスト メッセージの最大長は 23 文字です。テキスト メッセージの最大長は、件名を含めて 280 文字です。件名は、電子メールアプリケーションからメッセージを受信した場合にのみ表示されます。



注記:







この最大長は、ソフトウェアとハードウェアが最新のモデルにのみ適用されます。ソフトウェアやハードウェアが古い無線機モデルでは、最大長は 140 文字です。詳細については、ディーラーまたはシステム管理者にご確認ください。

クイック テキスト メッセージの送信

無線機では、ディーラーがプログラミングするクイック テキスト メッセージを最大 10 まで使用できます。

クイック テキスト メッセージは事前定義されていますが、送信前に各メッセージを編集できます。

メッセージを送信する場合は、以下を実行して受信者を選択します。

-  または  を押して必要なエイリアスに移動し、 を押して選択します。
-  または  を押して【ダイアル】に移動し、 を押して選択します。ディスプレイの 1 行目に【ばんごう:】と表示されます。ディスプレイの 2 行目に、点滅するカーソルが表示されます。無線機のエイリアスまたは ID を入力し、 を押します。

ディスプレイに【メッセージそうしんちゆう】と表示され、メッセージが送信中であることが示されます。

メッセージが正常に送信されると、トーンが鳴り、ディスプレイに【メッセージそうしんずみ】と表示されます。

メッセージを送信できない場合、低いトーンが鳴り、ディスプレイに【メッセージそうしんしっぱい】と表示されます。

メッセージの送信が失敗すると、【さいそうしん】オプション画面に戻ります（「[送信に失敗したテキストメッセージの管理 ページ 289](#)」を参照）。

ワンタッチ アクセス ボタンを使用したクイック テキスト メッセージの送信

ディーラーがプログラムしたプログラム可能ボタンでクイック テキスト メッセージを送信できます。

プログラムされた **【ワン タッチ アクセス】** ボタンを押し、事前に定義されたクイック テキスト メッセージを、事前に定義されたエイリアスに送信します。

ディスプレイに【メッセージそうしんちゆう】と表示され、メッセージが送信中であることが示されません。

メッセージが送信されると、トーンが鳴り、ディスプレイに【メッセージそうしんずみ】と表示されます。

メッセージを送信できない場合、低いトーンが鳴り、ディスプレイに【メッセージそうしんしっぱい】と表示されません。

メッセージの送信が失敗すると、【さいそうしん】オプション画面に戻ります（「[送信に失敗したテキスト メッセージの管理 ページ 289](#)」を参照）。

下書きフォルダへのアクセス

下書きフォルダは、最大で **10** 件の最近保存されたメッセージを格納します。フォルダが一杯であるときにテキスト メッセージを保存すると、フォルダの一番古いテキスト メッセージが削除されます。

**注記:**

保存されたテキストメッセージを送信前に編集できます。キーパッドマイクでのみ使用できます（「保存されたテキストメッセージの編集と送信 ページ 287」参照）。 を長く押しすと、いつでもホーム画面に戻ります。

保存されたテキストメッセージの表示

- 1 テキストメッセージ機能にアクセスします。

無線機コントロール	手順
プログラムされた【メッセージ】ボタン	プログラムされた【メッセージ】ボタンを押します。
メニュー	a を押してメニューにアクセスします を押します。



無線機コントロール 手順

b または を押して【メッセージ】に移動し、 を押して選択します。





- 2 または を押して【したがり】に移動し、 を押して選択します。
- 3 または を押して必要なメッセージに移動し、 を押して選択します。

保存されたテキストメッセージの編集と送信

- 1 メッセージの表示中に、 を再度押します。



- 2  または  を押して【へんしゅう】に移動し、 を押して選択します。
点滅するカーソルが表示されます。

- 3 キーパッドを使用してメッセージを入力します。

 を押して、スペース 1 つ分左側に移動します。▶
または  キーを押すと、スペース 1 つ分右側に移動します。不要な文字を削除するときは、 キーを押します。 を長押しすると、テキスト入力方法が変更されます。

- 4 メッセージが完成したら、 を押します。

- 5 以下の方法でメッセージ受信者を選択します。

-  または  を押して必要なエイリアスに移動し、 を押して選択します。
-  または  を押して【ダイアル】に移動し、 を押して選択します。ディスプレイの

1 行目に【ばんごう:】と表示されます。ディスプレイの 2 行目に、点滅するカーソルが表示されます。無線機のエイリアスまたは ID を入力し、

 を押します。

ディスプレイに【メッセージそうしんちゆう】と表示され、メッセージが送信中であることが示されます。





メッセージが正常に送信されると、トーンが鳴り、ディスプレイに【メッセージそうしんずみ】と表示されます。



メッセージを送信できない場合、低いトーンが鳴り、ディスプレイに【メッセージそうしんしっぱい】と表示されます。



テキストメッセージが送信できない場合、そのメッセージは送信済みアイテムフォルダに移動し、送信失敗アイコンのマークが表示されます。



下書きフォルダからの保存されたテキストメッセージの削除

- 1 テキストメッセージ機能にアクセスします。

無線機コントロール	手順
プログラムされた【メッセージ】ボタン	プログラムされた【メッセージ】ボタンを押します。
メニュー	<p>a  を押してメニューにアクセスします を押します。</p> <p>b  または  を押して【メッセージ】に移動し、 を押して選択します。</p>

2  または  を押して【したがき】に移動し、 を押して選択します。

3  または  を押して必要なメッセージに移動し、 を押して選択します。

4  または  を押して【さくじょ】に移動し、 を押してテキストメッセージを削除します。

送信に失敗したテキストメッセージの管理

【さいそうしん】オプション画面では、以下のいずれかのオプションを選択できます。

- さいそうしん
- てんそう
- へんしゅう

テキストメッセージの再送信







 を押して、同じ無線機/グループのエイリアスまたは ID に同じメッセージを再送信します。

メッセージが送信されると、トーンが鳴り、ディスプレイにポジティブミニ通知が表示されます。

メッセージが送信されない場合、ディスプレイにネガティブミニ通知が表示されます。

テキスト メッセージの転送

別の無線機/グループのエイリアスまたは ID にメッセージを送信するには、【てんそう】を選択します。

- 1  または  を押して【てんそう】に移動し、
 を押して選択します。
- 2 メッセージ受信者を選択するには、 または
 を押して必要なエイリアスまたは ID に切り替え、
 を押して選択します。

ディスプレイに【メッセージそうしんちゅう】と表示され、メッセージが送信中であることが示されます。

メッセージが正常に送信されると、トーンが鳴り、ディスプレイに【メッセージそうしんずみ】と表示されます。

メッセージを送信できない場合、低いトーンが鳴り、ディスプレイに【メッセージそうしんしっぱい】と表示されます。

送信済みテキスト メッセージの管理

別の無線機に送信されたメッセージは、【そうしん BOX】に保存されます。最近送信されたテキスト メッセージは、必ず送信済みアイテム リストの一番上に追加されます。

送信 BOX フォルダは、最大で 30 件の最近送信されたメッセージを格納できます。フォルダが一杯であるときにテキスト メッセージを送信すると、置き換えとして、フォルダの一番古いテキスト メッセージが自動的に削除されます。







注記:



 を長く押すと、いつでもホーム画面に戻ります。



送信済みテキスト メッセージの表示

- 1 テキスト メッセージ機能にアクセスします。

無線機コントロール	手順
プログラムされた【メッセ	プログラムされた【メッセージ】ボタンを押します。

無線機コントロール 手順	
ページ] ボタン	
メニュー	<p>a  を押してメニューにアクセスします を押します。</p> <p>b  または  を押して【メッセージ】に移動し、 を押して選択します。</p>

2  または  を押して【そうしん BOX】に移動し、 を押して選択します。

3  または  を押して必要なメッセージに移動し、 を押して選択します。

画面の右上隅のアイコンは、メッセージのステータスを示します（「送信 BOX アイコン ページ 234」を参照）。

送信済みテキスト メッセージの送信

送信済みテキスト メッセージを表示中、以下のいずれかのオプションを選択できます。

- さいそうしん
- てんそう
- へんしゅう
- 削除

1 メッセージの表示中に、 を再度押します。

2  または   を押して選択します を押して、次のオプションのいずれかに移動して、

オプション 手順	
てんそう	別の加入者/グループのエイリアスまたは ID に選択したメッセージを送信するには、【てんそう】を選択します（「テキスト メッセージの転送 ページ 290」を参照）。

オプション	手順
削除	テキストメッセージを削除するには、【さくじょ】を選択します。
さいそうしん	<p>選択したテキストメッセージを同じ無線機/グループのエイリアスまたは ID に再送信するには、【さいそうしん】を選択します。</p> <p>同じメッセージが同じターゲット無線機に送信されていることが確認され、ディスプレイに【メッセージそうしんちゅう】と表示されます。</p> <p>メッセージが正常に送信されると、トーンが鳴り、ディスプレイに【メッセージそうしんずみ】と表示されます。</p> <p>メッセージを送信できない場合、低いトーンが鳴り、ディスプレイに【メッセージそうしんしっぱい】と表示されます。</p> <p>メッセージの送信に失敗すると、無線機は【さいそうしん】オプション</p>

オプション	手順
	画面に戻ります。  を押して、同じ無線機/グループのエイリアスまたは ID にメッセージを再送信します。





メッセージ送信中にメッセージ送信画面を終了すると、表示や音声による通知なしで、送信 BOX フォルダ内のメッセージのステータスが更新されます。



送信 BOX 内のメッセージのステータスが更新される前に、無線機のモードが変更されたり電源がオフになったりすると、実行中のメッセージを完了できなくなり、そのメッセージには **【送信失敗】** アイコンが自動的に付けられます。

無線機では、同時に最大で **5 件の実行中メッセージ** を使用できます。この間、新しいメッセージを送信できなくなり、新しいメッセージには自動的に **【送信失敗】** アイコンが表示されます。



送信済みアイテム内のすべての送信済みテキストメッセージの削除

1 テキストメッセージ機能にアクセスします。







無線機コントロール	手順
プログラムされた【メッセージ】ボタン	プログラムされた【メッセージ】ボタンを押します。
メニュー	<p>a  を押してメニューにアクセスします を押します。</p> <p>b  または  を押して【メッセージ】に移動し、  を押して選択します。</p>

2  または  を押して【そうしん BOX】に移動し、  を押して選択します。

選択した【そうしん BOX】にテキストメッセージが存在しない場合、ディスプレイに【リストにありません】と表示され、キーパッド トーンがオンの場合は低いトーンが鳴ります。

3  または  を押して【ぜんさくじょ】に移動し、  を押して選択します。

4 次のいずれかを選択します。

-  または  を押して【はい】に移動し、  を押して選択します。ディスプレイにポジティブ ミニ通知が表示されます。
-  または  を押して【いいえ】に移動し、  を押して前の画面に戻ります。



テキスト メッセージの受信

無線機がメッセージを受信すると、ディスプレイに送信者のエイリアスまたは ID 付きの通知リストとメッセージアイコンが表示されます。

テキスト メッセージを受信すると、以下のいずれかのオプションを選択できます。

- 表示
- [Read Later](あとでひょうじ)
- 削除

テキスト メッセージの表示

- 1  または  を押して [よみますか?] に移動し、 を押して選択します。

[じゅしん BOX] 内の選択したメッセージが開きます。

- 2 以下のいずれか 1 つの手順を実行します。
 -  を押して [じゅしん BOX] に戻ります。

-  をもう一度押して、テキスト メッセージの返信、転送、または削除を行います。

受信済みテキスト メッセージの管理

受信トレイを使用してテキスト メッセージを管理します。受信トレイは最大で 30 件のメッセージを格納できます。

受信トレイ内のテキスト メッセージは、新しく受信した順番にソートされます。

無線機は、テキスト メッセージ用の以下のオプションをサポートします。

- 返信 (即時テキストを使用)
- てんそう
- 削除
- 全削除







注記:



チャンネル タイプが一致しない場合、受信メッセージの転送、削除、およびすべて削除のみを行えます。



 を長く押すと、いつでもホーム画面に戻ります。



【じゅしん BOX】のテキストメッセージの表示

- 1  を押してメニューにアクセスします を押し
ます。

- 2  または  を押して【メッセージ】に移動
し、  を押して選択します。





- 3  または  を押して【じゅしん BOX】に移
動し、  を押して選択します。









- 4  または  を押してメッセージを閲覧しま
す。

- 5 以下のいずれか 1 つの手順を実行します。
 -  を押して現在のメッセージを選択し、 
を再度押して、そのメッセージの返信、転送、削
除のいずれかを行います。
 - ホーム画面に戻るには、  を長押しします。

【じゅしん BOX】のテキストメッセージへの返信

- 1 テキストメッセージ機能にアクセスします。





無線機コ ントロー ル	手順
プログラ ムされた 【メッセ ージ】ボ タン	プログラムされた【メッセージ】ボ タンを押します。
メニュー	<p>a  を押してメニューにアクセ スします を押しします。</p> <p>b  または  を押して【メ ッセージ】に移動し、  を押 して選択します。</p>



- 2  または  を押して [じゅしん BOX] に移動し、 を押して選択します。
-
- 3  または  を押して必要なメッセージに移動し、 を押して選択します。
-
- 4 サブメニューにアクセスするには、 を再度押します。
-
- 5 キーパッドを使用してメッセージの書き込み/編集を行います。
-
- 6 メッセージが完成したら、 を押します。
 ディスプレイに [メッセージそうしんちゆう] と表示され、メッセージが送信中であることが示されます。
 メッセージが正常に送信されると、トーンが鳴り、ディスプレイに [メッセージそうしんずみ] と表示されます。
 メッセージを送信できない場合、低いトーンが鳴り、ディスプレイに [メッセージそうしんしっぱい] と表示されます。



メッセージを送信できない場合、無線機は [さいそうしん] オプション画面に戻ります (送信に失敗したテキストメッセージの管理 ページ 289 を参照)。

[じゅしん BOX] のテキストメッセージの削除



- 1 テキストメッセージ機能にアクセスします。



無線機コントロール	手順
プログラムされた [メッセージ] ボタン	プログラムされた [メッセージ] ボタンを押します。
メニュー	<p>a  を押してメニューにアクセスします を押します。</p> <p>b  または  を押して [メッセージ] に移動し、 を押して選択します。</p>

2  または  を押して【じゅしん BOX】に移動し、 を押して選択します。

3  または  を押して必要なメッセージに移動し、 を押して選択します。





4 サブメニューにアクセスするには、 を再度押します。



5  または  を押して【さくじょ】に移動し、 を押して選択します。

6  または  を押して【はい】に移動し、 を押して選択します。
ディスプレイに【メッセージさくじょずみ】と表示され、画面が受信 BOX に戻ります。



受信 BOX からのすべてのテキストメッセージの削除



1 テキストメッセージ機能にアクセスします。

無線機コントロール	手順
プログラムされた【メッセージ】ボタン	プログラムされた【メッセージ】ボタンを押します。
メニュー	<p>a  を押してメニューにアクセスします を押します。</p> <p>b  または  を押して【メッセージ】に移動し、 を押して選択します。</p>

- 2  または  を押して [じゅしん BOX] に移動し、 を押して選択します。

選択した [じゅしん BOX] にメッセージが存在しない場合、ディスプレイに [リストにありません] と表示され、キーパッドトーンがオンの場合は低いトーン (キー操作音のオンとオフの切り替え ページ 205 を参照) が鳴ります。

- 3  または  を押して [ぜんさくじよ] に移動し、 を押して選択します。

- 4  または  を押して [はい] に移動し、 を押してを選択します。

ディスプレイに [じゅしん BOX しょうきよずみ] と表示されます。

秘話モード

有効になっている場合、この機能は、ソフトウェアベースのスクランブルソリューションの使用により、不正なユー

ザーによる盗聴を防ぐのに役立ちます。送信のシグナリングおよびユーザー識別の部分はスクランブルされません。

秘話モード対応で送信するには、現在のチャンネルセレクト位置に秘話モードを設定する必要があります。ただし、秘話モードを設定していなくても受信はできます。秘話モード対応チャンネルセレクト位置で、無線機はクリアな (スクランブルされていない) 送信を引き続き受信できます。

無線機はスクランブル秘話モードをサポートします。

秘話対応の通話またはデータ送信のスクランブルを解除するには、送信側の無線機と同じキー値およびキー ID (スクランブル秘話モード用) を無線機にプログラムする必要があります。

無線機が別のキー値およびキー ID によるスクランブル通話を受信すると、何も聞こえません (スクランブル秘話)。

無線機に秘話モードのタイプが割り当てられている場合、無線機が緊急通話または緊急アラームを送受信している場合を除き、ホーム画面にセキュアアイコンまたは非セキュアアイコンが表示されます。

無線機が送信中の場合、緑色の LED が点灯します。無線機が秘話モード対応で受信中の場合は、緑色の LED が素早く点滅します。



次のいずれかの作業を実行して、この機能にアクセスできます。





- プログラムされた **[ひわモード]** ボタンを押して、秘話モードのオンとオフを切り替えます。
- 次の手順に従って無線機のメニューを使用します。



**注記:**

無線機のモデルによっては、秘話モード機能がサポートされないことがあります。詳細については、ディーラーまたはシステム管理者にご確認ください。

- 1  を押してメニューにアクセスします を押します。

- 2  または  を押して **[せってい]** に移動し、
 を押して選択します。

- 3  または  を押して **[きのうせってい]** に移動するか、
 または  を押して **[Connect Plus]** に移動し、
 を押して選択します。

- 4  または  を押して **[スクランブルひわ]** に移動します。

ディスプレイに **[オン]** と表示されている場合は、

 を押すと秘話モードが有効になります。選択の確認を表すメッセージが無線機に表示されます。

ディスプレイに **[オフ]** と表示されている場合は、

 を押すと秘話モードが無効になります。選択の確認を表すメッセージが無線機に表示されます。

無線機に秘話モードのタイプが割り当てられている場合、無線機が緊急アラートを送受信している場合を除き、ステータスバーにセキュアアイコンまたは非セキュアアイコンが表示されます。

プライバシー対応 (スクランブル) 通話の発信

プログラムされた **[ひわモード]** ボタンを使用するか、メニューを使用して、秘話モードをオンに切り替えます。秘話モード対応送信を送信するには、現在選択されているチャンネル位置で、秘話モード機能が有効になっている必要があります。現在選択されているチャンネル位置で秘話モードが有効にされている場合は、お使いの無線機から発信される

すべての音声送信がスクランブルされます。グループコール、マルチグループコール、スキャンされた通話間のトークバック、サイト一斉コール、緊急コール、個別コールが対象です。お使いの無線機と同じキー値とキーIDを持つ受信側無線機のみが、送信のスクランブルを解除できます。

セキュリティ

システム内の任意の無線機の有効、無効を切り替えられます。たとえば、盗難にあった無線機を無効にして使用できないようにし、無線機を回収したら有効にできます。









注記:

無線機の有効、無効の切り替えは、これらの機能が有効である無線機に限られます。詳細については、ディーラーまたはシステム管理者にご確認ください。









無線停止

- 1 次のいずれかの作業を実行して、この機能にアクセスします。

無線機コントロール	手順
無線停止ボタン	<p>a プログラムされた [無線停止] ボタンを押します。</p> <p>b  または  を押して必要なエイリアスまたは ID に移動し、 を押して選択します。</p>
無線機メニュー	<p>a  を押してメニューにアクセスしますを押します。</p> <p>b  または  を押して [れんらくさき] に移動し、 を押して選択します。エントリはアルファベット順にソートされます。</p> <p>c 次に説明するいずれか 1 つの手順を使用して、必要な無線機のエイリアスまたは ID を選択します。</p>





無線機コ
ントロー
ル

手順

- 必要なエイリアスまたは ID を直接選択します。
-  または  を押して必要なエイリアスまたは ID に移動し、 を押して選択します。
- [ダイヤル] メニューを使用します。
-  または  を押して [ダイヤル] に移動し、 を押して選択します。
-  または  を押して [むせん ID] に移動

無線機コ
ントロー
ル

手順

- し、 を押して選択します。
- ディスプレイの 1 行目に [むせん ID:] と表示されます。ディスプレイの 2 行目に、点滅するカーソルが表示されます。キーパッドを使用して無線機のエイリアスまたは ID を入力し、 を押します。
- d**  または  を押して [むせんていし] に移動し、 を押して選択します。

ディスプレイに [むせんていし: <[ターゲット エイリアスまたは ID] と表示され、LED が緑色で点灯します。

2 確認応答を待ちます。







成功すると、ポジティブインジケータトーンが鳴り、ディスプレイに【むせていしかんりょう】と表示されます。

成功しなかった場合は、ネガティブインジケータトーンが鳴り、ディスプレイに【むせていしっばい】と表示されます。

停止解除









1 次のいずれかの作業を実行して、この機能にアクセスします。

無線機コントロール	手順
停止解除ボタン	<p>a プログラムされた【停止解除】ボタンを押します。</p>

無線機コントロール	手順
	<p>b  または  を押して必要なエリアスまたは ID に移動し、  を押して選択します。</p>
無線機メニュー	<p>a  を押してメニューにアクセスしますを押します。</p> <p>b  または  を押して【れんらくさき】に移動し、 を押して選択します。エントリはアルファベット順にソートされます。</p> <p>c 次に説明する手順のいずれかを実行して、必要な無線機のエリアスまたは ID を選択します。</p> <ul style="list-style-type: none"> 必要なエリアスまたは ID を直接選択します。





無線
機コ
ント
ロー
ル

手順

-  または  を押して必要なエイリアスまたは ID に移動し、 を押して選択します。
- 【ダイアル】メニューを使用します。
-  または  を押して【ダイアル】に移動し、 を押して選択します。
-  または  を押して【むせん ID】に移動し、 を押して選択します。

無線
機コ
ント
ロー
ル

手順

- ディスプレイの 1 行目に【むせん ID:】と表示されます。ディスプレイの 2 行目に、点滅するカーソルが表示されます。キーパッドを使用して無線機のエイリアスまたは ID を入力し、 を押します。
- d  または  を押して【ていしかいじよ】に移動し、 を押して選択します。

ディスプレイに【ていしかいじよ: <【無線機のエイリアスまたは ID】と表示され、LED が緑色で点灯します。

2 確認応答を待ちます。

成功すると、ポジティブ インジケータ トーンが鳴り、ディスプレイに【ていしかいじょかんりよう】と表示されます。

成功しなかった場合は、ネガティブ インジケータ トーンが鳴り、ディスプレイに【ていしかいじょしつぱい】と表示されます。

Bluetooth 動作



注記:

CPS 経由で無効にされている場合、すべての Bluetooth 関連機能が無効になり、Bluetooth 機器データベースは消去されます。

この機能では、お使いの無線機と Bluetooth 対応デバイス (アクセサリ) を無線 Bluetooth 接続を介して連携させることができます。お使いの無線機では、Motorola Solutions 製および COTS (市販既製品) の両方の Bluetooth 対応デバイスをサポートしています。

Bluetooth は、直線距離 10 メートル (32 フィート) の範囲内で動作します。これは、無線機と Bluetooth 対応デバイスとの間に障害物が何もない場合の距離です。

無線機と Bluetooth 対応デバイスを遠く引き離れた場合、高い信頼性での動作は期待できません。



受信不良地域では、音声とトーン両方が "不明瞭" または "割れて" 聞こえるようになります。この問題を解決するには、無線機とブルートゥース対応デバイスを互いに近づけて (規定の 10 メートル/32 フィート以内)、明瞭な音声受信を再確立します。無線機の Bluetooth 機能の最高出力は、10 メートル/32 フィート範囲で 2.5mW (4dBm) です。





無線機は、異なる種類の Bluetooth 対応デバイスとの Bluetooth 接続を同時に 4 本までサポートできます。たとえば、ヘッドセットおよび PTT 専用デバイス (POD) は同時に接続できます。同じ種類の複数の Bluetooth 対応デバイスには、同時に接続できません。

Bluetooth 対応デバイスの全機能の詳細については、各デバイスのユーザー マニュアルを参照してください。









ブルートゥースのオン/オフの切り替え

- 1  を押してメニューにアクセスします を押します。

2  または  を押して [Bluetooth] に移動し、 を押して選択します。

3  または  を押して [ステータス] に移動し、 を押して選択します。
ディスプレイに [オン] と [オフ] が表示されます。
現在のステータスは  で示されます。

4 以下のいずれか 1 つの手順を実行します。



-  または  を押して [オン] に移動し、 を押して選択します。ディスプレイに [オン] と表示され、選択したステータスの左には  が現れます。
 -  または  を押して [オフ] に移動し、 を押して選択します。ディスプレイに [オフ] と表示され、選択したステータスの左には  が現れます。
-



Bluetooth デバイスのサーチと接続

サーチ動作中および接続動作中は、Bluetooth 対応デバイスの電源を切ったり、 を押ししたりしないでください。動作が取り消されます。



1 Bluetooth 対応デバイスの電源を入れ、ペアリングモードにします。Bluetooth 対応デバイスの『ユーザーマニュアル』を参照してください。





2 無線機で、 を押してメニューにアクセスしますを押します。



3  または  を押して [Bluetooth] に移動し、 を押して選択します。

4  または  を押して [デバイス] に移動し、 を押して選択します。

5 以下のいずれか 1 つの手順を実行します。

-  または  を押して必要なデバイスに移動し、 を押して選択します。

- または  または  を押して【デバイスサーチ】に移動し、使用可能なデバイスを見つけます。  または  を押して必要なデバイスに移動し、 を押して選択します。

- 6  または  を押して【せつぞく】に移動し、 を押して選択します。

ディスプレイに【<デバイス> せつぞくちゅう】と表示されます。ペアリングを完成させるには、Bluetooth 対応デバイスでさらに手順が必要になることがあります。Bluetooth 対応デバイスの『ユーザー マニュアル』を参照してください。

成功すると、無線機のディスプレイに【<デバイス> せつぞくずみ】と表示されます。トーンが鳴り、接続先デバイスの隣に  が表示されます。ステータス バーに Bluetooth 接続済みアイコンが表示されます。

失敗すると、無線機のディスプレイに【せつぞくしっばい】と表示されます。



Bluetooth デバイスからの検索と接続 (検出可能モード)



検索動作中および接続動作中は、Bluetooth または無線機の電源を切らないでください。動作が取り消されてしまうことがあります。

- 1 Bluetooth の電源を入れます。

「[ブルートゥースのオン/オフの切り替え ページ 304](#)」を参照してください。

- 2  を押してメニューにアクセスします を押します。

- 3  または  を押して【Bluetooth】に移動し、 を押して選択します。

- 4  または  を押して【Find Me】に移動し、 を押して選択します。



ご使用の無線機が、プログラムされた期間に他の Bluetooth 対応デバイスで検出可能になります。これを検出可能モードと呼びます。



- 5 Bluetooth 対応デバイスの電源を入れ、無線機とペアリングします。



Bluetooth 対応デバイスの『ユーザー マニュアル』を参照してください。



Bluetooth デバイスからの切断

- 1 無線機で、 を押してメニューにアクセスしますを押します。

- 2  または  を押して [Bluetooth] に移動し、 を押して選択します。

- 3  または  を押して [デバイス] に移動し、 を押して選択します。

- 4  または  を押して必要なデバイスに移動し、 を押して選択します。

- 5  または  を押して [せつだん] に移動し、 を押して選択します。

ディスプレイに [デバイス] からせつだんちゆう] と表示されます。切断するには、Bluetooth 対応デバイスでさらに手順が必要になることがあります。

Bluetooth 対応デバイスの『ユーザー マニュアル』を参照してください。

無線機のディスプレイに、[デバイス] せつだんずみ] と表示されます。ポジティブ インジケータ トーンが鳴り、接続先デバイスの隣から ✓ が消えます。ステータス バーの Bluetooth 接続済みアイコンが消えます。

内部無線機スピーカと Bluetooth デバイスの間のオーディオ ルートの切り替え

内部無線機スピーカと外部 Bluetooth 対応アクセサリの間のオーディオ ルーティングを切り替えることができます。



プログラムされた [Bluetooth オーディオ切り替え] ボタンを押します。



- トーンが鳴り、ディスプレイに [おんせい] むせんき] と表示されます。



- トーンが鳴り、ディスプレイに『おんせい>ブルートゥース』と表示されます。



デバイスの詳細の表示

- 1  を押してメニューにアクセスします を押します。

- 2  または  を押して【Bluetooth】に移動し、 を押して選択します。

- 3  または  を押して【デバイス】に移動し、 を押して選択します。

- 4  または  を押して必要なデバイスに移動し、 を押して選択します。

- 5  または  を押して【しようさい】に移動し、 を押して選択します。

デバイス名の削除



Bluetooth 対応デバイスのリストから切断済みデバイスを削除できます。

- 1  を押してメニューにアクセスします を押します。



- 2  または  を押して【Bluetooth】に移動し、 を押して選択します。

- 3  または  を押して【デバイス】に移動し、 を押して選択します。



- 4  または  を押して必要なデバイスに移動し、 を押して選択します。

- 5  または  を押して【さくじょ】に移動し、
 を押して選択します。

ディスプレイに【デバイスさくじょずみ】と表示されます。

- 4  または  を押して【BT マイクゲイン】タイプおよび現在の値に移動します。



値を編集するには、 を押して選択します。



- 5  または  を押して値を大きくするか小さくして、 を押して選択します。

Bluetooth マイクゲイン

接続した Bluetooth 対応デバイスのマイク ゲインの値を制御できます。

- 1  を押してメニューにアクセスします を押します。

- 2  または  を押して【Bluetooth】に移動し、 を押して選択します。

- 3  または  を押して【BT マイクゲイン】に移動し、 を押して選択します。

屋内位置











注記:

屋内位置機能は、最新のソフトウェアおよびハードウェアを搭載したモデルにのみ適用されます。詳細については、ディーラーまたはシステム管理者にご確認ください。

屋内位置機能を使用して、無線機ユーザーの位置を追跡できます。屋内位置が有効になっていると、無線機は限定的に検出可能なモードになります。無線機を探して位置を特定するために、専用ビーコンが使用されます。

屋内位置のオンとオフ

屋内位置をオンまたはオフにするには、次の操作のいずれかを実行します。

- メニューからこの機能にアクセスします。
 - a.  を押してメニューにアクセスします を押します。
 - b.  または  を押して【Bluetooth】に移動し、 を押して選択します。
 - c.  または  を押して【屋内】に移動し、 を押して選択します。
 - d.  を押して【屋内】をオンにします。

ディスプレイに【屋内オン】と表示されます。ポジティブインジケータトーンが鳴ります。下記のいずれかの状態になります。

- 成功すると、[屋内位置利用可能] アイコンが【ホーム】画面に表示されます。

- 失敗すると、ディスプレイに【屋内オン失敗】と表示されます。ネガティブインジケータトーンが鳴ります。

- e.  を押して屋内をオフにします。

ディスプレイに【屋内オフ】と表示されます。ポジティブインジケータトーンが鳴ります。下記のいずれかの状態になります。

- 成功すると、[屋内位置利用可能] アイコンが【ホーム】画面から消えます。
- 失敗すると、ディスプレイに【屋内オフ失敗】と表示されます。ネガティブインジケータトーンが鳴ります。

- プログラムされたボタンを使用してこの機能にアクセスします。

- a. プログラムされた【屋内】ボタンを長押しして屋内をオンにします。

ディスプレイに【屋内オン】と表示されます。ポジティブインジケータトーンが鳴ります。下記のいずれかの状態になります。



- 成功すると、[屋内位置利用可能] アイコンが【ホーム】画面に表示されます。



- 失敗すると、ディスプレイに【屋内オン失敗】と表示されます。失敗すると、ネガティブインジケータトーンが鳴ります。
- b. プログラムされた **【屋内】** ボタンを押して屋内配置をオフにします。
- ディスプレイに【屋内オフ】と表示されます。ポジティブインジケータトーンが鳴ります。下記のいずれかの状態になります。
- 成功すると、【屋内位置利用可能】アイコンが【ホーム】画面から消えます。
 - 失敗すると、ディスプレイに【屋内オフ失敗】と表示されます。失敗すると、ネガティブインジケータトーンが鳴ります。



屋内位置ビーコン情報へのアクセス

下記の手順に従って、屋内位置ビーコン情報にアクセスします。

- 1  を押してメニューにアクセスします を押します。

- 2  または  を押して【Bluetooth】に移動し、 を押して選択します。

- 3  または  を押して【屋内】に移動し、 を押して選択します。

- 4  または  を押して【ビーコン】に移動して、 を押して選択します。

ディスプレイにビーコン情報が表示されます。

通知リスト

無線機には、未読のメッセージ、不在着信やページングなど、チャンネル上で"未読"のイベントをすべて収集する通知リストがあります。

通知リストにイベントが1件以上あると、ステータスバーに通知アイコンが表示されます。

リストでは、最大40の未読イベントを使用できます。リストがいっぱいになると、最も古いイベントが次のイベントで置き換えられます。

**注記:**

これらのイベントは、読まれた後、通知リストから削除されます。

通知リストへのアクセス

下記の手順に従って、通知リストにアクセスします。

- 1 を押してメニューにアクセスします を押します。

- 2 または を押して [お知らせ] に移動し、
 を押して選択します。

- 3 または を押して必要なイベントに移動し、
 を押して選択します。

ホーム画面に戻るには、 を長押しします。

Wi-Fi 操作

この機能で、Wi-Fi ネットワークをセットアップして接続できます。Wi-Fi は、無線機のファームウェア、コードプ

ラ、言語パックや音声ガイドなどのリソースの更新をサポートします。

**注記:**

この機能が適用されるモデルは、XiR M8668i/CM7668i のみです。

Wi-Fi® は Wi-Fi Alliance® の登録商標です。

お使いの無線機は、WEP/WPA/WPA2 パーソナル Wi-Fi および WPA/WPA2 エンタープライズ Wi-Fi のネットワークに対応しています。

WEP/WPA/WPA2 パーソナル Wi-Fi ネットワーク

事前共有キー (パスワード) ベースの認証を使用します。

事前共有キーは、メニューまたは CPS/RM を使用して入力できます。

WPA/WPA2 エンタープライズ Wi-Fi ネットワーク

証明書ベースの認証を使用します。

無線機を証明書使って事前設定しておく必要があります。

**注記:**

WPA/WPA2 エンタープライズ Wi-Fi ネットワークへの接続については、ディーラーまたはシステム管理者に確認してください。

プログラムされた [Wi-Fi オン/オフ] ボタンがディーラーまたはシステム管理者により割り当てられます。無線機がど

のようにプログラムされているかについては、ディーラーまたはシステム管理者に確認してください。

プログラムされた **[Wi-Fi オン/オフ]** ボタンの音声ガイドは、ユーザーの要件に応じて、**CPS** を使用してカスタマイズできます。詳細については、ディーラーまたはシステム管理者にご確認ください。







注記:



スーパーバイザ無線機を使用して、リモートで Wi-Fi をオンまたはオフにできます ([スーパーバイザ無線機を使用して Wi-Fi のオン/オフを切り替える](#) を参照)。詳細については、ディーラーまたはシステム管理者にご確認ください。

Wi-Fi のオン/オフの切り替え

下記の手順に従って、Wi-Fi のオンとオフを切り替えます。

- 1 プログラムされた **[Wi-Fi オン/オフ]** ボタンを押します。Wi-Fi のオンまたは Wi-Fi のオフの音声ガイドが聴こえます。
-
- 2 メニューを使用してこの機能にアクセスします。
 - a  を押してメニューにアクセスします を押します。

b  または  を押して **[Wi-Fi]** に移動し、 を押して選択します。

c  または  を押して **[Wi-Fi オン]** に移動し、 を押して選択します。

d  を押して、Wi-Fi をオン/オフにします。

Wi-Fi がオンの場合、ディスプレイで **[ゆうこう]** の隣に  が表示されます。

Wi-Fi がオフの場合は、**[ゆうこう]** の隣から  が消えます。



指定された無線機を使用してリモートで Wi-Fi をオンまたはオフにする (個別制御)



下記の手順に従って、個別制御 (1 対 1) でリモートで Wi-Fi のオン/オフを切り替えます。







注記:

特定の CPS 設定を持つ無線機のみがこの機能をサポートします。詳細については、ディーラーまたはシステム管理者にご確認ください。

- 以下のいずれか 1 つの手順を実行します。
 - プログラム可能ボタンを長押しします。キーパッドを使用して ID と  を押して選択しますを入力します。ステップ 3 に進みます。
 -  を押してメニューにアクセスします を押します。

-
-  または  を押して [れんらくさき] に移動し、 を押して選択します。

-
-  または  を押して、[WiFi せいぎょ] にアクセスし、 を押して選択します。

-
-  または  を押して [オン] または [オフ] を選択します。

-
-  を押して選択します。

成功すると、ディスプレイにポジティブ ミニ通知が表示されます。

失敗すると、ディスプレイにネガティブ ミニ通知が表示されます。

指定された無線機を使用してリモートで Wi-Fi をオンまたはオフにする (グループコントロール)



下記の手順に従って、グループコントロール (1 対多) でリモートで Wi-Fi のオン/オフを切り替えます。







注記:



特定の CPS 設定を持つ無線機のみがこの機能をサポートします。詳細については、ディーラーまたはシステム管理者にご確認ください。

-
-  を押してメニューにアクセスします を押します。

-
-  または  を押して [れんらくさき] に移動し、 を押して選択します。

-
-  または  を押して必要な無線機のエアリアスまたは ID を選択します。

4  または  を押して、【WiFi せいぎよ】にアクセスし、 を押して選択します。

5  または  を押して【オン】または【オフ】を選択します。

6  を押して選択します。

処理が正常に行われると、ディスプレイに【せいじょうにそうしん】と表示されます。

失敗すると、ディスプレイにネガティブミニ通知が表示されます。

ネットワーク アクセス ポイントへの接続

Wi-Fi をオンにすると、無線がネットワーク アクセス ポイントに接続します。









注記:



また、メニューからもネットワーク アクセス ポイントに接続できます。

WPA エンタープライズ Wi-Fi ネットワークのアクセス ポイントは、事前に設定されています。無線機がどのようにプログラムされているかについては、ディーラーまたはシステム管理者に確認してください。

1  を押してメニューにアクセスします を押します。

2  または  を押して【WiFi】に移動し、 を押して選択します。

3  または  を押して【ネットワーク】に移動して、 を押して選択します。

4  または  を押してネットワーク アクセス ポイントに移動し、 を押して選択します。

**注記:**

WPA エンタープライズ Wi-Fi で、ネットワーク アクセス ポイントが事前に設定されていない場合、【せつぞく】オプションは使用できません。

5 または を押して【せつぞく】に移動し、
 を押して選択します。

6 WPA パーソナル Wi-Fi の場合、パスワードを入力して を押します。

7 WPA エンタープライズ Wi-Fi の場合、パスワードは RM を使用して設定されます。

事前に設定されているパスワードが正しい場合、無線機は自動的に選択したネットワーク アクセス ポイントに接続します。

事前に設定したパスワードが正しくない場合、ディスプレイに【にんしょうエラー】と表示され、自動的に前のメニューへ戻ります。

接続に成功すると、無線に通知が表示され、ネットワーク アクセス ポイントがプロファイルリストに保存されます。

接続に失敗すると、無線のディスプレイに失敗通知画面が瞬時的に表示され、自動的に前のメニューへ戻ります。

Wi-Fi 接続ステータスの確認

下記の手順に従って、Wi-Fi 接続のステータスを確認します。

プログラムされた **[Wi-Fi ステータス照会]** ボタンを押し、音声ガイドで接続ステータスを確認します。Wi-Fi がオフ、Wi-Fi がオンで接続なし、または Wi-Fi がオンで接続ありの音声ガイドが流れます。

- Wi-Fi がオフになっていると、ディスプレイに【Wi-Fi オフ】と表示されます。
- 無線機がネットワークに接続されていると、ディスプレイに【Wi-Fi オン】、【接続済み】と表示されます。
- Wi-Fi がオンになっているが、無線機がネットワークに接続されていない場合、【Wi-Fi オン】、【切断済み】と表示されます。

Wi-Fi ステータス照会結果の音声ガイドは、ユーザーの要件に応じて、CPS を使用してカスタマイズできます。詳細については、ディーラーまたはシステム管理者にご確認ください。

**注記:**

プログラムされた **【Wi-Fi ステータス照会】** ボタンがディーラーまたはシステム管理者によって割り当てられます。無線機がどのようにプログラムされているかについては、ディーラーまたはシステム管理者に確認してください。

ネットワーク リストの更新

下記の手順に従って、ネットワーク リストを更新します。

- メニューからネットワーク リストを更新するには、次の操作を実行します。
 - a. を押してメニューにアクセスします を押します。
 - b. または を押して **【WiFi】** に移動し、 を押して選択します。
 - c. または を押して **【ネットワーク】** に移動して、 を押して選択します。
【ネットワーク】 メニューに移動すると、ネットワーク リストが自動的に更新されます。

- **【ネットワーク】** メニューをすでに移動している場合は、次の操作を実行してネットワーク リストを更新します。

または を押して **【こうしん】** に移動し、
 を押して選択します。

ネットワーク リストが更新され、最新のリストが表示されます。

ネットワークの追加



**注記:**



このタスクは、**WPA エンタープライズ Wi-Fi** ネットワークには適用されません。

使用可能なネットワークのリストに優先ネットワークがない場合は、次の操作を実行してネットワークを追加します。



- 1 を押してメニューにアクセスします を押します。

- 2 または を押して **【WiFi】** に移動し、
 を押して選択します。

3  または  を押して【ネットワーク】に移動して、 を押して選択します。

4  または  を押して【ネットワーク つかか】に移動し、 を押して選択します。

5 サービス セット 識別子 (SSID) を入力して、 を押します。



6  または  を押して【ひらく】に移動し、 を押して選択します。



7 パスワードを入力して、 を押します。
無線機にポジティブ ミニ通知が表示され、ネットワークが正常に保存されたことが示されます。



ネットワーク アクセス ポイントの詳細の表示



ネットワーク アクセス ポイントの詳細を表示できます。

1  を押してメニューにアクセスします を押します。

2  または  を押して【WiFi】に移動し、 を押して選択します。

3  または  を押して【ネットワーク】に移動して、 を押して選択します。

4  または  を押してネットワーク アクセス ポイントに移動し、 を押して選択します。

5  または  を押して【しようさい】に移動し、 を押して選択します。



注記:

通常の WPA パーソナル Wi-Fi と WPA エンタープライズ Wi-Fi では、表示されるネットワーク アクセス ポイントの詳細は異なります。

WPA パーソナル Wi-Fi

接続済みのネットワーク アクセス ポイントについては、サービス セット 識別子 (SSID)、セキュリティ モード、メディア アクセス 制御 (MAC) アドレス、およびインターネット プロトコル (IP) アドレスが無線機に表示されます。

接続されていないネットワーク アクセス ポイントについては、SSID およびセキュリティ モードが無線機に表示されます。

WPA エンタープライズ Wi-Fi

接続済みのネットワーク アクセス ポイントについては、SSID、セキュリティ モード、ID、拡張認証プロトコル (EAP) 方式、フェーズ 2 認証、証明書名、MAC アドレス、IP アドレス、ゲートウェイ、DNS1、および DNS2 が無線機に表示されます。

接続されていないネットワーク アクセス ポイントについては、SSID、セキュリティ モード、ID、EAP 方式、フェーズ 2 認証、および証明書名が無線機に表示されません。

ネットワーク アクセス ポイントの削除









注記:



このタスクは、エンタープライズ Wi-Fi ネットワークには適用されません。



プロファイル リストのネットワーク アクセス ポイントを削除するには、次の操作を実行します。



- 1  を押してメニューにアクセスします を押します。

- 2  または  を押して [WiFi] に移動し、
 を押して選択します。

- 3  または  を押して [ネットワーク] に移動して、
 を押して選択します。

- 4  または  を押して、選択したネットワーク
アクセス ポイントに移動し、
 を押して選択します。

- 5  または  を押して [さくじょ] に移動し、
 を押して選択します。

- 6  または  を押して [はい] に移動し、
を押して選択します。

無線機にポジティブ ミニ通知が表示され、選択したネットワーク アクセス ポイントが正常に削除されたことが示されます。

ユーティリティ



この章では、無線機で使用できるユーティリティ機能の操作について説明します。



無線機のトーンおよび警告のオンとオフの切り替え



必要に応じ、すべての無線機トーンやアラート (着信緊急警告トーンは除く) を有効にすることも無効にすることもできます。



プログラムされた **[全トーン/アラート]** ボタンを押しますトーンすべてのオンとオフを切り替えます。または以下の



手順に従って、無線機のメニューからこの機能にアクセスします。

- 1  を押してメニューにアクセスします  を押します。

- 2  または  を押して [せってい] に移動し、
 を押して選択します。

- 3  または  を押して [きのうせってい] に移動し、
 を押して選択します。

- 4  または  を押して [トーン/アラート] に移動し、
 を押して選択します。

- 5  または  を押して [ぜんトーン] に移動し、
 を押して選択します。





- 6  を押して、すべてのトーンおよびアラートを無効または有効にします。



ディスプレイで【ゆうこう】の隣に  が表示されます。



【ゆうこう】の隣から  が消えます。



トーン アラート ボリューム オフセット レベルの設定



必要に応じて、トーン アラート ボリューム オフセット レベルを調節できます。この機能は、音声ボリュームを基準としてトーンおよびアラートのボリュームを調節できます。

- 1  を押してメニューにアクセスします を押します。
- 2  または  を押して【せってい】に移動し、
 を押して選択します。



- 3  または  を押して【きのうせってい】に移動し、
 を押して選択します。

- 4  または  を押して【トーン/アラート】に移動し、
 を押して選択します。

- 5  または  を押して【音量 オフセット】に移動し、
 を押して選択します。

- 6  または  を押して必要なボリューム値にします。
対応する各ボリューム値のフィードバック トーンが鳴ります。



- 7 以下のいずれか 1 つの手順を実行します。



-  を押して、表示されている必要なボリューム値を維持します。
-  を押して、現在のボリューム オフセット設定を変更せずに終了します。



通話許可トーンのオンとオフの切り替え



必要に応じて、通話許可トーンの有効、無効を切り替えられます。

- 1  を押してメニューにアクセスします を押します。

- 2  または  を押して【せってい】に移動し、
 を押して選択します。

- 3  または  を押して【きのうせってい】に移動し、
 を押して選択します。

- 4  または  を押して【トーン/アラート】に移動し、
 を押して選択します。

- 5  または  を押して【きよかトーン】に移動し、
 を押して選択します。

- 6  を押して【きよかトーン】を有効または無効にします。



ディスプレイで【ゆうこう】の隣に  が表示されます。



【ゆうこう】の隣から  が消えます。



パワーアップ警告トーンのオンとオフの切り替え



必要に応じて、パワーアップ警告トーンのオンとオフを切り替えることができます。



- 1  を押してメニューにアクセスします を押します。

- 2  または  を押して【せってい】に移動し、
 を押して選択します。

- 3  または  を押して【きのうせってい】に移動し、
 を押して選択します。



4  または  を押して【トーンアラート】に移動し、 を押して選択します。

5  または  を押して【でんげんオン】に移動し、 を押して選択します。

6  を押して、パワー アップ警告トーンを有効または無効にします。
ディスプレイで【ゆうこう】の隣に  が表示されます。
【ゆうこう】の隣から  が消えます。

出力レベルの設定



各 **Connect Plus** ゾーンの無線機のパワー設定の高低をカスタマイズできます。



【】にすると、かなり離れた場所にある **Connect Plus** モードのタワーサイトと通信できます。【】にすると、近い場所にある **Connect Plus** モードのタワーサイトと通信できます。



プログラムされた **【出力レベル】** ボタンを押します 送信出力レベルを高と低の間で切り替えます。



以下の手順に従って、無線機のメニューからこの機能にアクセスします。

1  を押してメニューにアクセスします を押します。

2  または  を押して【せってい】に移動し、 を押して選択します。

3  または  を押して【きのうせってい】に移動し、 を押して選択します。

4  または  を押して【でんげん】に移動し、 を押して選択します。

5  または  を押して必要な設定に移動し、 を押して選択します。



✓ 選択した設定の隣に表示されます。  ボタンを長く押すと、いつでもホーム画面に戻ります。



画面は前のメニューに戻ります。



表示モードの変更

必要に応じて、無線機の表示モードをデイとナイトの間で切り替えられます。これにより、ディスプレイの色パレットが影響を受けます。



1  を押してメニューにアクセスします を押します。

2  または  を押して【せってい】に移動し、
 を押して選択します。

3  または  を押して【きのうせってい】に移動し、
 を押して選択します。

4  または  を押して【ひょうじ】に移動し、
 を押して選択します。

ディスプレイに【デイモード】と【ナイトモード】が表示されます。

5  または  を押して必要な設定に移動し、
 を押して有効にします。 ✓ 選択した設定の隣にが表示されます。

表示輝度の調整



必要に応じて、無線機の表示輝度を調整できます。









注記:



【あかるさじどう】が有効の場合、表示輝度は調整できません。



1  を押してメニューにアクセスします を押します。

- 2  または  を押して【せってい】に移動し、
 を押して選択します。

- 3  または  を押して【きのうせってい】に移動し、
 を押して選択します。

- 4  または  を押して【ひょうじ】に移動し、
 を押して選択します。



- 5  または  を押して【きど】に移動し、
 を押して選択します。
進行状況バーが表示されます。



- 6 表示輝度を下げるには  、上げるには  を押します。設定 1 ~ 8 から選択します。
 を押して入力を確定します。



導入画面のオンとオフの切り替え



必要に応じて、導入画面の有効、無効を切り替えられます。



- 1  を押してメニューにアクセスします を押します。

- 2  または  を押して【せってい】に移動し、
 を押して選択します。

- 3  または  を押して【きのうせってい】に移動し、
 を押して選択します。







- 4  または  を押して【ひょうじ】に移動し、
 を押して選択します。









- 5  または  を押して【しよきがめん】に移動し、
 を押して選択します。

- 6  を押して [しょきがめん] を有効または無効にします。
- ディスプレイで [ゆうこう] の隣に  が表示されます。
- [ゆうこう] の隣から  が消えます。
-

言語





無線機ディスプレイの表示言語を設定できます。

- 1  を押してメニューにアクセスします を押します。
-
- 2  または  を押して [せってい] に移動し、
 を押して選択します。
-
- 3  または  を押して [きのうせってい] に移動し、
 を押して選択します。
-

- 4  または  を押して [げんご] に移動し、
 を押して選択します。
-
- 5  または  を押して必要な言語に移動し、
 を押して有効にします。  選択した言語の隣に  が表示されます。
-

LED インジケータのオンとオフの切り替え

必要に応じて、LED インジケータを有効または無効にできます。

- 1  を押してメニューにアクセスします を押します。
-
- 2  または  を押して [せってい] に移動し、
 を押して選択します。
-

3 ▲ または ▼ を押して【きのうせってい】に移動し、 を押して選択します。

4 ▲ または ▼ を押して【LED ひょうじ】に移動し、 を押して選択します。

5  を押して【LED ひょうじ】を有効または無効にします。
ディスプレイで【ゆうこう】の隣に ✓ が表示されます。
【ゆうこう】の隣から ✓ が消えます。

ケーブル タイプの特定

無線機で使用するケーブルのタイプを選択することができます。

1  を押してメニューにアクセスします を押します。

2 ▲ または ▼ を押して【せってい】に移動し、 を押して選択します。

3 ▲ または ▼ を押して【きのうせってい】に移動し、 を押して選択します。

4 ▲ または ▼ を押して【ケーブル タイプ】に移動し、 を押して選択します。



5 現在のケーブル タイプは ✓ で示されます。



音声ガイド



この機能では、ユーザーが割り当てたばかりの現在のゾーンとチャンネル、またはプログラム可能ボタンが押されたことを音声で知らせることができます。この音声インジケータは、お客様の要件に応じてカスタマイズできます。ディ

スプレイに表示されているコンテンツの読み取りが困難な状況で役立ちます。





- 1  を押してメニューにアクセスします を押します。

- 2  または  を押して【せってい】に移動し、
 を押して選択します。

- 3  または  を押して【きのうせってい】に移動し、
 を押して選択します。

- 4  または  を押して【おんせいガイド】に移動し、
 を押して選択します を押して選択します。
または を使用して、選択したオプションを変更することもできます。



- 5 以下のいずれか 1 つの手順を実行します。



-  を押して【おんせいガイド】を有効にします。ディスプレイで【ゆうこう】の隣に  が表示されます。
-  を押して【おんせいガイド】を無効にします。【ゆうこう】の隣から  が消えます。



メニュータイマー



ホーム画面に自動的に切り替わるまでメニューが表示され続ける時間を設定します。



- 1  を押してメニューにアクセスします を押します。

- 2  または  を押して【せってい】に移動し、
 を押して選択します。

- 3  または  を押して【きのうせってい】に移動し、
 を押して選択します。

4  または  を押して【ひょうじ】に移動し、
 を押して選択します。

5  または  を押して【タイマー メニュー】
に移動し、 を押して選択します。

6  または  を押して必要な設定に移動し、
 を押して選択します。

ホーンとライトのオンとオフの切り替え



この機能は、無線機の背面アクセサリ コネクタを使用して、ディーラーがインストールする必要があります。



無線機では、着信通話をホーンとライトで知らせることができます。この機能を有効にすると、着信通話があるたびに車両のホーンが鳴り、ライトが点灯します。



1 以下のいずれか 1 つの手順を実行します。

- プログラムされた【ホーン/ライト】ボタンを押して、ホーンとライト機能のオンとオフを切り替えます。以下の手順をスキップします。

-  を押してメニューにアクセスします を押します。
-

2  または  を押して【せってい】に移動し、
 を押して選択します。

3  または  を押して【きのうせってい】に移動し、
 を押して選択します。

4  または  を押して【ホーン/ライト】に移動し、
 を押して選択します。

5  を押して【ホーン/ライト】を有効または無効にします。



ディスプレイで【ゆうこう】の隣に  が表示されます。



【ゆうこう】の隣から  が消えます。



デュアル ノブ操作優先度の設定



無線機には、二重目的の**音量/チャンネル ノブ**があります。二重目的のオプションを無効にすると、ノブは音量ノブとしてのみ機能するように設定されます。

- 1  を押してメニューにアクセスします。]

- 2  または  を押して【せってい】に移動し、
 を押して選択します。

- 3  または  を押して【きのうせってい】に移動し、
 を押して選択します。

- 4  または   を押して選択します を押して【デュアル ダイアル】に移動して。



- 5 ディスプレイに【おんりょうのみ】と【おんりょうCH】が表示されます。  または   を押して選択します を押して必要な設定に移動して、
✓ 選択した設定の隣に表示されます。



画面は前のメニューに戻ります。



デジタル Mic AGC (Mic AGC-D)

この機能を使用すると、デジタルシステム上で送信するときに、無線機のマイクゲインを自動的に制御できます。大きい音が出ないようにしたり小さい音をプリセット値まで増幅したりして、音声レベルを一定に保ちます。

- 1  を押してメニューにアクセスします を押します。

- 2  または  を押して【せってい】に移動し、
 を押して選択します。

- 3  または  を押して【きのうせってい】に移動し、
 を押して選択します。

- 4  または  を押して【Mic AGC-D】に移動し、
 を押して選択します。

5 以下のいずれか 1 つの手順を実行します。

-  を押して **[Mic AGC-D]** を有効にします。ディスプレイで「ゆうこう」の隣に  が表示されます。
-  を押して **[Mic AGC-D]** を無効にします。  が「ゆうこう」の隣から消えます。

インテリジェント オーディオ











あらゆる定常騒音源と非定常騒音源を含め、周辺環境の背景雑音が大きの場合、それに負けないように音量を自動的に調整することができます。この機能は受信側限定であり、送信音声は影響を受けません。

- 1  を押してメニューにアクセスします を押します。

無線 機コ ント ロー ル

手順

メ ニ ュー

- a  を押してメニューにアクセスします を押します。
- b  または  を押して「きのうせってい」に移動し、  を押して選択します。
- c  または  を押して「きのうせってい」に移動し、  を押して選択します。
- d  または  を押して「Intオーディオ」に移動し、  を押して選択します。

無線
機
コ
ント
ロー
ル

手順



注記:

または を使用して、選択したオプションを変更することもできます。

e 以下のいずれか 1 つの手順を実行します。

- を押して、インテリジェント オーディオを有効にします。ディスプレイで【ゆうこう】の隣に ✓ が表示されます。
- を押して、インテリジェント オーディオを無効にします。【ゆうこう】の隣から ✓ が消えます。

2 または を押して【せってい】に移動し、 を押して選択します。

3 または を押して【きのうせってい】に移動し、 を押して選択します。

4 または を押して【Int オーディオ】に移動し、 を押して選択します。

5 以下のいずれか 1 つの手順を実行します。



- を押して、インテリジェント オーディオを有効にします。ディスプレイで【ゆうこう】の隣に ✓ が表示されます。
- を押して、インテリジェント オーディオを無効にします。【ゆうこう】の隣から ✓ が消えます。



内蔵自動ボリューム コントロールを使用して同様のパフォーマンスを達成するための推奨 Bluetooth 対応オーディオ アクセサリについては、「認可されたアクセサリ リスト」を参照してください。



ハウリング抑制機能のオンとオフの切り替え

この機能により、受信コールでのハウリングを最小限に抑えることができます。





1  を押してメニューにアクセスします を押します。

2  または  を押して【せってい】に移動し、
 を押して選択します。

3  または  を押して【きのうせってい】に移動し、
 を押して選択します。

4  または  を押して【ハウリングよくせい】に移動し、
 を押して選択します。
または を使用して、選択したオプションを変更することもできます。

5 次のいずれかを実行します。

-  を押して、ハウリング抑制機能を有効にします。ディスプレイで【ゆうこう】の隣に  が表示されます。
-  を押して、ハウリング抑制機能を無効にします。【ゆうこう】の隣から  が消えます。

GNSS のオンとオフの切り替え

グローバルナビゲーション衛星システム (GNSS) は、無線機の正確な位置を測定する衛星ナビゲーションシステムです。GNSS には、グローバルポジショニングシステム (GPS)、グローバルナビゲーション衛星システム (GLONASS)、北斗衛星導航系統 (BDS) が含まれます。









注記:



選択した無線機のモデルが GPS、GLONASS、および BDS を備えていることがあります。GNSS で使用する衛星群は CPS を使用して構成されています。無線機がどのようにプログラムされているかについては、ディーラーまたはシステム管理者に確認してください。



- 1 以下のいずれか 1 つの手順を実行します。

- プログラムされた **[GNSS]** ボタンを押して、この機能のオンとオフを切り替えます。以下の手順をスキップします。
-  を押してメニューにアクセスします。

2  または  を押して **[せってい]** に移動します。  を押して選択します。

3  または  を押して **[きのうせってい]** に移動します。  を押して選択します。

4  または  を押して **[GNSS]** に移動します。  を押して選択します。



5  を押して **GNSS** の有効と無効を切り替えます。有効にすると、 が **[ゆうこう]** の隣に表示されます。無効な場合、 が **[ゆうこう]** の隣で非表示になります。

GNSS 情報の取得については、[GNSS 情報の確認 ページ 346](#) を参照してください。

一般無線機情報へのアクセス

無線機に関する情報には、以下の情報があります。



- バッテリ
- 傾きの程度 (加速度計)
- 無線機モデルの番号索引
- オプション ボード無線 (OTA) コードプラグ CRC
- サイト番号
- サイト情報
- 無線エイリアスと ID
- ファームウェアとコードプラグの各バージョン
- **GNSS** に関する情報



 を押すと、いつでも前の画面に戻ります。 を長く押すとホーム画面に戻ります。無線機は、無操作タイマーの終了後に、現在の画面を終了します。



無線機モデル番号インデックスの確認

このインデックス番号は、無線機のモデル固有のハードウェアを識別します。無線機のシステム管理者は、お使いの無線機用の新しいオプション ボード コードプラグを用意するときに、この番号を尋ねることがあります。

- 1  を押してメニューにアクセスします を押します。

- 2  または  を押して [せってい] に移動し、
 を押して選択します。



- 3  または  を押して [きき じょうほう] に移動し、
 を押して選択します。



- 4  または  を押して [モデル インデックス] に移動し、
 を押して選択します。
ディスプレイにモデル番号インデックスが表示されます。



オプション ボード OTA コードプラグ ファイルの CRC の確認

オプション ボード OTA コードプラグ ファイルの CRC (Cyclic Redundancy Check) を表示するよう無線機のシステム管理者から依頼された場合は、次の手順に従います。このメニュー オプションは、オプション ボードで、最新のコードプラグアップデート OTA を受信したときにのみ表示されます。

- 1  を押してメニューにアクセスします を押します。

- 2  または  を押して [せってい] に移動し、
 を押して選択します。

- 3  または  を押して [きき じょうほう] に移動し、
 を押して選択します。

- 4  または  を押して [OEG OTA CPerc] に移動し、 を押して選択します。

ディスプレイに、いくつかの文字と数字が表示されます。この情報を表示されたとおり正確に、無線機のシステム管理者に伝えてください。





サイト ID (サイト番号) の表示









注記:

現在サイトに登録されていない場合は、ディスプレイに【みとよろく】と表示されます。

無線機では、**Connect Plus** サイトに登録するときに、サイト ID を短く表示します。無線機では、通常は、登録に続いてサイト番号を表示しません。登録されているサイト番号を表示するには、次の手順に従います。

- 1  を押してメニューにアクセスします を押します。
- 2  または  を押して [せってい] に移動し、 を押して選択します。

- 3  または  を押して [きき じょうほう] に移動し、 を押して選択します。

- 4  または  を押して [サイトばんごう] に移動し、 を押して選択します。

ディスプレイに [ネットワーク ID] および [サイトばんごう] が表示されます。

サイト情報の確認



注記:



現在サイトに登録されていない場合は、ディスプレイに【みとよろく】と表示されます。



「サイト情報」機能には、サービス技術者に役立つ情報があります。次の情報で構成されています。



- 現在の制御チャネルリピータのリピータ番号。
- **RSSI:** 制御チャネルリピータから測定された最終信号強度値。
- 制御チャネルリピータにより送信される周辺リスト (コンマで区切られた **5** つの数字)。

この機能を使用するように依頼されたら、画面に表示された情報を正確に報告してください。

- 1  を押してメニューにアクセスします を押します。



- 2  または  を押して【せってい】に移動し、
 を押して選択します。



- 3  または  を押して【きき じょうほう】に移動し、
 を押して選択します。



- 4  または  を押して【サイトじょうほう】に移動し、
 を押して選択します。
ディスプレイに「サイト情報」が表示されます。

次に説明する手順に従って、この機能に無線機の画面からアクセスします。

- 1  を押してメニューにアクセスします を押します。

- 2  または  を押して【せってい】に移動し、
 を押して選択します。

- 3  または  を押して【きき じょうほう】に移動し、
 を押して選択します。

- 4  または  を押して【ID】に移動し、
 を押して選択します。
ディスプレイに無線機 ID が表示されます。



無線機 ID の確認



この機能により、無線機の ID が表示されます。



ファームウェアバージョンとコードプラグバージョンのチェック

無線機のファームウェアバージョンが表示されます。

1  を押してメニューにアクセスします を押します。

2  または  を押して【せってい】に移動し、
 を押して選択します。

3  または  を押して【きき じょうほう】に移動し、
 を押して選択します。

4  または  を押して【バージョン】に移動し、
 を押して選択します。

ディスプレイに次の情報のリストが表示されます。

- (無線機の) ファームウェアのバージョン
- (無線機の) コードプラグのバージョン
- オプション ボード ファームウェア バージョン

- オプション ボード周波数バージョン
- オプション ボード ハードウェア バージョン
- オプション ボード コードプラグ バージョン

更新の確認

Connect Plus には、特定のファイル (オプション ボード コードプラグ、ネットワーク周波数ファイル、オプション ボード ファームウェア ファイル) を無線 (OTA) で更新する機能が用意されています。



注記:

無線機でこの機能が有効にされているかどうかについては、ディーラーまたはネットワーク管理者に確認してください。

すべてのディスプレイ **Connect Plus** 無線機には、メニューオプションを使用して現在のオプション ボード OTA コードプラグ **CRC**、周波数ファイルバージョン、オプション ボード ファームウェア ファイルバージョンを表示する機能があります。さらに、無線ファイル転送を有効にしたディスプレイ無線機では、“保留中ファイル”のバージョンを表示できます。“保留中ファイル”は、システム メッセージングを介して **Connect Plus** 無線機で認識している一方で、一部のファイルバケットをまだ無線機で収集していない、周波数ファイルまたはオプション ボード ファームウェア

ファイルです。ディスプレイ **Connect Plus** 無線機に保留中のファイルがある場合、メニューには、次の操作のためのオプションが示されます。

- 保留中ファイルのバージョン番号を参照。
- これまでに収集されたパケットの割合を参照。
- **Connect Plus** 無線機にファイルパケットの収集の再開を要求。

無線機で **Connect Plus** OTA ファイル転送が有効にされている場合は、最初に無線機ユーザーに通知しないで、無線機が自動的にファイル転送に参加する期間が取られることがあります。無線機がファイルパケットを収集している間、LED は高速で赤色に点滅し、ホーム画面のステータスバーに大量データアイコンが表示されます。



注記:

Connect Plus 無線機では、ファイルパケットの収集とコールの受信を同時に行うことができません。ファイル転送をキャンセルするには、**PTT** ボタンを押して放します。これにより、無線機は選択した連絡先名での通話を要求し、このプロセスが後で再開されるまでこの無線機のファイル転送もキャンセルされます。

ファイル転送プロセスを再開させる方法は複数あります。最初の例は、すべての **OTA** ファイルタイプに適用されず。もう 1 つの例は、ネットワーク周波数ファイルとオプ

ション ボード ファームウェア ファイルのみに適用されません。

- 無線機システム管理者が **OTA** ファイル転送を再開します。
- オプション ボードの事前定義されたタイマーの期限が切れます。この結果、オプション ボードでは、パケット収集プロセスが自動的に再開されます。
- タイマーの期限がまだ切れていなくても、無線機ユーザーがメニュー オプションから要求すれば、ファイル転送が再開されます。

全ファイルパケットのダウンロードを完了すると、**Connect Plus** 無線機では、新しく取得したファイルにアップグレードする必要があります。ネットワーク周波数ファイルの場合、これは自動プロセスであり、無線機のリセットを必要としません。オプション ボード コードプラグファイルの場合、これは、オプション ボードで新しいコードプラグ情報をロードし、ネットワークサイトを取得し直すため、サービスを短時間中断することになる自動プロセスです。無線機で新しいオプション ボード ファームウェア ファイルへのアップグレードを行うまでの時間は、無線機がディーラーまたはシステム管理者によってどのように構成されているかに応じて異なります。無線機では、すべてのファイルパケットを収集すると即座にアップグレードするか、ユーザーが無線機を次回オンにするまで待ちます。

**注記:**

無線機がどのようにプログラムされているかについては、ディーラーまたはシステム管理者に確認してください。

新しいオプション ボード ファームウェア ファイルへのアップグレード プロセスは数秒かかり、**Connect Plus** オプション ボードによる無線機のリセットを必要とします。アップグレードが開始されると、無線機ユーザーはプロセスが完了するまでコールを発信も受信もできません。このプロセス中に、無線機の電源を切らないよう求めるプロンプトが表示されます。

ファームウェア ファイル



このセクションには、無線ファームウェアの情報を記載しています。



ファームウェアの更新



**注記:**



オプション ボード ファームウェア ファイルが最新状態でない場合 (および無線機が最新のオプション ボード ファームウェア バージョンを部分的に収集していた場合)、無線機には追加オプション (【バージョン】、【% じゅしんずみ】、【ダウンロード】) が含まれたリストが表示されます。

- 1  を押してメニューにアクセスします を押しします。

- 2  または  を押して【せってい】に移動し、
 を押して選択します。

- 3  または  を押して【きき じょうほう】に移動し、
 を押して選択します。



- 4  または  を押して【こうしん】に移動し、
 を押して選択します。



- 5  または  を押して【ファームウェア】に移動し  を押して選択します。



ディスプレイに【ファームウェアはさいしんです】と表示されます。



保留中ファームウェア - バージョン



- 1  を押してメニューにアクセスします を押し
ます。
-

- 2  または  を押して【せってい】に移動し、
 を押して選択します。
-

- 3  または  を押して【きき じょうほう】に
移動し、  を押して選択します。
-

- 4  または  を押して【こうしん】に移動し、
 を押して選択します。
-

- 5  または  を押して【ファームウェア】に移動し  を押して選択します。
-



- 6  または  を押して【バージョン】に移動し、
 を押して選択します。



保留中のオプション ボード ファームウェア ファイルがある場合、ディスプレイには、保留中のオプション ボード ファームウェア ファイルのバージョン番号が表示されます。



オプション ボード ファームウェア ファイルがない場合は、ディスプレイに【ファームウェアはさいしんです】と表示されます。



保留中のファームウェア - 受信割合



- 1  を押してメニューにアクセスします を押し
ます。
-

- 2  または  を押して【せってい】に移動し、
 を押して選択します。

- 3  または  を押して【きき じょうほう】に移動し、
 を押して選択します。

- 4  または  を押して【こうしん】に移動し、
 を押して選択します。

- 5  または  を押して【ファームウェア】に移動し
 を押して選択します。

- 6  または  を押して【% じゅしんずみ】に移動し、
 を押して選択します。
これまでに収集したファームウェア ファイルパッケージの割合が画面に表示されます。



**注記:**



100% になったら無線機の電源をいったん切ってから再投入して、ファームウェアのアップグレードを開始する必要があります。



保留中ファームウェア - ダウンロード



事前に、**Connect Plus** 無線機でファイルを部分的に転送して OTA オプション ボード ファームウェア ファイル転送から離れているとき、内部タイマーの期限が切れるとユニットはファイル転送に自動的に復帰します (まだ進行中の場合)。この内部タイマーの期限が切れる前にユニットを進行中のオプション ボード ファームウェア ファイル転送に復帰させるには、下記の説明に従って【ダウンロード】オプションを使用します。



- 1  を押してメニューにアクセスします を押し
ます。

- 2  または  を押して【せってい】に移動し、
 を押して選択します。

3  または  を押して【きき じょうほう】に移動し、 を押して選択します。



4  または  を押して【こうしん】に移動し、 を押して選択します。

5  または  を押して【ファームウェア】に移動し  を押して選択します。

6  または  を押して【ダウンロード】に移動し、 を押して選択します。
ディスプレイに、次のメッセージが表示されます。

ダウンロード使用可能	[Start Download]〈ダウンロードかいし〉
ダウンロード使用不可	[Download not available]〈ダウンロードしようふか〉

7 以下のいずれか 1 つの手順を実行します。

- 【はい】を選択して  を押すと、ダウンロードが開始されます。
- 【いいえ】を選択して  を押すと、前のメニューに戻ります。

周波数ファイル

このセクションには、無線機の周波数ファイルに関する情報を記載しています。



周波数ファイルの更新









注記:

周波数ファイルが最新ではない場合 (および無線機が最新の周波数ファイルバージョンを部分的に収集していた場合)、無線機には追加オプション (【バージョン】、【% じゅしんずみ】、【ダウンロード】) が含まれたリストが表示されます。

- 1  を押してメニューにアクセスします を押します。



2  または  を押して【せってい】に移動し、
 を押して選択します。



3  または  を押して【きき じょうほう】に移動し、
 を押して選択します。



4  または  を押して【しゅうはすう】に移動し、
 を押して選択します。
ディスプレイに【Freq.ファイルはさいしんです】と表示されます。



周波数ファイル保留中 - バージョン



1  を押してメニューにアクセスします を押します。

2  または  を押して【せってい】に移動し、
 を押して選択します。

3  または  を押して【きき じょうほう】に移動し、
 を押して選択します。

4  または  を押して【こうしん】に移動し、
 を押して選択します。



5  または  を押して【しゅうはすう】に移動し、
 を押して選択します。



6  または  を押して【バージョン】に移動し、
 を押して選択します。



保留中の周波数ファイルがある場合、ディスプレイには、保留中の周波数ファイルのバージョン番号が表示されます。



周波数ファイル保留中 - 受信割合

1  を押してメニューにアクセスします を押します。

2  または  を押して【せってい】に移動し、
 を押して選択します。

3  または  を押して【きき じょうほう】に移動し、
 を押して選択します。

4  または  を押して【こうしん】に移動し、
 を押して選択します。

5  または  を押して【% じゅしんずみ】に移動し、
 を押して選択します。



これまでに収集した周波数ファイルパケットの割合が画面に表示されます。



周波数ファイル保留中 - ダウンロード



事前に、Connect Plus 無線機でファイルを部分的に転送して OTA ネットワーク周波数ファイル転送から離れているとき、内部タイマーの期限が切れるとユニットはファイル転送に自動的に復帰します (まだ進行中の場合)。この内部タイマーの期限が切れる前にユニットを進行中のネットワ



ーク周波数ファイル転送に復帰させるには、下記の説明に従って【ダウンロード】オプションを使用します。



1  を押してメニューにアクセスします を押します。

2  または  を押して【せってい】に移動し、
 を押して選択します。

3  または  を押して【きき じょうほう】に移動し、
 を押して選択します。

4  または  を押して【こうしん】に移動し、
 を押して選択します。

5  または  を押して【しゅうはすう】に移動し、
 を押して選択します。

- 6  または  を押して【ダウンロード】に移動し、 を押して選択します。

ダウンロードは現在使用不可	[Download not available] (ダウンロードしようふか)
ダウンロードは現在使用可能	[Start Download] (ダウンロードかいし)

- 7 以下のいずれか 1 つの手順を実行します。
- 【はい】を選択して押すと、ダウンロードが開始されます。
 - 【いいえ】を選択して押すと、前のメニューに戻ります。



GNSS 情報の確認



無線機の GNSS 情報を表示します。



- 緯度
- 経度



- 高度
- 方向
- 速度
- HDOP
- 衛星
- バージョン

- 1  を押してメニューにアクセスします を押します。

- 2  または  を押して【せってい】に移動し、 を押して選択します。

- 3  または  を押して【きき じょうほう】に移動し、 を押して選択します。







- 4  または  を押して【GNSS じょうほう】に移動し、 を押して選択します。

- 5  または  を押して必要な項目に移動し、
 を押して選択します。
要求した GNSS 情報がディスプレイに表示されます。



GNSS の詳細については、[GNSS のオンとオフの切り替えページ 333](#) を参照してください。

エンタープライズ Wi-Fi 証明書の詳細の表示

選択したエンタープライズ Wi-Fi 証明書の詳細を表示することができます。

- 1  を押してメニューにアクセスします。
-
- 2  または  を押して【せってい】に移動します。
 を押して選択します。
-
- 3  または  を押して【証明書メニュー】に移動します。
 を押して選択します。

✓ 準備が完了した証明書の横に表示されます。

- 4  または  を押して必要な証明書に移動します。
 を押して選択します。

無線機に、証明書の完全な詳細が表示されます。



注記:

準備が完了していない証明書については、ステータスのみ表示されます。

他のシステム

このシステムで無線機ユーザーが利用可能な機能については、この章で取り扱います。

プッシュアウトーク ボタン

プッシュアウトーク ボタン (PTT) ボタンには基本的に 2 つの目的があります。

- 通話中に **PTT** ボタンを使用して、通話に加わっている他の無線機に送信できます。**PTT** ボタンを押すと、マイクが有効になります。
- 通話中でないときは、新規通話を発信するために [**PTT**] ボタンを使用します。

話すには、**PTT** ボタンを押して応答します。相手の声を聞くには、**PTT** ボタンを放します。

通話許可トーンまたは **PTT** サイドトーン  が有効となっている場合は、短い警告トーンが終了してから話します。

 お使いの無線機でチャンネルフリー通知機能が有効になっている (ディーラーによってプログラムされている) 場合、ターゲットの無線機 (通話を受けている無線機) で [**PTT**] ボタンが放された瞬間に、短いアラート トーンが鳴ります。これは、そのチャンネルが空いて、応答できるようになったことを示します。

 通話が中断されると、継続した通話禁止音が聞こえます。通話禁止音が継続的に聞こえた場合は、**PTT** ボタンを放します。

プログラム可能ボタン

ディーラーは、プログラム可能ボタンに対して、ボタンを押す長さごとに、無線機能へのショートカットをプログラムできます。

短押し

押してすぐに離します。

長押し

プログラムされた時間の間、押し続けます。



注記:

【きんきゅう】 ボタンを押す長さをプログラミングする方法については、「[緊急操作 ページ 430](#)」を参照してください。

指定可能な無線機機能

無線機の以下の機能をプログラム可能なボタンに割り当てることができます。

音声アンビエンス

無線機が動作する環境をユーザーが選択できます。

音声プロフィール

優先される音声プロフィールをユーザーが選択できません。

Bluetooth® オーディオ切り替え

内部無線機スピーカと外部 Bluetooth 対応アクセサリの間のオーディオルーティングを切り替えます。

Bluetooth 接続

Bluetooth の検出と接続の動作を開始します。

Bluetooth 切断

無線機と Bluetooth 対応デバイス間のすべての既存の Bluetooth 接続を終了します。

Bluetooth 検出可能

無線機を Bluetooth 検出可能モードに切り替えることができます。

ページング

連絡先リストに直接アクセスして、ページングの送信先となる連絡先を選択できるようにします。

通話転送

通話転送機能のオンとオフを切り替えます。

通話履歴

通話履歴のリストを選択します。

チャンネル アナウンスメント

現在のチャンネルのゾーンとチャンネルアナウンス音声メッセージを示します。

連絡先

連絡先リストに直接アクセスできます。

緊急

プログラムに応じて、緊急通話を始動またはキャンセルします。

外部パブリック アドレス (PA)

接続した PA ラウドスピーカ増幅器と無線機の内部 PA システムの間のオーディオルーティングを切り替えます。

屋内位置

屋内位置のオンとオフを切り替えます。

Int オーディオ

インテリジェント オーディオのオンとオフを切り替えます。

ダイヤル

無線機の ID を入力して個別コールを開始します。

手動サイト ローミング ⁷

手動サイト検索を開始します。

⁷ Capacity Plus では利用できません。

Mic AGC

内部マイクの自動ゲイン制御 (AGC) のオンとオフを切り替えます。

モニタ

選択されたチャンネルのアクティビティをモニタします。

通知

通知リストに直接アクセスできます。

迷惑チャンネル削除⁷

選択されたチャンネルを除く不要なチャンネルをスキャンリストから一時的に削除します。選択されたチャンネルとは、スキャンの開始元として選択されたゾーンまたはチャンネルの組み合わせを指します。

ワンタッチ アクセス⁶

事前に定義した個別コール、電話通話、グループコール、ページング、クイックテキストメッセージ、またはホーム復帰を直接開始します。

オプション ボード機能

オプション ボード対応チャンネルで、オプション ボード機能のオンとオフを切り替えます。

連続モニタ⁷

機能が無効になるまで、選択されたチャンネルですべての無線機トラフィックをモニタします。

電話⁶

電話連絡先リストに直接アクセスできます。

秘話モード⁶

秘話モードのオンとオフを切り替えます。

パブリック アドレス (PA)

無線機の内部 PA システムのオンとオフを切り替えます。

無線エイリアスと ID

無線エイリアスと ID を提供します。

無線機チェック⁶

システム内の無線機がアクティブであるかどうかを判別します。

無線停止⁶

相手の無線機を遠隔で無効にできます。

停止解除⁶

ターゲットの無線機を遠隔で有効にできます。

リモート モニタ

インジケータを表示せずにターゲットの無線機のマイクをオンにします。

リピータ/ダイレクト⁷

リピータの使用と、別の無線機との直接的な通信とを切り替えます。

ホームチャンネルのリセット

新規ホームチャンネルを設定します。

ホームチャンネルリマインダのミュート

ホームチャンネルリマインダをミュートします。

スキャン⁸

スキャンのオンとオフを切り替えます。

サイト情報

Capacity Plus-マルチサイトの現在のサイト名と ID を表示します。

音声ガイドが有効になっているときに、現在のサイトの音声ガイドメッセージを再生します。

サイトロック⁷

オンに切り替えた場合、無線機は現在のサイトのみを検索します。オフに切り替えた場合、無線機は現在のサイトに加え、他のサイトも検索します。

テレメトリコントロール⁹

ローカルまたはリモート無線機で、出力ピンをコントロールします。

テキストメッセージ⁹

テキストメッセージメニューを選択します。

強制停止⁹

現在進行中の割り込み可能な通話を停止し、チャンネルを解放します。

トリル拡張

トリル拡張のオンとオフを切り替えます。

音声ガイド オン/オフ

音声ガイドのオンとオフを切り替えます。

音声起動送信 (VOX)

VOX のオンとオフを切り替えます。

WiFi

Wi-Fi のオンとオフを切り替えます。

ゾーンせんたく

ゾーンのリストからの選択を可能にします。

指定可能な設定またはユーティリティ機能

無線機の以下の設定またはユーティリティ機能をプログラム可能なボタンに割り当てることができます。

トーン/アラート

全トーンとアラートのオンとオフを切り替えます。

⁸ Capacity Plus-シングルサイトでは利用できません。

バックライト

ディスプレイ バックライトのオンとオフを切り替えます。

チャンネル アップ/ダウン

プログラムに従い、チャンネルを次のチャンネルまたは前のチャンネルに切り替えます。

表示モード

デイ/ナイト表示モードのオンとオフを切り替えます。



出力レベル

送信出力レベルの高低を切り替えます。



プログラムされた機能へのアクセス

下記の手順に従って、無線機でプログラムされた機能にアクセスします。

- 1 以下のいずれか 1 つの手順を実行します。
 - プログラムされたボタンを押します。 **ステップ 3**に進みます。
 -  を押してメニューにアクセスします。
-

- 2  または  を押してメニュー機能に移動したら、 を押して機能を選択するか、サブメニューに移動します。
-

- 3 以下のいずれか 1 つの手順を実行します。

-  を押して前の画面に戻ります。
 - ホーム画面に戻るには、 を長押しします。一定の期間操作しないと、無線機は自動的にメニューを終了し、ホーム画面に戻ります。
メニュー ナビゲーション ボタンはキーパッド付きマイクにもあります。「[キーパッドマイク ボタン ページ 36](#)」を参照してください。
-

ステータス インジケータ

この章では、無線機で使用するステータス インジケータおよびオーディオ トーンについて説明します。





アイコン

無線機の液晶ディスプレイ (LCD) には、無線機の状態、テキスト エントリ、メニュー エントリが表示されます。

表 9: ディスプレイ アイコン

次のアイコンは、無線機ディスプレイ上部のステータス バーに表示されます。アイコンは外観や使用法の順に左詰めで配列され、チャンネル固有です。

	<p>BeiDou のみ利用可能 </p> <p>BeiDou のみの機能が有効になっています。測位を利用できる場合、アイコンは表示されたままになります。</p>
	<p>Bluetooth 接続</p> <p>Bluetooth 機能が有効です。リモートの Bluetooth デバイスが接続されています。</p>

	<p>Bluetooth 未接続</p> <p>Bluetooth の機能は有効ですが、接続されているリモートの Bluetooth デバイスはありません。</p>
	<p>通話履歴</p> <p>無線機の通話履歴。</p>
	<p>連絡先</p> <p>無線機の連絡先が使用可能です。</p>
	<p>緊急</p> <p>無線機が緊急モードです。</p>
	<p>フレックス RX リスト</p> <p>フレックス RX リストが有効です。</p>
	<p>GNSS 有効 </p> <p>GNSS 機能が有効です。測位を利用できる場合、アイコンは表示されたままになります。</p>

⁹ XiR M8660i/XiR M8668i/CM7668i にのみ適用されます。

	GNSS 利用不可  GNSS 機能は有効ですが、衛星からデータを受信していません。
	大量データ 大量データを受信中で、チャンネルがビジーです。
	屋内位置利用可能 ¹⁰ 屋内位置ステータスがオンで利用可能です。
	屋内位置利用不可 ¹⁰ Bluetooth が無効か、ビーコン スキャンが Bluetooth により一時停止しているため、屋内位置ステータスがオンですが利用できません。
	メッセージ 着信メッセージ。
	モニタ 選択されたチャンネルをモニタ中です。

	ミュートモード ミュートモードが有効になると、スピーカがミュートされます。
	通知 通知リストに、1つ以上の不在イベントがあります。
	オプションボード オプションボードが有効です。(オプションボード対応モデルのみ)。
	オプションボード非動作 オプションボードが無効です。
	無線 (Over-the-Air) プログラミング遅延タイマ 無線機の自動再起動までの残り時間を示します。
	受信信号強度インジケータ (RSSI) 表示されるバーの数は、無線機の信号強度を表します。バーが4本のときが最大強度です。このアイコンは受信時のみに表示されます。

¹⁰ 最新のソフトウェアおよびハードウェアを搭載したモデルにのみ適用されます。

	応答禁止 応答禁止が有効化されます。
	着信音のみ 呼出音モードが有効です。
	スキャン¹¹ スキャン機能が有効になっています。
	スキャン - 優先度 1¹¹ 無線機は、優先度 1 に指定されたチャネル/グループのアクティビティを検出します。
	スキャン - 優先度 2¹¹ 無線機は、優先度 2 に指定されたチャネル/グループのアクティビティを検出します。
	セキュア 秘話モード機能が有効です。

	サインイン 無線機はリモート サーバーにサインインします。
	サインアウト 無線機はリモート サーバーからサインアウトします。
	サイレント モード サイレント呼出音モードが有効です。
	サイト ローミング¹² サイト ローミング機能が有効です。
	¹¹ダイレクト モード リピータがない場合、無線機どうしで直接通信します。
	トーン無効 トーンがオフです。
	非セキュア 秘話モード機能が無効です。

¹¹ Capacity Plus では利用不可です。

¹² Capacity Plus-シングルサイトでは利用できません。

	投票スキャン 投票スキャン機能が有効です。
	Wi-Fi 優良¹³ Wi-Fi 信号が優良です。
	Wi-Fi 良好¹³ Wi-Fi 信号が良好です。
	Wi-Fi 標準¹³ Wi-Fi 信号が平均的です。
	Wi-Fi 不良¹³ Wi-Fi 信号が不良です。
	Wi-Fi 利用不能¹³ Wi-Fi 信号を利用できません。

表 10: 高度なメニュー アイコン

以下のアイコンは、2つのオプションのいずれかを選択できるメニュー項目の隣に表示されるか、2つのオプションがあるサブメニューがあることを示すために表示されます。

¹³ XiR M8668i/CM7668i にのみ適用されます。





	チェックボックス (チェックされている) オプションが選択されていることを示します。
	チェックボックス (空) オプションが選択されていないことを示します。
	黒く塗りつぶされたボックス そのメニュー項目のサブメニューで、オプションが選択されていることを示します。

表 11: Bluetooth デバイス アイコン

以下のアイコンも、デバイス タイプを示すために使用できる Bluetooth 対応デバイス リストで項目の隣に表示されません。

	Bluetooth オーディオ デバイス Bluetooth 対応オーディオ デバイス (ヘッドセットなど)。
---	---







	Bluetooth データ デバイス Bluetooth 対応データ デバイス (スキャナなど)。
	Bluetooth PTT デバイス Bluetooth 対応 PTT デバイス (PTT のみデバイス (POD) など)。

表 12: 通話アイコン

以下は、通話中にディスプレイに表示されるアイコンです。これらのアイコンは、[れんらく さき] リストにも表示され、エイリアスや ID タイプを示します。

	Bluetooth PC コール Bluetooth PC コール中であることを示します。 [れんらくさき] リストでは、Bluetooth PC コール エイリアス (名前) または ID (番号) を示します。
	[ディスパッチ コール] 連絡先タイプのディスパッチ コールは、サードパーティのテキスト メッセージ サーバーを介して、ディスパッ

チャ PC にテキスト メッセージを送信するために使用されます。	
	グループ コール一斉コール グループ コール中または一斉コール中であることを示します。 [れんらく さき] リストでは、グループのエイリアス (名前) または ID (番号) を示します。
	個別コール 個別コール中であることを示します。 [れんらく さき] リストでは、無線機のエイリアス (名前) または ID (番号) を示します。
	グループ コール一斉コールとしての通話 グループ コールまたは一斉コールとして通話中であることを示します。 [れんらく さき] リストでは、グループのエイリアス (名前) または ID (番号) を示します。

**個別コールとしての通話**

個別コールとして通話中であることを示します。

[れんらくさき] リストでは、電話のエイリアス (名前) または ID (番号) を示します。

表 13: JOB チケットアイコン

次のアイコンは、JOB チケット フォルダ内で、ディスプレイに一時的に表示されます。

**すべてのジョブ**

リストされているすべてのジョブを示します。

**新しいジョブ**

新しいジョブを示します。

**処理中**

ジョブの送信中です。これが表示された後で、JOB チケットの送信失敗または送信完了が示されます。

**送信失敗**

ジョブを送信できませんでした。

**送信完了**

ジョブが正常に送信されました。

**優先度 1**

ジョブの優先度が 1 であることを示します。

**優先度 2**

ジョブの優先度が 2 であることを示します。

**優先度 3**

ジョブの優先度が 3 であることを示します。

表 14: ミニ通知アイコン

次のアイコンは、タスクを実行するアクションが行われた後で、ディスプレイに瞬時的に表示されます。

**送信に失敗 (ネガティブ)**

アクションに失敗しました。













	<p>送信に成功 (ポジティブ) アクションに成功しました。</p>
	<p>通信処理中 (経過) 送信中です。これは、通信に成功または失敗したという表示の前に表示されます。</p>

表 15: 送信済みアイテム アイコン 

以下のアイコンは、ディスプレイ右上隅にある送信 BOX フォルダに表示されます。

 また  は	<p>処理中 送信機のエイリアスまたは ID に対するメッセージの送信は保留中で、承認を待っている状態です。 グループのエイリアスまたは ID に対するメッセージの送信が保留中です。</p>
 また  は	<p>読み込まれた個別メッセージまたはグループメッセージ メッセージが読み込まれました。</p>

 また  は	<p>読み込まれていない個別メッセージまたはグループメッセージ メッセージが読み込まれませんでした。</p>
 また  は	<p>送信失敗 テキスト メッセージを送信できません。</p>
 また  は	<p>送信完了 メッセージは正常に送信されました。</p>

LED インジケータ

LED インジケータは、無線機の操作ステータスを示します。

赤色の点滅

電源投入時のセルフ テストに失敗しました。

緊急送信を受信しています。

低バッテリー状態で送信しています。

オートレンジトランスポンダシステムで設定されている通信範囲から外れました。

ミュートモードが有効です。

緑色の点灯

無線機が電源オンになっています。

送信しています。

無線機はページングまたは緊急送信を送信しています。

緑色の点滅

通話またはデータを受信しています。

エア接続プログラミング送信を取得しています。

エア接続アクティビティを検出しています。



注記:

このアクティビティによるプログラム済みチャネルへの影響は、デジタルプロトコルの特性によって異なります。

Capacity Plus のエア接続アクティビティを無線機が検出しているときは、**LED** 表示はありません。

緑色の2回点滅

秘話モード対応通話またはデータを受信しています。

黄色の点灯

従来型チャネルをモニタしています。

無線機が **Bluetooth** 検出可能モードになっています。

黄色の点滅

アクティビティをスキャンしています。

ページングにまだ応答していません。

無線機のフレックス **RX** リストが有効になっています。

すべての **Capacity Plus**-マルチサイトチャネルがビジー状態です。

黄色の2回点滅

自動ローミング機能が有効です。

新規サイトを検索しています。

グループのページングにまだ応答していません。

ロックされています。

Capacity Plus の間は、無線機はリピータに接続されません。

すべての **Capacity Plus** チャネルがビジー状態です。

トーン

以下は、無線機のスピーカから鳴るトーンです。



高いトーン



低いトーン

インジケータ トーン

タスクを実行するアクションが行われた後、インジケータ トーンによりステータスが音声で通知されます。



ポジティブ インジケータ トーン



ネガティブ インジケータ トーン

オーディオ トーン

オーディオ トーンは、無線機の状態や無線機が受信したデータへの応答を音で知らせます。



連続トーン

モノ トーン音。終了まで連続音が鳴ります。



定期トーン

無線機で設定した期間、定期的に音が鳴ります。トーンが開始、中止、反復されます。



反復トーン

ユーザーが停止するまで、シングル トーンが繰り返されます。



瞬間トーン

無線機で設定した短いトーンが 1 回鳴ります。

従来型アナログおよびデジタル モード

無線機の各チャンネルを、従来型アナログ チャンネルか従来型デジタル チャンネルとして設定できます。

チャンネルロッカーを使って、アナログ チャンネルとデジタル チャンネルを切り替えます。

デジタル モードからアナログ モードに切り替えると、一部の機能が使用できなくなります。アナログ モードに切り替えると、デジタル機能の各アイコンが"グレーアウト"します。無効になった機能はメニューに表示されません。

無線機には、アナログとデジタルの両方のモードで利用できる機能もあります。それぞれの機能のわずかな違いが、無線機の性能に影響を及ぼすことはありません。

**注記:**

また、デュアルモードスキャン中には、デジタルモードとアナログモードが切り替わります。詳細については、「[スキャン ページ 410](#)」を参照してください。

アイコン情報

このガイドでは、従来型アナログモードのみの機能、従来型デジタルモードのみの機能、キーパッド対応マイクのみの機能を区別するために、以下のアイコンが使われています。



従来型アナログモードのみの機能を示しています。



従来型デジタルモードのみの機能を示します。

従来型アナログとデジタルの両方のモードで利用可能な機能については、両方のアイコンが表示されません。

IP サイト接続

この機能を使用すると、従来のシングルサイトでは無線機の通信範囲外となる場所でも、インターネットプロトコル (IP) ネットワークを使用して利用可能な別のサイトに接続することで通信できます。これは従来のマルチサイトモードです。

一方のサイトの通信範囲から外れて別のサイトの通信範囲に無線機が移動すると、新しいサイトのリピータに接続して、通話またはデータを送受信します。設定に応じて自動または手動で接続を切り替えます。

自動サイト検索では、現在のサイトからの信号が弱い場合や、無線機が現在のサイトからの信号をまったく検出できない場合に、利用可能サイトをすべてスキャンします。次に、無線機は受信信号強度インジケータ (RSSI) 値が最も強いリピータにロックします。

手動サイト検索では、無線機は、信号強度が最も強いサイトを検索するのではなく、現在通信範囲内にあるローミングリストの次のサイトを検索し、リピータにロックします。

**注記:**

各チャンネルで、スキャンまたはローミングのどちらかを有効にできますが、両方同時に有効にはできません。

この機能が有効になっているチャンネルは、特定ローミングリストに追加されます。自動ローミング動作時にローミングリスト内のチャンネルが検索され、最適なサイトが検出されます。ローミングリストでは、最大 16 チャンネルを使用できます (選択したチャンネルを含む)。

**注記:**

手動では、ローミングリスト内のエントリの追加や削除はできません。詳細については、ディーラーまたはシステム管理者にご確認ください。

Capacity Plus—シングルサイト

Capacity Plus—シングルサイトは、MOTOTRBO 無線機システムのシングルサイト トランキング構成であり、多数のユーザーと最大で 254 のグループをサポートするためのチャンネルプールを使用します。この機能を使用すると、リピータモードのとき、お使いの無線機でプログラムされたチャンネル数を有効活用できます。

Capacity Plus—シングルサイトでは利用できない機能に、プログラム可能ボタンからアクセスしようとする、ネガティブインジケータトーンが鳴ります。

無線機には、従来型デジタルモード、IP Site Connect、および Capacity Plus のいずれのモードでも利用できる機能

もあります。ただし、それぞれの機能のわずかな違いが、無線機の性能に影響を及ぼすことはありません。

この設定の詳細については、ディーラーかシステム管理者にご確認ください。

Capacity Plus—マルチサイト

Capacity Plus—マルチサイトは、Capacity Plus と IP Site Connect 構成の優れた特徴を組み合わせた MOTOTRBO 無線機システムのマルチチャンネル トランキング構成です。

この機能を使用すると、無線機は IP ネットワーク経由で接続されている別の利用可能サイトに接続するので、シングルサイトでは通信範囲外となる地域との トランキング通信が可能になります。また、各利用可能サイトでサポートされているプログラム済みチャンネルは、組み合わせられて効率的に利用されるため、容量も増加します。

一方のサイトの通信範囲から外れて別のサイトの通信範囲に無線機が移動すると、新しいサイトのリピータに接続して、通話またはデータを送受信します。設定に応じて、この切り替えは自動や手動で行われます。

無線機がこの切り替えを自動的に行うように設定されている場合、現在のサイトからの信号が弱くなったり、無線機が現在のサイトから信号をまったく検出できなくなった場合に、無線機はすべての利用可能サイトをスキャンします。

その後、無線機は RSSI 値が最も強いリピータにロックします。

手動サイト検索では、無線機はローミングリスト内を検索して、現在通信範囲内にある次のサイト (ただし、信号強度が最も強いサイトとは限らない) を見つけ、そのサイトにロックします。

この機能が有効になっているチャンネルは、特定ローミングリストに追加されます。無線機は、自動ローミング動作時にこれらのチャンネルを検索し、最適なサイトを見つけます。

**注記:**

ローミングリストへのエントリの追加や削除は手動では行えません。詳細については、ディーラーまたはシステム管理者にご確認ください。

Capacity Plus—シングルサイトと同様に、Capacity Plus—マルチサイトに該当しない機能のアイコンはメニューで使用できません。プログラム可能ボタンから Capacity Plus—マルチサイトでは利用できない機能にアクセスしようとする、ネガティブインジケータトーンが鳴ります。

ゾーンとチャンネルの選択

この章では、無線機でゾーンまたはチャンネルを選択する操作について説明します。ゾーンとは、チャンネルのグループのことです。





無線機は最大 99 チャンネルと 2 ゾーンをサポートします。1 ゾーンの最大チャンネル数は 99 です。



それぞれのチャンネルでは、異なる機能をプログラムすることも、異なるユーザーグループをサポートすることもできます。

ゾーンの選択

下記の手順に従って、無線機で必要なゾーンを選択します。





- 1 以下のいずれか 1 つの手順を実行します。
 - プログラムされた **[ゾーンせんたく]** ボタンを押します。ステップ 3 に進みます。
 -  を押してメニューにアクセスします。

- 2  または  を押して **[ゾーン]** に移動します。 を押して選択します。
ディスプレイに  と現在のゾーンが表示されます。

- 3  または  を押して必要なゾーンに移動します。  を押して選択します。
- ディスプレイに【<ゾーン> せんたくずみ】が一時的に表示され、すぐに選択されたゾーンの画面に戻ります。
-

エイリアス検索を使用したゾーンの選択

下記の手順に従って、エイリアス検索を使用して、無線機で必要なゾーンを選択します。

- 1  を押してメニューにアクセスします。
-
- 2  または  を押して【ゾーン】に移動します。  を押して選択します。
- ディスプレイに  と現在のゾーンが表示されます。
-

- 3 必要なエイリアスの最初の文字を入力します。
- ディスプレイに表示されているカーソルが点滅しなくなります。
-

- 4 必要なエイリアスの残りの文字を入力します。
- エイリアス検索では、大文字と小文字が区別されません。同じ名前のエントリが2つ以上ある場合、リストの最初に記載されたエントリがディスプレイに表示されます。
- テキスト行の1行目に入力した文字が表示されます。テキスト行の次の行に検索結果の短い一覧が表示されます。
-

- 5  を押して選択します。
- ディスプレイに【<ゾーン> せんたくずみ】が一時的に表示され、すぐに選択されたゾーンの画面に戻ります。
-

チャンネル選択

ゾーンの選択後、下記の手順に従って、無線機に必要なチャンネルを選択します。

以下のいずれか 1 つの手順を実行します。

- スクロールアップ/スクロール ダウン ボタンを押します。
- 音量/チャンネル ノブを使用します。
- プログラムされた **[チャンネル アップ/チャンネル ダウン]** ボタンを押します。

通話

この章では、通話の受信、応答、発信、停止の操作について説明します。

以下の機能のいずれかを使用してチャンネルを選択した後、無線機のエイリアスまたは ID、あるいはグループのエイリアスまたは ID を選択できます。

エイリアス検索

この方法は、キーパッド マイクを併用して、グループコール、個別コール、および一斉コールのみに使用します。

連絡先リスト

この方法では、連絡先リストに直接アクセスできます。

ダイヤル (連絡先を使用)

この方法は、キーパッド マイクを併用して、個別コールおよび通話のみに使用します。

プログラム可能な数値キー

この方法は、キーパッド マイクを併用して、グループコール、個別コール、および一斉コールのみに使用します。



注記:

各数値キーに割り当てできるのは単一のエイリアスまたは ID ですが、単一のエイリアスまたは ID は、複数の数値キーに関連付けできます。キーパッド マイクのすべての数値キーに割り当てできます。詳細については、「[プログラム可能な数値キーへのエントリの割り当て ページ 415](#)」を参照してください。

プログラムされた **[ワン タッチ アクセス]** ボタン

この方法は、グループコール、個別通話、および電話通話のみに使用します。

ワン タッチ アクセス ボタンでは、プログラム可能ボタンの短押しまたは長押しに、それぞれ単一の ID のみを割り当てできます。お使いの無線機で、複数の **[ワン タッチ アクセス]** ボタンをプログラムできます。

プログラム可能ボタン

この方法は、通話のみに使用します。

音量/チャンネルセレクタノブ

この方法では、無線機のエイリアスまたは ID、あるいはグループのエイリアスまたは ID が手動で選択されます。

無線機が送信している間は緑色の LED が点灯し、無線機が受信している間は緑色に点滅します。



注記:

無線機が送信している間は緑色の LED が点灯し、無線機が秘話対応通話を受信している際には 2 回点滅します。

秘話対応通話のスクランブルを解除するには、無線機に送信側無線機 (受信中の通話の相手) と同一のプライバシーキー、または同一のキー値とキー ID (ディーラーがプログラミング) が設定されている必要があります。

詳細については、「[プライバシー ページ 468](#)」を参照してください。

グループ通話

ユーザーグループとの通話を受信/発信するには、無線機をそのグループの所属に設定する必要があります。

グループ通話の発信

下記の手順に従って、無線機でグループコールを発信します。

- 1 以下のいずれか 1 つの手順を実行します。
 - アクティブなグループのエイリアスまたは ID のチャンネルを選択します。
 - プログラムされた [**ワンタッチアクセス**] ボタンを押します。

-
- 2 **PTT** ボタンを押して通話を発信します。

緑色の LED が点灯します。ディスプレイに、**グループコールアイコン**と**グループコールエイリアス**が表示されます。

-
- 3 相手の声を聞くには、**PTT** ボタンを放します。

相手先の無線機が応答すると、LED が緑色に点灯します。ディスプレイに **グループコールアイコン**、**グループのエイリアスまたは ID** と、送信側無線機のエイリアスまたは ID が表示されます。







-
- 4  **チャンネルフリー指示機能**が有効な場合、送信無線機で [**PTT**] ボタンが離された瞬間に、短い警告トーン

ンが鳴ります。これは、そのチャンネルが応答できるようになったことを示します。電話に応答するには、**[PTT]** ボタンを押します。

音声アクティビティがないまま、事前に定められた時間が経過すると、通話が終了します。通話を開始する前の画面に戻ります。

連絡先リストを使用したグループコールの発信

下記の手順に従って、連絡先リストを使用して無線機でグループコールを発信します。

- 1  を押してメニューにアクセスします。
- 2  または  を押して『れんらくさき』に移動します。  を押して選択します。
- 3  または  を押して必要なエイリアスまたは ID に移動します。  を押して選択します。

- 4 **PTT** ボタンを押して通話を発信します。
緑色の LED が点灯します。

- 5 相手の声を聞くには、**PTT** ボタンを放します。
グループ内のユーザーが応答すると、LED が緑色に点滅します。ディスプレイに **[グループコール]** アイコン、エイリアスまたは ID と、送信側無線機のエイリアスまたは ID が表示されます。

- 6  チャンネルフリー指示機能が有効な場合、送信無線機で **[PTT]** ボタンが離された瞬間に、短い警告トーンが鳴ります。これは、そのチャンネルが応答できるようになったことを示します。電話に応答するには、**[PTT]** ボタンを押します。
音声アクティビティがないまま、事前に定められた時間が経過すると、通話が終了します。

プログラム可能な数値キーを使用したグループ コールの発信

下記の手順に従って、プログラム可能な数値キーを使用して無線機でグループ コールを発信します。

- 1 ホーム画面が表示されている場合、プログラム可能な数値キーを長く押すと、事前に定義されたエイリアスまたは ID が表示されます。

数値キーが特定のモードのエントリに割り当てられている場合、別のモードで数値キーを長く押しても、この機能は使用できません。

数値キーがエントリに割り当てられていない場合、ネガティブ インジケータ トーンが鳴ります。

- 2 **PTT** ボタンを押して通話を発信します。
緑色の LED が点灯します。

- 3 相手の声を聞くには、**PTT** ボタンを放します。
グループ内のユーザーが応答すると、LED が緑色に点滅します。

- 4  チャンネル フリー指示機能が有効な場合、送信無線機で **[PTT]** ボタンが離された瞬間に、短い警告トーン

が鳴ります。これは、そのチャンネルが応答できるようになったことを示します。電話に応答するには、**[PTT]** ボタンを押します。

音声アクティビティがないまま、事前に定められた時間が経過すると、通話が終了します。通話を開始する前の画面に戻ります。

詳細については、「[プログラム可能な数値キーへのエントリの割り当て ページ 415](#)」を参照してください。

グループ コールへの応答



ユーザー グループからの通話を受信するには、無線機がそのグループの一部として設定されている必要があります。下記の手順に従って、無線機でグループ コールに応答します。

グループ コールを受信した場合:

- 緑色の LED が点滅します。
- ディスプレイの右上隅に **[グループ コール]** アイコンが表示されます。
- テキスト行の 1 行目に発信者のエイリアスが表示されます。
- テキスト行の 2 行目に、グループ コール エイリアスが表示されます。

- 無線機のミュートが解除され、着信通話の音はスピーカから聞こえます。

1 以下のいずれか 1 つの手順を実行します。

-  チャンネルフリー指示機能が有効な場合、送信無線機で **[PTT]** ボタンが離された瞬間に、短い警告トーンが鳴ります。これは、そのチャンネルが応答できるようになったことを示します。電話に応答するには、**[PTT]** ボタンを押します。
-  音声割り込み機能が有効になっている場合、**[PTT]** ボタンを押して送信側無線機から音声に割り込んで、応答できるようにそのチャンネルを解放します。

緑色の LED が点灯します。

2 以下のいずれか 1 つの手順を実行します。

- 通話許可トーンが完了するまで待機し、マイクに向かってはっきりと話します (有効な場合)。
-  **PTT** サイドトーンが完了するまで待機し、マイクに向かってはっきりと話してください (有効な場合)。

3 相手の声を聞くには、**PTT** ボタンを放します。

音声アクティビティがないまま、事前に定められた時間が経過すると、通話が終了します。

無線機が、ホーム画面以外の画面でグループ コールを受信すると、通話に応答するまでその画面のままとなります。

応答前に発信者のエイリアスを確認するには、 ボタンを長押ししてホーム画面に戻ります。

個別コール

個別コールとは、1 台の無線機から別の 1 台の無線機への通話です。

個別コールには、2 つの設定方法があります。1 つは、無線機プレゼンス チェックの後で通話をセットアップする方法で、もう 1 つは通話を即座に設定する方法です。ディーラーは、これらのタイプのいずれか 1 つのみを無線機にプログラムできます。

個別通話の発信

個別通話を開始するには無線機をプログラムする必要があります。この機能が無効な場合に通話を開始すると、ネガ

ティブ インジケータ トーンが鳴ります。下記の手順に従って、無線機で個別コールを発信します。

個々の無線機に連絡するには、テキスト メッセージまたはページング機能を使用します。詳細については、[テキストメッセージング ページ 148](#) または [ページング操作 ページ 426](#) を参照してください。

- 1 以下のいずれか 1 つの手順を実行します。
 - アクティブな無線機のエイリアスまたは ID のチャンネルを選択します。
 - プログラムされた **[ワンタッチ アクセス]** ボタンを押します。

-
- 2 **PTT** ボタンを押して通話を発信します。

緑色の LED が点灯します。ディスプレイに **こべつコール アイコン**、無線機のエイリアス、通話ステータスが表示されます。

-
- 3 通話許可トーンが完了するまで待機し、マイクに向かってはっきりと話します (有効な場合)。

- 4 相手の声を聞くには、**PTT** ボタンを放します。

相手先の無線機が応答すると、LED が緑色に点滅します。



-
- 5  チャンネルフリー指示機能が有効な場合、送信無線機で **[PTT]** ボタンが離された瞬間に、短い警告トーンが鳴ります。これは、そのチャンネルが応答できるようになったことを示します。電話に応答するには、**[PTT]** ボタンを押します。



音声アクティビティがないまま、事前に定められた時間が経過すると、通話が終了します。トーンが鳴ります。ディスプレイに **【コールしゅうりょう】** と表示されます。

連絡先リストを使用した個別コールの発信

下記の手順に従って、連絡先リストを使用して無線機で個別コールを発信します。

- 1  を押してメニューにアクセスします。

2  または  を押して【れんらくさき】に移動します。  を押して選択します。

3  または  を押して必要なエリアまたは ID に移動します。  を押して選択します。

4 **PTT** ボタンを押して通話を発信します。
緑色の **LED** が点灯します。宛先のエリアが表示されます。

5 通話許可トーンが完了するまで待機し、マイクに向かってはっきりと話します (有効な場合)。

6 相手の声を聞くには、**PTT** ボタンを放します。
相手先の無線機が応答すると、**LED** が緑色に点滅します。ディスプレイに送信ユーザーのエリアまたは ID が表示されます。

7  チャンネルフリー指示機能が有効な場合、送信無線機で **[PTT]** ボタンが離された瞬間に、短い警告トーンが鳴ります。これは、そのチャンネルが応答できる



ようになったことを示します。電話に応答するには、**[PTT]** ボタンを押します。



音声アクティビティがないまま、事前に定められた時間が経過すると、通話が終了します。トーンが鳴ります。ディスプレイに【コールしゅうりょう】と表示されます。



ダイアルを使用した個別コールの発信

下記の手順に従って、ダイアルを使用して無線機で個別コールを発信します。



1  を押してメニューにアクセスします。

2  または  を押して【れんらくさき】に移動します。  を押して選択します。

3  または  を押して【ダイアル】に移動します。  を押して選択します。

4  または  を押して『むせんきばんごう』に移動します。  を押して選択します。

5 以下のいずれか 1 つの手順を実行します。

- 無線機の ID を入力し、  を押して先に進みます。
 - 前にダイアルした無線機の ID を編集し、  を押して先に進みます。
-

6 **PTT** ボタンを押して通話を発信します。

緑色の **LED** が点灯します。宛先のエイリアスが表示されます。

7 通話許可トーンが完了するまで待機し、マイクに向かってはっきりと話します (有効な場合)。

8 相手の声を聞くには、**PTT** ボタンを放します。

相手先の無線機が応答すると、**LED** が緑色に点灯します。ディスプレイに送信ユーザーのエイリアスまたは ID が表示されます。

9  チャンネルフリー指示機能が有効な場合、送信無線機で **[PTT]** ボタンが離された瞬間に、短い警告トーンが鳴ります。これは、そのチャンネルが応答できるようになったことを示します。電話に応答するには、**[PTT]** ボタンを押します。

音声アクティビティがないまま、事前に定められた時間が経過すると、通話が終了します。トーンが鳴ります。ディスプレイに『コールしゅうりょう』と表示されます。

プログラム可能な数値キーを使用した個別コールの発信

下記の手順に従って、プログラム可能な数値キーを使用して無線機で個別コールを発信します。

1 ホーム画面が表示されている場合、プログラム可能な数値キーを長く押すと、事前に定義されたエイリアスまたは ID が表示されます。

数値キーが特定のモードのエントリに割り当てられている場合、別のモードで数値キーを長く押しても、この機能は使用できません。

数値キーがエントリに割り当てられていない場合、ネガティブインジケータトーンが鳴ります。

2 PTT ボタンを押して通話を発信します。

緑色の LED が点灯します。ディスプレイの右上隅に、**[こべつ コール]** アイコンが表示されます。テキスト行の 1 行目に発信者のエイリアスが表示されません。テキスト行の 2 行目に通話ステータスが表示されます。

3 相手の声を聞くには、PTT ボタンを放します。

相手先の無線機が応答すると、LED が緑色に点滅します。宛先のエイリアスが表示されます。

4 チャネルフリー指示機能が有効な場合、送信無線機で [PTT] ボタンが離された瞬間に、短い警告トーンが鳴ります。これは、そのチャネルが応答できるようになったことを示します。電話に応答するには、[PTT] ボタンを押します。

音声アクティビティがないまま、事前に定められた時間が経過すると、通話が終了します。トーンが鳴ります。通話を開始する前の画面に戻ります。

詳細については、「[プログラム可能な数値キーへのエントリの割り当て ページ 415](#)」を参照してください。



個別コールへの応答

下記の手順に従って、無線機で個別コールに応答します。

個別コールを受信した場合:

- 緑色の LED が点滅します。
- 無線機のミュートが解除され、着信通話の音はスピーカから聞こえます。

1 以下のいずれか 1 つの手順を実行します。

-  チャネルフリー指示機能が有効な場合、送信無線機で [PTT] ボタンが離された瞬間に、短い警告トーンが鳴ります。これは、そのチャネルが応答できるようになったことを示します。電話に応答するには、[PTT] ボタンを押します。
-  強制停止機能が有効になっている場合、[PTT] ボタンを押して進行中の割り込み可能通話を停止して、応答できるようにそのチャネルを解放します。

緑色の LED が点灯します。

2 通話許可トーンが完了するまで待機し、マイクに向かってはっきりと話します (有効な場合)。

3 相手の声を聞くには、PTT ボタンを放します。

音声アクティビティがないまま、事前に定められた時間が経過すると、通話が終了します。

一斉コール

一斉コールとは、ある無線機からチャンネルの各無線機への通話を指します。一斉コールは、ユーザーの注意を十分に促す必要がある重要な通知に使用されます。チャンネルのユーザーは、一斉コールには応答できません。

一斉コールの受信

一斉コールを受信した場合:

- トーンが鳴ります。
- 緑色の LED が点滅します。
- ディスプレイの右上隅に **[グループコール]** アイコンが表示されます。
- テキスト行の **1** 行目に発信者のエイリアス ID が表示されます。
- テキスト行の **2** 行目に、**[いっせいコール]** と表示されます。
- 無線機のミュートが解除され、着信通話の音はスピーカーから聞こえます。

通話が終了すると、無線機は一斉コールを受信する前の画面に戻ります。

一斉コールの場合、事前に定めた終了前の待機時間は適用されません。

● チャンネルフリー指示機能が有効になっている場合、送信側無線機が **[PTT]** ボタンを放したときに、短い警告トーンが鳴ります。これは、そのチャンネルが使用できるようになったことを示しています。

一斉コールには応答できません。



注記:

通話を受信中に別のチャンネルに切り替えると、無線機は一斉コールの受信を停止します。一斉コールが終了するまでは、メニューナビゲーションや編集はできません。

一斉コールの発信

一斉コールを発信するには無線機をプログラムする必要があります。下記の手順に従って、無線機で一斉コールを発信します。

- 1 アクティブな一斉コールグループのエイリアスまたは ID があるチャンネルを選択します。
-

2 PTT ボタンを押して通話を発信します。

緑色の LED が点灯します。ディスプレイに、**グループコール** アイコンと【いっせいコール】が表示されます。

3 以下のいずれか 1 つの手順を実行します。

- 通話許可トーンが完了するまで待機し、マイクに向かってはっきりと話します (有効な場合)。
-  **PTT** サイドトーンが完了するまで待機し、マイクに向かってはっきりと話してください (有効な場合)。

チャンネルのユーザーは、一斉コールには応答できません。

プログラム可能な数値キーを使用した一斉コールの発信

下記の手順に従って、プログラム可能な数値キーを使用して無線機で一斉コールを発信します。

- 1** ホーム画面が表示されている場合、事前に定義されたエイリアスまたは ID に割り当てられたプログラム可能な数値キーを長く押します。

数値キーが特定のモードのエントリに割り当てられている場合、別のモードで数値キーを長く押しても、この機能は使用できません。

数値キーがエントリに割り当てられていない場合、ネガティブ インジケータ トーンが鳴ります。

2 PTT ボタンを押して通話を発信します。

緑色の LED が点灯します。

3 相手の声を聞くには、**PTT** ボタンを放します。

相手先の無線機が応答すると、LED が緑色に点灯します。現時点では、一斉コールに応答することはありません。

- 4**  チャンネルフリー指示機能が有効な場合、送信無線機で **[PTT]** ボタンが離された瞬間に、短い警告トーンが鳴ります。これは、そのチャンネルが応答できるようになったことを示します。電話に応答するには、**[PTT]** ボタンを押します。

音声アクティビティがないまま、事前に定められた時間が経過すると、通話が終了します。通話を開始する前の画面に戻ります。個別コールの場合は、コール終了時に短い音が聞こえます。

詳細については、「プログラム可能な数値キーへのエントリの割り当て ページ 415」を参照してください。

選択コール

選択コールとは、1 台の無線機から別の 1 台の無線機への通話です。アナログシステムでは、個別コールです。

選択コールの発信

選択コールを開始するには無線機をプログラムする必要があります。下記の手順に従って、無線機で選択コールを発信します。

- 1 アクティブな無線機のエイリアスまたは ID のチャンネルを選択します。

- 2 **PTT** ボタンを押して通話を発信します。

緑色の LED が点灯します。ディスプレイに **こべつコール** アイコン、無線機のエイリアス、通話ステータスが表示されます。

- 3 以下のいずれか 1 つの手順を実行します。

- 通話許可トーンが完了するまで待機し、マイクに向かってはっきりと話します (有効な場合)。

-  **PTT** サイドトーンが完了するまで待機し、マイクに向かってはっきりと話してください (有効な場合)。

- 4 相手の声を聞くには、**PTT** ボタンを放します。

相手先の無線機が応答すると、LED が緑色に点灯します。

- 5  チャンネルフリー指示機能が有効な場合、送信無線機で **[PTT]** ボタンが離された瞬間に、短い警告トーンが鳴ります。これは、そのチャンネルが応答できるようになったことを示します。電話に応答するには、**[PTT]** ボタンを押します。

音声アクティビティがないまま、事前に定められた時間が経過すると、通話が終了します。

- 6 ディスプレイに [コールしゅうりょう] と表示されます。

選択コールへの応答

下記の手順に従って、無線機で選択コールに応答します。

選択コールを受信した場合:

- 緑色の LED が点滅します。

- 最初のテキスト行には、**[個別コール]** アイコンと発信者のエイリアス、または **[せんとくコール]** か **[ページング コール]** が表示されます。
- 無線機のミュートが解除され、着信通話の音はスピーカから聞こえます。

1 電話に応答するには、**[PTT]** ボタンを押します。
緑色の LED が点灯します。

2 通話許可トーンが完了するまで待機し、マイクに向かってはっきりと話します (有効な場合)。

3 相手の声を聞くには、**PTT** ボタンを放します。
音声アクティビティがないまま、事前に定められた時間が経過すると、通話が終了します。トーンが鳴ります。ディスプレイに **[コールしゅうりょう]** と表示されます。

電話通話

電話通話は、個別の無線機から電話機への通話です。

無線機で電話通話機能が有効になっていない場合:

- ディスプレイに **[りようふか]** と表示されます。

- 無線機の通話がミュートされます。
- 通話が終了すると、前の画面に戻ります。

電話通話中、次の場合に通話が終了します。

- 事前に設定されているディアクセス コードを使用して **ワンタッチ アクセス** ボタンを押す。
- 追加の数字の入力としてディアクセス コードを入力する。

チャンネル アクセス中、コードのアクセス/アクセス解除中、または追加の数字の送信中、無線機は **オン/オフ**、**音量コントロール**、および **チャンネル セレクタ** の各ボタンやノブにのみ反応します。無効な入力を行うたびにトーンが鳴ります。

チャンネル アクセス中に  を押すと、コール試行が解除されます。トーンが鳴ります。



注記:

アクセス コードまたはディアクセス コードは 10 文字以下にする必要があります。

詳細については、ディーラーまたはシステム管理者にご確認ください。

電話通話の発信

下記の手順に従って、無線機で通話を発信します。

- 1 プログラムされた **[ワンタッチ アクセス]** ボタンを押して、事前に定義されたエイリアスまたは ID に移動します。

ワンタッチ アクセス ボタンのエントリが空の場合、ネガティブ インジケータ トーンが鳴ります。アクセス コードが **[れんらくさき]** リストで事前に設定されていない場合、ディスプレイに **【アクセスコード:】** と表示されます。

- 2 アクセス コードを入力し、**[OK]** を押して先に進みます。

アクセス コードまたはディアクセス コードは **10** 文字以下にする必要があります。

- 3 電話に応答するには、**[PTT]** ボタンを押します。相手の声を聞くには、**PTT** ボタンを放します。

- 4 通話中に追加の数字を入力する必要がある場合、

[OK] を押して先に進みます。

通話中に必要な追加の数字を入力している間に通話が終了した場合、通話を開始する前の画面に戻ります。

デュアルトーン マルチ周波数 (DTMF) トーンが鳴ります。前の画面に戻ります。

- 5 通話を終了するには、**[📞]** を押します。

- 6 以下のいずれか **1** つの手順を実行します。

- ディアクセス コードが事前に設定されていない場合は、ディスプレイに **【ディアクセスコード:】** と表示されたらディアクセス コードを入力し、

[OK] を押して先に進みます。
前の画面に戻ります。

- プログラムされた **[ワンタッチ アクセス]** ボタンを押します。
ワンタッチ アクセス ボタンのエントリが空の場合、ネガティブ インジケータ トーンが鳴ります。

DTMF トーンが鳴り、ディスプレイに **【でんわせつだん】** と表示されます。

通話が正常に終了した場合:

- トーンが鳴ります。







- ディスプレイに【コールしゅうりょう】と表示されます。

通話が正常に終了しなかった場合、無線機は通話画面に戻ります。最後の2つの手順を繰り返すか、電話機ユーザーが通話を終了するまで待ちます。

連絡先リストを使用した電話通話の発信



下記の手順に従って、連絡先リストを使用して無線機で通話を発信します。



- 1  を押してメニューにアクセスします。
- 2  または  を押して【れんらくさき】に移動します。  を押して選択します。
ディスプレイにアルファベット順でエントリが表示されます。
- 3  または  を押して必要なエイリアスまたは ID に移動します。  を押して選択します。

通話連絡先画面で **PTT** ボタンを押した場合:

- ディスプレイの1行目に【ばんごう:】と表示されます。
- ディスプレイの2行目に、点滅するカーソルが表示されます。

選択したエントリが空の場合:

- ネガティブインジケータトーンが鳴ります。
- ディスプレイに【つうわむこうなばんごう】と表示されます。

-
- 4  または  を押して【つうわ】に移動します。  を押して選択します。

アクセスコードが事前に設定されていない場合、ディスプレイに【アクセスコード:】と表示されます。

-
- 5 アクセスコードを入力し、  を押して先に進みます。

アクセスコードまたはディアクセスコードは 10 文字以下にする必要があります。

テキスト行の 1 行目に【よびだしちゅう】と表示されます。ディスプレイの 2 行目に無線機のエイリアスまたは ID と、【電話】アイコンが表示されます。通話に成功した場合:

- DTMF トーンが鳴ります。
- 電話機ユーザーのダイアルトーンが聞こえます。
- テキスト行の 1 行目に無線機のエイリアスまたは ID と、【RSSI】アイコンが表示されます。
- テキスト行の 2 行目に【でんわ】と、【電話】アイコンが表示されます。

通話に失敗した場合:

- トーンが鳴ります。
- ディスプレイに【でんわ NG】と表示されてから、【アクセスコード:】と表示されます。
- アクセスコードが連絡先リストで事前に設定されている場合、通話を開始する前の画面に戻りません。

- 6 電話に応答するには、【PTT】ボタンを押します。
【RSSI】アイコンが消えます。

- 7 相手の声を聞くには、【PTT】ボタンを放します。

- 8 通話中に追加の数字を入力する必要がある場合、
【OK】を押して先に進みます。

通話中に必要な追加の数字を入力している間に通話が終了した場合、通話を開始する前の画面に戻りません。

DTMF トーンが鳴ります。前の画面に戻ります。

- 9 通話を終了するには、【】を押します。

- 10 ディアクセスコードが事前に設定されていない場合は、ディスプレイに【ディアクセスコード:】と表示されたらディアクセスコードを入力し、【OK】を押して先に進みます。

前の画面に戻ります。DTMF トーンが鳴り、ディスプレイに【でんわせつだん】と表示されます。通話が正常に終了した場合:

- トーンが鳴ります。

- ディスプレイに【コールしゅうりょう】と表示されます。

通話が正常に終了しなかった場合、無線機は通話画面に戻ります。ステップ 9 と ステップ 10 を繰り返すか、電話機ユーザーが通話を終了するまで待ちます。電話連絡先画面で **PTT** ボタンを押すと、トーンが鳴り、ディスプレイに【コール >OK】と表示されます。

電話機ユーザーが通話を終了するとトーンが鳴り、ディスプレイに【でんわしゅうりょう】と表示されます。

電話通話でリクエストされた追加の数字を入力している間に通話が終了した場合、その通話を開始する前の画面に戻ります。



注記:





チャンネルアクセス中に  を押すと、コール試行が解除され、トーンが鳴ります。



コール中、ディアクセス コードが事前設定されている状態で **ワンタッチアクセス** ボタンを押すか、追加の数字の入力としてディアクセス コードを入力すると、コールの終了が試行されます。



チャンネルアクセスおよびアクセス/ディアクセス コードまたは追加の数字の送信中、無線機は **オン/オフ** ボタン、**音量コントロールノブ**、および **チャンネルロッカー** にのみ反応します。無効な入力を行うたびにトーンが鳴ります。

ダイヤルを使用した電話通話の発信

下記の手順に従って、ダイヤルを使用して無線機で通話を発信します。

-  を押してメニューにアクセスします。
-  または  を押して【れんらくさき】に移動します。  を押して選択します。

3  または  を押して【ダイアル】に移動します。  を押して選択します。

4  または  を押して【ばんごう】に移動します。  を押して選択します。

ディスプレイに【ばんごう:】と表示され、カーソルが点滅します。

5 電話番号を入力し、  を押して先に進みます。

アクセスコードが事前に設定されていない場合、ディスプレイに【アクセスコード:】と表示され、カーソルが点滅します。

6 アクセスコードを入力し、  を押して先に進みます。

アクセスコードまたはディアクセスコードは 10 文字以下にする必要があります。

7 緑色の LED が点灯します。ディスプレイの右上隅に【電話】アイコンが表示されます。テキスト行の 1

行目に無線機のエイリアスが表示されます。テキスト行の 2 行目に通話ステータスが表示されます。通話に成功した場合:

- DTMF トーンが鳴ります。
- 電話機ユーザーのダイアルトーンが聞こえます。
- テキスト行の 1 行目に無線機のエイリアスが表示されます。
- ディスプレイの右上隅に【電話】アイコンが引き続き表示されます。

通話に失敗した場合:

- トーンが鳴ります。
 - ディスプレイに【でんわ NG】と表示されてから、【アクセスコード:】と表示されます。
 - アクセスコードが連絡先リストで事前に設定されている場合、通話を開始する前の画面に戻ります。
-

8 通話を終了するには、  を押します。

9 以下のいずれか 1 つの手順を実行します。

- ディアクセス コードが事前に設定されていない場合は、ディスプレイに【ディアクセスコード:】と表示されたらディアクセス コードを入力し、
 を押して先に進みます。
前の画面に戻ります。
- プログラムされた【ワンタッチ アクセス】ボタンを押します。
ワンタッチ アクセス ボタンのエントリが空の場合、ネガティブ インジケータ トーンが鳴ります。

DTMF トーンが鳴り、ディスプレイに【でんわせつだん】と表示されます。

通話が正常に終了した場合:

- トーンが鳴ります。
- ディスプレイに【コールしゅうりょう】と表示されます。

通話が正常に終了しなかった場合、無線機は通話画面に戻ります。ステップ 8 を繰り返します (または電話機ユーザーが通話を終了するまで待ちます)。



注記:

通話連絡先画面で **PTT** ボタンを押すと、トーンが鳴り、ディスプレイに【コール 〉OK】と表示されます。

電話機ユーザーが通話を終了するとトーンが鳴り、ディスプレイに【コールしゅうりょう】と表示されます。

通話でリクエストされた追加の数字を入力している間に通話が終了した場合、そのコールを開始する前の画面に戻ります。







チャンネル アクセス中に  を押すと、コール試行が解除され、トーンが鳴ります。

コール中、ディアクセス コードが事前設定されている状態でワンタッチ アクセス ボタンを押すか、追加の数字の入力としてディアクセス コードを入力すると、コールの終了が試行されます。





チャンネル アクセスおよびアクセス/ディアクセス コードまたは追加の数字の送信中、無線機はオン/オフ ボタン、音量コントロール ノブ、およびチャンネル ロッカーにのみ反応します。無効な入力を行うたびにトーンが鳴ります。



エイリアス検索を使用したグループコール、個別コール、無線機通話、または一斉コールの発信

下記の手順に従って、エイリアス検索を使用して通話を発信します。

- 1  を押してメニューにアクセスします。
- 2  または  を押して [れんらくさき] に移動します。  を押して選択します。
ディスプレイにアルファベット順でエントリが表示されます。
- 3  または  を押して必要な無線機のエイリアスまたは ID に移動します。ディスプレイの 1 行目に [ばんごう:] と表示されます。ディスプレイの 2 行目に、点滅するカーソルが表示されます。キーパッドを使用して、電話番号を入力します。
- 4  を押して選択します。選択したエントリが空の場合、ネガティブインジケータトーンが鳴り、デ

ィスプレイに [つうわむこうなばんごう] と表示されます。



- 5  または  を押して [通話] に移動し、  を押して選択します。アクセスコードが連絡先リストで事前に設定されていない場合、ディスプレイの 1 行目に [アクセスコード:] と表示されます。ディスプレイの 2 行目に、点滅するカーソルが表示されます。アクセスコードを入力し、  ボタンを押して先に進みます。成功すると、DTMF トーンが鳴ります。電話機ユーザーのダイアルトーンが聞こえます。ディスプレイの 1 行目に、無線機のエイリアスまたは ID と [RSSI] アイコンが表示されます。ディスプレイの 2 行目に [でんわつうわ] および [電話通話] アイコンが表示されます。失敗の場合、トーンが鳴り、ディスプレイに [でんわ NG] と表示されます。アクセスコード入力画面に戻ります。アクセスコードが [れんらくさき] リストで事前に設定されている場合、そのコールを開始する前の画面に戻ります。
- 6 話すときには **PTT** ボタンを押し、聞くときにはボタンを放します。送信中は [RSSI] アイコンが消えます。

- 7 電話通話中に追加の数字を入力する必要がある場合は、次のいずれか 1 つの手順を実行します。
- キーボードのいずれかのキーを押し、追加の数字の入力を始めます。ディスプレイの 1 行目に【つかケタ:】と表示されます。ディスプレイの 2 行目に、点滅するカーソルが表示されます。残りの数字を入力し、 を押して、先に進みます。DTMF トーンが鳴り、前の画面に戻ります。
 - **ワンタッチ アクセス** ボタンを押します。DTMF トーンが鳴ります。**ワンタッチ アクセス** ボタンのエントリが空の場合、ネガティブインジケータトーンが鳴ります。
- 8 通話を終了するには、 を押します。アクセスコードが連絡先リストで事前に設定されていない場合、ディスプレイの 1 行目に【ディアクセス コード:】と表示されます。ディスプレイの 2 行目に、点滅するカーソルが表示されます。ディアクセスコードを入力し、 を押して先に進みます。前の画面に戻ります。DTMF トーンが鳴り、ディスプレイに【でんわせつだん】と表示されます。成功の場合、トーンが鳴り、ディスプレイに【でんわしゅうりょう】と表示されます。電話通話画面に戻ります。失敗した場合、無線機は電話通話画面に戻ります。電話連

絡先画面で **PTT** ボタンを押すと、トーンが鳴り、ディスプレイに【コール >OK】と表示されます。電話機ユーザーが通話を終了するとトーンが鳴り、ディスプレイに【でんわしゅうりょう】と表示されます。電話通話でリクエストされた追加の数字を入力している間に通話が終了した場合、その通話を開始する前の画面に戻ります。



注記:

チャンネルアクセス中に  を押すと、コール試行が解除され、トーンが鳴ります。エイリアス検索を終了するには、 または  を押します。コール中、ディアクセスコードが事前設定されている場合 **ワンタッチ アクセス** ボタンを押すか、追加の数字の入力としてディアクセスコードを入力すると、コールの終了が試行されます。チャンネルアクセスおよびアクセス/ディアクセスコードまたは追加の数字の送信中、無線機は【オン/オフ】ボタン、音量コントロールノブ、およびチャンネルロッカーにのみ反応します。無効な入力を行うたびにトーンが鳴ります。

デュアルトーン マルチ周波数

デュアルトーン マルチ周波数 (DTMF) 機能を使用すると、無線機システム内で電話機システムを操作できます。

すべての無線機トーンと警告を無効にすることで、DTMF トーンをオフにできます。詳細については、「無線機トーンアラートのオンとオフの切り替え ページ 204」を参照してください。

DTMF 通話の開始

下記の手順に従って、無線機で DTMF 通話を開始します。

- 1 **PTT** ボタンを押し続けます。
- 2 以下のいずれか 1 つの手順を実行します。
 - 番号を入力して DTMF 通話を開始します。
 -  を押して DTMF 通話を開始します。
 -  を押して DTMF 通話を開始します。

グループ コールとして電話通話への応答



下記の手順に従って、無線機でグループ コール通話に応答します。

グループ コール通話を受信した場合:

- ディスプレイの右上隅に **[電話]** アイコンが表示されます。
- ディスプレイにグループのエイリアスと **[でんわ]** が表示されます。

無線機で無線通話機能が有効になっていない場合、ディスプレイの最初の行に **[りようふか]** と表示され、無線機によって通話がミュートされます。通話が終了すると、前の画面に戻ります。

- 1 電話に応答するには、**[PTT]** ボタンを押します。相手の声を聞くには、**PTT** ボタンを放します。
- 2 通話を終了するには、 を押します。
ディスプレイに **[でんわせつだん]** と表示されます。
通話が正常に終了した場合:
 - トーンが鳴ります。

- ディスプレイに【コールしゅうりょう】と表示されます。

通話が正常に終了しなかった場合、無線機は通話画面に戻ります。この手順を繰り返してコールを終了します(または、電話のユーザーがコールを終了するまで待ちます)。

一斉コールとして電話通話への応答

一斉コール通話を受信した場合は、一斉コールタイプがチャンネルに割り当てられている場合にのみ、通話の応答や終了が可能です。下記の手順に従って、無線機で一斉コール通話に応答します。

一斉コール通話を受信した場合:

- ディスプレイの右上隅に【電話】アイコンが表示されません。
- ディスプレイに【いっせいコール】と【でんわ】が表示されます。

無線機で無線通話機能が有効になっていない場合、ディスプレイの最初の行に【りようふか】と表示され、無線機によって通話がミュートされます。

通話が終了すると、前の画面に戻ります。

1 電話に応答するには、**[PTT]** ボタンを押します。

2 相手の声を聞くには、**PTT** ボタンを放します。

3 通話を終了するには、**(📞)** を押します。

ディスプレイに【でんわせつだん】と表示されます。通話が正常に終了した場合:

- トーンが鳴ります。
- ディスプレイに【いっせいコール】と【コールしゅうりょう】が表示されます。

通話が正常に終了しなかった場合、無線機は通話画面に戻ります。**ステップ 3** を繰り返します(または電話機ユーザーが通話を終了するまで待ちます)。

個別コールとして電話通話への応答

下記の手順に従って、無線機で個別コール通話に応答します。

個別コール通話を受信した場合:

- ディスプレイの右上隅に **[電話]** アイコンが表示されます。
- ディスプレイに発信者のエイリアスまたは **【でんわ】** が表示されます。

無線機で無線通話機能が有効になっていない場合、ディスプレイの最初の行に **【りょうふか】** と表示され、無線機によって通話がミュートされます。通話が終了すると、前の画面に戻ります。

- 1 電話に応答するには、**[PTT]** ボタンを押します。相手の声を聞くには、**PTT** ボタンを放します。

- 2 通話を終了するには、**(☎)** を押します。

ディスプレイに **【でんわせつだん】** と表示されます。通話が正常に終了した場合:

- トーンが鳴ります。
- ディスプレイに **【コールしゅうりょう】** と表示されます。

通話が正常に終了しなかった場合、無線機は通話画面に戻ります。この手順を繰り返してコールを終了します(または、電話のユーザーがコールを終了するまで待ちます)。

通話の停止

この機能により、現在進行中のグループまたは個別コールを停止し、送信のためにチャンネルを解放できます。たとえば、ユーザーが不注意で **PTT** ボタンを押して "スタックマイク" の状態になった場合に、この機能を使用できます。この機能を使用するには、無線機をプログラムする必要があります。下記の手順に従って、無線機で通話を停止します。

- 1 プログラムされた **[リモート送信解除]** ボタンを押します。
ディスプレイに **【リモート ストップ】** と表示されます。

- 2 確認応答を待ちます。

正常に行われた場合:

- ポジティブ インジケータ トーンが鳴ります。
- ディスプレイに **【きょうせい ていし せいこう】** と表示されます。

正常に行われなかった場合:

- ネガティブ インジケータ トーンが鳴ります。

- ディスプレイに「きょうせい ていし しっぱい」と表示されます。

**注記:**

詳細については、ディーラーまたはシステム管理者にご確認ください。

ダイレクト モード

この機能を使用すれば、リピータが作動していない場合や、お使いの無線機がリピータの圏外にある場合でも、通話範囲内にある他の無線機との通信を継続できます。

ダイレクトモード設定は、電源を切った後も保持されます。

**注記:**



この機能は、同じ周波数の **Capacity Plus**—シングルサイト、**Capacity Plus**—マルチサイト、および **Citizens Band** チャンネルでは利用できません。



リピータとダイレクト モードの切り替え



下記の手順に従って、無線機でリピータとダイレクト モードを切り替えます。

- 1 以下のいずれか 1 つの手順を実行します。

- プログラムされた **[リピータ/ダイレクト]** ボタンを押します。以下の手順をスキップします。
-  を押してメニューにアクセスします。

- 2  または  を押して「せってい」に移動します。 を押して選択します。

- 3  または  を押して「きのうせってい」に移動します。 を押して選択します。

- 4  または  を押して「ダイレクト モード」に移動します。 を押して選択します。
有効にすると、✓が「ゆうこう」の隣に表示されます。
無効な場合、✓が「ゆうこう」の隣で非表示になります。
前の画面に自動的に戻ります。

ブロードキャスト音声通話

ブロードキャスト音声通話は、ユーザーからグループ全体に対する一方向の音声通話です。

ブロードキャスト音声通話機能では、通話を開始したユーザーのみがグループへ送信でき、通話の受信者は応答できません(コールハングタイムなし)。

この機能を使用するには、無線機をプログラムする必要があります。詳細については、ディーラーまたはシステム管理者にご確認ください。

ブロードキャスト音声通話の発信

ブロードキャスト音声通話を行うように無線機をプログラムします。

- 1 アクティブなグループのエイリアスまたは ID のチャンネルを選択します。

- 2 **PTT** ボタンを押して通話を発信します。

緑色の LED が点灯します。ディスプレイに【ブロードキャスト コール】、【グループ コール】アイコンとエイリアスが表示されます。

- 3 以下のいずれか 1 つの手順を実行します。

- 通話許可トーンが完了するまで待機し、マイクに向かってはっきりと話します(有効な場合)。
- **PTT** サイドトーンが完了するまで待機し、マイクに向かってはっきりと話してください(有効な場合)。



注記:

チャンネルのユーザーは、ブロードキャスト音声通話には応答できません。

通話が終了すると、前のメニューに戻ります。

プログラム可能な数値キーを使用したブロードキャスト音声通話の発信

下記の手順に従って、プログラム可能な数値キーを使用して無線機でブロードキャスト音声通話を発信します。

- 1 **[ホーム]** 画面で、事前に定義されたエイリアスまたは ID に割り当てられたプログラム済みの数値キーを長押しします。

数値キーが特定のモードのエントリに割り当てられている場合、別のモードで数値キーを長く押ししても、この機能は使用できません。





数値キーがエントリに割り当てられていない場合、ネガティブインジケータトーンが鳴ります。



- 2 **PTT** ボタンを押して通話を発信します。
緑色の **LED** が点灯します。

詳細については、「[プログラム可能な数値キーへのエントリの割り当て ページ 415](#)」を参照してください。





エイリアス検索を使用したブロードキャスト音声通話の発信

下記の手順に従って、エイリアス検索を使用して無線機でブロードキャスト音声通話を発信します。

- 1  を押してメニューにアクセスします。
- 2  または  を押して [れんらくさき] に移動します。  を押して選択します。
ディスプレイにアルファベット順でエントリが表示されます。

- 3  または  を押して必要な無線機のエイリアスまたは **ID** に移動します。ディスプレイの 1 行目に [ばんごう:] と表示されます。ディスプレイの 2 行目に、点滅するカーソルが表示されます。キーパッドを使用して、電話番号を入力します。

- 4  を押して選択します。選択したエントリが空の場合、ネガティブインジケータトーンが鳴り、ディスプレイに [つうわむこうなばんごう] と表示されます。

- 5  または  を押して [通話] に移動し、  を押して選択します。アクセスコードが連絡先リストで事前に設定されていない場合、ディスプレイの 1 行目に [アクセス コード:] と表示されます。ディスプレイの 2 行目に、点滅するカーソルが表示されます。アクセスコードを入力し、  ボタンを押して先に進みます。成功すると、DTMF トーンが鳴ります。電話機ユーザーのダイアルトーンが聞こえます。ディスプレイの 1 行目に、無線機のエイリアスまたは **ID** と [RSSI] アイコンが表示されます。ディスプレイの 2 行目に [でんわつうわ] および [電話通話] アイコンが表示されます。失敗の場合、トーンが鳴り、ディスプレイに [でんわ NG] と

表示されます。アクセスコード入力画面に戻ります。アクセスコードが[れんらくさき]リストで事前に設定されている場合、そのコールを開始する前の画面に戻ります。

6 話すときには **PTT** ボタンを押し、聞くときにはボタンを放します。送信中は **[RSSI]** アイコンが消えます。

7 電話通話中に追加の数字を入力する必要がある場合は、次のいずれか 1 つの手順を実行します。



- キーボードのいずれかのキーを押し、追加の数字の入力を始めます。ディスプレイの 1 行目に【つかケタ:】と表示されます。ディスプレイの 2 行目に、点滅するカーソルが表示されます。残りの数字を入力し、**[OK]** を押して、先に進みます。DTMF トーンが鳴り、前の画面に戻ります。
- **ワンタッチ アクセス** ボタンを押します。DTMF トーンが鳴ります。**ワンタッチ アクセス** ボタンのエントリが空の場合、ネガティブ インジケータ トーンが鳴ります。

8 通話を終了するには、**[⏏]** を押します。ディアアクセスコードが連絡先リストで事前に設定されていない

場合、ディスプレイの 1 行目に【ディアアクセスコード:】と表示されます。ディスプレイの 2 行目に、点滅するカーソルが表示されます。ディアアクセス

コードを入力し、**[OK]** を押して先に進みます。前の画面に戻ります。DTMF トーンが鳴り、ディスプレイに【でんわせつだん】と表示されます。成功の場合、トーンが鳴り、ディスプレイに【でんわしゅうりょう】と表示されます。電話通話画面に戻ります。失敗した場合、無線機は電話通話画面に戻ります。電話連絡先画面で **PTT** ボタンを押すと、トーンが鳴り、ディスプレイに【コール >OK】と表示されます。電話機ユーザーが通話を終了するとトーンが鳴り、ディスプレイに【でんわしゅうりょう】と表示されます。電話通話でリクエストされた追加の数字を入力している間に通話が終了した場合、その通話を開始する前の画面に戻ります。

**注記:**

チャンネルアクセス中に  を押して、コール試行とトーン音ボタンを解除するか、エイリアス検索を終了します。エイリアス検索を終了するには、

ボタンまたは  を押します。コール中、ディアクセスコードが事前設定されている状態でワンタッチアクセスボタンを押すか、追加の数字の入力としてディアクセスコードを入力すると、コールの終了が試行されます。チャンネルアクセスおよびアクセス/ディアクセスコードまたは追加の数字の送信中は、無線機は、オン/オフボタン、音量コントロールノブ、およびチャンネルロッカーにのみ反応します。無効な入力を行うたびにトーンが鳴ります。

- テキスト行の 2 行目に、[ブロードキャスト コール] と表示されます。
- 無線機のミュートが解除され、着信通話の音はスピーカから聞こえます。

通話が正常すると、無線機は前の画面に戻ります。

ブロードキャスト音声通話の場合、事前に定めた終了前の待機時間は適用されません。

ブロードキャスト音声通話には応答できません。

**注記:**

通話を受信中に別のチャンネルに切り替える場合、無線機はブロードキャスト音声通話の受信を停止します。ブロードキャスト音声通話が終了するまで、メニューナビゲーションや編集を続行することはできません。

ブロードキャスト音声通話の受信

ブロードキャスト音声通話を受信した場合:

- トーンが鳴ります。
- 緑色の LED が点滅します。
- ディスプレイの右上隅に [グループ コール] アイコンが表示されます。
- テキスト行の 1 行目に発信者のエイリアス ID が表示されます。

未アドレス通話

未アドレス通話とは、事前に定義された 16 のグループ ID のいずれかに対するグループ通話です。

この機能は CPS-RM を使用して設定されます。未アドレス通話を開始または受信するには、事前定義された ID のいずれかの連絡先が必要です。詳細については、ディーラーまたはシステム管理者にご確認ください。

未アドレス通話の発信

1 アクティブなグループのエイリアスまたは ID のチャンネルを選択します。

2 **PTT** ボタンを押して通話を発信します。

緑色の LED が点灯します。テキスト行に【未アドレス通話】、【グループ通話】アイコンおよびエイリアスが表示されます。

3 以下のいずれか 1 つの手順を実行します。

- 通話許可トーンが完了するまで待機し、マイクに向かってはっきりと話します (有効な場合)。
 - **PTT** サイドトーンが完了するまで待機し、マイクに向かってはっきりと話してください (有効な場合)。
-

4 相手の声を聞くには、**PTT** ボタンを放します。

相手先の無線機が応答すると、LED が緑色に点灯します。瞬間トーンが鳴ります。ディスプレイに【未アドレス通話】、【グループ通話】アイコン、エイリアスまたは ID と、送信側無線機のエイリアスまたは ID が表示されます。

5 チャンネルフリー指示機能が有効な場合、送信無線機で **[PTT]** ボタンが放された瞬間に、短い警告トーンが鳴ります。これは、そのチャンネルが応答できるようになったことを示します。電話に応答するには、**[PTT]** ボタンを押します。

音声アクティビティがないまま、事前に定められた時間が経過すると、通話が終了します。

通話の発信者は  を押して、グループ コールを終了できます。

未アドレス通話への応答

宛先なしコールを受信した場合:

- 緑色の LED が点滅します。
- 瞬間トーンが鳴ります。
- テキスト行に、【未アドレス通話】、発信者のエイリアス、およびグループ通話のエイリアスが表示されます。
- 無線機のミュートが解除され、着信通話の音はスピーカから聞こえます。

1 以下のいずれか 1 つの手順を実行します。

- チャンネルフリー指示機能が有効な場合、送信無線機で **[PTT]** ボタンが離された瞬間に、短い警告

トーンが鳴ります。これは、そのチャンネルが応答できるようになったことを示します。電話に応答するには、**[PTT]** ボタンを押します。

- 音声割り込み機能が有効になっている場合、**[PTT]** ボタンを押して送信側無線機から音声に割り込んで、応答できるようにそのチャンネルを解放します。

緑色の LED が点灯します。

2 以下のいずれか 1 つの手順を実行します。

- 通話許可トーンが完了するまで待機し、マイクに向かってはっきりと話します (有効な場合)。
- **PTT** サイドトーンが完了するまで待機し、マイクに向かってはっきりと話してください (有効な場合)。

3 相手の声を聞くには、**PTT** ボタンを放します。

音声アクティビティがないまま、事前に定められた時間が経過すると、通話が終了します。

オープン音声チャンネル モード (OVCM)

オープン音声チャンネル モード (OVCM) を使用すると、特定のシステムで動作するように事前に設定されていない無線

機で、グループ通話または個別通話中に受信と送信の両方を行うことができます。

OVCM グループ通話はブロードキャスト コールにも対応しています。この機能を使用するように無線機をプログラムします。詳細については、ディーラーまたはシステム管理者にご確認ください。

OVCM コールの発信

OVCM コールを発信するには無線機をプログラムする必要があります。下記の手順に従って、無線機で **OVCM** コールを発信します。

1 **PTT** ボタンを押して通話を発信します。

緑色の LED が点灯します。

テキスト行に、通話タイプのアイコン、**OVCM** およびエイリアスが表示されます。無線機が **OVCM** 状態に入ったことを示します。

2 以下のいずれか 1 つの手順を実行します。

- 通話許可トーンが完了するまで待機し、マイクに向かってはっきりと話します (有効な場合)。

- **PTT** サイドトーンが完了するまで待機し、マイクに向かってはっきりと話してください (有効な場合)。
-

OVCM コールへの応答

OVCM コールを受信した場合:

- 緑色の LED が点滅します。
- テキスト行には、通話タイプのアイコン、OVCM、エイリアスが表示されます。
- 無線機のミュートが解除され、着信通話の音はスピーカから聞こえます。

1 以下のいずれか 1 つの手順を実行します。

- チャンネルフリー指示機能が有効な場合、送信無線機で **[PTT]** ボタンが離された瞬間に、短い警告トーンが鳴ります。これは、そのチャンネルが応答できるようになったことを示します。電話に応答するには、**[PTT]** ボタンを押します。
- 音声割り込み機能が有効になっている場合、**[PTT]** ボタンを押して送信側無線機から音声に割り込んで、応答できるようにそのチャンネルを解放します。

緑色の LED が点灯します。

2 以下のいずれか 1 つの手順を実行します。

- 通話許可トーンが完了するまで待機し、マイクに向かってはっきりと話します (有効な場合)。
 - **PTT** サイドトーンが完了するまで待機し、マイクに向かってはっきりと話してください (有効な場合)。
-

3 相手の声を聞くには、**PTT** ボタンを放します。

音声アクティビティがないまま、事前に定められた時間が経過すると、通話が終了します。

高度な機能

この章では、無線機で使用できる機能の操作について説明します。

ディーラーやシステム管理者が、特定のニーズのために無線機をカスタマイズしている可能性もあります。詳細については、ディーラーまたはシステム管理者にご確認ください。

ホームチャンネルリマインダ

これは、無線機が一定期間ホームチャンネルにセットされていない場合に通知を出す機能です。

CPS を使用してこの機能を有効にしている場合は、無線機がホームチャンネルに設定されていないと、以下の動作が定期的に繰り返されます。

- ホームチャンネルリマインダトーンが鳴り、音声ガイドが聞こえます。
- ディスプレイの1行目に【ノン】と表示されます。
- 2行目に【ホームチャンネル】と表示されます。

次のいずれかの操作を実行して、この通知に応答できます。

- ホームチャンネルに戻る。
- プログラム可能ボタンを使用して、通知を一時的にミュートする。
- プログラム可能ボタンを使用して、新しいホームチャンネルを設定する。

ホームチャンネルリマインダのミュート

ホームチャンネルリマインダが鳴った場合に、リマインダを一時的にミュートできます。

ホームチャンネルリマインダのミュートプログラム可能ボタンを押します。



ディスプレイの1行目に【HCR】、2行目に【サイレンス】が表示されます。



新しいホームチャンネルの設定



ホームチャンネルリマインダが通知された場合は、新しいホームチャンネルをセットできます。



1 以下のいずれか1つの手順を実行します。

- **ホームチャンネルのリセット** プログラム可能ボタンを押して、現在のチャンネルをホームチャンネルとしてセットします。以下の手順をスキップします。
ディスプレイの1行目にチャンネルエイリアス、2行目に【しん ホーム Ch】が表示されます。
-  を押してメニューにアクセスします。

2  または  を押して【せってい】に移動します。
 を押して選択します。

3  または  を押して『きのうせってい』に移動します。  を押して選択します。

4  または  を押して『ホーム チャンネル』に移動します。  を押して選択します。

5  または  を押して、目的の新しいホームチャンネルのエリアスに移動します。  を押して選択します。

ディスプレイには、選択したチャンネル エリアスの横に  が表示されます。



無線機チェック

この機能を使用すると、システム内の他の無線機がアクティブであるかどうかを、無線機のユーザーを呼び出さずに判断できます。ターゲットの無線機には、音声や映像による通知は行われません。この機能は、無線機のエリアスまたは ID にのみ適用されます。この機能を使用するには、無線機をプログラムする必要があります。

無線機チェックの送信

下記の手順に従って、無線機で無線機チェックを送信します。

1 プログラムされた **【無線機チェック】** ボタンを押します。

2  または  を押して必要なエリアスまたは ID に移動します。  を押して選択します。
ディスプレイに経過に関するミニ通知が表示され、要求が処理中であることが示されます。緑色の LED が点灯します。

確認応答を待ちます。

無線機が承認待ちのときに  を押すと、トーンが鳴り、無線機はすべての試行を強制終了し、無線機チェック モードを終了します。

正常に行われた場合:











- ポジティブ インジケータ トーンが鳴ります。
- ディスプレイにポジティブ ミニ通知が表示されます。

正常に行われなかった場合:



- ネガティブ インジケータ トーンが鳴ります。
- ディスプレイにネガティブ ミニ通知が表示されます。無線機のエイリアスまたは ID の画面に戻ります。



ダイアルを使用した無線機チェックの送信

下記の手順に従って、ダイアルを使用して、無線機で無線機チェックを送信します。

- 1  を押してメニューにアクセスします。
- 2  または  を押して【れんらくさき】に移動します。  を押して選択します。
- 3  または  を押して【ダイアル】に移動します。  を押して選択します。
- 4  または  を押して【むせんきばんごう】に移動します。  を押して選択します。

5 以下のいずれか 1 つの手順を実行します。

- 無線機のエイリアスまたは ID を入力し、  を押して処理を続行します。
- 以前にダイアルした ID を編集し、  を押して処理を続行します。

6  または  を押して【むせんチェック】に移動します。  を押して選択します。

ディスプレイに経過に関するミニ通知が表示され、要求が処理中であることが示されます。緑色の LED が点灯します。

7 確認応答を待ちます。

無線機が承認待ちのときに  を押すと、トーンが鳴り、無線機はすべての試行を強制終了し、無線機チェック モードを終了します。

正常に行われた場合:

- ポジティブ インジケータ トーンが鳴ります。
- ディスプレイにポジティブ ミニ通知が表示されます。

正常に行われなかった場合:

- ネガティブ インジケータ トーンが鳴ります。
- ディスプレイにネガティブ ミニ通知が表示されます。

無線機のエイリアスまたは ID の画面に戻ります。

リモート モニタ

この機能を使用して、無線機のエイリアスまたは ID でターゲットの無線機のマイクをオンにします。この機能を使用することで、ターゲット無線機の周りのあらゆる音声アクティビティをリモートでモニタできます。

リモート モニタには 2 種類あります。

- 認証を使用しないリモート モニタ
- 認証を使用するリモート モニタ

認証を伴うリモート モニタは、購入可能な機能です。認証を伴うリモート モニタでは、無線機でターゲットの無線機のマイクをオンにする際に検証が必要です。

無線機で、ユーザー認証を使用してターゲットの無線機に対してこの機能を開始する場合、パズフレーズが必要です。パズフレーズは、CPS を使用して、ターゲットの無線機に事前にプログラムしておきます。



この機能を使用するには、お使いの無線機とターゲット無線機の両方をプログラムする必要があります。

この機能は、プログラムされた期間の経過後、または相手の無線機でユーザーが何らかの操作を実行したときに、停止します。

リモート モニタの開始

下記の手順に従って、無線機でリモート モニタを開始します。

- 1 プログラムされた **[リモート モニタ]** ボタンを押します。

- 2  または  を押して必要なエイリアスまたは ID に移動します。

- 3  を押して選択します。下記のいずれかの状態になります。

- ディスプレイに経過に関するミニ通知が表示され、要求が処理中であることが示されます。緑色の LED が点灯します。
- パズフレーズ画面が表示されます。

パスフレーズを入力します。  を押して次の操作へ進みます。

- パスフレーズが正しい場合、ディスプレイに経過に関するミニ通知が表示され、要求が処理中であることが示されます。緑色のLEDが点灯します。
- パスフレーズが正しくない場合、ディスプレイにネガティブミニ通知が表示され、前の画面に戻ります。

4 確認応答を待ちます。

正常に行われた場合:

- ポジティブインジケータトーンが鳴ります。
- ディスプレイにポジティブミニ通知が表示されます。
- プログラムされた長さの間、モニタ対象の無線機から音声の再生が開始され、ディスプレイに【きょうせいモニタ】と表示されます。タイマーの期限が切れると、警告トーンが鳴り、LEDが消灯します。

正常に行われなかった場合:



- ネガティブインジケータトーンが鳴ります。



- ディスプレイにネガティブミニ通知が表示されます。



連絡先リストを使用したりリモートモニタの開始

下記の手順に従って、連絡先リストを使用して無線機でリモートモニタを開始します。

- 1  を押してメニューにアクセスします。

- 2  または  を押して【れんらくさき】に移動します。  を押して選択します。

- 3  または  を押して必要なエイリアスまたはIDに移動します。  を押して選択します。

- 4  または  を押して【リモートモニタ】に移動します。
-

5  を押して選択します。下記のいずれかの状態になります。

- ディスプレイに経過に関するミニ通知が表示され、要求が処理中であることが示されます。緑色のLEDが点灯します。
- パスフレーズ画面が表示されます。

パスフレーズを入力します。  を押して次の操作へ進みます。

- パスフレーズが正しい場合、ディスプレイに経過に関するミニ通知が表示され、要求が処理中であることが示されます。緑色のLEDが点灯します。
- パスフレーズが正しくない場合、ディスプレイにネガティブミニ通知が表示され、前の画面に戻ります。

6 確認応答を待ちます。

正常に行われた場合:

- ポジティブインジケータトーンが鳴ります。
- ディスプレイにポジティブミニ通知が表示されます。

- プログラムされた長さの間、モニタ対象の無線機から音声の再生が開始され、ディスプレイに【きょうせいモニタ】と表示されます。タイマーの期限が切れると、警告トーンが鳴り、LEDが消灯します。



正常に行われなかった場合:



- ネガティブインジケータトーンが鳴ります。
- ディスプレイにネガティブミニ通知が表示されます。



ダイヤルを使用したりリモートモニタの開始

下記の手順に従って、ダイヤルを使用して無線機でリモートモニタを開始します。



1  を押してメニューにアクセスします。



2  または  を押して【れんらくさき】に移動します。  を押して選択します。

3  または  を押して【ダイヤル】に移動します。  を押して選択します。

4  または  を押して【むせんきばんごう】に移動します。  を押して選択します。

5 以下のいずれか 1 つの手順を実行します。

- 無線機のエアリアスまたは ID を入力し、  を押して処理を続行します。
 - 以前にダイヤルした ID を編集し、  を押して処理を続行します。
-

6  または  を押して【リモート モニタ】に移動します。

7  を押して選択します。下記のいずれかの状態になります。

- ディスプレイに経過に関するミニ通知が表示され、要求が処理中であることが示されます。緑色の LED が点灯します。

- パズフレーズ画面が表示されます。

パズフレーズを入力します。  を押して次の操作へ進みます。

- パズフレーズが正しい場合、ディスプレイに経過に関するミニ通知が表示され、要求が処理中であることが示されます。緑色の LED が点灯します。
 - パズフレーズが正しくない場合、ディスプレイにネガティブミニ通知が表示され、前の画面に戻ります。
-

8 確認応答を待ちます。

正常に行われた場合:

- ポジティブインジケータトーンが鳴ります。
- ディスプレイにポジティブミニ通知が表示されます。
- プログラムされた長さの間、モニタ対象の無線機から音声の再生が開始され、ディスプレイに【きようせいモニタ】と表示されます。タイマーの期限が切れると、警告トーンが鳴り、LED が消灯します。

正常に行われなかった場合:

- ネガティブ インジケータ トーンが鳴ります。
- ディスプレイにネガティブ ミニ通知が表示されます。

スキャン リスト

スキャン リストは、個別チャンネルまたはグループに対して作成され、割り当てられます。無線機は、現在のチャンネルまたはグループのスキャン リストで指定されたチャンネルまたはグループ系列を循環して、音声アクティビティをスキャンします。

無線機では、最大 **250** のスキャン リストを使用できます。リスト内の最大メンバー数は **16** です。

各スキャン リストには、アナログとデジタルの両方のエントリーを混在させることができます。

スキャン リストを編集して、チャンネルの追加や削除、優先順位付けが可能です。

正面パネル プログラミングから、新しいスキャン リストを無線機に追加できます。詳細については、「[正面パネル設定 ページ 192](#)」を参照してください。

メンバーに優先度が設定されている場合は、メンバーのエイリアスの左側に **[優先度]** アイコンが表示され、優先度 **1** と優先度 **2** のどちらのチャンネル リストに属しているかが示

されます。スキャン リストに複数の優先度 **1** または優先度 **2** チャンネルを含めることはできません。優先度を **[なし]** に設定すると、**[優先度]** アイコンは表示されません。











注記:

この機能は、**Capacity Plus** では利用できません。







スキャン リスト内のエントリーの表示

下記の手順に従って、無線機でスキャン リストのエントリーを表示します。

- 1  を押してメニューにアクセスします。
- 2  または  を押して **[スキャン]** に移動します。  を押して選択します。
- 3  または  を押して **[スキャン リスト]** に移動します。  を押して選択します。
- 4  または  を使用して、リストにある各メンバーを表示します。

エイリアス検索を使用したスキャン リスト内のエントリの表示

下記の手順に従って、エイリアス検索を使用して無線機でスキャン リストのエントリを表示します。











- 1  を押してメニューにアクセスします。
- 2  または  を押して【スキャン】に移動します。 を押して選択します。
- 3  または  を押して【スキャン リスト】に移動します。 を押して選択します。
- 4 必要なエイリアスの最初の文字を入力します。
ディスプレイに表示されているカーソルが点滅します。
- 5 必要なエイリアスの残りの文字を入力します。
エイリアス検索では、大文字と小文字が区別されます。同じ名前のエントリが2つ以上ある場合、リス



トの最初に記載されたエントリがディスプレイに表示されます。



テキスト行の1行目に入力した文字が表示されます。テキスト行の次の行に検索結果の短い一覧が表示されます。

スキャン リストへの新規エントリの追加







下記の手順に従って、無線機でスキャン リストに新規エントリを追加します。

- 1  を押してメニューにアクセスします。
- 2  または  を押して【スキャン】に移動します。 を押して選択します。
- 3  または  を押して【スキャン リスト】に移動します。 を押して選択します。
- 4  または  を押して【メンバーつか】に移動します。 を押して選択します。

5  または  を押して必要なエイリアスまたは ID に移動します。  を押して選択します。











6  または  を押して必要な優先度に移動します。  を押して選択します。
ディスプレイにポジティブ ミニ通知が表示されてから、【つかか?】と表示されます。

7 以下のいずれか 1 つの手順を実行します。

- 別のエントリを追加するには、  または  を押して【はい】に移動します。  を押して選択します。 [ステップ 5](#) と [ステップ 6](#) を繰り返します。
 - 現在のリストを保存するには、  または  を押して【いいえ】に移動します。  を押して選択します。
-

エイリアス検索を使用したスキャン リストへの新規エントリの追加

下記の手順に従って、エイリアス検索を使用して無線機でスキャン リストに新規エントリを追加します。

- 1  を押してメニューにアクセスします。
 - 2  または  を押して【スキャン】に移動します。  を押して選択します。
 - 3  または  を押して【スキャン リスト】に移動します。  を押して選択します。
 - 4  または  を押して【メンバーつかか】に移動します。  を押して選択します。
 - 5 必要なエイリアスの最初の文字を入力します。
ディスプレイに表示されているカーソルが点滅します。
-

6 必要なエイリアスの残りの文字を入力します。

エイリアス検索では、大文字と小文字が区別されます。同じ名前のエントリが2つ以上ある場合、リストの最初に記載されたエントリがディスプレイに表示されます。



テキスト行の1行目に入力した文字が表示されます。テキスト行の次の行に検索結果の短い一覧が表示されます。



7 を押して選択します。

8 または を押して必要な優先度に移動します。 を押して選択します。

ディスプレイにポジティブミニ通知が表示されてから、【つか?】と表示されます。

9 以下のいずれか1つの手順を実行します。

- 別のエントリを追加するには、 または  を押して【はい】に移動します。  を押して選択します。手順 [ステップ 5](#) から手順 [ステップ 8](#) を繰り返します。

- 現在のリストを保存するには、 または  を押して【いいえ】に移動します。  を押して選択します。
-

スキャン リストからのエントリの削除



下記の手順に従って、スキャン リストからエントリを削除します。

1 を押してメニューにアクセスします。

2 または を押して【スキャン】に移動します。 を押して選択します。



3 または を押して【スキャン リスト】に移動します。 を押して選択します。

4 または を押して必要なエイリアスまたは ID に移動します。 を押して選択します。



5  または  を押して【さくじょ】に移動します。 を押して選択します。

ディスプレイに【エントリをさくじょ?】と表示されます。

6 以下のいずれか 1 つの手順を実行します。

- エントリを削除するには、 または  を押して【はい】に移動します。 を押して選択します。

ディスプレイにポジティブ ミニ通知が表示されます。

- 前の画面に戻るには、 または  を押して【いいえ】に移動します。 を押して選択します。



7 **ステップ 4** から **ステップ 6** を繰り返して、他のエントリを削除します。



8 すべての必要なエイリアスまたは ID を削除したら、 を長押ししてホーム画面に戻ります。



スキャン リストのエントリに対して優先度を設定する



下記の手順に従って、無線機でスキャン リストのエントリに優先度を設定します。



1  を押してメニューにアクセスします。

2  または  を押して【スキャン】に移動します。 を押して選択します。

3  または  を押して【スキャン リスト】に移動します。 を押して選択します。

4  または  を押して必要なエイリアスまたは ID に移動します。 を押して選択します。

5  または  を押して【ゆうせんど】に移動します。 を押して選択します。

- 6  または  を押して必要な優先度に移動します。  を押して選択します。

ディスプレイにポジティブミニ通知が表示された後、前の画面に戻ります。**[優先度]** アイコンは、メニューのエイリアスの左側に表示されます。

スキャン

スキャンを開始すると、無線機は現在のチャンネルのプログラムスキャンリストを循環して、音声アクティビティを検索します。



注記:

この機能は、**Capacity Plus** では利用できません。

デジタルチャンネルをお使いの場合、デュアルモードスキャン中は、無線機はアナログチャンネルにロックされます。通話中は、デジタルモードからアナログモードに自動的に切り替わります。逆もまた同じです。

スキャンを開始するには 2 通りの方法があります。

メインチャンネルスキャン (マニュアル)

無線機は、スキャンリストにあるすべてのチャンネルまたはグループをスキャンします。設定しただけ、自動的に、最後にスキャンしたアクティブなチャンネルまたはグ

ループのスキャンから開始されることも、スキャンの開始時に使用していたチャンネルからスキャンが開始されることもあります。

自動スキャン (自動)

自動スキャンが有効になっているチャンネルまたはグループを選択すると、無線機が自動的にスキャンを開始します。



注記:

スキャンでグループメッセージを受信する を設定すると、無線機はホーム以外のチャンネルからグループメッセージを受信できるようになります。無線機は、ホームチャンネルのグループメッセージには返信できますが、ホーム以外のチャンネルでは返信できません。詳細については、ディーラーまたはシステム管理者にご確認ください。



スキャンのオンとオフの切り替え



下記の手順に従って、無線機でスキャンのオンとオフを切り替えます。



1



 を押してメニューにアクセスします。

2  または  を押して【スキャン】に移動します。  を押して選択します。

3  または  を押して【スキャンちゅう】に移動します。  を押して選択します。

4  または  を押して必要なスキャン状態に移動し、  を押して選択します。

スキャンが有効になっている場合:

- ディスプレイに【スキャン オン】と【スキャン】アイコンが表示されます。
- 黄色の LED が点滅します。

スキャンが無効になっている場合:

- ディスプレイに【スキャン オフ】と表示されます。
- 【スキャン】アイコンが消えます。
- LED がオフになります。

スキャン中の送信への応答

スキャン中、無線機はアクティビティが検知されたチャネルまたはグループで停止します。無線機は、ハングタイムと呼ばれるプログラムされた時間だけそのチャネルに留まります。下記の手順に従って、スキャン中に送信に応答します。

- 1  チャネルフリー指示機能が有効な場合、送信無線機で **PTT** ボタンが離された瞬間に、短い警告トーンが鳴ります。これは、そのチャネルが応答できるようになったことを示します。ハングタイム中に **PTT** ボタンを押します。

緑色の LED が点灯します。

- 2 相手の声を聞くには、**PTT** ボタンを放します。

ハングタイム中に応答しないと、無線機は他のチャネルまたはグループのスキャンに戻ります。

迷惑チャネルの削除

チャネルで不要な通話やノイズ ("迷惑" チャネルと称する) が発生し続ける場合、その不要なチャネルをスキャンリストから一時的に削除できます。この機能は、選択チャネル

として指定されているチャンネルには適用されません。下記の手順に従って、無線機で迷惑チャンネルを削除します。

- 1 無線機が不要なチャンネル、つまり迷惑チャンネルにロックされているときに、プログラムされた **【迷惑チャンネル削除】** ボタンをトーンが鳴るまで押します。
- 2 プログラムされた **【迷惑チャンネル削除】** ボタンを放します。
迷惑チャンネルが削除されます。

迷惑チャンネルの復元

下記の手順に従って、無線機で迷惑チャンネルを復元します。

以下のいずれか 1 つの手順を実行します。

- 無線機の電源を切り、もう一度電源を入れます。
- プログラムされた **【スキャン】** ボタンまたはメニューを使用してスキャンを停止し、再開します。
- **チャンネルアップ/チャンネルダウン** ボタンを使用してチャンネルを変更します。

投票スキャン

投票スキャン機能は、複数の基地局がさまざまなアナログチャンネルで同じ情報を送信している領域を幅広くカバーするための機能です。

無線機は、複数の基地局のアナログチャンネルをスキャンし、投票プロセスを実行して最大強度の受信信号を選択します。これがいったん確立されると、その基地局からの送信を受信します。

投票スキャンの実行時に、黄色の LED が点滅し、**【投票スキャン】** アイコンが表示されます。

投票スキャンの実行時に送信に応答するには、[スキャン中の送信への応答 ページ 411](#) と同じ手順に従ってください。

連絡先設定

連絡先は、無線機でアドレス帳として機能します。各エントリは、通話を開始するときに使用するエイリアスまたは ID に対応します。エントリはアルファベット順にソートされます。

各エントリは、コンテキストに応じて、次のような別々の通話タイプに関連づけられています。グループコール、個別コール、一斉コール、PC コール、ディスプレイコール。

PC コールとディスパッチ コールはデータ関連です。これらはアプリケーションで使用する場合にのみ利用できます。詳細については、データ アプリケーションのマニュアルを参照してください。

● その他、[れんらくさき] メニューでは、各エントリを 1 つのプログラミング可能な数値キーに、複数のエントリをキーパッドマイクに割り当てることができます。1 つのエントリが 1 つの数値キーに割り当てられている場合は、そのエントリに対してクイックダイヤルを実行できます。



注記:

各エントリに割り当てられる数値キーの前にチェックマークが表示されます。チェックマークが【なし】の前にある場合、その数値キーはエントリに割り当てられていません。

連絡先の各エントリには、以下の情報が表示されます。

- [通話タイプ]
- 通話エイリアス
- [通話 ID]







注記:



あるチャンネルで秘話モード機能が有効であれば、そのチャンネルで、秘話モード対応のグループコール、個別コール、および一斉コールを発信することができます。お使いの無線機と同一のプライバシーキー、または同じキー値とキー ID を有する相手先無線機のみが、送信を復号できます。

連絡先リストを使用したグループコールの発信

下記の手順に従って、連絡先リストを使用して無線機でグループコールを発信します。

- 1  を押してメニューにアクセスします。

- 2  または  を押して [れんらくさき] に移動します。  を押して選択します。

- 3  または  を押して必要なエイリアスまたは ID に移動します。  を押して選択します。

- 4 **PTT** ボタンを押して通話を発信します。
緑色の **LED** が点灯します。



- 5 相手の声を聞くには、**PTT** ボタンを放します。
グループ内のユーザーが応答すると、**LED** が緑色に点滅します。ディスプレイに **[グループコール]** アイコン、エイリアスまたは **ID** と、送信側無線機のエイリアスまたは **ID** が表示されます。



- 6  チャネルフリー指示機能が有効な場合、送信無線機で **[PTT]** ボタンが離された瞬間に、短い警告トーンが鳴ります。これは、そのチャネルが応答できるようになったことを示します。電話に応答するには、**[PTT]** ボタンを押します。
音声アクティビティがないまま、事前に定められた時間が経過すると、通話が終了します。

連絡先リストを使用した個別コールの発信

下記の手順に従って、連絡先リストを使用して無線機で個別コールを発信します。

- 1  を押してメニューにアクセスします。

- 2  または  を押して **[れんらくさき]** に移動します。  を押して選択します。

- 3  または  を押して必要なエイリアスまたは **ID** に移動します。  を押して選択します。

- 4 **PTT** ボタンを押して通話を発信します。
緑色の **LED** が点灯します。宛先のエイリアスが表示されます。

- 5 通話許可トーンが完了するまで待機し、マイクに向かってはっきりと話します (有効な場合)。

- 6 相手の声を聞くには、**PTT** ボタンを放します。
相手先の無線機が応答すると、**LED** が緑色に点滅します。ディスプレイに送信ユーザーのエイリアスまたは **ID** が表示されます。

- 7  チャネルフリー指示機能が有効な場合、送信無線機で **[PTT]** ボタンが離された瞬間に、短い警告トーン



ンが鳴ります。これは、そのチャンネルが応答できるようになったことを示します。電話に応答するには、**[PTT]** ボタンを押します。



音声アクティビティがないまま、事前に定められた時間が経過すると、通話が終了します。トーンが鳴ります。ディスプレイに「コールしゅうりょう」と表示されます。



プログラム可能な数値キーへのエントリの割り当て



下記の手順に従って、無線機でプログラム可能な数値キーにエントリを割り当てます。



- 1  を押してメニューにアクセスします。

- 2  または  を押して「れんらくさき」に移動します。  を押して選択します。

- 3  または  を押して必要なエイリアスまたは ID に移動します。  を押して選択します。

- 4  または  を押して「キー プログラム」に移動します。  を押して選択します。

- 5 以下のいずれか 1 つの手順を実行します。
 - 目的の数値キーがエントリに割り当てられていない場合、  または  を押して目的の数値キーに移動します。  を押して選択します。
 - 目的の数値キーがエントリに割り当てられている場合、ディスプレイに「しようちゅうキー」と表示され、テキスト行の 1 行目に「うわがき?」と表示されます。以下のいずれか 1 つの手順を実行します。

 または  を押して「はい」に移動します。  を押して選択します。

無線機からはポジティブ インジケータ トーンが聞こえ、ディスプレイに「れんらくさきはぞんずみ」およびポジティブ ミニ通知が表示されます。

前の手順に戻るには、  または  を押して「いいえ」に移動します。

各エントリは、さまざまな数値キーに割り当てられます。エントリに割り当てられる各数値キーの前に✓が表示されます。✓が【なし】の前にある場合、その数値キーは割り当てられていません。



数値キーが特定のモードのエントリに割り当てられている場合、別のモードで数値キーを長く押しても、この機能は使用できません。



前のメニューに自動的に戻ります。



エントリとプログラミング可能な数値キー間の関連付けの削除



下記の手順に従って、無線機でエントリとプログラミング可能な数値キー間の関連付けを削除します。

- 1 以下のいずれか 1 つの手順を実行します。
 - プログラムされた数値キーを長押しして必要なエイリアスまたは ID に移動します。ステップ 4 に進みます。
 -  を押してメニューにアクセスします。



2  または  を押して【れんらくさき】に移動します。  を押して選択します。

3  または  を押して必要なエイリアスまたは ID に移動します。  を押して選択します。

4  または  を押して【キー プログラム】に移動します。  を押して選択します。

5  または  を押して【なし】に移動します。  を押して選択します。

テキスト行の 1 行目に、【ぜんキーからさくじよしますか】と表示されます。

6  または  を押して【はい】に移動します。  を押して選択します。

**注記:**

エントリが削除されたら、エントリとそのプログラミングされた数値キー間の関連付けは、削除されます。

ポジティブ インジケータ トーンが鳴ります。ディスプレイに【れんらくさきほぞんずみ】と表示されます。前のメニューに自動的に戻ります。

新規連絡先の追加

下記の手順に従って、無線機で新規連絡先を追加します。

- 1 を押してメニューにアクセスします。

- 2 または を押して【れんらくさき】に移動します。 を押して選択します。

- 3 または を押して【しんき とうろく】に移動します。 を押して選択します。

- 4 または を押して、連絡先タイプを【むせ ん リスト】または【電話 リスト】から選択します。 を押して選択します。

- 5 キーパッドを使用して連絡先番号を入力し、 を押して先に進みます。



- 6 キーパッドを使用して連絡先名を入力し、 を押して先に進みます。



- 7 または を押して必要な着信音タイプに移動します。 を押して選択します。
 ポジティブ インジケータ トーンが鳴ります。ディスプレイにポジティブ ミニ通知が表示されます。



既定の連絡先の設定

下記の手順に従って、無線機で既定の連絡先を設定します。

- 1 を押してメニューにアクセスします。

2  または  を押して【れんらくさき】に移動します。  を押して選択します。

3  または  を押して必要なエリアまたは ID に移動します。  を押して選択します。

4  または  を押して【しよきちにセット】に移動します。  を押して選択します。

ポジティブ インジケータ トーンが鳴ります。ディスプレイにポジティブ ミニ通知が表示されます。ディスプレイでは、選択した既定のエリアまたは ID の横に  が表示されます。



通話インジケータ設定



この機能を使用すると、無線機ユーザーが通話やテキストメッセージの着信音を設定できます。



着信音のオンとオフの切り替え (ページング用)



下記の手順に従って、無線機でページング受信時の着信音のオンとオフを切り替えます。



1  を押してメニューにアクセスします。



2  または  を押して【せってい】に移動します。  を押して選択します。

3  または  を押して【きのうせってい】に移動します。  を押して選択します。

4  または  を押して【トーン/アラート】に移動します。  を押して選択します。

5  または  を押して【ちやくしんおん】に移動します。  を押して選択します。



6  または  を押して【ページング】に移動します。  を押して選択します。



7  または  を押して必要なトーンに移動します。  を押して選択します。ディスプレイに、✓と選択したトーンが表示されます。



着信音のオンとオフの切り替え (個別コール用)



下記の手順に従って、無線機で個別コール受信時の着信音のオンとオフを切り替えます。



1  を押してメニューにアクセスします。

2  または  を押して【せってい】に移動します。  を押して選択します。

3  または  を押して【きのうせってい】に移動します。  を押して選択します。



4  または  を押して【トーン/アラート】に移動します。  を押して選択します。

5  または  を押して【ちやくしんおん】に移動します。  を押して選択します。

6  または  を押して【こべつコール】に移動します。  を押して選択します。

個別コールの着信音がオンの場合は、【オン】の隣に✓が表示されます。







個別コールの着信音がオフの場合は、【オフ】の隣に✓が表示されます。



- 7  または  を押して必要なトーンに移動します。  を押して選択します。



有効にすると、✓が【ゆうこう】の隣に表示されます。無効な場合、✓が【ゆうこう】の隣で非表示になります。



着信音のオンとオフの切り替え (選択コール用)



下記の手順に従って、無線機で選択コール受信時の着信音のオン/オフを切り替えます。

- 1  を押してメニューにアクセスします。
- 2  または  を押して【せってい】に移動します。  を押して選択します。
- 3  または  を押して【きのうせってい】に移動します。  を押して選択します。

- 4  または  を押して【トーン/アラート】に移動します。  を押して選択します。

- 5  または  を押して【ちやくしんおん】に移動します。  を押して選択します。



- 6  または  を押して【せんたくコール】に移動します。  を押して選択します。
ディスプレイに ✓ と現在のトーンが表示されます。



- 7  または  を押して必要なトーンに移動します。  を押して選択します。ディスプレイに、✓と選択したトーンが表示されます。



着信音のオンとオフの切り替え (テキストメッセージ用)



下記の手順に従って、無線機でテキストメッセージ受信時の着信音のオン/オフを切り替えます。





- 1  を押してメニューにアクセスします。





- 2  または  を押して『せってい』に移動します。 を押して選択します。

- 3  または  を押して『きのうせってい』に移動します。 を押して選択します。

- 4  または  を押して『トーン/アラート』に移動します。 を押して選択します。

- 5  または  を押して『ちゃくしんおん』に移動します。 を押して選択します。



- 6  または  を押して『テキストメッセージ』に移動します。 を押して選択します。
ディスプレイに  と現在のトーンが表示されます。



- 7  または  を押して必要なトーンに移動します。 を押して選択します。
ディスプレイに、 と新たに選択したトーンが表示されます。



着信音のオンとオフの切り替え (テキスト付きテレメータステータス用)



下記の手順に従って、無線機でテレメータステータス用着信音のオン/オフを切り替えます。





- 1  を押してメニューにアクセスします。

- 2  または  を押して『せってい』に移動します。 を押して選択します。

3  または  を押して【きのうせってい】に移動します。  を押して選択します。

4  または  を押して【トーン/アラート】に移動します。  を押して選択します。

5  または  を押して【ちやくしんおん】に移動します。  を押して選択します。



6  または  を押して【テレメトリ】に移動します。  を押して選択します。
現在のトーンは、 で示されます。



着信音スタイルの割り当て



特定の連絡先から個別通話、ページング、またはテキストメッセージを受信したときに、事前定義された 11 個の着信音のいずれか 1 つが鳴るように、無線機をプログラムできます。リストを操作すると、各着信音スタイルが鳴ります。



下記の手順に従って、無線機の着信音スタイルを割り当てます。





1  を押してメニューにアクセスします。

2  または  を押して【れんらくさき】に移動します。  を押して選択します。
エントリはアルファベット順にソートされます。

3  または  を押して必要なエイリアスまたは ID に移動します。  を押して選択します。

4  または  を押して【ひょうじ/へんしゅう】に移動します。  を押して選択します。









5 【ちやくしんおん】メニューが表示されるまで、 を押します。
現在のトーンは  で示されます。

- 6  または  を押して必要なトーンに移動します。  を押して選択します。
- 選択した設定の隣りに  **A** が表示されます。

- すべての通話の削除
- 詳細の表示

最近の通話の表示

下記の手順に従って、無線機で最近の通話を表示します。

- 1  を押してメニューにアクセスします。
- 2  または  を押して【つうわりれき】に移動します。  を押して選択します。
- 3  または  を押して優先リストに移動します。オプションは【ふざいちゃくしん】、【へんとうずみ】、および【はっしん】リストです。
 を押して選択します。
ディスプレイに最近のエントリが表示されます。
- 4  または  を押してリストを表示します。

警告トーンの音量を上げる

無線機は、無線機通話に応答がない状態が続くと継続的に警告を発するようにプログラムできます。時間が経つにつれて、アラームトーンは自動的に大きくなります。この機能はステップアラートとして知られています。

通話履歴機能

無線機は、最近の発信、応答、不在の個別コールをすべて記録します。最近の通話の表示および管理を行うには、通話履歴機能を使用します。







お使いの無線機のシステム設定に応じて、不在着信アラートを通話履歴に含めることができます。各通話リストでは次のタスクを実行できます。











- 連絡先へのエイリアスまたは ID の保存
- 通話の削除

PTT ボタンを押すと、現在ディスプレイに表示されているエイリアスまたは ID で、通話を開始できます。

通話リストからの通話の削除

下記の手順に従って、通話リストから通話を削除します。



- 1  を押してメニューにアクセスします。
 - 2  または  を押して [つうわ りれき] に移動します。  を押して選択します。
 - 3  または  を押して必要なリストに移動します。  を押して選択します。
リストが空の場合:
 - トーンが鳴ります。
 - ディスプレイに [リストがありません] と表示されます。
-



- 4  または  を押して必要なエイリアスまたは ID に移動します。  を押して選択します。
 - 5  または  を押して [Delete Entry?] (エントリをさくじょ?) に移動します。  を押して選択します。
 - 6 以下のいずれか 1 つの手順を実行します。
 -  を押して [はい] を選択してエントリを削除します。
ディスプレイに [にゅうりよくさくじょずみ] と表示されます。
 -  または  を押して [いいえ] に移動します。  を押して選択します。
前の画面に戻ります。
-



通話リストの詳細の表示



下記の手順に従って、無線機で通話の詳細を表示します。

- 1  を押してメニューにアクセスします。

- 2  または  を押して【つうわ りれき】に移動します。  を押して選択します。

- 3  または  を押して必要なリストに移動します。  を押して選択します。



- 4  または  を押して必要なエイリアスまたは ID に移動します。  を押して選択します。



- 5  または  を押して【しょうさい】に移動します。  を押して選択します。
ディスプレイに通話の詳細が表示されます。



通話リストからのエイリアスまたは ID の保存



下記の手順に従って、通話リストから無線機にエイリアスまたは ID を保存します。

- 1  を押してメニューにアクセスします。

- 2  または  を押して【つうわ りれき】に移動します。  を押して選択します。

- 3  または  を押して必要なリストに移動します。  を押して選択します。

- 4  または  を押して必要なエイリアスまたは ID に移動します。  を押して選択します。

- 5  または  を押して『ほかん』に移動します。  を押して選択します。
- ディスプレイに表示されているカーソルが点滅します。

-
- 6 必要なエイリアスの残りの文字を入力します。
-  を押して選択します。
- エイリアスなしで ID を格納することができます。
- ディスプレイにポジティブ ミニ通知が表示されま

ページング操作

ページング機能を使用して、特定の無線機ユーザーに、かけ直すようアラートを送信できます。

この機能は、無線機のエイリアスまたは ID のみに適用され、メニューから [れんらくさき] または [ダイアル] を選択するか、プログラムされた [ワンタッチ アクセス] ボタンを使用してアクセスできます。

ページングの発信

下記の手順に従って、無線機でページングを発信します。

- 1 プログラムされた [ワンタッチ アクセス] ボタンを押します。

ディスプレイに『ページング』と無線機のエイリアスと ID が表示されます。緑色の LED が点灯します。











- 2 確認応答を待ちます。

ページング承認を受信した場合は、ディスプレイにポジティブ ミニ通知が表示されます。

ページング承認を受信していない場合は、ディスプレイにネガティブ ミニ通知が表示されます。

連絡先リストを使用したページングの発信







下記の手順に従って、連絡先リストを使用して無線機でページングを発信します。

- 1  を押してメニューにアクセスします。
- 2  または  を押して【れんらくさき】に移動します。  を押して選択します。
- 3  または  を押して必要なエリアまたは ID に移動します。  を押して選択します。
- 4  または  を押して【ページング】に移動します。  を押して選択します。
ディスプレイに【ページング】と無線機のエリアまたは ID が表示されます。緑色の LED が点灯します。



- 5 確認応答を待ちます。
 - ページング承認を受信した場合は、ディスプレイにポジティブ ミニ通知が表示されます。
 - ページング承認を受信していない場合は、ディスプレイにネガティブ ミニ通知が表示されます。

ダイヤルを使用したページングの発信

手下記の手順に従って、ダイヤルを使用して無線機でページングを発信します。

- 1  を押してメニューにアクセスします。
- 2  または  を押して【れんらくさき】に移動します。  を押して選択します。
- 3  または  を押して【ダイヤル】に移動します。  を押して選択します。
ディスプレイに表示されているカーソルが点滅しなくなります。

4 無線機の ID を入力し、 を押して先に進みます。

5  または  を押して [ページング] に移動します。 を押して選択します。

ディスプレイに [ページング] と無線機のエイリアスまたは ID が表示されます。緑色の LED が点灯します。

6 確認応答を待ちます。

- ページング承認を受信した場合は、ディスプレイにポジティブ ミニ通知が表示されます。
- ページング承認を受信していない場合は、ディスプレイにネガティブ ミニ通知が表示されます。

- ディスプレイに通知リストが表示され、ページングとともに、呼び出し元無線機のエイリアスまたは ID が示されます。

ディーラーまたはシステム管理者の設置に応じて、以下の 1 つを行うことによりページングに応答できます。

- **PTT** ボタンを押し、個別コールを使って発信者に直接応答します。
- **PTT** ボタンを押し、通常のグループ通信を続けます。
ページングは通話履歴メニューの不在着信履歴オプションに移動します。不在着信履歴から発信者に応答できます。

詳しくは、「[通知リスト ページ 190](#)」および「[通話履歴機能 ページ 126](#)」を参照してください。

ページングへの応答

下記の手順に従って、無線機でページングに応答します。

ページングを受信した場合:

- 反復トーンが鳴ります。
- 黄色の LED が点滅します。

ミュート モード

ミュート モードでは、無線機のすべての音声インジケータを無音にすることができます。

ミュート モード機能を開始すると、緊急操作などの優先度の高い機能を除くすべての音声インジケータがミュートされます。

ミュート モードを終了すると、無線機で、継続中のトーンおよび音声の再生が再開されます。

**注記:**

これは購入可能な機能です。詳細については、ディーラーまたはシステム管理者にご確認ください。

ミュート モードの有効化

下記の手順に従って、ミュート モードを有効にします。

この機能には、プログラムされた【ミュート モード】ボタンからアクセスします。











ミュート モードを有効にすると、次のことが発生します。



- ポジティブインジケータ トーンが鳴ります。
- ディスプレイに【ミュート モード オン】と表示されます。
- 赤色の LED ライトの点滅が開始し、ミュート モードが終了するまで点滅したままになります。
- ディスプレイのホーム画面に【ミュート モード】アイコンが表示されます。
- 無線機がミュートになります。
- ミュート モード タイマーが、設定された時間のカウントダウンを開始します。

ミュート モード タイマーの設定

ミュート モード タイマーを設定すると、事前設定した所定の時間の間、ミュート モード機能を有効にすることができます。タイマーの時間は、無線機メニューで 0.5 ~ 6 時間の範囲内に設定できます。ミュート モードは、タイマーの時間が切れると終了します。

タイマーを 0 のままにすると、プログラムされた【ミュート モード】ボタンを押すまで、無線機は無期限にミュート モードになります。

- 1  を押してメニューにアクセスします。
- 2  または  を押して【せってい】に移動します。  を押して選択します。
- 3  または  を押して【きのうせってい】に移動します。  を押して選択します。
- 4  または  を押して【ミュート タイマー】に移動します。  を押して選択します。

- 5  または  を押して各桁の数値を編集し、
 を押します。

ミュート モードの終了

この機能は、ミュート モード タイマーの時間が切れると、自動的に終了します。

ミュート モードを手動で終了するには、次のいずれかの操作を実行します。

- プログラムされた **[ミュート モード]** ボタンを押します。
- 任意のエントリで **PTT** ボタンを押します。

ミュート モードを無効にすると、次のことが発生します。

- ネガティブ インジケータ トーンが鳴ります。
- ディスプレイに **[ミュート モード オフ]** と表示されます。
- 点滅する赤い LED が消灯します。
- ホーム画面から **[ミュート モード]** アイコンが消えます。

- 無線機のミュートが解除され、スピーカーが元の状態に戻ります。
- タイマーの時間が切れていない場合、ミュート モード タイマーが停止します。



注記:

ユーザーが音声を送信した場合や、プログラムされていないチャンネルに切り替えた場合も、ミュート モードは終了します。

緊急操作

重大な状況を示すために、緊急アラームが使用されます。いつでも、現在のチャンネルでアクティビティがある場合であっても、緊急操作を開始できます。

ディーラーは、プログラムされた **[緊急]** ボタンの押し下げ時間を設定できます。ただし、他のボタンと同様、長押しは除きます。

短押し

0.05 ~ 0.75 秒の間

長押し

1.00 ~ 3.75 秒の間

緊急 ボタンには、緊急のオン/オフ機能が割り当てられています。**緊急** ボタンに割り当てられている操作については、ディーラーに確認してください。

**注記:**

緊急ボタンの短押しで緊急モードが開始される場合には、長押しで緊急モードが終了します。

緊急ボタンの長押しで緊急モードが開始される場合には、短押しで緊急モードが終了します。

お使いの無線機は、3つの緊急アラームをサポートしています。

- 緊急アラーム
- 通話による緊急アラーム
- 音声ガイドおよび緊急アラーム 

**注記:**

上記の緊急アラームのいずれか1つのみを、プログラムされた**[緊急]**ボタンまたは緊急フットスイッチに割り当てることができます。

また、各アラームには以下のタイプがあります。

レギュラー

無線機がアラーム信号を送信し、音声インジケータと視覚的インジケータのいずれかまたは両方で示されます。

サイレント

無線機がアラーム信号を送信しますが、音声インジケータも視覚的インジケータも示されません。プログラムされた**[ホットマイク]**送信時間が終了するか、**PTT**ボ

タンが押されるまで、スピーカから音が漏れることなく通話を受信します。

音声付きサイレント

音声または視覚的インジケータなしにアラーム信号を受信しますが、着信通話の音はスピーカから聞こえません。

緊急アラームの受信

下記の手順に従って、無線機で緊急アラームを受信します。



緊急アラームを受信した場合:

- トーンが鳴ります。
- 赤色のLEDが点滅します。
- ディスプレイに、**緊急**アイコン、緊急通話送信者のエイリアスが表示されます。また、複数のアラームが出ている場合は、すべての緊急通話送信者のエイリアスがアラームリストに表示されます。

1 以下のいずれか1つの手順を実行します。

- アラームが1つだけの場合、詳細を表示するには

 **OK** を押します。

- 複数のアラームが出ている場合、詳細を表示するには、 または  を押して必要なエイリアスに移動し、 を押します。

2  を押すと、操作オプションが表示されます。

3 アラーム リストを終了するには、 を押して『はい』を選択します。

4  を押してメニューにアクセスします。

5 『アラーム』を選択すると、アラーム リストが再表示されます。



6 緊急モードを終了するまでトーンが鳴り、赤色の LED が点滅します。ただし、トーンはミュートすることができます。以下のいずれか 1 つの手順を実行します。

- 緊急アラームを受信した無線機グループを呼び出すには、**PTT** ボタンを押します。
- プログラム可能ボタンを押します。

- 緊急モードを終了します。「**緊急アラーム受信後の緊急モードの終了 ページ 433**」を参照してください。

緊急アラームへの応答

下記の手順に従って、無線機で緊急アラームに応答します。

1 ディスプレイにアラーム リストが表示されていることを確認します。 または  を押して必要なエイリアスまたは ID に移動します。

2  チャネルフリー指示機能が有効な場合、送信無線機で **[PTT]** ボタンが離された瞬間に、短い警告トーンが鳴ります。これは、そのチャンネルが応答できるようになったことを示します。緊急アラームの送信先と同じグループに緊急でない音声を転送するには、**[PTT]** ボタンを押します。

緑色の LED が点灯します。無線機は緊急モードを保ちます。

3 以下のいずれか 1 つの手順を実行します。

- 通話許可トーンが完了するまで待機し、マイクに向かってはっきりと話します (有効な場合)。

-  **PTT** サイドトーンが完了するまで待機し、マイクに向かってはっきりと話してください (有効な場合)。

4 相手の声を聞くには、**PTT** ボタンを放します。

緊急操作を開始した無線機が応答する場合:

- 緑色の **LED** が点滅します。
- ディスプレイに、**[グループ コール]** アイコンおよび **ID**、送信中の無線機の **ID**、およびアラームリストが表示されます。

緊急音声を転送できるのは、緊急起動無線だけです。緊急受信無線を含めて、その他の無線は、緊急以外の音声を転送します。

緊急アラーム受信後の緊急モードの終了

緊急アラームの受信後に緊急モードを終了するには、次のいずれかの操作を実行します。

- アラーム項目を削除します。

- 無線機の電源を切ります。

緊急アラームの送信

この機能では、音声信号ではない緊急アラームを送信します。この機能を使用して、無線機グループにアラートを通知できます。お使いの無線機がサイレントに設定されている場合、緊急モード中にオーディオや視覚的インジケータは一切表示されません。

下記の手順に従って、無線機で緊急アラームを送信します。

1 プログラムされた **[緊急オン]** ボタンを押します。

次のいずれかが表示されます。

- ディスプレイに **[Tx アラーム]** および宛先のエイリアスが表示されます。
-  **[Tx テレグラム]** および宛先のエイリアスが表示されます。

緑色の **LED** が点灯します。 **[緊急]** アイコンが表示されます。

**注記:**

プログラムされている場合は、緊急検索トーンが鳴ります。このトーンは、無線機で音声を送受信するときにはミュートされ、緊急モードが終了すると停止されます。緊急検索トーンは **CPS** を使ってプログラムできます。

2 確認応答を待ちます。

正常に行われた場合:

- 緊急トーンが鳴ります。
- 赤色の **LED** が点滅します。
- ディスプレイに【アラームそうしん】と表示されます。

再試行がすべて失敗して処理が正常に行われなかった場合:

- トーンが鳴ります。
- ディスプレイに【アラーム NG】と表示されます。

緊急アラームモードが終了し、ホーム画面に戻ります。

通話による緊急アラームの送信

この機能では、通話による緊急アラームを無線機グループに送信します。グループ内の無線機から確認応答がある場合、無線機グループは、プログラムされた緊急チャンネルで通信できます。

下記の手順に従って、無線機で通話による緊急アラームを送信します。

- 1** プログラムされた **【緊急オン】** ボタンまたは **緊急** フットスイッチを押します。ディスプレイに、**【アラームそうしんちゅう】** が、無線機 **ID** と交互に表示されません。

次のように表示されます:

- **【Tx テレグラム】** および宛先のエイリアスが表示されます。

緑色の **LED** が点灯します。 **【緊急】** アイコンが表示されます。

**注記:**

プログラムされている場合は、緊急検索トーンが鳴ります。このトーンは、無線機で音声を送受信するときにはミュートされ、緊急モードが終了すると停止されます。緊急検索トーンは、ディーラーまたはシステム管理者がプログラムできます。

2 確認応答を待ちます。

正常に行われた場合:

- 緊急トーンが鳴ります。
- 赤色の **LED** が点滅します。
- ディスプレイに【アラームそうしん】と表示されます。
- ディスプレイに【きんきゅう】と宛先グループのエイリアスが表示されると、無線機が緊急通話モードに入ります。

3 **PTT** ボタンを押して通話を発信します。

緑色の **LED** が点灯します。ディスプレイに、【グループコール】アイコンが表示されます。

4 以下のいずれか 1 つの手順を実行します。

- 通話許可トーンが完了するまで待機し、マイクに向かってはっきりと話します (有効な場合)。
-  **PTT** サイドトーンが完了するまで待機し、マイクに向かってはっきりと話してください (有効な場合)。

5 相手の声を聞くには、**PTT** ボタンを放します。

ディスプレイに、発信者とグループのエイリアスが表示されます。

6  チャンネルフリー指示機能が有効な場合、送信無線機で **[PTT]** ボタンが離された瞬間に、短い警告トーンが鳴ります。これは、そのチャンネルが応答できるようになったことを示します。電話に応答するには、**[PTT]** ボタンを押します。**7** 通話を終えた後に緊急モードを終了するには、**緊急オフ** ボタンを押します。

無線機はホーム画面に戻ります。

音声ガイドおよび緊急アラーム

この機能では、緊急アラームと音声ガイドを無線機グループに送信します。無線機のマイクは自動的に有効になり、**PTT** ボタンを押さずに無線機グループと通信できます。このアクティブな状態のマイクを "ホット マイク" と呼びます。



注記:

無線機は、背面アクセサリ コネクタに接続されている **IMPRES** 以外のマイクを検出することができません。

指定されたプログラム済みコネクタでマイクが検出されない場合、無線機は代わりとなるコネクタを調べます。ここで、無線機は検出されたマイクを優先します。

緊急サイクル モードが有効な場合、プログラムされた期間、"ホット マイク" と受信期間が繰り返されます。緊急サイクル モードでは、受信コールの音はスピーカから聞こえます。

プログラムされた受信期間に **PTT** ボタンを押すと、通話禁止音が聞こえます。これは、**PTT** ボタンを放す必要があることを示します。**PTT** ボタンが押されたことは無視され、緊急モードが保たれます。

ホット マイクが有効なときに **[PTT]** ボタンを押し、ホット マイクの期限が切れた後もそのまま押し続けていた場合は、**[PTT]** ボタンを放すまで無線機は送信を続けます。

緊急アラームのリクエストに失敗すると、無線機はそのリクエストを再送信せず、直接 "ホット マイク" 状態に入ります。



注記:

"ホット マイク" を使用できないアクセサリもあります。詳細については、ディーラーまたはシステム管理者にご確認ください。

緊急アラームと音声ガイドの送信

下記の手順に従って、無線機で緊急アラームと音声ガイドを送信します。

- 1 プログラムされた **[緊急オン]** ボタンまたは **緊急** フットスイッチを押します。

以下のいずれかの結果が表示されます。

- **[Tx アラーム]** および宛先のエイリアスが表示されます。
- **[Tx テレグラム]** および宛先のエイリアスが表示されます。

緑色の LED が点灯します。【緊急】アイコンが表示されます。

- ディスプレイに【アラームそうしん】と表示されたら、マイクに向かってはっきりと話します。

次の場合、無線機は自動的に送信を終了します。

- 緊急サイクルモードが有効で、"ホットマイク"と通話受信のサイクルの期限が切れた場合。
- 緊急サイクルモードが無効で、"ホットマイク"の期限が切れた場合。

- 緊急オフ** ボタンを押して、緊急モードを終了します。無線機はホーム画面に戻ります。

緊急モードの再開

この機能は、緊急アラームを送信する無線機にのみ適用されます。下記の手順に従って、無線機で緊急モードを再開します。

以下のいずれか 1 つの手順を実行します。

- 無線機が緊急モードの間に、チャンネルを変更します。新しいチャンネルで緊急アラームが有効になると、無線機は緊急モードを一度終了して、改めて緊急モードを再開します。
- 緊急の起動または転送ステータス時に、プログラムされた【緊急オン】ボタンを押します。無線機は、この状態を終了し再び緊急モードになります。

緊急アラーム送信後の緊急モードの終了

この機能は、緊急アラームを送信する無線機にのみ適用されます。

次の場合に無線機の緊急モードが終了します。

- 承認を受信した場合 (緊急アラームの場合のみ)。
- アラームを送信するすべての再試行が失敗した場合。



注記:

無線機の電源を切ると、緊急モードは終了します。もう一度電源を入れたときに、無線機が自動的に緊急モードを再開することはありません。

下記の手順に従って、無線機の緊急モードを終了します。











以下のいずれか 1 つの手順を実行します。

- プログラムされた【緊急オフ】ボタンを押します。

- 緊急システムを設定していない新しいチャンネルに変更します。
ディスプレイに【へいじょう】と表示されます。

アラーム リストからのアラーム項目の削除

以下の手順に従って、アラーム リストからアラーム項目を削除して、緊急モードを終了することができます。

- 1  を押してメニューにアクセスします。
- 2  または  を押して【アラーム】に移動します。
 を押して選択します。
- 3  または  を押して、必要なアラーム項目に移動します。
 を押して選択します。
- 4  または  を押して【さくじょ】に移動します。
 を押して選択します。

テキスト メッセージング

無線機は、他の無線機やテキスト メッセージ アプリケーションからテキスト メッセージなどのデータを受信できます。

テキスト メッセージには、デジタル車載型無線機 (DMR) ショート テキスト メッセージと、テキスト メッセージの 2 種類があります。DMR ショート テキスト メッセージの最大長は **23** 文字です。テキスト メッセージの最大長は、件名を含めて **280** 文字です。件名は、電子メール アプリケーションからメッセージを受信した場合にのみ表示されません。



注記:







この最大長は、ソフトウェアとハードウェアが最新のモデルにのみ適用されます。ソフトウェアやハードウェアが古い無線機モデルでは、最大長は **140** 文字です。詳細については、ディーラーまたはシステム管理者にご確認ください。



テキスト メッセージ

テキスト メッセージは受信 BOX に保存され、新しく受信した順番にソートされます。

テキスト メッセージの表示











下記の手順に従って、無線機でテキスト メッセージを表示します。

- 1  を押してメニューにアクセスします。
- 2  または  を押して [メッセージ] に移動します。  を押して選択します。
- 3  または  を押して [じゅしん BOX] に移動します。  を押して選択します。
受信 BOX が空の場合：
 - ディスプレイに [リストがありません] と表示されます。
 - キー操作音がオンであればトーンが鳴ります。

- 4  または  を押して必要なメッセージに移動します。  を押して選択します。
メッセージが電子メールアプリケーションから送信された場合は、件名の行が表示されます。

テレメータ ステータス メッセージの表示

下記の手順に従って、受信 BOX 内のテレメータ ステータス メッセージを表示します。

- 1  を押してメニューにアクセスします。
- 2  または  を押して [メッセージ] に移動します。  を押して選択します。
- 3  または  を押して [じゅしん BOX] に移動します。  を押して選択します。
- 4  または  を押して必要なメッセージに移動します。  を押して選択します。

テレメータ ステータス メッセージに返信することはできません。

ディスプレイに【テレメータ:】と表示されます。〈ステータス メッセージ〉

-
- 5 ホーム画面に戻るには、 を長押しします。
-

テキスト メッセージへの応答

下記の手順に従って、無線機でテキスト メッセージに応答します。

テキスト メッセージを受信する場合:









- ディスプレイに通知リストが表示され、送信者のエイリアスまたは ID が示されます。
- ディスプレイに【メッセージ】アイコンが表示されます。





注記:

PTT ボタンが押されると、警告画面が終了し、送信者への個別コールまたはグループ コールが開始されます。

- 1 以下のいずれか 1 つの手順を実行します。

-  または  を押して【ひょうじ】に移動します。  を押して選択します。ディスプレイにテキスト メッセージが表示されます。メッセージが電子メール アプリケーションから送信された場合は、件名の行が表示されません。
-  または  を押して【あとでひょうじ】に移動します。  を押して選択します。テキスト メッセージを受信する前の画面に戻ります。
-  または  を押して【さくじょ】に移動します。  を押して選択します。

-
- 2 以下のいずれか 1 つの手順を実行します。



-  を押して【じゅしん BOX】に戻ります。
 -  をもう一度押して、テキスト メッセージの返信、転送、または削除を行います。
-



クイックテキストによるテキストメッセージへの応答



下記の手順に従って、無線機でクイックテキストメッセージによるテキストメッセージに応答します。

1 以下のいずれか 1 つの手順を実行します。

- プログラムされた【メッセージ】ボタンを押します。手順 [ステップ 3](#) に進みます。
-  を押してメニューにアクセスします。



2  または  を押して【メッセージ】に移動します。 を押して選択します。



3  または  を押して【じゅしん BOX】に移動します。 を押して選択します。



4  または  を押して必要なメッセージに移動します。 を押して選択します。

メッセージが電子メールアプリケーションから送信された場合は、件名の行が表示されます。

5  を押してサブメニューにアクセスします。

6  または  を押して【へんしん】に移動します。 を押して選択します。

7  または  を押して【クイックへんしん】に移動します。 を押して選択します。

8  または  を押して必要なメッセージに移動します。 を押して選択します。

ディスプレイに経過に関するミニ通知が表示され、メッセージが送信中であることが示されます。

9 確認応答を待ちます。

正常に行われた場合:

- トーンが鳴ります。
- ディスプレイにポジティブ ミニ通知が表示されます。

正常に行われなかった場合:

- トーンが鳴ります。
- ディスプレイにネガティブ ミニ通知が表示されます。
- 無線機で【さいそうしん】オプション画面が再び表示されます。

- ポジティブ インジケータ トーンが鳴ります。
- ディスプレイにポジティブ ミニ通知が表示されます。

正常に行われなかった場合:

- ネガティブ インジケータ トーンが鳴ります。
- ディスプレイにネガティブ ミニ通知が表示されます。
- 無線機で【さいそうしん】オプション画面が再び表示されます。

テキスト メッセージの再送信

下記の手順に従って、無線機でテキスト メッセージを再送信します。

【さいそうしん】オプション画面が表示されている場合:



 を押して、同じ無線機、グループのエイリアス、または ID に、同じメッセージを再送信します。



正常に行われた場合:

テキスト メッセージの転送

下記の手順に従って、無線機でテキスト メッセージを転送します。

【さいそうしん】オプション画面が表示されている場合:

- 1  または  を押して【てんそう】に移動し、
 を押して同じメッセージを別の無線機またはグループのエイリアスまたは ID に送信します。

- 2  または  を押して必要なエリアまたは ID に移動します。  を押して選択します。ディスプレイに経過に関するミニ通知が表示され、メッセージが送信中であることが示されます。
-

3 確認応答を待ちます。

正常に行われた場合:

- ポジティブ インジケータ トーンが鳴ります。
- ディスプレイにポジティブ ミニ通知が表示されます。

正常に行われなかった場合:

- ネガティブ インジケータ トーンが鳴ります。
- ディスプレイにネガティブ ミニ通知が表示されます。







注記:



ターゲット無線機のアドレスを手動で選択することもできます(「[ダイアルを使用したテキストメッセージの転送 ページ 443](#)」を参照)。

ダイアルを使用したテキストメッセージの転送

下記の手順に従って、無線機でダイアルを使用してテキストメッセージを転送します。

- 1  または  を押して【てんそう】に移動します。  を押して選択します。
-

- 2  を押して、別の無線機、グループのエリアス、または ID に同じメッセージを送信します。
-

- 3  または  を押して【ダイアル】に移動します。  を押して選択します。ディスプレイに【むせん ID:】と表示されます。
-

- 4 無線機の ID を入力し、  を押して先に進みます。ディスプレイに経過に関するミニ通知が表示され、メッセージが送信中であることが示されます。
-

5 確認応答を待ちます。

正常に行われた場合:

- トーンが鳴ります。
- ディスプレイにポジティブ ミニ通知が表示されます。

正常に行われなかった場合:

- トーンが鳴ります。
- ディスプレイにネガティブ ミニ通知が表示されます。



テキスト メッセージの編集

【へんしゅう】を選択してメッセージを編集します。







注記:

件名行が存在する場合 (電子メール アプリケーションから受信したメッセージの場合)、この行は編集できません。

- 1  または  を押して【へんしゅう】に移動します。  を押して選択します。



ディスプレイに表示されているカーソルが点滅します。





- 2 キーパッドを使用してメッセージを編集します。

-  を押して、スペース 1 つ分左側に移動します。
-  または  を押すと、スペース 1 つ分右側に移動します。
-  を押して、不要な文字を削除します。
-  を長押しすると、テキスト入力方法が変更されます。

- 3 メッセージが完成したら、  を押します。

- 4 以下のいずれか 1 つの手順を実行します。



-  または  を押して【そうしん】に移動し、  を押してメッセージを送信します。



-  または  を押して【ほぞん】に移動し、 を押してメッセージを下書きフォルダに保存します。
 -  を押してメッセージを編集します。
 -  を押してメッセージを削除するか、下書きフォルダにこのメッセージを保存します。
-

テキスト メッセージの入力

下記の手順に従って、無線機でテキスト メッセージを作成します。



- 1 以下のいずれか 1 つの手順を実行します。
 - プログラムされた【メッセージ】ボタンを押します。ステップ 3 に進みます。
 -  を押してメニューにアクセスします。
-

- 2  または  を押して【メッセージ】に移動します。 を押して選択します。
-

- 3  または  を押して【へんしゅう】に移動します。 を押して選択します。
点滅するカーソルが表示されます。
-

- 4 キーパッドを使用してメッセージを入力します。

 を押して、スペース 1 つ分左側に移動します。





 または  を押すと、スペース 1 つ分右側に移動します。

 を押して、不要な文字を削除します。

 を長押しすると、テキスト入力方法が変更されます。

- 5 メッセージが完成したら、 を押します。
以下のいずれか 1 つの手順を実行します。

-  を押してメッセージを送信します。







-  を押します。 または  を押して、メッセージの編集、削除または保存の中から選択します。 を押して選択します。
-

テキスト メッセージの送信

下記の手順に従って、無線機でテキスト メッセージを送信します。

新規作成したテキスト メッセージまたは保存されたテキスト メッセージがあると仮定します。

メッセージ受信者を選択します。以下のいずれか 1 つの手順を実行します。

-  または  を押して必要なエイリアスまたは ID に移動します。 を押して選択します。
-  または  を押して【ダイヤル】に移動します。 を押して選択します。無線機の ID を入力します。ディスプレイの 1 行目に【むせん ID:】と表示されます。ディスプレイの 2 行目に、点滅するカーソルが表示されます。無線

機のエイリアスまたは ID を入力します。 を押します。

ディスプレイに経過に関するミニ通知が表示され、メッセージが送信中であることが示されます。

正常に行われた場合:

- トーンが鳴ります。
- ディスプレイにポジティブ ミニ通知が表示されます。

正常に行われなかった場合:

- 低いトーンが鳴ります。
- ディスプレイにネガティブ ミニ通知が表示されます。
- メッセージが【送信済みアイテム】フォルダに移動します。
- メッセージに【送信失敗】アイコンが付きます。







注記:



新規作成されたテキスト メッセージの場合、無線機は【さいそうしん】オプション画面に戻ります。



受信 BOX からのテキスト メッセージの削除

下記の手順に従って、無線機で受信 BOX からテキスト メッセージを削除します。



- 1 以下のいずれか 1 つの手順を実行します。
 - プログラムされた **[メッセージ]** ボタンを押します。 **ステップ 3** に進みます。
 -  を押してメニューにアクセスします。



- 2  または  を押して **[メッセージ]** に移動します。  を押して選択します。

- 3  または  を押して **[じゅしん BOX]** に移動します。  を押して選択します。
受信 BOX が空の場合:
 - ディスプレイに **[リストがありません]** と表示されます。
 - トーンが鳴ります。

- 4  または  を押して必要なメッセージに移動します。  を押して選択します。
メッセージが電子メールアプリケーションから送信された場合は、件名の行が表示されます。







- 5  を押してサブメニューにアクセスします。



- 6  または  を押して **[さくじょ]** に移動します。  を押して選択します。



- 7  または  を押して **[はい]** に移動します。  を押して選択します。
ディスプレイにポジティブ ミニ通知が表示されません。画面は **[受信トレイ]** に戻ります。

受信 BOX からのすべてのテキスト メッセージの削除

下記の手順に従って、無線機で受信 BOX からすべてのテキスト メッセージを削除します。

- 以下のいずれか 1 つの手順を実行します。
 - プログラムされた【メッセージ】ボタンを押します。ステップ 3 に進みます。
 -  を押してメニューにアクセスします。
-  または  を押して【メッセージ】に移動します。 を押して選択します。
-  または  を押して【じゅしん BOX】に移動します。 を押して選択します。
受信 BOX が空の場合:
 - ディスプレイに【リストがありません】と表示されます。
 - トーンが鳴ります。

-  または  を押して【ぜんさくじょ】に移動します。 を押して選択します。

-  または  を押して【はい】に移動します。 を押して選択します。
ディスプレイにポジティブ ミニ通知が表示されます。

送信済みテキスト メッセージ

別の無線機に送信されたメッセージは、送信 BOX フォルダに保存されます。最近送信されたテキスト メッセージは、必ず送信 BOX フォルダの一番上に追加されます。送信済みテキスト メッセージの再送信、転送、編集、または削除を実行できます。

送信 BOX フォルダは、最大で 30 件の最近送信されたメッセージを格納できます。フォルダが一杯であるときにテキスト メッセージを送信すると、置き換えとして、フォルダの一番古いテキスト メッセージが自動的に削除されます。

メッセージ送信中にメッセージ送信画面を終了すると、ディスプレイや音声による通知を行わずに、送信 BOX フォルダ内のメッセージのステータスが更新されます。

送信 BOX フォルダ内のメッセージ ステータスが更新される前に、無線機のモードが変更されたり電源がオフになったりすると、実行中のメッセージを完了できなくなり、そのメッセージには自動的に **[送信失敗]** アイコンが表示されます。

無線機では、同時に最大で **5** 件の実行中メッセージを使用できます。この間、新しいメッセージを送信できなくなり、新しいメッセージには自動的に **[送信失敗]** アイコンが表示されます。

 ボタンを長押しすると、無線機はいつでもホーム画面に戻ります。



注記:



従来型デジタル、Capacity Plus チャンネルなど、チャンネルタイプが一致しない場合、送信済みメッセージの編集、転送、または削除のみを行えます。



送信済みテキスト メッセージの表示

下記の手順に従って、無線機で送信済みテキスト メッセージを表示します。

- 1 以下のいずれか 1 つの手順を実行します。
 - プログラムされた **[メッセージ]** ボタンを押します。 **ステップ 3** に進みます。



-  を押してメニューにアクセスします。

- 2  または  を押して **[メッセージ]** に移動します。  を押して選択します。

- 3  または  を押して **[そうしん BOX]** に移動します。  を押して選択します。

[そうしん BOX] フォルダが空の場合:

- ディスプレイに **[リストにありません]** と表示されます。
- キー操作音がオンであれば低い音でトーンが鳴ります。





- 4  または  を押して必要なメッセージに移動します。  を押して選択します。

画面の右上隅のアイコンは、メッセージのステータスを示します。「**送信 BOX アイコン**」を参照してください。

送信済みテキスト メッセージの送信

下記の手順に従って、無線機で送信済みテキスト メッセージを送信します。

送信済みメッセージを表示する場合:

- 1 メッセージの表示中に、 を押します。
- 2 送信済みテキスト メッセージの再送信または転送を行うことができます。以下のいずれか 1 つの手順を実行します。
 -  【さいそうしん】に移動します。 を押して選択します。
 -  【てんそう】に移動します。 を押して選択します。

ディスプレイに経過に関するミニ通知が表示され、メッセージが送信中であることが示されます。

- 3 確認応答を待ちます。

正常に行われた場合:

- ポジティブ インジケータ トーンが鳴ります。

- ディスプレイにポジティブ ミニ通知が表示されます。





正常に行われなかった場合:

- ネガティブ インジケータ トーンが鳴ります。
- ディスプレイにネガティブ ミニ通知が表示されます。
- 無線機に【さいそうしん】オプション画面が表示されます。詳細については、「[テキスト メッセージの再送信 ページ 152](#)」を参照してください。

送信 BOX フォルダからの送信済みテキスト メッセージの削除

下記の手順に従って、無線機で送信 BOX フォルダから送信済みテキスト メッセージを削除します。



送信済みメッセージを表示する場合:



- 1  を押します。
- 2  または  を押して【さくじょ】に移動します。 を押して選択します。



送信 BOX フォルダからのすべての送信済みテキストメッセージの削除

下記の手順に従って、無線機で送信 BOX フォルダからすべての送信済みテキストメッセージを削除します。







- 以下のいずれか 1 つの手順を実行します。
 - プログラムされた **[メッセージ]** ボタンを押します。 **ステップ 3** に進みます。
 -  を押してメニューにアクセスします。

-  または  を押して **[メッセージ]** に移動します。  を押して選択します。

-  または  を押して **[そうしん BOX]** に移動します。  を押して選択します。
[そうしん BOX] フォルダが空の場合:
 - ディスプレイに **[リストにありません]** と表示されます。
 - トーンが鳴ります。

-  または  を押して **[ぜんさくじょ]** に移動します。  を押して選択します。

- 以下のいずれか 1 つの手順を実行します。

-  または  を押して **[はい]** に移動します。  を押して選択します。
ディスプレイにポジティブミニ通知が表示されます。
-  または  を押して **[いいえ]** に移動します。  を押して選択します。
前の画面に戻ります。

保存されたテキストメッセージ

下書きフォルダにテキストメッセージを保存し、後でそのテキストメッセージを送信できます。

PTT ボタンを押すか、モードの変更により、メッセージの作成や編集集中にメッセージの作成/編集画面から抜けてしまった場合、現在のメッセージは、下書きフォルダに自動的に保存されます。

最近保存されたテキストメッセージは、常に下書きリストの一番上に追加されます。

下書きフォルダは、最大で 10 件の最近保存されたメッセージを格納します。フォルダが一杯であるときにテキストメッセージを保存すると、フォルダの一番古いテキストメッセージが削除されます。

保存されたテキストメッセージの表示

下記の手順に従って、無線機で保存されたテキストメッセージを表示します。

- 1 以下のいずれか 1 つの手順を実行します。
 - プログラムされた **[メッセージ]** ボタンを押します。 **ステップ 3** に進みます。
 - **[OK]** を押してメニューにアクセスします。

- 2 **[▲]** または **[▼]** を押して **[メッセージ]** に移動します。 **[OK]** を押して選択します。

- 3 **[▲]** または **[▼]** を押して **[したがき]** に移動します。 **[OK]** を押して選択します。

- 4 **[▲]** または **[▼]** を押して必要なメッセージに移動します。 **[OK]** を押して選択します。

保存されたテキストメッセージの編集







下記の手順に従って、無線機に保存されたテキストメッセージを編集します。

- 1 メッセージの表示中に、 **[OK]** を押します。
- 2 **[▲]** または **[▼]** を押して **[へんしゅう]** に移動します。 **[OK]** を押して選択します。点滅するカーソルが表示されます。
- 3 キーパッドを使用してメッセージを入力します。
 - ◀ を押して、スペース 1 つ分左側に移動します。
 - ▶ または **[色井]** を押すと、スペース 1 つ分右側に移動します。
 - ⓧ を押して、不要な文字を削除します。

 を長押しすると、テキスト入力方法が変更されます。

4 メッセージが完成したら、 を押します。

以下のいずれか 1 つの手順を実行します。



-  または  を押して【そうしん】に移動します。 を押してメッセージを送信します。
-  を押します。 または  を押してメッセージの保存または削除を選択します。 を押して選択します。



下書きフォルダに保存したテキスト メッセージの削除



下記の手順に従って、無線機に保存したテキスト メッセージを下書きフォルダから削除します。



- 1 以下のいずれか 1 つの手順を実行します。
 - プログラムされた【メッセージ】ボタンを押します。ステップ 3 に進みます。

-  を押してメニューにアクセスします。

2  または  を押して【メッセージ】に移動します。 を押して選択します。

3  または  を押して【したがき】に移動します。 を押して選択します。

4  または  を押して必要なメッセージに移動します。 を押して選択します。

5  または  を押して【さくじょ】に移動します。 を押してテキスト メッセージを削除します。

クイック テキスト メッセージ



無線機では、ディーラーがプログラミングするクイック テキスト メッセージを最大 50 まで使用できます。



クイック テキスト メッセージは事前定義されていますが、送信前に各メッセージを編集できます。



クイック テキスト メッセージの送信

下記の手順に従って、無線機で事前に定義したクイック テキスト メッセージを事前に定義したエリアスに送信します。

- 以下のいずれか 1 つの手順を実行します。
 - プログラムされた **【メッセージ】** ボタンを押します。 **ステップ 6** に進みます。
 - プログラムされた **【ワンタッチ アクセス】** ボタンを押します。
ディスプレイに経過に関するミニ通知が表示され、メッセージが送信中であることが示されます。
ステップ 6 に進みます。
 -  を押してメニューにアクセスします。

-  または  を押して **【メッセージ】** に移動します。  を押して選択します。

-  または  を押して **【クイック テキスト】** に移動します。  を押して選択します。

-  または  を押して必要なクイック テキスト メッセージに移動します。  を押して選択します。

- 以下の手順で受信者を選択し、メッセージを送信します。

ディスプレイに経過に関するミニ通知が表示され、メッセージが送信中であることが示されます。

- 確認応答を待ちます。

正常に行われた場合:



- ポジティブ インジケータ トーンが鳴ります。
- ディスプレイにポジティブ ミニ通知が表示されます。

正常に行われなかった場合:

- ネガティブ インジケータ トーンが鳴ります。
- ディスプレイにネガティブ ミニ通知が表示されます。

- 無線機に「さいそうしん」オプション画面が表示されます。詳細については、「[テキストメッセージの再送信 ページ 152](#)」を参照してください。

**注記:**

-  を押すと、いつでも前の画面に戻ります。
-  を長く押すとホーム画面に戻ります。無線機は、無操作タイマーの終了後に、現在の画面を終了します。

テキスト入力設定

お使いの無線機では、さまざまなテキストを設定できます。無線機でのテキストの入力に対して次を設定できます。











- 単語予測
- 単語修正
- 文章大文字修正
- マイワード



利用できるテキスト入力方法は以下のとおりです。

- 数字
- 符号
- 予測またはマルチタップ
- 言語 (プログラムする場合)



文字修正の有効化/無効化



テキスト エディタに入力した単語が組み込み辞書で認識されない場合、単語の代わりの選択肢を提供します。



-  を押してメニューにアクセスします。
-  または  を押して「せってい」に移動します。 を押して選択します。
-  または  を押して「きのうせってい」に移動します。 を押して選択します。
-  または  を押して「もじにゆうりよく」に移動します。 を押して選択します。



5  または  を押して【もじしゅうせい】に移動します。  を押して選択します。



6 以下のいずれか 1 つの手順を実行します。

-  または  を押して【もじしゅうせい】に移動します。  を押して選択します。
- を押して【もじしゅうせい】を有効にします。有効にすると、✓が【ゆうこう】の隣に表示されます。
- を押して【もじしゅうせい】を無効にします。無効な場合、✓が【ゆうこう】の隣で非表示になります。



2  または  を押して【せってい】に移動します。  を押して選択します。

3  または  を押して【きのうせってい】に移動します。  を押して選択します。

4  または  を押して【もじにゆうりよく】に移動します。  を押して選択します。

5  または  を押して【よそく】に移動します。  を押して選択します。

6 以下のいずれか 1 つの手順を実行します。

-  を押して単語予測を有効にします。有効にすると、✓が【ゆうこう】の隣に表示されます。
-  を押してマイク ダイナミックひずみコントロールを無効にします。無効な場合、✓が【ゆうこう】の隣で非表示になります。













単語予測の有効化/無効化



単語予測無線機は、頻繁に入力する語に共通する並び順を学習できます。学習内容をもとに、テキスト エディタに共通する語の並びの最初の単語を入力すると、使用する可能性のある次の語を予測します。

1  を押してメニューにアクセスします。

文章大文字修正







この機能は、新しい文を入力するごとに、最初の語の最初の文字を自動的に大文字にするときに使用します。



- 1  を押してメニューにアクセスします。
- 2  または  を押して【せってい】に移動します。  を押して選択します。
- 3  または  を押して【きのうせってい】に移動します。  を押して選択します。
- 4  または  を押して【もじにゆうりよく】に移動します。  を押して選択します。
- 5  または  を押して【おおもじ】に移動します。  を押して選択します。
- 6 以下のいずれか 1 つの手順を実行します。



-  を押して大文字を有効にします。有効になると、✓が【ゆうこう】の隣に表示されます。
-  を押して大文字を無効にします。無効な場合、✓が【ゆうこう】の隣で非表示になります。



カスタム語の表示

自分のカスタム語を無線機に組み込まれた辞書に追加できます。無線機は、その語を含むリストを管理します。

- 1  を押してメニューにアクセスします。
- 2  または  を押して【せってい】に移動します。  を押して選択します。
- 3  または  を押して【きのうせってい】に移動します。  を押して選択します。

4  または  を押して【もじにゆうりよく】に移動します。  を押して選択します。



5  または  を押して【マイ ワード】に移動します。  を押して選択します。



6  または  を押して【たんご リスト】に移動します。  を押して選択します。
ディスプレイにはカスタム語のリストが表示され
ます。



カスタム語の編集



無線機に保存したカスタム語を編集できます。



1  を押してメニューにアクセスします。



2  または  を押して【せってい】に移動し
ます。  を押して選択します。



3  または  を押して【きのうせってい】に移動します。  を押して選択します。

4  または  を押して【もじにゆうりよく】に移動します。  を押して選択します。





5  または  を押して【マイ ワード】に移動
します。  を押して選択します。

6  または  を押して【たんご リスト】に移動
します。  を押して選択します。
ディスプレイにはカスタム語のリストが表示され
ます。

7  または  を押して必要な単語に移動し
ます。  を押して選択します。

8  または  を押して [へんしゅう] に移動します。  を押して選択します。

9 キーパッドを使用して、カスタム語を編集します。

-  を押して、スペース 1 つ分左側に移動します。
-  キーを押すと、スペース 1 つ分右側に移動します。
- 不要な文字を削除するときは、 キーを押します。
-  を長押しすると、テキスト入力方法が変更されます。

10 カスタム語が完成したら、 を押します。



ディスプレイには経過に関するミニ通知が表示され、カスタム語が保存中であることが示されます。



- カスタム語が保存されると、トーンが鳴り、ディスプレイにはポジティブミニ通知が表示されます。
- カスタム語を保存していない場合、低いトーンが鳴り、ディスプレイにネガティブミニ通知が表示されます。



カスタム語の追加



無線機の組み込み辞書に、カスタム語を追加できます。



1  を押してメニューにアクセスします。

2  または  を押して [せってい] に移動します。  を押して選択します。





3  または  を押して [きのうせってい] に移動します。  を押して選択します。

4  または  を押して [もじにゆうりよく] に移動します。  を押して選択します。

5  または  を押して [マイ ワード] に移動します。  を押して選択します。

- 6  または  を押して [しんき つか] に移動します。  を押して選択します。
- ディスプレイにはカスタム語のリストが表示されます。

7 キーパッドを使用して、カスタム語を編集します。

-  を押して、スペース 1 つ分左側に移動します。
-  キーを押すと、スペース 1 つ分右側に移動します。
- 不要な文字を削除するときは、 キーを押します。
-  を長押しすると、テキスト入力方法が変更されます。

8 カスタム語が完成したら、 を押します。













ディスプレイには経過に関するミニ通知が表示され、カスタム語が保存中であることが示されます。



- カスタム語が保存されると、トーンが鳴り、ディスプレイにポジティブミニ通知が表示されます。



- カスタム語を保存していない場合、低いトーンが鳴り、ディスプレイにネガティブミニ通知が表示されます。

カスタム語の削除





下記の手順に従って、無線機に保存したカスタム語を削除します。

- 1  を押してメニューにアクセスします。
- 2  または  を押して [せってい] に移動します。  を押して選択します。
- 3  または  を押して [きのうせってい] に移動します。  を押して選択します。
- 4  または  を押して [もじにゆうりよく] に移動します。  を押して選択します。
- 5  または  を押して [マイ ワード] に移動します。  を押して選択します。

6  または  を押して必要な単語に移動します。  を押して選択します。

7  または  を押して【さくじょ】に移動します。  を押して選択します。



8 次のいずれかを選択します。



- 【エントリをさくじょ?】で  を押して【はい】を選択します。ディスプレイに【にゆうりよくさくじょずみ】と表示されます。
 -  または  を押して【いいえ】に移動します。  を押して前の画面に戻ります。
-



すべてのカスタム語の削除



下記の手順に従って、無線機に組み込まれた辞書からすべてのカスタム語を削除します。



1  を押してメニューにアクセスします。

2  または  を押して【せってい】に移動します。  を押して選択します。

3  または  を押して【きのうせってい】に移動します。  を押して選択します。



4  または  を押して【もじにゆうりよく】に移動します。  を押して選択します。

5  または  を押して【マイ ワード】に移動します。  を押して選択します。

6  または  を押して【ぜんさくじょ】に移動します。  を押して選択します。

7 以下のいずれか 1 つの手順を実行します。

- 【エントリをさくじょ?】で  を押して【はい】を選択します。ディスプレイに【にゆうりよくさくじょずみ】と表示されます。

- 前の画面に戻るには、 または  を押し、て [いいえ] に移動します。 を押して選択します。

JOB チケット

この機能を使用して、実行するタスクを列挙するディスプレイからのメッセージを、無線機で受信できます。



注記:

この機能は、ユーザーの要件に応じて CPS 経由でカスタマイズできます。詳細については、ディーラーまたはシステム管理者にご確認ください。

次の 2 つのフォルダに、異なる種類の JOB チケットが含まれます。

[マイ タスク] フォルダ

ユーザーがサインインに使用したユーザー ID に割り当てられた、個人用の JOB チケット

[共有タスク] フォルダ

ユーザーのグループに割り当てられた共有 JOB チケット

JOB チケットに応答して、チケットを JOB チケット フォルダに並べることができます。既定のフォルダ名は **[All]**、**[New]**、**[Started]**、および **[Completed]** です。追加の 10 個

のフォルダについては、ディーラーかシステム管理者までお問い合わせください。



注記:

JOB チケットは、無線機の電源を入れ直しても保持されます。

[All] フォルダには、すべての JOB チケットが配置されます。お使いの無線機のプログラムに応じて、JOB チケットは、優先度順、次に受信時刻順にソートされます。新規の JOB チケット、状態が最近変化した JOB チケット、および優先度が最高の JOB チケットが、リストの先頭に列挙されます。JOB チケットの最大件数に達すると、最後のチケットが次のチケットに取って代わられます。無線機のモデルに応じて、最大 100 件または 500 件の JOB チケットがサポートされます。詳細については、ディーラーまたはシステム管理者にご確認ください。無線機は、JOB チケット ID が重複している JOB チケットを、自動的に検出して破棄します。

JOB チケットの重要度に応じて、ディスプレイで優先度レベルが追加されます。優先度レベルには、3 段階(優先度 1、優先度 2、優先度 3) あります。優先度 1 が最高の優先度で、優先度 3 が最低の優先度です。その他に、優先度なしの JOB チケットもあります。



ディスプレイが下記の変更を行うと、それによって無線機が更新されます。



- JOB チケットの内容修正。
- JOB チケットの優先度レベルの追加または編集。
- JOB チケットのフォルダからフォルダへの移動。
- JOB チケットのキャンセル。



JOB チケット フォルダへのアクセス

下記の手順に従って、JOB チケット フォルダへアクセスします。

- 1 以下のいずれか 1 つの手順を実行します。
 - プログラムされた **[JOB チケット]** ボタンを押します。ステップ 3 に進みます。
 -  を押してメニューにアクセスします。

- 2  または  を押して [ワーク チケット] に移動します。  を押して選択します。



- 3  または  を押して必要なフォルダに移動します。  を押して選択します。

- 4  または  を押して必要な JOB チケットに移動します。  を押して選択します。

リモート サーバーのログインとログアウト

ユーザー ID を使用して、リモート サーバーへのログインとログアウトが可能です。

- 1  を押してメニューにアクセスします。

- 2  または  を押して [ログイン] に移動します。  を押して選択します。

ログイン済みの場合は、メニューに [ログアウト] と表示されます。

ディスプレイに経過に関するミニ通知が表示され、要求が処理中であることが示されます。

- 3 確認応答を待ちます。
正常に行われた場合:

- ポジティブ インジケータ トーンが鳴ります。
- ディスプレイにポジティブ ミニ通知が表示されます。





正常に行われなかった場合:



- ネガティブ インジケータ トーンが鳴ります。
- ディスプレイにネガティブ ミニ通知が表示されます。

JOB チケットの作成

無線機は JOB チケットを作成できます。これは、JOB チケット テンプレートをベースにしたもので、実行が必要な作業を送信します。











JOB チケット テンプレートを構成するには、CPS プログラミングソフトウェアが必要です。

- 1  を押してメニューにアクセスします。
- 2  または  を押して [JOB チケット] に移動します。  を押して選択します。

- 3  または  を押して [チケットさくせい] に移動します。  を押して選択します。



JOB チケットへの応答

下記の手順に従って、無線機で JOB チケットに応答します。

- 1  を押してメニューにアクセスします。
- 2  または  を押して [JOB チケット] に移動します。  を押して選択します。
- 3  または  を押して必要なフォルダに移動します。  を押して選択します。
- 4  または  を押して必要な JOB チケットに移動します。  を押して選択します。

5 サブメニューにアクセスするには、 を再度押します。

対応する数値キー (1 ~ 9) を押して、**[クイックへんしん]** を行います。

6  または  を押して必要な JOB チケットに移動します。 を押して選択します。

ディスプレイに経過に関するミニ通知が表示され、要求が処理中であることが示されます。

7 確認応答を待ちます。

正常に行われた場合:

- ポジティブ インジケータ トーンが鳴ります。
- ディスプレイにポジティブ ミニ通知が表示されます。



正常に行われなかった場合:



- ネガティブ インジケータ トーンが鳴ります。
 - ディスプレイにネガティブ ミニ通知が表示されます。
-



単数の JOB チケット テンプレートを使った JOB チケットの送信

単数の JOB チケット テンプレートを使って無線機が構成されている場合、JOB チケットを送信するには、次の操作を実行します。

1 キーパッドを使用して、必要な部屋番号を入力します。 を押して選択します。

2  または  を押して **[へやのステータス]** に移動します。 を押して選択します。

3  または  を押して必要なオプションに移動します。 を押して選択します。

4  または  を押して **[そうしん]** に移動します。 を押して選択します。

ディスプレイに経過に関するミニ通知が表示され、要求が処理中であることが示されます。

5 確認応答を待ちます。

正常に行われた場合:



- ポジティブ インジケータ トーンが鳴ります。
- ディスプレイにポジティブ ミニ通知が表示されます。



正常に行われなかった場合:

- ネガティブ インジケータ トーンが鳴ります。
- ディスプレイにネガティブ ミニ通知が表示されます。

複数の JOB チケット テンプレートを使った JOB チケットの送信

複数の JOB チケット テンプレートを使って無線機が構成されている場合、JOB チケットを送信するには、次の操作を実行します。

- 1  または  を押して必要なオプションに移動します。  を押して選択します。

- 2  または  を押して『そうしん』に移動します。  を押して選択します。

ディスプレイに経過に関するミニ通知が表示され、要求が処理中であることが示されます。

3 確認応答を待ちます。

正常に行われた場合:

- ポジティブ インジケータ トーンが鳴ります。
- ディスプレイにポジティブ ミニ通知が表示されます。



正常に行われなかった場合:



- ネガティブ インジケータ トーンが鳴ります。
- ディスプレイにネガティブ ミニ通知が表示されます。



JOB チケットの削除



下記の手順に従って、無線機で JOB チケットを削除します。

- 1 以下のいずれか 1 つの手順を実行します。
 - プログラムされた [JOB チケット] ボタンを押します。ステップ 4 に進みます。
 -  を押してメニューにアクセスします。



- 2  または  を押して [JOB チケット] に移動します。  を押して選択します。

- 3  または  を押して必要なフォルダに移動します。  を押して選択します。

- 4  または  を押して [すべて] フォルダに移動します。  を押して選択します。

- 5  または  を押して必要な JOB チケットに移動します。  を押して選択します。

- 6 JOB チケットの表示中に、  を再度押します。

- 7  または  を押して [さくじょ] に移動します。  を押して選択します。

ディスプレイに経過に関するミニ通知が表示され、要求が処理中であることが示されます。

- 8 確認応答を待ちます。

正常に行われた場合:











- ポジティブ インジケータ トーンが鳴ります。
- ディスプレイにポジティブ ミニ通知が表示されます。



正常に行われなかった場合:







- ネガティブ インジケータ トーンが鳴ります。
- ディスプレイにネガティブ ミニ通知が表示されます。

すべての JOB チケットの削除

下記の手順に従って、無線機のすべての JOB チケットを削除します。

- 以下のいずれか 1 つの手順を実行します。
 - プログラムされた **[JOB チケット]** ボタンを押します。ステップ 3 に進みます。
 -  を押してメニューにアクセスします。
-  または  を押して **[JOB チケット]** に移動します。  を押して選択します。
-  または  を押して必要なフォルダに移動します。  を押して選択します。
-  または  を押して **[すべて]** フォルダに移動します。  を押して選択します。

-  または  を押して **[ぜんさくじょ]** に移動します。  を押して選択します。

- 以下のいずれか 1 つの手順を実行します。
 -  または  を押して **[はい]** に移動します。  を押して選択します。ディスプレイにポジティブミニ通知が表示されます。
 -  または  を押して **[いいえ]** に移動します。  を押して選択します。前の画面に戻ります。

プライバシー

この機能は、ソフトウェアベースのスクランブルソリューションの使用により、不正なユーザーによる盗聴を防ぐのに役立ちます。送信のシグナリングおよびユーザー識別の部分はスクランブルされません。

秘話モード対応で送信するには、無線機のチャンネルに秘話モードを設定する必要があります。ただし、秘話モードを設定していなくても受信はできます。秘話モード対応チャ

ネル上で、無線機はクリアな送信、つまりスクランブルされていない送信を引き続き受信できます。

無線機のモデルによっては、秘話モード機能がない場合や、構成が異なる場合があります。詳細については、ディーラーまたはシステム管理者にご確認ください。

お使いの無線機は、2種類の秘話モードをサポートしていますが、1つのモードのみを無線機に割り当てることができます。コマンドの種類は、次のとおりです。

- 基本プライバシー
- 拡張プライバシー

秘話対応通話またはデータ送信のスクランブルを解除するには、送信側無線機と同じ基本秘話モードのプライバシーキーを持つように、または、同じスクランブルモードのキー値とキーIDを持つように、お使いの無線機をプログラムする必要があります。

無線機が、異なるプライバシーキー、または異なるキー値とキーIDのスクランブル通話を受信した場合、基本秘話モードでは、音声理解できないノイズになり、スクランブル秘話モードでは、何も聞こえなくなります。

無線機のプログラム方法に応じて、秘話モード対応チャンネル上で、無線機はクリアな通話、つまりスクランブルされていない通話を受信できます。さらに、無線機のプログラム方法に応じて、警告音を鳴らすことも鳴らさないこともできます。

無線機が送信しているとは、緑色のLEDが点灯します。無線機が進行中の秘話対応通話を受信しているときは、LEDが素早く点滅します。



注記:



この機能は、同じ周波数の市民バンドチャンネルでは利用できません。



秘話モードのオンとオフの切り替え ●



下記の手順に従って、無線機で秘話モードのオンとオフを切り替えます。

- 1 以下のいずれか1つの手順を実行します。
 - プログラムされた【ひわモード】ボタンを押します。以下の手順をスキップします。









-  を押してメニューにアクセスします。

- 2  または  を押して【せってい】に移動します。 を押して選択します。

- 3  または  を押して【きのうせってい】に移動します。 を押して選択します。

4  または  を押して【ひわモード】に移動します。  を押して選択します。

5 以下のいずれか 1 つの手順を実行します。

-  または  を押して【オン】に移動します。  を押して選択します。ディスプレイで  が【オン】の隣に表示されます。
-  または  を押して【オフ】に移動します。  を押して選択します。ディスプレイで  が【オフ】の隣に表示されます。

応答禁止

この機能を使用すると、無線機が着信通話に応答しないようにすることができます。



注記:

これは購入可能な機能です。無線機がどのようにプログラムされているかについては、ディーラーまたはシステム管理者に確認してください。

有効にすると、無線機は着信通話に応答して送信通話を生成しません (無線機チェック、ページング、無線停止、リ

モート モニタ、自動登録サービス (ARS)、プライベート メッセージへの応答、および GNSS 位置報告の送信など)。この機能が有効になっていると、無線機は個別コールの確認を受信できません。ただし、無線機で手動による送信を行うことはできます。

応答禁止の有効化または無効化

無線機の応答禁止を有効または無効にするには、次の手順に従います。

プログラムされた【おうとうきんし】ボタンを押します。

正常に行われた場合:

- ポジティブ インジケータ トーンが鳴ります。
- ディスプレイにポジティブ ミニ通知が 1 回だけ表示されます。

正常に行われなかった場合:

- ネガティブ インジケータ トーンが鳴ります。
- ディスプレイにネガティブ ミニ通知が 1 回だけ表示されます。

マルチサイト コントロール

現在の無線機チャネルが **IP Site Connect** または **Capacity Plus**—マルチサイト設定に含まれている場合に適用されます。

手動サイト検索の開始

受信した信号強度が弱い場合、より信号状態の良いサイトを探すために、下記の手順に従って手動サイト検索を開始します。

無線機が新しいサイトを見つけると:

- ポジティブ インジケータ トーンが鳴ります。

無線機が新しいサイトを検索できない場合:

- ネガティブ インジケータ トーンが鳴ります。

サイト ロック オン/オフ

オンに切り替えた場合、無線機は現在のサイトのみを検索します。オフに切り替えた場合、無線機は現在のサイトに加え、他のサイトも検索します。

プログラムされた **【サイト ロック】** ボタンを押します。

【サイト ロック】 機能をオンに切り替えると、

- ポジティブ インジケータ トーンが聞こえて、無線機が現在のサイトにロックされていることを示しています。
- ディスプレイに『サイト ロック済み』と表示されます。



【サイト ロック】 機能をオフに切り替えると、



- ネガティブ インジケータ トーンが聞こえます。無線機のロックが解除されていることを示しています。
- ディスプレイに『サイト ロックかいじょ』と表示されます。



隣接サイトのリストへのアクセス

この機能では、現在のホームサイトに隣接するサイトのリストをチェックできます。下記の手順に従って、隣接サイトのリストにアクセスします。

- 1  を押してメニューにアクセスします。

- 2  または  を押して【せってい】に移動します。 を押して選択します。

- 3  または  を押して【きき じょうほう】に移動します。 を押して選択します。

- 4  または  を押して、【隣接サイト】に移動します。 を押して選択します。

セキュリティ

この機能では、システム内の任意の無線機の有効、無効を切り替えられます。

たとえば、盗難にあった無線機を無効にして不正ユーザーが使用できないようにし、無線機を回収したら有効にできます。

無線機を有効または無効にする方法には、認証を使用する方法と認証を使用しない方法の2つがあります。

認証を伴う無線機の無効化は、購入可能な機能です。認証を伴う無線機の無効化では、無線機を有効化または無効化する際に検証が必要です。無線機で、ユーザー認証を使用してターゲットの無線機に対してこの機能を開始する場合、パスフレーズが必要です。パスフレーズは、CPS を使用して、ターゲットの無線機に事前にプログラムしておきます。

無線機を有効または無効にする手順の途中で  を押すと、承認を受信できなくなります。





注記:

詳細については、ディーラーまたはシステム管理者にご確認ください。

無線機の無効化

下記の手順に従って、無線機を無効にします。

- 1 プログラムされた **[無線停止]** ボタンを押します。

2  または  を押して必要なエリアまたは ID に移動します。

3  を押して選択します。下記のいずれかの状態になります。

- ディスプレイに経過に関するミニ通知が表示され、要求が処理中であることが示されます。緑色の LED が点滅します。
- パスフレーズ画面が表示されます。

パスフレーズを入力します。  を押して次の操作へ進みます。

- パスフレーズが正しい場合、ディスプレイに経過に関するミニ通知が表示され、要求が処理中であることが示されます。緑色の LED が点灯します。
 - パスフレーズが正しくない場合、ディスプレイにネガティブミニ通知が表示され、前の画面に戻ります。
-

4 確認応答を待ちます。

正常に行われた場合:

- ポジティブ インジケータ トーンが鳴ります。

- ディスプレイにポジティブ ミニ通知が表示されます。

正常に行われなかった場合:



- ネガティブ インジケータ トーンが鳴ります。
 - ディスプレイにネガティブ ミニ通知が表示されます。
-



連絡先リストを使用した無線機の無効化





下記の手順に従って、連絡先リストを使用して無線機を無効にします。

1  を押してメニューにアクセスします。

2  または  を押して [れんらくさき] に移動します。  を押して選択します。

3  または  を押して必要なエリアまたは ID に移動します。  を押して選択します。

4  または  を押して『むせんていし』に移動します。

5  を押して選択します。下記のいずれかの状態になります。

- ディスプレイに経過に関するミニ通知が表示され、要求が処理中であることが示されます。緑色のLEDが点滅します。
- パスフレーズ画面が表示されます。

パスフレーズを入力します。  を押して次の操作へ進みます。

- パスフレーズが正しい場合、ディスプレイに経過に関するミニ通知が表示され、要求が処理中であることが示されます。緑色のLEDが点灯します。
 - パスフレーズが正しくない場合、ディスプレイにネガティブミニ通知が表示され、前の画面に戻ります。
-

6 確認応答を待ちます。

正常に行われた場合:

- ポジティブインジケータトーンが鳴ります。

- ディスプレイにポジティブミニ通知が表示されます。



正常に行われなかった場合:



- ネガティブインジケータトーンが鳴ります。
 - ディスプレイにネガティブミニ通知が表示されます。
-



ダイヤルを使用した無線機の無効化

下記の手順に従って、ダイヤルを使用して無線機を無効にします。

1  を押してメニューにアクセスします。



2  または  を押して『れんらくさき』に移動します。  を押して選択します。

3  または  を押して『ダイヤル』に移動します。  を押して選択します。

- 4  または  を押して『むせんきばんごう』に移動します。  を押して選択します。

テキスト行の 1 行目に『むせん ID:』と表示されます。

- 5 無線機の ID を入力し、  を押して先に進みます。

- 6  または  を押して『むせんていし』に移動します。

- 7  を押して選択します。下記のいずれかの状態になります。

- ディスプレイに経過に関するミニ通知が表示され、要求が処理中であることが示されます。緑色の LED が点滅します。
- パスフレーズ画面が表示されます。

パスフレーズを入力します。  を押して次の操作へ進みます。

- パスフレーズが正しい場合、ディスプレイに経過に関するミニ通知が表示され、要求が処理中

であることが示されます。緑色の LED が点灯します。

- パスフレーズが正しくない場合、ディスプレイにネガティブミニ通知が表示され、前の画面に戻ります。

- 8 確認応答を待ちます。

正常に行われた場合:

- ポジティブインジケータトーンが鳴ります。
- ディスプレイにポジティブミニ通知が表示されます。



正常に行われなかった場合:

- ネガティブインジケータトーンが鳴ります。
- ディスプレイにネガティブミニ通知が表示されます。

無線機の有効化

下記の手順に従って、無線機を有効にします。

- 1 プログラムされた **[停止解除]** ボタンを押します。

2  または  を押して必要なエリアまたは ID に移動します。

3  を押して選択します。下記のいずれかの状態になります。

- ディスプレイには【むせんオン】および無線機のエリアまたは ID が表示されます。緑色の LED が点灯します。
- パスフレーズ画面が表示されます。

パスフレーズを入力します。  を押して次の操作へ進みます。

- パスフレーズが正しい場合、ディスプレイに経過に関するミニ通知が表示され、要求が処理中であることが示されます。緑色の LED が点灯します。
 - パスフレーズが正しくない場合、ディスプレイにネガティブミニ通知が表示され、前の画面に戻ります。
-

4 確認応答を待ちます。

正常に行われた場合:

- ポジティブインジケータトーンが鳴ります。

- ディスプレイにポジティブミニ通知が表示されます。

正常に行われなかった場合:



- ネガティブインジケータトーンが鳴ります。
 - ディスプレイにネガティブミニ通知が表示されます。
-

連絡先リストを使用した無線機の有効化





下記の手順に従って、連絡先リストを使用して無線機を有効にします。

1  を押してメニューにアクセスします。

2  または  を押して【れんらくさき】に移動します。  を押して選択します。

3  または  を押して必要なエリアまたは ID に移動します。  を押して選択します。

4  または  を押して【ていしかいじょ】に移動します。

5  を押して選択します。下記のいずれかの状態になります。

- 緑色の LED が点滅します。ディスプレイには【むせんオン】および無線機のエイリアスまたは ID が表示されます。緑色の LED が点灯します。
- パスフレーズ画面が表示されます。

パスフレーズを入力します。  を押して次の操作へ進みます。

- パスフレーズが正しい場合、ディスプレイに経過に関するミニ通知が表示され、要求が処理中であることが示されます。緑色の LED が点灯します。
 - パスフレーズが正しくない場合、ディスプレイにネガティブミニ通知が表示され、前の画面に戻ります。
-

6 確認応答を待ちます。

正常に行われた場合:

- ポジティブ インジケータ トーンが鳴ります。

- ディスプレイにポジティブ ミニ通知が表示されます。



正常に行われなかった場合:



- ネガティブ インジケータ トーンが鳴ります。
 - ディスプレイにネガティブ ミニ通知が表示されます。
-

ダイヤルを使用した無線機の有効化

下記の手順に従って、ダイヤルを使用して無線機を有効にします。

1  を押してメニューにアクセスします。

2  または  を押して【れんらくさき】に移動します。  を押して選択します。



3  または  を押して【ダイヤル】に移動します。  を押して選択します。

4  または  を押して【こべつコール】に移動

します。  を押して選択します。

テキスト行の 1 行目に【むせん ID:】と表示されます。

5 無線機の ID を入力し、  を押して先に進みます。

6  または  を押して【ていしかいじよ】に移動します。

7  を押して選択します。下記のいずれかの状態になります。

- 緑色の LED が点滅します。ディスプレイには【むせんオン】および無線機のエイリアスまたは ID が表示されます。緑色の LED が点灯します。
- パスフレーズ画面が表示されます。

パスフレーズを入力します。  を押して次の操作へ進みます。

- パスフレーズが正しい場合、ディスプレイに経過に関するミニ通知が表示され、要求が処理中

であることが示されます。緑色の LED が点灯します。

- パスフレーズが正しくない場合、ディスプレイにネガティブミニ通知が表示され、前の画面に戻ります。

8 確認応答を待ちます。

正常に行われた場合:

- ポジティブインジケータトーンが鳴ります。
- ディスプレイにポジティブミニ通知が表示されます。

正常に行われなかった場合:

- ネガティブインジケータトーンが鳴ります。
- ディスプレイにネガティブミニ通知が表示されます。

ローン ワーカー

この機能を使用すると、事前に定義した期間中にユーザー操作 (無線機のボタンの押下やチャンネル選択など) がない場合に、緊急アラームを発生させることができます。

プログラムされた期間にユーザーによる操作がなく、無操作タイマーの時間が経過すると、無線機は音声インジケータでユーザーに最初の警告を発します。

事前に定義した通知タイマーの時間が経過しても確認応答がない場合に、無線機から緊急アラームが発せられます。

この機能には、下記の緊急アラームのいずれか 1 つのみが割り当てられます。

- 緊急アラーム
- 通話による緊急アラーム
- 音声ガイドおよび緊急アラーム 

無線機は、緊急状態のままとなり、操作が行われるまで音声メッセージの送信が継続します。緊急状態の終了方法の詳細については、「[緊急操作 ページ 430](#)」を参照してください。



注記:

この機能は、この機能が有効である無線機に限られます。詳細については、ディーラーまたはシステム管理者にご確認ください。

Bluetooth

Bluetooth 接続を介して、お使いの無線機と Bluetooth 対応デバイス (アクセサリ) を連携できます。お使いの無線機では、Motorola Solutions 製および COTS (市販既製品) の両方の Bluetooth 対応デバイスをサポートしています。

Bluetooth は、直線距離 10 メートル (32 フィート) の範囲内で動作します。これは、無線機と Bluetooth 対応デバイスとの間に障害物が何もない場合の距離です。信頼性を高めるために、Motorola Solutions では無線機とアクセサリを離さないことをお勧めします。

受信不良地域では、音声とトーン両方が「不明瞭」または「割れて」聞こえるようになります。この問題を解決するには、無線機と Bluetooth 対応デバイスを規定の 10 メートル以内に近づけて、明瞭な音声受信を再確立してください。無線機の Bluetooth 機能の最大出力は、10 メートル範囲で 2.5mW (4dBm) です。

無線機は、異なる種類の Bluetooth 対応デバイスとの Bluetooth 接続を同時に 3 接続までサポートできます。たとえば、ヘッドセット、スキャナ、および PTT 専用デバイス (POD) は同時に接続できます。同じ種類の複数の Bluetooth 対応デバイスには、同時に接続できません。

Bluetooth 対応デバイスの全機能の詳細については、個々の Bluetooth 対応デバイスのユーザー マニュアルを参照してください。

**注記:**

CPS 経由で無効にされている場合、すべての Bluetooth 関連機能が無効になり、Bluetooth 機器データベースは消去されます。

Bluetooth のオン/オフの切り替え

下記の手順に従って、Bluetooth のオンとオフを切り替えます。

- 1 を押してメニューにアクセスします。
- 2 または を押して [Bluetooth] に移動します。 を押して選択します。
- 3 または を押して [ステータス] に移動します。 を押して選択します。
ディスプレイに [オン] と [オフ] が表示されます。
現在のステータスは で示されます。
- 4 以下のいずれか 1 つの手順を実行します。

- または を押して [オン] に移動します。 を押して選択します。ディスプレイで が [オン] の隣に表示されます。
- または を押して [オフ] に移動します。 を押して選択します。ディスプレイで が [オフ] の隣に表示されます。









Bluetooth デバイスへの接続



下記の手順に従って、Bluetooth デバイスに接続します。

Bluetooth 対応デバイスの電源を入れ、ペアリングモードにします。

- 1 を押してメニューにアクセスします。
- 2 または を押して [Bluetooth] に移動します。 を押して選択します。
- 3 または を押して [デバイス] に移動します。 を押して選択します。

4 以下のいずれか 1 つの手順を実行します。

-  または  を押して必要なデバイスに移動します。  を押して選択します。
-  または  を押して【デバイス サーチ】に移動し、使用できるデバイスを見つけます。
 または  を押して必要なデバイスに移動します。  を押して選択します。

5  または  を押して【せつぞく】に移動します。  を押して選択します。

ペアリングを完成させるには、Bluetooth 対応デバイスでさらに手順が必要になることがあります。

Bluetooth 対応デバイスのユーザー マニュアルを参照してください。

ディスプレイに【<デバイス> せつぞくちゅう】と表示されます。

確認応答を待ちます。
正常に行われた場合:

- ポジティブ インジケータ トーンが鳴ります。

- ディスプレイに【<デバイス> せつぞくずみ】と **[Bluetooth 接続済み]** アイコンが表示されます。
- 接続されたデバイスに加えて、ディスプレイに  が表示されます。

正常に行われなかった場合:

- ネガティブ インジケータ トーンが鳴ります。
- ディスプレイに【せつぞくしっばい】と表示されます。



注記:

ピンコードが必要な場合は、「[パスワードを使用した無線機へのアクセス ページ 186](#)」を参照してください。



検出可能モードでの Bluetooth デバイスへの接続

下記の手順に従って、検出可能モードで Bluetooth デバイスに接続します。

Bluetooth 対応デバイスの電源を入れ、ペアリング モードにします。

1

 を押してメニューにアクセスします。

2  または  を押して [Bluetooth] に移動します。  を押して選択します。

3  または  を押して [Find Me] に移動します。  を押して選択します。 無線機が、プログラムされた期間に他の Bluetooth 対応デバイスで検出可能になります。これを検出可能モードと呼びます。

確認応答を待ちます。
正常に行われた場合:

- ポジティブインジケータ トーンが鳴ります。
- ディスプレイに [《デバイス》 せつぞくずみ] と [Bluetooth 接続済み] アイコンが表示されます。
- 接続されたデバイスに加えて、ディスプレイに  が表示されます。



正常に行われなかった場合:



- ネガティブインジケータ トーンが鳴ります。
- ディスプレイに [せつぞくしっぱい] と表示されます。



Bluetooth デバイスからの切断



下記の手順に従って、Bluetooth デバイスから切断します。

1  を押してメニューにアクセスします。

2  または  を押して [Bluetooth] に移動します。  を押して選択します。

3  または  を押して [デバイス] に移動します。  を押して選択します。

4  または  を押して必要なデバイスに移動します。  を押して選択します。

5  または  を押して [せつだん] に移動します。  を押して選択します。

ディスプレイに [《デバイス》 からせつだんちゆう] と表示されます。

**注記:**

切断するには、Bluetooth 対応デバイスでさらに手順が必要になることがあります。

Bluetooth 対応デバイスの各ユーザー マニュアルを参照してください。

確認応答を待ちます。

- トーンが鳴ります。
- ディスプレイに「[<デバイス> せつだんずみ]」と表示され、**[Bluetooth 接続済み]** アイコンが消えます。
- 接続されていたデバイスの横から ✓ が消えます。

内部無線機スピーカと Bluetooth デバイスの間のオーディオ ルートの切り替え

下記の手順に従って、内部無線機スピーカと外部 Bluetooth デバイスの間でオーディオ ルートを切り替えます。

プログラムされた **[Bluetooth オーディオ切り替え]** ボタンを押します。

ディスプレイに次のいずれかの結果が表示されます。

- トーンが鳴ります。ディスプレイに「おんせい>むせんき」と表示されます。

- トーンが鳴ります。ディスプレイに「おんせい>Bluetooth」と表示されます。

デバイスの詳細の表示



下記の手順に従って、無線機でデバイスの詳細を表示します。



- 1 を押してメニューにアクセスします。
- 2 または を押して [Bluetooth] に移動します。 を押して選択します。
- 3 または を押して [デバイス] に移動します。 を押して選択します。
- 4 または を押して必要なデバイスに移動します。 を押して選択します。
- 5 または を押して [しょうさい] に移動します。 を押して選択します。



デバイス名の削除



Bluetooth 対応デバイスのリストから切断済みデバイスを削除できます。

- 1  を押してメニューにアクセスします。

- 2  または  を押して [Bluetooth] に移動します。  を押して選択します。

- 3  または  を押して [デバイス] に移動します。  を押して選択します。

- 4  または  を押して必要なデバイスに移動します。  を押して選択します。



- 5  または  を押して [さくじょ] に移動します。  を押して選択します。 ディスプレイに [デバイスさくじょずみ] と表示されます。



Bluetooth マイクゲイン



この機能により、ユーザーは接続された Bluetooth 対応デバイスのマイクゲイン値を調整できます。

- 1  を押してメニューにアクセスします。

- 2  または  を押して [Bluetooth] に移動します。  を押して選択します。

- 3  または  を押して [BT マイクゲイン] に移動します。  を押して選択します。

- 4  または  を押して [BT マイクゲイン] タイプおよび現在の値に移動します。  を押して選択します。 ここで値を編集できます。

- 5  または  を押して値を増減します。  を押して選択します。

屋内位置







注記:





屋内位置機能は、最新のソフトウェアおよびハードウェアを搭載したモデルにのみ適用されます。詳細については、ディーラーまたはシステム管理者にご確認ください。

屋内位置機能を使用して、無線機ユーザーの位置を追跡できます。屋内位置が有効になっていると、無線機は限定的に検出可能なモードになります。無線機を探して位置を特定するために、専用ビーコンが使用されます。

屋内位置のオンとオフ

屋内位置をオンまたはオフにするには、次の操作のいずれかを実行します。

- メニューからこの機能にアクセスします。
 - a.  を押してメニューにアクセスします を押します。
 - b.  または  を押して [Bluetooth] に移動し、 を押して選択します。

- c.  または  を押して [屋内] に移動し、 を押して選択します。
- d.  を押して [屋内] をオンにします。
ディスプレイに [屋内オン] と表示されます。ポジティブインジケータトーンが鳴ります。下記のいずれかの状態になります。
 - 成功すると、[屋内位置利用可能] アイコンが [ホーム] 画面に表示されます。
 - 失敗すると、ディスプレイに [屋内オン失敗] と表示されます。ネガティブインジケータトーンが鳴ります。
- e.  を押して屋内をオフにします。
ディスプレイに [屋内オフ] と表示されます。ポジティブインジケータトーンが鳴ります。下記のいずれかの状態になります。
 - 成功すると、[屋内位置利用可能] アイコンが [ホーム] 画面から消えます。

- 失敗すると、ディスプレイに【屋内オフ失敗】と表示されます。ネガティブインジケータトーンが鳴ります。
- プログラムされたボタンを使用してこの機能にアクセスします。
 - プログラムされた【屋内】ボタンを長押しして屋内をオンにします。

ディスプレイに【屋内オン】と表示されます。ポジティブインジケータトーンが鳴ります。下記のいずれかの状態になります。

 - 成功すると、【屋内位置利用可能】アイコンが【ホーム】画面に表示されます。
 - 失敗すると、ディスプレイに【屋内オン失敗】と表示されます。失敗すると、ネガティブインジケータトーンが鳴ります。
 - プログラムされた【屋内】ボタンを押して屋内配置をオフにします。

ディスプレイに【屋内オフ】と表示されます。ポジティブインジケータトーンが鳴ります。下記のいずれかの状態になります。

- 成功すると、【屋内位置利用可能】アイコンが【ホーム】画面から消えます。
- 失敗すると、ディスプレイに【屋内オフ失敗】と表示されます。失敗すると、ネガティブインジケータトーンが鳴ります。



屋内位置ビーコン情報へのアクセス

下記の手順に従って、屋内位置ビーコン情報にアクセスします。

-  を押してメニューにアクセスします。を押します。

-  または  を押して【Bluetooth】に移動し、 を押して選択します。

-  または  を押して【屋内】に移動し、 を押して選択します。

- 4  または  を押して【ビーコン】に移動して、 を押して選択します。
-

ディスプレイにビーコン情報が表示されます。

通知リスト

無線機には、未読のメッセージ、テレメータメッセージ、不在着信やページングなど、チャンネル上で未読のイベントをすべて収集する通知リストがあります。

通知リストにイベントが1件以上あると、ディスプレイに【おしらせ】アイコンが表示されます。



リストでは、最大40の未読イベントを使用できます。リストがいっぱいになると、自動的に最も古いイベントが次のイベントで置き換えられます。これらのイベントは、読まれた後、通知リストから削除されます。



テキストメッセージ、不在着信、およびページングイベントの場合、通知の最大数は、テキストメッセージで30件、不在着信またはページングで10件です。この最大数は、個々の機能（JOB チケット、テキストメッセージ、不在着信、またはページング）のリスト容量に応じて異なります。

通知リストへのアクセス

下記の手順に従って、無線機で通知リストにアクセスします。

- 1  を押してメニューにアクセスします。

- 2  または  を押して【おしらせ】に移動します。 を押して選択します。

- 3  または  を押して必要なイベントに移動します。 を押して選択します。

ホーム画面に戻るには、 を長押しします。

オートレンジ トランスポンダ システム



オートレンジ トランスポンダ システム (ARTS) はアナログのみの機能で、無線機が ARTS を搭載した他の無線機の通信圏外にあるときに通知するよう設計されています。

ARTS を搭載した無線機は、定期的に信号の送受信を行って、互いに通信圏内にあることを確認します。

無線機は、次のようなステータスを示します。

初回警告

トーンが鳴ります。

ディスプレイで、チャンネル エイリアスの後に【エリアない】が表示されます。

ARTS 通信圏内警告

プログラムされている場合はトーンが鳴ります。

ディスプレイで、チャンネル エイリアスの後に【エリアない】が表示されます。

ARTS 通信圏外警告

トーンが鳴ります。赤色の LED が素早く点滅します。

ディスプレイに、【けんがい】とホーム画面が交互に表示されます。



注記:

詳細については、ディーラーまたはシステム管理者にご確認ください。

エア接続プログラミング

ディーラーは、物理的に接続せずにエア接続プログラミング (OTAP) 経由で無線機をリモートから更新できます。さらに、一部の設定も OTAP から設定できます。

無線機が OTAP を実行中のときは、緑色の LED が点滅します。

大量データを受信した場合:

- ディスプレイに **[大量データ]** アイコンが表示されます。
- チャンネルがビジー状態になります。
- **PTT** ボタンを押すと、ネガティブトーンが鳴ります。

OTAP が完了した場合 (構成に依存):

- トーンが鳴ります。ディスプレイに【アップデート リセット】と表示されます。電源がオフになってからオンになり、無線機が再起動します。
- 【リスタート】または【えんきする】を選択できます。【えんきする】を選択すると、前の画面に戻ります。自動再起動が行われるまで、ディスプレイに **[OTAP 遅延タイマー]** アイコンが表示されます。

自動再起動後に無線機の電源が入った場合:

- 成功すると、ディスプレイに【ソフト アップデートかんりょう】と表示されます。
- 失敗すると、ディスプレイに【ソフト アップデートしつぱい】と表示されます。

更新されたソフトウェアバージョンについては、「[ソフトウェア更新情報のチェック ページ 224](#)」を参照してください。

そうしんよくせい

送信抑制機能を使うことで、無線機からの送信をすべてブロックできます。





注記:

送信抑制モードでは Bluetooth および Wi-Fi 機能を利用できます。

送信抑制の有効化

下記の手順に従って、送信抑制を有効にします。

下記の作業のどちらかを実行します。

-  または  を押して【TX よくせい】に移動し、 を押して選択します。

- **送信抑制**プログラム可能ボタンを押します。

- ポジティブ インジケータ トーンが鳴ります。
- ディスプレイに【TX よくせいオン】と表示されます。





注記:

送信抑制のステータスは無線機の電源投入後に変更されません。

送信抑制の無効化

下記の手順に従って、送信抑制を無効にします。

下記の作業のどちらかを実行します。

-  または  を押して【TX よくせい】に移動し、 を押して選択します。
- **送信抑制**プログラム可能ボタンを押します。



- ネガティブ インジケータ トーンが鳴ります。送信が通常操作に戻ります。
- ディスプレイに【TX よくせい オフ】と表示されます。



サードパーティ周辺機器接続モードの選択



下記の手順に従って、以下のいずれかのサードパーティ周辺機器接続モードを選択します。



- Motorola Solutions
- PC とオーディオ
- データ アクセサリ
- テレメータ
- ジェネリック

1  を押してメニューにアクセスします。

2  または  を押して『せってい』に移動します。  を押して選択します。

3  または  を押して『きのうせってい』に移動します。  を押して選択します。

4  または  を押して、『ケーブル タイプ』に移動します。  を押して選択します。

5  または  を押して必要な接続モードに移動します。  を押して選択します。
ディスプレイには選択された接続モードが表示されます。画面は前のメニューに戻ります。

受信信号強度インジケータ

この機能を使用して、受信信号強度インジケータ (RSSI) 値を表示できます。

ディスプレイでは、**[RSSI]** アイコンが右上端に表示されません。**[RSSI]** アイコンの詳細については、「[ディスプレイアイコン](#)」を参照してください。

RSSI 値の表示

4 ウェイナビゲーション キーパッド マイク (Motorola Solutions 部品番号 RMN5127_) を無線機に取り付けます。

ホーム画面で、4ウェイナビゲーションキーパッドマイクを使用して、◀ を3回押し、すぐに ▶ を3回押しします。

ディスプレイに現在のRSSI値が表示されます。

ホーム画面に戻るには、 を長押しします。

パスワードロック機能

本機能では、デバイスがオンになるたびにパスワードの入力を求めることによって、無線機へのアクセスを制限できます。

キーパッドマイクまたはスクロールアップ/スクロールダウンボタンを使用して、パスワードを入力します。

パスワードを使用した無線機へのアクセス



下記の手順に従って、パスワードを使用して無線機にアクセスします。

- 1 現在の4桁のパスワードを入力します。



注記:

緊急 フットスイッチを使用すると、無線機にアクセスするためのパスワード入力キャンセルされます。

- キーパッドマイクを使用します。
-  または  を押して各桁の数値を編集し、 を押して値を入力し、次の桁に移動します。

2

- 2  を押してパスワードを入力します。

処理が正常に行われると、無線機の電源が入ります。正常に行われなかった場合:

- 最初と2回目の試行の後、ディスプレイに【パスワードふてきごう】と表示されます。[ステップ1](#)を繰り返します。
- 3回試行すると、ディスプレイに【パスワードふてきごう】に続き、【むせんきロックずみ】と表示されます。トーンが鳴ります。黄色のLEDが2回点滅します。無線機は15分間ロック状態になります。

**注記:**

ロック状態の無線機は、オン/オフ/音量コントロールノブおよびプログラムされた【バックライト】ボタンからの入力にのみ反応します。

15分待ってからパスワードを使用した無線機へのアクセス ページ 186 の手順を繰り返して、無線機にアクセスします。

ロック状態の無線機をロック解除する











ロック状態の無線機は、コールを受信できません。下記の手順に従って、ロック状態の無線機をロック解除します。



以下のいずれか 1 つの手順を実行します。

- 無線機の電源がオンになっている場合には、15分待ってから **パスワードを使用した無線機へのアクセス ページ 186** の手順を繰り返して、無線機にアクセスします。
- 無線機の電源がオフになっている場合には、無線機の電源をオンにします。ロック状態の 15分タイマーが再起動されます。トーンが鳴ります。黄色の LED が 2 回点滅します。ディスプレイに【むせんきロックずみ】と表示されます。

パスワードロックのオンとオフの切り替え

下記の手順に従って、無線機でパスワードロックのオンとオフを切り替えます。







-  を押してメニューにアクセスします。
-  または  を押して【せってい】に移動します。  を押して選択します。
-  または  を押して【きのうせってい】に移動します。  を押して選択します。
-  または  を押して【パスワード ロック】に移動します。  を押して選択します。
- 現在の 4 桁のパスワードを入力します。

- キーパッド マイクを使用します。
-  または  を押して各桁の数値を編集し、 を押して値を入力し、次の桁に移動します。数値を押すたびに、ポジティブ インジケータ トーンが鳴ります。

6 を押してパスワードを入力します。

パスワードが正しくない場合は、ディスプレイに【パスワードふてきごう】と表示され、自動的に前のメニューへ戻ります。

7 以下のいずれか 1 つの手順を実行します。

-  または  を押して【オン】に移動します。 を押して選択します。ディスプレイの【オン】の隣に  が表示されます。
-  または  を押して【オフ】に移動します。 を押して選択します。

ディスプレイの【オフ】の隣に  が表示されません。

パスワードの変更

下記の手順に従って、無線機でパスワードを変更します。

1 を押してメニューにアクセスします。



2 または を押して【せってい】に移動します。 を押して選択します。

3 または を押して【きのうせってい】に移動します。 を押して選択します。

4 または を押して【パスワード ロック】に移動します。 を押して選択します。

5 現在の 4 桁のパスワードを入力し、 を押して次に進みます。

パスワードが正しくない場合は、ディスプレイに【パスワードふてきごう】と表示され、自動的に前のメニューへ戻ります。

6  または  を押して【パスワード へんこう】に移動します。  を押して選択します。

7 新しい4桁のパスワードを入力し、  を押して次に進みます。

8 新しい4桁のパスワードをもう一度入力し、  を押して次に進みます。

処理が正常に行われると、ディスプレイに【パスワードへんこうずみ】と表示されます。

処理が正常に行われなかった場合は、ディスプレイに【パスワードふてきごう】と表示されます。

前のメニューに自動的に戻ります。

正面パネル設定



正面パネル設定 (FPC) の特定の機能パラメータをカスタマイズして無線機を効果的に利用できます。



正面パネル設定モードの開始

下記の手順に従って、無線機で正面パネル プログラミングモードに入ります。

 を長く押しすと、いつでもホーム画面に戻ります。



1  を押してメニューにアクセスします。



2  または  を押して【せってい】に移動します。  を押して選択します。

3  または  を押して【PGM Radio】に移動します。  を押して選択します。

FPP モード パラメータの編集

機能パラメータをナビゲートするときに必要に応じて次のボタンを使用します。

-   、 - オプションをスクロールしたり、値を増減したり、垂直にナビゲートしたりします。

-  – オプションを選択するか、サブメニューを入力します。
-  – 短押しすると、前のメニューに戻るか、選択画面を終了することができます。長押しすると、ホーム画面に戻ります。

Wi-Fi 操作

この機能で、Wi-Fi ネットワークをセットアップして接続できます。Wi-Fi は、無線機のファームウェア、コードプラグ、言語パックや音声ガイドなどのリソースの更新をサポートします。



注記:

この機能が適用されるモデルは、XiR M8668i/CM7668i のみです。

Wi-Fi® は Wi-Fi Alliance® の登録商標です。

お使いの無線機は、WEP/WPA/WPA2 パーソナル Wi-Fi および WPA/WPA2 エンタープライズ Wi-Fi のネットワークに対応しています。

WEP/WPA/WPA2 パーソナル Wi-Fi ネットワーク

事前共有キー (パスワード) ベースの認証を使用します。

事前共有キーは、メニューまたは CPS/RM を使用して入力できます。

WPA/WPA2 エンタープライズ Wi-Fi ネットワーク

証明書ベースの認証を使用します。

無線機を証明書使って事前設定しておく必要があります。



注記:

WPA/WPA2 エンタープライズ Wi-Fi ネットワークへの接続については、ディーラーまたはシステム管理者に確認してください。

プログラムされた **[Wi-Fi オン/オフ]** ボタンがディーラーまたはシステム管理者により割り当てられます。無線機がどのようにプログラムされているかについては、ディーラーまたはシステム管理者に確認してください。

プログラムされた **[Wi-Fi オン/オフ]** ボタンの音声ガイドは、ユーザーの要件に応じて、CPS を使用してカスタマイズできます。詳細については、ディーラーまたはシステム管理者にご確認ください。



注記:

スーパーバイザ無線機を使用して、リモートで Wi-Fi をオンまたはオフにできます ([スーパーバイザ無線機を使用して Wi-Fi のオン/オフを切り替える](#) を参照)。詳細については、ディーラーまたはシステム管理者にご確認ください。



Wi-Fi のオン/オフの切り替え



下記の手順に従って、Wi-Fi のオンとオフを切り替えます。

- 1 プログラムされた **[Wi-Fi オン/オフ]** ボタンを押します。Wi-Fi のオンまたは Wi-Fi のオフの音声ガイドが聴こえます。

- 2 メニューを使用してこの機能にアクセスします。

a  を押してメニューにアクセスします を押します。

b  または  を押して **[Wi-Fi]** に移動し、
 を押して選択します。

c  または  を押して **[Wi-Fi オン]** に移動し、
 を押して選択します。

d  を押して、Wi-Fi をオン/オフにします。

Wi-Fi がオンの場合、ディスプレイで **[ゆうこう]** の隣に  が表示されます。

Wi-Fi がオフの場合は、**[ゆうこう]** の隣から  が消えます。



指定された無線機を使用してリモートで Wi-Fi をオンまたはオフにする (個別制御)



下記の手順に従って、個別制御 (1 対 1) でリモートで Wi-Fi のオン/オフを切り替えます。







注記:

特定の CPS 設定を持つ無線機のみがこの機能をサポートします。詳細については、ディーラーまたはシステム管理者にご確認ください。

- 1 以下のいずれか 1 つの手順を実行します。
 - プログラム可能ボタンを長押しします。キーパッドを使用して **ID** と  を押して選択しますを入力します。ステップ 3 に進みます。
 -  を押してメニューにアクセスします を押します。

2  または  を押して【れんらくさき】に移動し、 を押して選択します。

3  または  を押して、【WiFi せいぎよ】にアクセスし、 を押して選択します。

4  または  を押して【オン】または【オフ】を選択します。

5  を押して選択します。

成功すると、ディスプレイにポジティブ ミニ通知が表示されます。

失敗すると、ディスプレイにネガティブ ミニ通知が表示されます。

指定された無線機を使用してリモートで Wi-Fi をオンまたはオフにする (グループコントロール)



下記の手順に従って、グループコントロール (1 対多) でリモートで Wi-Fi のオン/オフを切り替えます。







注記:



特定の CPS 設定を持つ無線機のみがこの機能をサポートします。詳細については、ディーラーまたはシステム管理者にご確認ください。

1  を押してメニューにアクセスします を押します。

2  または  を押して【れんらくさき】に移動し、 を押して選択します。

3  または  を押して必要な無線機のエリアスまたは ID を選択します。

4  または  を押して、【WiFi せいぎよ】にアクセスし、 を押して選択します。

5  または  を押して【オン】または【オフ】を選択します。

- 6  を押して選択します。

処理が正常に行われると、ディスプレイに『せいじょうにそうしん』と表示されます。

失敗すると、ディスプレイにネガティブミニ通知が表示されます。

ネットワーク アクセス ポイントへの接続

Wi-Fi をオンにすると、無線がネットワーク アクセス ポイントに接続します。









注記:



また、メニューからもネットワーク アクセス ポイントに接続できます。

WPA エンタープライズ Wi-Fi ネットワークのアクセス ポイントは、事前に設定されています。無線機がどのようにプログラムされているかについては、ディーラーまたはシステム管理者に確認してください。

- 1  を押してメニューにアクセスします を押します。

- 2  または  を押して [Wi-Fi] に移動し、
 を押して選択します。



- 3  または  を押して [ネットワーク] に移動して、
 を押して選択します。

- 4  または  を押してネットワーク アクセス ポイントに移動し、
 を押して選択します。



注記:

WPA エンタープライズ Wi-Fi で、ネットワーク アクセス ポイントが事前に設定されていない場合、『せつぞく』オプションは使用できません。

- 5  または  を押して [せつぞく] に移動し、
 を押して選択します。

- 6 WPA パーソナル Wi-Fi の場合、パスワードを入力して  を押します。

7 WPA エンタープライズ Wi-Fi の場合、パスワードは RM を使用して設定されます。

事前に設定されているパスワードが正しい場合、無線機は自動的に選択したネットワーク アクセス ポイントに接続します。

事前に設定したパスワードが正しくない場合、ディスプレイに【にんしょうエラー】と表示され、自動的に前のメニューへ戻ります。

接続に成功すると、無線に通知が表示され、ネットワーク アクセス ポイントがプロファイルリストに保存されます。

接続に失敗すると、無線のディスプレイに失敗通知画面が瞬時的に表示され、自動的に前のメニューへ戻ります。

Wi-Fi 接続ステータスの確認

下記の手順に従って、Wi-Fi 接続のステータスを確認します。

プログラムされた **[Wi-Fi ステータス照会]** ボタンを押し、音声ガイドで接続ステータスを確認します。Wi-Fi がオフ、

Wi-Fi がオンで接続なし、または Wi-Fi がオンで接続ありの音声ガイドが流れます。

- Wi-Fi がオフになっていると、ディスプレイに【Wi-Fi オフ】と表示されます。
- 無線機がネットワークに接続されていると、ディスプレイに【Wi-Fi オン】、【接続済み】と表示されます。
- Wi-Fi がオンになっているが、無線機がネットワークに接続されていない場合、【Wi-Fi オン】、【切断済み】と表示されます。

Wi-Fi ステータス照会結果の音声ガイドは、ユーザーの要件に応じて、CPS を使用してカスタマイズできます。詳細については、ディーラーまたはシステム管理者にご確認ください。













注記:

プログラムされた **[Wi-Fi ステータス照会]** ボタンがディーラーまたはシステム管理者によって割り当てられます。無線機がどのようにプログラムされているかについては、ディーラーまたはシステム管理者に確認してください。

ネットワーク リストの更新

下記の手順に従って、ネットワーク リストを更新します。

- メニューからネットワーク リストを更新するには、次の操作を実行します。
 - a.  を押してメニューにアクセスします を押します。
 - b.  または  を押して【WiFi】に移動し、
 を押して選択します。
 - c.  または  を押して【ネットワーク】に移動して、
 を押して選択します。
【ネットワーク】メニューに移動すると、ネットワーク リストが自動的に更新されます。
- 【ネットワーク】メニューをすでに移動している場合は、次の操作を実行してネットワーク リストを更新します。

 または  を押して【こうしん】に移動し、
 を押して選択します。

ネットワーク リストが更新され、最新のリストが表示されます。

ネットワークの追加









注記:



このタスクは、WPA エンタープライズ Wi-Fi ネットワークには適用されません。

使用可能なネットワークのリストに優先ネットワークがない場合は、次の操作を実行してネットワークを追加します。



1  を押してメニューにアクセスします を押します。

2  または  を押して【WiFi】に移動し、
 を押して選択します。

3  または  を押して【ネットワーク】に移動して、
 を押して選択します。

- 4  または  を押して [ネットワーク つか] に移動し、  を押して選択します。

- 5 サービス セット 識別子 (SSID) を入力して、  を押します。



- 6  または  を押して [ひらく] に移動し、  を押して選択します。



- 7 パスワードを入力して、  を押します。
無線機にポジティブ ミニ通知が表示され、ネットワークが正常に保存されたことが示されます。



ネットワーク アクセス ポイントの詳細の表示



ネットワーク アクセス ポイントの詳細を表示できます。

- 1  を押してメニューにアクセスします を押します。

- 2  または  を押して [WiFi] に移動し、  を押して選択します。

- 3  または  を押して [ネットワーク] に移動して、  を押して選択します。

- 4  または  を押してネットワーク アクセス ポイントに移動し、  を押して選択します。

- 5  または  を押して [しようさい] に移動し、  を押して選択します。



注記:

通常の WPA パーソナル Wi-Fi と WPA エンタープライズ Wi-Fi では、表示されるネットワーク アクセス ポイントの詳細は異なります。

WPA パーソナル Wi-Fi

接続済みのネットワーク アクセス ポイントについては、サービス セット 識別子 (SSID)、セキュリティ モード、メディア アクセス 制御 (MAC) アドレス、およびイ

インターネット プロトコル (IP) アドレスが無線機に表示されます。

接続されていないネットワーク アクセス ポイントについては、**SSID** およびセキュリティ モードが無線機に表示されます。

WPA エンタープライズ Wi-Fi

接続済みのネットワーク アクセス ポイントについては、**SSID**、セキュリティ モード、**ID**、拡張認証プロトコル (EAP) 方式、フェーズ 2 認証、証明書名、**MAC** アドレス、**IP** アドレス、ゲートウェイ、**DNS1**、および **DNS2** が無線機に表示されます。

接続されていないネットワーク アクセス ポイントについては、**SSID**、セキュリティ モード、**ID**、**EAP** 方式、フェーズ 2 認証、および証明書名が無線機に表示されます。



ネットワーク アクセス ポイントの削除









注記:



このタスクは、エンタープライズ Wi-Fi ネットワークには適用されません。



プロファイル リストのネットワーク アクセス ポイントを削除するには、次の操作を実行します。



- 1  を押してメニューにアクセスします。  を押しません。

- 2  または  を押して [WiFi] に移動し、 を押して選択します。

- 3  または  を押して [ネットワーク] に移動して、 を押して選択します。

- 4  または  を押して、選択したネットワーク アクセス ポイントに移動し、 を押して選択します。

- 5  または  を押して [さくじょ] に移動し、 を押して選択します。

- 6  または  を押して【はい】に移動し、 を押して選択します。

無線機にポジティブ ミニ通知が表示され、選択したネットワーク アクセス ポイントが正常に削除されたことが示されます。

ユーティリティ

この章では、無線機で使用できるユーティリティ機能の操作について説明します。

スケルチ レベル

信号強度が低い不要な通話や、通常背景雑音よりも強い雑音があるチャンネルを取り除くために、スケルチ レベルを調整できます。

通常

これはデフォルト設定です。



この設定では、不要な通話や背景雑音を取り除かれません。遠隔地からの通話も取り除かれる可能性があります。













注記:

この機能は、同じ周波数の市民バンド チャンネルには適用されません。













スケルチ レベルの設定

下記の手順に従って、無線機でスケルチ レベルを設定します。

- 以下のいずれか 1 つの手順を実行します。
 - プログラムされた【スケルチ】ボタンを押します。以下の手順をスキップします。
 -  を押してメニューにアクセスします。
-  または  を押して【せってい】に移動します。 を押して選択します。
-  または  を押して【きのうせってい】に移動します。 を押して選択します。

- 4  または  を押して【スケルチ】に移動します。  を押して選択します。

- 5 以下のいずれか 1 つの手順を実行します。

-  または  を押して【】に移動します。  を押して選択します。
ディスプレイの【】の隣に  が表示されます。
-  または  を押して【】に移動します。  を押して選択します。
ディスプレイの【】の隣に  が表示されます。

前のメニューに自動的に戻ります。

出力レベル

各チャンネルの出力設定の高低をカスタマイズできます。

つよめ

この設定では、かなり離れた場所にある無線機とも通信できるようになります。

少ない

この設定では、近い場所にある無線機と交信できます。







注記:



この機能は、同じ周波数の市民バンドチャンネルには適用されません。



出力レベルの設定

下記の手順に従って、無線機で出力レベルを設定します。





- 1 以下のいずれか 1 つの手順を実行します。
 - プログラムされた **【出力レベル】** ボタンを押します。以下の手順をスキップします。
 -  を押してメニューにアクセスします。





- 2  または  を押して【せってい】に移動します。  を押して選択します。

- 3  または  を押して【きのうせってい】に移動します。  を押して選択します。

4  または  を押して【でんげん】に移動します。  を押して選択します。

5 以下のいずれか 1 つの手順を実行します。

-  または  を押して【■■■■■】に移動します。  を押して選択します。
ディスプレイの【■■■■■】の隣に  が表示されます。

-  または  を押して【■□□□□】に移動します。  を押して選択します。
ディスプレイの【■□□□□】の隣に  が表示されます。

6 ホーム画面に戻るには、 を長押しします。



無線機トーン/アラートのオンとオフの切り替え



着信緊急警告トーン以外の、すべての無線機トーンやアラートは、必要に応じて有効化および無効化できます。下記



の手順に従って、無線機でトーン/アラートのオンとオフを切り替えます。



1 以下のいずれか 1 つの手順を実行します。

- プログラムされた【トーン/アラート】ボタンを押します。以下の手順をスキップします。
-  を押してメニューにアクセスします。

2  または  を押して【せってい】に移動します。  を押して選択します。

3  または  を押して【きのうせってい】に移動します。  を押して選択します。







4  または  を押して【トーン/アラート】に移動します。  を押して選択します。







5  または  を押して【ぜん トーン】に移動します。  を押して選択します。

- 6  を押して、すべてのトーンおよびアラートを無効または有効にします。ディスプレイに次のいずれかの結果が表示されます。
- 有効にすると、✓が【ゆうこう】の隣に表示されます。
 - 無効な場合、✓が【ゆうこう】の隣で非表示になります。

キー操作音のオンとオフの切り替え

下記の手順に従って、無線機でキー操作音のオンとオフを切り替えます。

- 1  を押してメニューにアクセスします。
-
- 2  または  を押して【せってい】に移動します。  を押して選択します。
-
- 3  または  を押して【きのうせってい】に移動します。  を押して選択します。



- 4  または  を押して【トーン/アラート】に移動します。  を押して選択します。
-
- 5  または  を押して【キーそうさおん】に移動します。  を押して選択します。
-
- 6  を押してキー操作音を有効または無効にします。ディスプレイに次のいずれかの結果が表示されます。
- 有効にすると、✓が【ゆうこう】の隣に表示されます。
 - 無効な場合、✓が【ゆうこう】の隣で非表示になります。



トーン/アラートのボリューム オフセット レベルの設定



この機能は、音声ボリュームを基準としてトーンまたはアラートのボリュームを調節できます。下記の手順に従っ



て、無線機でトーンとアラートのボリューム オフセット レベルを設定します。



- 1  を押してメニューにアクセスします。

- 2  または  を押して【せってい】に移動します。  を押して選択します。

- 3  または  を押して【きのうせってい】に移動します。  を押して選択します。



- 4  または  を押して【トーン/アラート】に移動します。  を押して選択します。

- 5  または  を押して【Vol オフセット】に移動します。  を押して選択します。

- 6  または  を押して必要なボリューム オフセット レベルに移動します。

対応する各ボリューム オフセット レベルのフィードバックトーンが鳴ります。



- 7 以下のいずれか 1 つの手順を実行します。



-  を押して選択します。必要な音量オフセットレベルが保存されます。
-  を押して終了します。変更が破棄されません。



通話許可トーンのオンとオフの切り替え



下記の手順に従って、無線機で通話許可トーンのオンとオフを切り替えます。

- 1  を押してメニューにアクセスします。

2  または  を押して【せってい】に移動します。 を押して選択します。

3  または  を押して【きのうせってい】に移動します。 を押して選択します。

4  または  を押して【トーン/アラート】に移動します。 を押して選択します。

5  または  を押して【きよか トーン】に移動します。 を押して選択します。

6  を押して通話許可トーンを有効または無効にします。

ディスプレイに次のいずれかの結果が表示されます。



- 有効にすると、 が【ゆうこう】の隣に表示されます。



- 無効な場合、 が【ゆうこう】の隣で非表示になります。



パワーアップトーンのオンとオフの切り替え



下記の手順に従って、無線機でパワーアップトーンのオンとオフを切り替えます。

1  を押してメニューにアクセスします。



2  または  を押して【せってい】に移動します。 を押して選択します。

3  または  を押して【きのうせってい】に移動します。 を押して選択します。

4  または  を押して【トーン/アラート】に移動します。 を押して選択します。

5  または  を押して [でんげんオン] に移動します。  を押して選択します。



6  を押してパワー アップ トーンを有効または無効にします。ディスプレイに次のいずれかの結果が表示されます。



- 有効にすると、 が [ゆうこう] の隣に表示されます。
 - 無効な場合、 が [ゆうこう] の隣で非表示になります。
-



メッセージ アラーム トーンの設定

連絡先リストの各エントリに対して、メッセージアラーム トーンを [1 かいのみ] または [くりかえし] にカスタマイズできます。下記の手順に従って、無線機でメッセージアラーム トーンを設定します。









1  を押してメニューにアクセスします。

2  または  を押して [れんらくさき] に移動します。  を押して選択します。

3  または  を押して必要なエイリアスまたは ID に移動します。  を押して選択します。

4  または  を押して [メッセージ アラーム] に移動します。  を押して選択します。



5 以下のいずれか 1 つの手順を実行します。



-  または  を押して [1 かいのみ] に移動します。  を押して選択します。ディスプレイの [1 かいのみ] の隣に  が表示されます。
 -  または  を押して [くりかえし] に移動します。  を押して選択します。ディスプレイの [くりかえし] の隣に  が表示されます。
-



表示モードの変更

必要に応じて、無線機の表示モードをデイとナイトの間で切り替えられます。この機能により、ディスプレイの色パレットが影響を受けます。下記の手順に従って、無線機の表示モードを変更します。



- 1 以下のいずれか 1 つの手順を実行します。
 - プログラムされた**表示モード** ボタンを押します。以下の手順をスキップします。
 -  を押してメニューにアクセスします。

- 2  または  を押して【せってい】に移動します。 を押して選択します。

- 3  または  を押して【きのうせってい】に移動します。 を押して選択します。

- 4  または  を押して【ひょうじ】に移動します。 を押して選択します。

ディスプレイに【デイモード】と【ナイトモード】が表示されます。



- 5  または  を押して必要な設定に移動します。 を押して選択します。



選択した設定の横に  が表示されます。



表示輝度の調整



下記の手順に従って、無線機の表示輝度を調整します。【あかるさじどう】が有効の場合、表示輝度は調整できません。

- 1 以下のいずれか 1 つの手順を実行します。
 - プログラムされた**【輝度】** ボタンを押します。以下の手順をスキップします。
 -  を押してメニューにアクセスします。

2  または  を押して【せってい】に移動します。 を押して選択します。

3  または  を押して【きのうせってい】に移動します。 を押して選択します。

4  または  を押して【きど】に移動します。 を押して選択します。
ディスプレイに進行状況バーが表示されます。



5  または  を押して表示輝度を増減します。 を押して選択します。
設定値は 1 から 8 まで変わります。



ホーンとライトのオンとオフの切り替え



無線機では、着信通話をホーンとライトで知らせることができます。この機能を有効にすると、着信通話があるたび

に車両のホーンが鳴り、車両のライトが点灯します。この機能は、ディーラーが無線機の背面アクセサリコネクタからインストールする必要があります。下記の手順に従って、無線機で全ホーンとライトのオン、オフを切り替えます。

- 1 以下のいずれか 1 つの手順を実行します。
 - プログラムされた【ホーン/ライト】ボタンを押します。以下の手順をスキップします。
 -  を押してメニューにアクセスします。
-

2  または  を押して【せってい】に移動します。 を押して選択します。







3  または  を押して【きのうせってい】に移動します。 を押して選択します。



4  または  を押して【ホーン/ライト】に移動します。 を押して選択します。

- 5  を押して [ホーン/ライト] を有効または無効にします。ディスプレイに次のいずれかの結果が表示されます。
- 有効にすると、✓が [ゆうこう] の隣に表示されます。
 - 無効な場合、✓が [ゆうこう] の隣で非表示になります。
-

LED インジケータのオンとオフの切り替え

下記の手順に従って、無線機で LED インジケータのオンとオフを切り替えます。

- 1  を押してメニューにアクセスします。
-
- 2  または  を押して [せってい] に移動します。  を押して選択します。
-
- 3  または  を押して [きのうせってい] に移動します。  を押して選択します。
-

- 4  または  を押して [LED ひょうじ] に移動します。  を押して選択します。
-



- 5  を押して LED 表示を有効または無効にします。
- ディスプレイに次のいずれかの結果が表示されません。
- 有効にすると、✓が [ゆうこう] の隣に表示されます。
 - 無効な場合、✓が [ゆうこう] の隣で非表示になります。
-



パブリック アドレス システムのオンとオフの切り替え



下記の手順に従って、無線機の内部パブリック アドレス (PA) システムを有効または無効にします。



- 1 以下のいずれか 1 つの手順を実行します。
- プログラムされた [パブリック アドレス] ボタンを押します。以下の手順をスキップします。

-  を押してメニューにアクセスします。
-

- 2  または  を押して [せってい] に移動します。  を押して選択します。
-











- 3  または  を押して [きのうせってい] に移動します。  を押して選択します。
-

- 4  または  を押して [パブリック アドレス] に移動します。  を押して選択します。
-

- 5  を押してパブリックアドレスを有効または無効にします。
- 有効にすると、 が [ゆうこう] の隣に表示されます。
 - 無効な場合、 が [ゆうこう] の隣で非表示になります。
-

外部パブリックアドレスシステムのオンとオフの切り替え







下記の手順に従って、無線機の外部パブリックアドレス (PA) システムを有効または無効にします。



- 1 以下のいずれか 1 つの手順を実行します。
- プログラムされた **[外部パブリックアドレス]** ボタンを押します。以下の手順をスキップします。
 -  を押してメニューにアクセスします。
-
- 2  または  を押して [せってい] に移動します。  を押して選択します。
-
- 3  または  を押して [きのうせってい] に移動します。  を押して選択します。
-
- 4  または  を押して [外部パブリック アドレス] に移動します。  を押して選択します。
-



- 5  を押して外部パブリックアドレスを有効または無効にします。
- 有効にすると、✓が【ゆうこう】の隣に表示されます。
 - 無効な場合、✓が【ゆうこう】の隣で非表示になります。
-

初期画面のオンとオフの切り替え

手順に従って、初期画面の有効、無効を切り替えることができます。

- 1  を押してメニューにアクセスします。
-
- 2  または  を押して【せってい】に移動します。  を押して選択します。
-
- 3  または  を押して【きのうせってい】に移動します。  を押して選択します。
-

- 4  または  を押して【ひょうじ】に移動します。  を押して選択します。
-

- 5  または  を押して【しよきがめん】に移動します。  を押して選択します。
-

- 6  を押して【しよきがめん】を有効または無効にします。



ディスプレイに次のいずれかの結果が表示されます。



- 有効にすると、✓が【ゆうこう】の隣に表示されます。
 - 無効な場合、✓が【ゆうこう】の隣で非表示になります。
-



言語の設定





下記の手順に従って、無線機で言語を設定します。

- 1  を押してメニューにアクセスします。
-

2  または  を押して【せってい】に移動します。 を押して選択します。

3  または  を押して【きのうせってい】に移動します。 を押して選択します。



4  または  を押して【げんご】に移動します。 を押して選択します。



5  または  を押して必要な言語に移動します。 を押して選択します。
選択した言語の横に  が表示されます。



ケーブルタイプの特定

下記の手順に従って、無線機で使用するケーブルのタイプを選択します。

1  を押してメニューにアクセスします。

2  または  を押して【せってい】に移動します。 を押して選択します。

3  または  を押して【きのうせってい】に移動します。 を押して選択します。

4  または  を押して、【ケーブル タイプ】に移動します。 を押して選択します。

5 現在のケーブルタイプは  で示されます。

音声起動送信

音声起動送信 (VOX) により、プログラムされたチャンネルでハンズフリーの音声通話を開始できます。VOX 対応アクセサリのマイクが音声を検出すると、プログラムされた期間中、無線機は自動的に送信します。



注記:

この機能は、同じ周波数の市民バンドチャンネルでは利用できません。

次のいずれかの方法で、VOX を有効または無効にすることができます。

- 無線機の電源を切り、もう一度電源を入れて VOX を有効にします。
- スクロールアップ/スクロール ダウン ボタンを使用してチャンネルを変更し、VOX を有効にします。
- 音量/チャンネル ノブを使用してチャンネルを変更し、VOX を有効にします。
- プログラムされた [VOX] ボタンを使用して VOX のオンとオフを切り替えるか、メニューを使用して VOX を有効または無効にします。
- 無線機の動作中に PTT ボタンを押すと、VOX は無効になります。







注記:



この機能のオンとオフの切り替えは、この機能に対応している無線機に限られます。詳細については、ディーラーまたはシステム管理者にご確認ください。



音声起動送信のオンとオフの切り替え

下記の手順に従って、無線機で音声起動送信 (VOX) のオンとオフを切り替えます。

- 以下のいずれか 1 つの手順を実行します。
 - プログラムされた [VOX] ボタンを押します。以下の手順をスキップします。
 -  を押してメニューにアクセスします。

-  または  を押して [せってい] に移動します。 を押して選択します。

-  または  を押して [きのうせってい] に移動します。 を押して選択します。

-  または  を押して [VOX] に移動します。 を押して選択します。

-  を押して、[VOX] を有効または無効にします。

**注記:**

通話許可トーンが有効であれば、トリガワードを発生して通話を開始します。通話許可トーンが終了するまで待ち、マイクに向かってはっきりと話します。詳細については、「[通話許可トーンのオンとオフの切り替え ページ 206](#)」を参照してください。

音声ガイドのオンとオフの切り替え

この機能をオンにすると、ユーザーがゾーンとチャンネルを割り当てたときや、ユーザーがプログラム可能ボタンを押したときに、その内容を音声で知らせます。ディスプレイに表示されているコンテンツの読み取りが困難な状況で役立ちます。

この音声インジケータは、お客様の要件に応じてカスタマイズできます。下記の手順に従って、無線機で音声ガイドのオンとオフを切り替えます。

オプションボードのオンとオフの切り替え

各チャンネル内のオプションボード機能をプログラム可能なボタンに割り当てることができます。1つのチャンネルは、最大6のオプションボード機能をサポートします。下記の手

順に従って、無線機でオプションボードのオンとオフを切り替えます。

プログラムされた **[オプションボード]** ボタンを押します。

音声変換

音声変換機能は、ディーラーまたはシステム管理者のみが有効にできます。音声変換が有効になっている場合、音声ガイド機能は自動的に無効になります。音声ガイドが有効になっている場合、音声変換機能が自動的に無効になりません。













この機能では、次の機能を音声で知らせることができます。

- 現在のチャンネル
- 現在のゾーン
- プログラムされたボタン機能のオン/オフ
- 受信済みテキストメッセージの内容
- 受信済みJOBチケットの内容

この音声インジケータは、お客様の要件に応じてカスタマイズできます。本機能は、ディスプレイに表示されているコンテンツの読み取りが困難な状況で役立ちます。

音声変換の設定







下記の手順に従って、音声変換機能を設定します。



- 1  を押してメニューにアクセスします。
- 2  または  を押して【せってい】に移動します。 を押して選択します。
- 3  または  を押して【きのうせってい】に移動します。 を押して選択します。
- 4  または  を押して【おんせいガイド】に移動します。 を押して選択します。
- 5  または  を押して以下の機能のいずれかに移動します。 を押して選択します。
利用可能な機能は以下の通りです。
 - すべて
 - メッセージ

- JOB チケット
 - チャンネル
 - ゾーン
 - プログラム ボタン
- ✓ 選択した設定の隣に  が表示されます。





自動通話転送のオンとオフの切り替え

無線機を設定して、音声通話を別の無線機に自動的に転送できます。

- 1  を押してメニューにアクセスします。
- 2  または  を押して【せってい】に移動します。 を押して選択します。
- 3  または  を押して【きのうせってい】に移動します。 を押して選択します。

4  または  を押して【つうわてんそう】に移動します。  を押して選択します。



5 以下のいずれか 1 つの手順を実行します。



-  または  を押して転送を有効にします。有効にすると、✓が【ゆうこう】の隣に表示されます。
 -  または  を押して転送を無効にします。無効な場合、✓が【ゆうこう】の隣で非表示になります。
-



カメラ メニュー タイマー

ホーム画面に自動的に切り替わるまでメニューが表示され続ける時間を設定できます。下記の手順に従って、メニュータイマーを設定します。



1  を押してメニューにアクセスします。

2  または  を押して【せってい】に移動します。  を押して選択します。

3  または  を押して【きのうせってい】に移動します。  を押して選択します。

4  または  を押して【ひょうじ】に移動します。  を押して選択します。

5  または  を押して【タイマー メニュー】に移動します。  を押して選択します。



6  または  を押して必要な設定に移動します。  を押して選択します。



アナログマイク AGC のオンとオフの切り替え



アナログマイク自動ゲイン制御 (AGC) を使用すると、アナログシステム上で送信するときに、無線機のマイクゲインを自動的に制御できます。

この機能は、大きい音が出ないようにしたり小さい音をプリセット値まで増幅したりして、音声レベルを一定に保ちます。下記の手順に従って、無線機でアナログマイク AGC のオンとオフを切り替えます。

- 1  を押してメニューにアクセスします。

- 2  または  を押して【せってい】に移動します。  を押して選択します。

- 3  または  を押して【きのうせってい】に移動します。  を押して選択します。

- 4  または  を押して【Mic AGC-A】に移動します。  を押して選択します。

- 5  を押して、アナログマイク AGC を有効または無効にします。

ディスプレイに次のいずれかの結果が表示されます。



- 有効にすると、✓が【ゆうこう】の隣に表示されます。
- 無効な場合、✓が【ゆうこう】の隣で非表示になります。



デジタルマイク AGC のオンとオフの切り替え



デジタルマイク自動ゲイン制御 (AGC) を使用すると、デジタルシステム上で送信するときに、無線機のマイクゲインを自動的に制御できます。

この機能は、大きい音が出ないようにしたり小さい音をプリセット値まで増幅したりして、音声レベルを一定に保ちます。下記の手順に従って、無線機でデジタルマイク AGC のオンとオフを切り替えます。

- 1  を押してメニューにアクセスします。

2  または  を押して【せってい】に移動します。  を押して選択します。

3  または  を押して【きのうせってい】に移動します。  を押して選択します。

4  または  を押して【Mic AGC-D】に移動します。  を押して選択します。

5  を押して、デジタルマイク AGC を有効化/無効化します。

ディスプレイに次のいずれかの結果が表示されます。

- 有効にすると、✓が【ゆうこう】の隣に表示されます。
 - 無効な場合、✓が【ゆうこう】の隣で非表示になります。
-

インテリジェント オーディオのオンとオフの切り替え



定常騒音源と非定常騒音源の両方を含む、周辺環境の背景雑音が多い場合、それに負けないように音量を自動的に調整します。これは受信側の限定機能であり、送信音声は影響を受けません。下記の手順に従って、無線機でインテリジェント オーディオのオンとオフを切り替えます。









注記:

この機能は、Bluetooth セッションでは使用できません。









- 以下のいずれか 1 つの手順を実行します。
 - プログラムされた【インテリジェント オーディオ】ボタンを押します。以下の手順をスキップします。
 -  を押してメニューにアクセスします。
-

- 2  または  を押して【せってい】に移動します。  を押して選択します。
-

3  または  を押して【きのうせってい】に移動します。  を押して選択します。

4  または  を押して【Int オーディオ】に移動します。  を押して選択します。



5 以下のいずれか 1 つの手順を実行します。



-  または  を押して【オン】に移動します。  を押して選択します。ディスプレイで  が【オン】の隣に表示されます。
 -  または  を押して【オフ】に移動します。  を押して選択します。ディスプレイで  が【オフ】の隣に表示されます。
-



ハウリング抑制機能のオンとオフの切り替え

この機能により、受信コールでのハウリング抑制機能を最小限に抑えることができます。下記の手順に従って、ハウリング抑制機能のオンとオフを切り替えます。





1  を押してメニューにアクセスします。

2  または  を押して【せってい】に移動します。  を押して選択します。]

3  または  を押して【きのうせってい】に移動します。  を押して選択します。

4  または  を押して【ハウリング よくせい】に移動します。  を押して選択します。



5 以下のいずれか 1 つの手順を実行します。



-  を押してハウリング抑制機能を有効にします。有効にすると、  が【ゆうこう】の隣に表示されます。
 -  を押してハウリング抑制機能を無効にします。無効な場合、  が【ゆうこう】の隣で非表示になります。
-



トリル拡張のオンとオフの切り替え

歯茎でのトリル音 (転がるような "R") の単語を多用する言語で話しているとき、この機能を有効にできます。下記の手順に従って、無線機でトリル拡張のオンとオフを切り替えます。









- 以下のいずれか 1 つの手順を実行します。
 - プログラムされた **【トリル拡張】** ボタンを押します。以下の手順をスキップします。
 -  を押してメニューにアクセスします。

-  または  を押して **【せってい】** に移動します。 を押して選択します。

-  または  を押して **【きのうせってい】** に移動します。 を押して選択します。

-  または  を押して **【トリル かくちょう】** に移動します。 を押して選択します。

- 以下のいずれか 1 つの手順を実行します。

-  または  を押して **【オン】** に移動します。 を押して選択します。ディスプレイで  が **【オン】** の隣に表示されます。
-  または  を押して **【オフ】** に移動します。 を押して選択します。ディスプレイで  が **【オフ】** の隣に表示されます。

音声アンビエンス

環境に応じて、無線機の音声アンビエンスをカスタマイズできます。

デフォルト

これはデフォルト設定です。

だいおんりょう













この設定は、ノイズ抑制を有効にしてスピーカの音量を上げ、周囲の騒音が大きい環境でも使用できるようにします。

ワークグループ

この設定は、ハウリング抑制を有効にして **AGC** を無効にし、複数の無線機が相互に近い場所であっても使用できるようにします。

音声アンビエンスの設定

下記の手順に従って、お使いの環境に応じて無線機で音声アンビエンスを設定します。

- 1  を押してメニューにアクセスします。
- 2  または  を押して【せってい】に移動します。 を押して選択します。
- 3  または  を押して【きのうせってい】に移動します。 を押して選択します。
- 4  または  を押して【オンセイ アンビエンス】に移動します。 を押して選択します。
- 5  または  を押して必要な設定に移動します。 を押して選択します。
設定は次のとおりです。
 - 工場出荷時の設定にするには【しょきち】を選択します。

- 【だいおんりょう】を選択し、騒音環境下でスピーカの音量を上げます。
- 【ワーク グループ】を選択し、複数の無線機が相互に近い場所にあるときのハウリングを緩和します。

選択した設定の横に  が表示されます。

音声プロフィール

優先度に応じて、無線機の音声プロフィールをカスタマイズできます。

デフォルト

これはデフォルト設定です。













レベル 1、レベル 2、およびレベル 3

40代、50代、60代以上の成人には、一般的にノイズで誘発される難聴がありますが、これらの設定は、この難聴の特性に応じて音声を補正します。

トレブルブースト、ミッドブースト、およびバスブースト
これらの設定は、金属的な細い音声、鼻声、深い音声などに対応しています。

音声プロファイルの設定

下記の手順に従って、無線機で音声プロファイルを設定します。

- 1  を押してメニューにアクセスします。
- 2  または  を押して【せってい】に移動します。 を押して選択します。
- 3  または  を押して【きのうせってい】に移動します。 を押して選択します。
- 4  または  を押して【オンセイ プロファイル】に移動します。 を押して選択します。
- 5  または  を押して必要な設定に移動します。 を押して選択します。
設定は次のとおりです。

- 【しょきち】を選択して先に選択されていた音声プロファイルを無効にし、工場出荷時の設定に戻ります。
- 40 代以上の成人でみられる騒音性難聴を補正するための音声プロファイルを【レベル 1】、【レベル 2】、または【レベル 3】から選択します。
- 甲高い声、鼻にかかった声、深い声など、お好みに応じて音声プロファイルを【トレブル ブースト】、【ミッド ブースト】、または【バス ブースト】から選択します。

選択した設定の横に  が表示されます。

グローバル ナビゲーション サテライト システム (GNSS) のオンとオフの切り替え

グローバル ナビゲーション サテライト システム (GNSS) は、無線機の正確な位置を測定する衛星ナビゲーションシ



システムです。**GNSS**には、グローバルポジショニングシステム (**GPS**) と北斗衛星導航システム (**BDS**) が含まれます。



**注記:**



選択した無線機のモデルが **GPS** および **BDS** を備えていることがあります。**GNSS** で使用する衛星群は **CPS** を使用して構成されています。無線機がどのようにプログラムされているかについては、ディーラーまたはシステム管理者に確認してください。

1 下記のいずれかの手順に従って、無線機で **GNSS** をオンまたはオフに切り替えます。

- プログラムされた **[GNSS]** ボタンを押します。
-  を押してメニューにアクセスします。次の手順に進みます。

2  または  を押して **【せってい】** に移動します。 を押して選択します。

3  または  を押して **【きのうせってい】** に移動します。 を押して選択します。

4  または  を押して **[GNSS]** に移動します。
 を押して選択します。

5  を押して **GNSS** を有効または無効にします。
有効にすると、✓が**【ゆうこう】**の隣に表示されません。
無効な場合、✓が**【ゆうこう】**の隣で非表示になります。



フレックス **RX** リスト



フレックス **RX** リストは、受信グループリストのメンバーの作成と割り当てができる機能です。お使いの無線機は、このリストに含まれる **16** 名まで対応できます。(この機能は **Capacity Plus** ではサポートされません。)



フレックス RX リストのオンとオフの切り替え

下記の手順に従って、フレックス RX リストのオンとオフを切り替えます。

- 1 以下のいずれか 1 つの手順を実行します。
 - プログラムされた【フレックス RX リスト】ボタンを押します。以下の手順をスキップします。
 -  を押してメニューにアクセスします。

- 2  または  を押して【フレックス RX リスト】に移動します。  を押して選択します。

- 3 以下のいずれか 1 つの手順を実行します。
 -  または  を押して【オン】に移動します。  を押して選択します。ポジティブ インジケータ トーンが鳴ります。ディスプレイにポジティブ ミニ通知が表示されます。

-  または  を押して【オフ】に移動します。  を押して選択します。ネガティブ インジケータ トーンが鳴ります。ディスプレイにネガティブ ミニ通知が表示されます。

一般無線機情報



無線機には、一般的のパラメータに関する様々な情報が含まれています。

無線機の一般情報は以下のとおりです。

- 無線エイリアスと ID
- ファームウェアとコードプラグの各バージョン
- ソフトウェア更新
- GNSS 情報
- サイト情報







注記:



 を押して前の画面に戻ります。ホーム画面に戻るには、 を長押しします。無線機は、無操作タイマーの終了後に、現在の画面を終了します。



無線エリアスと ID のチェック

下記の手順に従って、無線機で無線エリアスと ID をチェックします。

- 1 以下のいずれか 1 つの手順を実行します。
 - プログラムされた **[無線エリアスと ID]** ボタンを押します。以下の手順をスキップします。ポジティブ インジケータ トーンが鳴ります。プログラムされた **[無線エリアスと ID]** ボタンを押して、前の画面に戻ることができます。
 -  を押してメニューにアクセスします。

- 2  または  を押して **[せってい]** に移動します。 を押して選択します。

- 3  または  を押して **[きき じょうほう]** に移動します。 を押して選択します。

- 4  または  を押して **[ID]** に移動します。



 を押して選択します。



テキスト行の 1 行目に、無線エリアスが表示されます。テキスト行の 2 行目に、無線機 ID が表示されます。



ファームウェアとコードプラグのバージョンチェック

下記の手順に従って、無線機でファームウェアとコードプラグの各バージョンをチェックします。

- 1  を押してメニューにアクセスします。







- 2  または  を押して **[せってい]** に移動します。 を押して選択します。



- 3  または  を押して **[きき じょうほう]** に移動します。 を押して選択します。

- 4  または  を押して【バージョン】に移動します。  を押して選択します。
- ディスプレイに現在のファームウェアとコードプラグの各バージョンが表示されます。

ソフトウェア更新情報のチェック

この機能は、OTAP または Wi-Fi を通じて実行された最新のソフトウェア更新の日付と時間を表示します。下記の手順に従って、無線機でソフトウェア更新情報をチェックします。

- 1  を押してメニューにアクセスします。
- 2  または  を押して【せってい】に移動します。  を押して選択します。
- 3  または  を押して【きき じょうほう】に移動します。  を押して選択します。

- 4  または  を押して【ソフト アップデート】に移動します。  を押して選択します。
- ディスプレイに最新のソフトウェア更新の日付と時刻が表示されます。







ソフトウェア更新メニューは、少なくとも 1 回の OTAP または Wi-Fi セッションが正常に完了した後でのみ利用できるようになります。詳細については、「[エア接続プログラミング ページ 488](#)」を参照してください。

GNSS 情報の確認

無線機の GNSS 情報を表示します。











- 緯度
- 経度
- 高度
- 方向
- 速度
- HDOP
- 衛星

• バージョン

- 1  を押してメニューにアクセスします。
- 2  または  を押して【せってい】に移動します。  を押して選択します。
- 3  または  を押して【きき じょうほう】に移動します。  を押して選択します。
- 4  または  を押して【GNSS じょうほう】に移動します。  を押して選択します。
- 5  または  を押して、必要な項目に移動します。  を押して選択します。 要求した GNSS 情報がディスプレイに表示されます。

サイト情報の表示

下記の手順に従って、無線機がある現在のサイト名を表示します。



- 1  を押してメニューにアクセスします。
- 2  または  を押して【せってい】に移動します。  を押して選択します。
- 3  または  を押して【きき じょうほう】に移動します。  を押して選択します。
- 4  または  を押して【サイトじょうほう】に移動します。  を押して選択します。



ディスプレイに現在のサイト名が表示されます。

エンタープライズ Wi-Fi 証明書の詳細の表示



選択したエンタープライズ Wi-Fi 証明書の詳細を表示することができます。

- 1  を押してメニューにアクセスします。

2  または  を押して『せってい』に移動します。 を押して選択します。

3  または  を押して『証明書メニュー』に移動します。 を押して選択します。

✓ 準備が完了した証明書の横に表示されます。

4  または  を押して必要な証明書に移動します。 を押して選択します。

無線機に、証明書の完全な詳細が表示されます。



注記:

準備が完了していない証明書については、ステータスのみ表示されます。

認可されたアクセサリ リスト

Motorola Solutions では、お使いの無線機の生産性を向上させるアクセサリのリストをご用意しています。

アンテナ

- 一体型 GNSS (GPS/Galileo/QZSS/GLONASS)、UHF、403 ~ 527MHz、2.0dB ゲイン、スルーホール実装、BNC (HAE6017_)
- GPS/UHF 一体型、470 ~ 527MHz、1/4 WAVE、スルーホール実装、BNC (HAE6018_)
- UHF、403 ~ 527MHz、2.0 dB ゲイン、スルーホール実装、BNC (HAE6021_)
- GPS/UHF 一体型、494 ~ 512MHz、3.0 dB ゲイン、スルーホール実装、BNC (HAE6023_)
- GPS/UHF 一体型、470 ~ 494MHz、3.0dB ゲイン、スルーホール実装、BNC (HAE6025_)
- 800/900、806 ~ 941MHz、スタビィー、スルーホール実装、ミニ U (HAF4013_)
- 800/900、806 ~ 941MHz、1/4 WAVE、スルーホール実装、ミニ U (HAF4025_)
- 800/900、806 ~ 941MHz、3dB ゲイン、スルーホール実装、ミニ U (HAF4026_)
- 800/900、806 ~ 941MHz、5.0dB ゲイン、スルーホール実装、ミニ U (HAF4027_)
- GPS+RF 一体型、806 ~ 941MHz、1/4 WAVE、スルーホール実装、ミニ U (HAF4029_)
- GPS+RF 一体型、806 ~ 941MHz、3.0dB ゲイン、スルーホール実装、ミニ U (HAF4030_)
- GPS+RF 一体型、806 ~ 941MHz、5.0dB ゲイン、スルーホール実装、ミニ U (HAF4032_)
- GPS+RF 一体型、806 ~ 941MHz、5.0dB ゲイン、スルーホール実装、ミニ U (HAF4033_)
- UHF、300 ~ 340MHz、1/4 WAVE、スルーホール実装、BNC (PMAD4140_)
- GPS/GNSS/UHF 一体型、350 ~ 400MHz、1/4 WAVE、スルーホール実装、BNC (PMAD4102_)
- UHF、350 ~ 400MHz、1/4 Wave、スルーホール実装、BNC (PMAD4107_)
- UHF、320 ~ 360MHz、1/4 WAVE、スルーホール実装、BNC (PMAD4141_)

- 一体型 GNSS (GPS/Galileo/QZSS/GLONASS)、UHF、300 ~ 340MHz、1/4 WAVE、スルーホール実装、BNC (PMAD4142_)
- 一体型 GNSS (GPS/Galileo/QZSS/GLONASS)、UHF、320 ~ 360MHz、1/4 WAVE、スルーホール実装、BNC (PMAD4143_)
- 一体型 GNSS (GPS/Galileo/QZSS/GLONASS)、UHF、403 ~ 430MHz、1/4 WAVE、スルーホール実装、BNC (PMAE4035_)
- 一体型 GNSS (GPS/Galileo/QZSS/GLONASS)、UHF、406 ~ 420MHz、3.5 dB ゲイン、スルーホール実装、BNC (PMAE4036_)
- 一体型 GNSS (GPS/Galileo/QZSS/GLONASS)、UHF、450 ~ 470MHz、1/4 WAVE、スルーホール実装、BNC (PMAE4037_)
- 一体型 GNSS (GPS/Galileo/QZSS/GLONASS)、UHF、450 ~ 470MHz、5dB ゲイン、スルーホール実装、BNC (PMAE4038_)
- 固定式 GPS アクティブ アンテナ (PMAN4000_)
- ウィンドウ貼付型 GPS アクティブ アンテナ (PMAN4001_)
- 磁石固定型 GPS アクティブ アンテナ (PMAN4002_)
- 一体型 GNSS (GPS/Galileo/QZSS/BeiDou-2)、NMO 実装ベース、BNC (PMAN4003_)
- VHF、136 ~ 144MHz、1/4 WAVE、スルーホール実装、BNC (RAD4198_)
- VHF、146 ~ 150.8MHz、1/4 WAVE、スルーホール実装、BNC (RAD4199_)
- VHF、150.8 ~ 162MHz、1/4 WAVE、スルーホール実装、BNC (RAD4200_)
- VHF、162 ~ 174MHz、1/4 WAVE、スルーホール実装、BNC (RAD4201_)
- 一体型 GNSS (GPS/Galileo/QZSS/GLONASS)、VHF、136 ~ 144MHz、1/4 WAVE、スルーホール実装、BNC (RAD4219_)
- 一体型 GNSS (GPS/Galileo/QZSS/GLONASS)、VHF、146 ~ 150.8MHz、1/4 WAVE、スルーホール実装、BNC (RAD4220_)
- 一体型 GNSS (GPS/Galileo/QZSS/GLONASS)、VHF、150.8 ~ 162MHz、1/4 WAVE、スルーホール実装、BNC (RAD4221_)
- 一体型 GNSS (GPS/Galileo/QZSS/GLONASS)、VHF、162 ~ 174MHz、1/4 WAVE、スルーホール実装、BNC (RAD4222_)

- UHF、403 ~ 430MHz、1/4 WAVE、スルーホール実装、BNC (RAE4151_)
- UHF、450 ~ 470MHz、1/4 WAVE、スルーホール実装、BNC (RAE4152_)
- UHF、450 ~ 470MHz、5.0 dB ゲイン、スルーホール実装、BNC (RAE4154_)
- UHF、406 ~ 420MHz、3.5 dB ゲイン、スルーホール実装、BNC (RAE4158_)
- UHF、450 ~ 470MHz、5.0dB ゲイン (PMAE4043_)
- VHF、162 ~ 174MHz、1/4 WAVE (RAD4223_)
- VHF、150.8 ~ 162MHz、1/4 WAVE (RAD4224_)
- VHF、146 ~ 150.8MHz、1/4 WAVE (RAD4225_)
- VHF、136 ~ 144MHz、1/4 WAVE (RAD4226_)
- VHF、146 ~ 172MHz、3.0dB ゲイン (RAD4227_)

ベース **PMAN4003_** と組み合わせて使用する場合のみ:

- UHF、494 ~ 512MHz、3.0dB ゲイン、スルーホール実装 (HAE6027_)
- UHF、470 ~ 494MHz、3.0dB ゲイン、スルーホール実装 (HAE6028_)
- UHF、403 ~ 527MHz、2.0dB ゲイン、スルーホール実装 (HAE6029_) (標準アンテナベースでも使用可)
- UHF、470 ~ 527MHz、1/4 WAVE、スルーホール実装 (HAE6030_)
- UHF、403 ~ 430MHz、1/4 WAVE (PMAE4039_)
- UHF、450 ~ 470MHz、1/4 WAVE (PMAE4041_)
- UHF、406 ~ 420MHz、3.5dB ゲイン (PMAE4040_)
- UHF、450 ~ 470MHz、3.5dB ゲイン (PMAE4042_)

オーディオ アクセサリ

- 米国プラグ付き HK200 Bluetooth ヘッドセット (89409N)
- 英国プラグ付き HK200 Bluetooth ヘッドセット (ASMHK200VP-GB2A)
- ユーロプラグ付き HK200 Bluetooth ヘッドセット (ASMHK200-GB3A)
- 韓国プラグ付き HK200 Bluetooth ヘッドセット (ASMHK200-KR2A)
- 中国プラグ付き HK200 Bluetooth ヘッドセット (ASMHK200-CN2A)
- 豪州プラグ付き HK200 Bluetooth ヘッドセット (ASMHK200-AU2A)
- 電話スタイルのハンドセット (HMN4098_)

- オペレーション クリティカル ワイヤレス イヤピース、**12 インチ ケーブル (NNTN8125_)**
- オペレーション クリティカル ワイヤレス イヤピース、**9.5 インチ ケーブル (NNTN8126_)**
- オペレーション クリティカル ワイヤレス PTT Pod (NNTN8127_)
- 非セキュア ワイヤレス ヘッドセットと、プッシュトゥトーク音声、**12 インチ ケーブル付きプッシュトゥトーク デバイス (NNTN8189_)**
- **Bluetooth アクセサリ キット、SP、9.5 インチ ケーブル (NNTN8190_)**
- **2 線式イヤホン 2 セット (白黒各 1 セット)、シングルワイヤイヤホン (黒)、市販のヘッドホン用 3.5mm アダプタを含むワイヤレス ステルス キット (NNTN8296_)**¹⁴
- 着用が目立たないキット用ワイヤレス ネックループ Y 字型アダプタおよび保持フック (NNTN8385_)¹⁶
- ビジネス ワイヤレス アクセサリ キット (PMLN6463_)
- ワイヤレス **R2.17A** ロングレンジ リモート スピーカマイク (PMMN4095_)
- ワイヤレス **R2.17** モバイル マイク ゲートウェイ (PMMN4097_)
- **ブーム マイク付きフレキシブルフィット スイベル式イヤピース (PMLN7181_)**¹⁶
- **ブーム マイク付きフレキシブルフィット スイベル式イヤピース、マルチパック (PMLN7203_)**¹⁶
- **着用が目立たないイヤピース キット (RLN4922_)**¹⁶
- **XBT ネットバンド型、非セキュア ワイヤレス ヘビー デューティ ヘッドセット (RLN6490_)**
- **XBT オーバーヘッド、非セキュア ワイヤレス ヘビー デューティ ヘッドセット (RLN6491_)**
- **Bluetooth アクセサリ キット ポッド用インライン マイク付きスイベル式イヤピース、3 個パック (RLN6550_)**¹⁶
- **デスクトップ マイク (RMN5050_)**
- **コンパクト マイク (RMN5052_)**
- **IMPRES 4 ウェイ ナビゲーション キーボード マイク (RMN5127_)**
- **音声向上機能付きヘビー デューティ マイク (RMN5053_)**
- **音声向上機能付きバイザ マイク (RMN5054_)**

¹⁴ お使いの無線機は上記のアクセサリと互換性があります。詳細についてはディーラーにお問い合わせください。

ケーブル

- コンパクト マイク交換ケーブル (3075336B07)
- ヘビー デューティ/キーボード マイク交換ケーブル (3075336B10)
- バッテリと接続する電源ケーブル、10 フィート (3 メートル) ケーブル、15 アンペア (1 ~ 25 ワット) (HKN4137_)
- バッテリと接続する電源ケーブル、10 フィート (3 メートル) ケーブル、20 アンペア (1 ~ 45 ワット) (HKN4191_)
- バッテリと接続する電源ケーブル、20 フィート (6 メートル) ケーブル、20 アンペア (1 ~ 45 ワット) (HKN4192_)
- モバイル前部 (MMP) プログラミング ケーブル (HKN6184_)
- MAP プログラミング ケーブル (PMKN4010_)
- MAP プログラミングおよびテスト ケーブル (PMKN4016_)
- 移動無線機およびリピータの背面アクセサリ コネクタ ユニバーサル ケーブル (PMKN4018_)
- モバイル マイク延長ケーブル、10 フィート (PMKN4033_)

- モバイル マイク延長ケーブル、20 フィート (PMKN4034_)
- リモート マウント (3 メートル) ケーブル (PMKN4143_)
- リモート マウント (5 メートル) ケーブル (PMKN4144_)
- イグニッション感知ケーブル (RKN4136_)

デスクトップ アクセサリ

- US 電源コード (3060665A04)
- GPN6145 用無線機電源ケーブル (GKN6266_)
- スピーカなしデスクトップトレイ (GLN7318_)
- モード切り替え電源 (1 ~ 25 ワット モデル) (CE マーク付き) (GPN6145_)
- 電源とケーブル (HPN4007_)
- 電源 14 ボルト 15 アンペア UNI 117/240 VAC、UK プラグ (HPN4011_)
- 電源 14 ボルト 15 アンペア UNI 117/240 VAC、US プラグ (HPN4007_)
- 背面アクセサリ コネクタ用ハードウェア キット (PMLN5072_)
- スピーカ付きデスクトップトレイ (RSN4005_)

取り付けキット

- 画面プロテクタ、クリア (1 ユニット入りシングルパック) (AY000269A01_) ¹⁵
- インダッシュ (DIN) 取り付けキット (RLN6465_)
- ロープロファイルトラニオンキット (RLN6466_)
- ハイプロファイルトラニオンキット (RLN6467_)
- キーロックトラニオンキット (RLN6468_)
- ロープロファイルトラニオン - バッグ (RLN6469_)
- リモートマウントトランシーバインタフェース (PMLN6402_)
- リモートマウントコントロールヘッドインタフェース (PMLN6403_)

その他のアクセサリ

- 過電流プロテクタ、タワーマウントキット (DQT1)
- 過電流プロテクタ、同軸バルクヘッド (DSISB50LNC2MA)
- PL259/Mini-U アンテナアダプタ、8 フィート (2.4 メートル) ケーブル (HKN9557_)

- マイクハングアップクリップ (すべてのマイク) (HLN9073_)
- 汎用マイクハングアップクリップ (すべてのマイク) (HLN9414_)
- IMPRES モバイル MMP ノン PC アダプタ (PMKN4072_)
- IMPRES モバイル MAP ノン PC アダプタ (PMKN4070_)
- 汎用オプションボード (PMLN5718_S)
- 透明チューブ付きオペレーションクリティカルワイヤレス 1 線式監視キット (PMLN7052_) ¹⁶
- プッシュボタン PTT (RLN5926_)
- 緊急フットスイッチ (RLN5929_)

スピーカ

- 13 ワット外部スピーカ (RSN4002_)
- 7.5 ワット外部スピーカ (RSN4003_)
- 5 ワット外部スピーカ (RSN4004_)

¹⁵ お使いの無線機は上記のアクセサリと互換性があります。詳細についてはディーラーにお問い合わせください。

¹⁶ お使いの無線機は上記のアクセサリと互換性があります。詳細についてはディーラーにお問い合わせください。

목차

중요 안전 정보.....	23
소프트웨어 버전.....	24
저작권.....	25
컴퓨터 소프트웨어 저작권.....	27
취급 주의 사항.....	28
장 1: 기본 작동법.....	29
무전기 전원 켜기.....	29
무전기 전원 끄기.....	29
볼륨 조절.....	29
장 2: 무전기 컨트롤.....	31
볼륨/채널 노브.....	31
이중 노브 작동 기본 설정 지정.....	32
키패드 마이크 버튼.....	33
장 3: WAVE.....	35
WAVE OnCloud/OnPremise.....	35
무전기 모드에서 WAVE 모드로 전환.....	35
WAVE 그룹 호출.....	36
WAVE 그룹 호출 수신 및 응답.....	36
WAVE 개별 호출 수신 및 응답.....	37

WAVE 모드에서 무전기 모드로 전환.....	37
WAVE Tactical/5000.....	38
활성 WAVE 채널 설정.....	38
WAVE 채널 정보 보기.....	38
WAVE 끝점 정보 보기.....	38
WAVE 구성 변경.....	39
WAVE 그룹 호출.....	40
파트 I: Capacity Max 작업.....	41
PTT(Push-To-Talk) 버튼.....	41
프로그래밍 가능 버튼.....	41
지정 가능한 무전기 기능.....	41
지정 가능한 설정 또는 유틸리티 기능.....	43
프로그래밍된 기능에 액세스.....	44
상태 표시기.....	44
아이콘.....	45
LED 표시등.....	51
신호음.....	51
가청음.....	52
상태 표시음.....	52
등록.....	52
존 및 채널 선택.....	53

존 선택.....	53	프로그래밍 가능 숫자 키로 브로	
별칭 검색을 사용하여 존 선택.....	54	드캐스트 호출 전송.....	65
호출 유형 선택.....	55	브로드캐스트 호출 수신.....	65
사이트 선택.....	55	개별 호출.....	66
로밍 요청.....	55	개별 호출 전송.....	66
사이트 잠금 켜기/끄기.....	56	프로그래밍 가능 숫자 키를 사용	
사이트 제한.....	56	하여 개별 호출 전송	67
사이트 트렁킹.....	56	별칭 검색을 사용하여 개별 호출	
호출.....	57	전송	67
그룹 호출.....	58	윈터치 호출 버튼으로 개별 호출	
그룹 호출 전송.....	58	전송.....	69
연락처 목록을 사용하여 그룹 호		매뉴얼 다이얼을 사용하여 개별	
출 전송.....	59	호출 전송	70
프로그래밍 가능 숫자 키를 사용		개별 호출 수신.....	71
하여 그룹 호출 전송	60	개별 호출 수락하기.....	71
별칭 검색을 사용하여 그룹 호출		개별 호출 거부하기.....	72
전송	60	전체 호출.....	72
그룹 호출에 응답.....	62	전체 호출 전송.....	72
브로드캐스트 호출.....	63	프로그래밍 가능 숫자 키를 사용	
브로드캐스트 호출 전송.....	63	하여 전체 호출 전송	73
연락처 목록을 사용하여 브로드		별칭 검색을 사용하여 전체 호출	
캐스트 호출 전송.....	64	전송.....	74
		전체 호출 수신.....	75

전화 통화.....	76	수신 그룹 목록.....	91
전화 송신.....	76	우선순위 모니터링.....	92
프로그래밍 가능 버튼을 사용하여		통화 그룹의 우선 순위 편집.....	92
여 전화 송신 	77	여러 개의 통화 그룹 가입.....	93
연락처 목록을 사용하여 전화 송		통화 그룹 가입 추가.....	93
신	79	통화 그룹 가입 제거.....	94
별칭 검색을 사용하여 전화 송신..	81	Talkback	95
매뉴얼 다이얼을 사용하여 전화		Bluetooth	96
송신.....	83	블루투스 켜기 및 끄기.....	96
이중 신호음 다중 주파수(DTMF)..	86	블루투스 장치에 연결.....	97
DTMF 호출 시작.....	86	검색 가능 모드에서 블루투스 장	
전체 호출로 전화 통화에 응답.....	86	치에 연결.....	98
그룹 호출로 전화 통화에 응답.....	86	블루투스 장치 연결 해제.....	99
개별 호출로 전화 통화에 응답.....	87	무전기 내부 스피커와 블루투스	
호출 선점.....	88	장치 간에 오디오 라우팅 전환.....	99
음성 중단.....	88	장치 세부 항목 보기.....	100
음성 중단 활성화.....	88	장치 이름 삭제.....	100
고급 기능.....	89	Bluetooth 마이크 게인.....	101
호출 대기열.....	89	실내 위치.....	101
우선 순위 통화.....	89	실내 위치 켜기 또는 끄기.....	101
통화 그룹 스캔.....	90	실내 위치 비콘 정보에 액세스....	103
통화 그룹 스캔 켜기 또는 끄기.....	90	멀티 사이트 컨트롤.....	103

수동 사이트 검색 시작.....	103	호출 경보용 호출음 활성화 또는 비활성화.....	113
사이트 잠금 켜기/끄기.....	103	선택 호출용 호출음 활성화 또는 비활성화.....	113
인접 사이트 목록에 액세스.....	104	문자 텔레메트리 상태용 호출음 활성화 또는 비활성화.....	114
홈 채널 미리 알림.....	104	벨 스타일 지정.....	115
홈 채널 미리 알림 음소거.....	104	알람음 볼륨 높이기.....	115
새 홈 채널 설정.....	105	호출 목록 기능.....	116
원격 모니터링.....	105	최근 호출 목록 보기.....	116
원격 모니터 시작.....	105	호출 목록의 별칭 또는 ID 저장...	116
연락처 목록을 사용하여 원격 모니터 시작	106	호출 목록에서 호출 삭제.....	117
매뉴얼 다이얼을 사용하여 원격 모니터 시작.....	107	호출 목록에서 전체 호출 삭제....	118
연락처 설정.....	108	호출 목록에서 세부 항목 보기....	118
프로그래밍 가능 숫자 키에 항목 할당.....	108	호출 경보 작동.....	119
항목과 프로그래밍 가능 숫자 키의 관계 제거.....	109	호출 경보 전송.....	120
새 연락처 추가.....	110	연락처 목록을 사용하여 호출 경보 전송.....	120
호출 표시 설정.....	111	호출 경보에 응답.....	120
개별 호출용 호출음 활성화 또는 비활성화.....	111	음소거 모드.....	121
문자 메시지용 호출음 활성화 또는 비활성화.....	112	음소거 모드 켜기.....	121
		음소거 모드 타이머 설정.....	122

음소거 모드 종료.....	122	문자 메시지 보기.....	137
비상 작동.....	123	텔레메트리 상태 문제 메 시지 보기.....	137
비상 알람 전송.....	124	문자 메시지에 응답.....	138
비상 알람 및 호출 전송.....	125	단축 문자를 사용하여 문 자 메시지에 회신.....	138
비상 알람 후 음성 알림 전송.....	126	문자 메시지 재전송.....	139
비상 알람 수신.....	127	문자 메시지 전달.....	140
비상 알람에 응답	128	매뉴얼 다이얼을 사용하 여 문자 메시지 전달.....	141
호출 포함 비상 알람에 응답.....	129	문자 메시지 편집.....	141
상태 메시지.....	130	문자 메시지 작성.....	142
상태 메시지 전송.....	130	문자 메시지 전송.....	143
프로그래밍 가능 버튼을 사용하 여 상태 메시지 전송.....	131	수신 문자함의 문자 메시 지 삭제.....	144
연락처 목록을 사용하여 상태 메 시지 전송.....	132	수신 문자함의 모든 문자 메시지 삭제.....	144
매뉴얼 다이얼을 사용하여 상태 메 시지 전송.....	133	전송한 문자 메시지.....	145
상태 메시지 보기.....	133	전송한 문자 메시지 보기.....	146
상태 메시지에 응답.....	134	전송한 문자 메시지 전송.....	146
상태 메시지 삭제.....	135	보낸 문자함 폴더에서 전 송한 문자 메시지 삭제.....	147
모든 상태 메시지 삭제.....	136		
문자 메시지.....	136		
문자 메시지.....	136		

보낸 문자함 폴더에서 전 송한 모든 문자 메시지 삭 제.....	147	원격 서버의 로그인 또는 로그아웃.....	160
저장된 문자 메시지.....	148	작업 티켓 작성.....	160
저장된 문자 메시지 보기.....	148	작업 티켓에 응답.....	161
저장된 문자 메시지 편집.....	149	하나의 작업 티켓 템플릿을 사용 하여 작업 티켓 전송.....	162
임시 보관함 폴더에 저장 된 문자 메시지 삭제.....	150	둘 이상의 작업 티켓 템플릿을 사 용하여 작업 티켓 전송.....	162
단축 문자 메시지	150	작업 티켓 삭제.....	163
단축 문자 메시지 전송	150	모든 작업 티켓 삭제.....	164
텍스트 입력 구성.....	151	개인 정보 보호.....	164
단어교정 기능 활성화 또는 비활 성화.....	152	프라이버시 기능 켜기 또는 끄기.....	165
단어 예측 활성화 또는 비활성화.....	152	응답 금지.....	166
대문자.....	153	응답 금지 켜기 또는 끄기.....	166
사용자 지정 단어 보기.....	154	사용 중지/복구.....	166
사용자 지정 단어 편집.....	154	무전기 사용 중지.....	167
사용자 지정 단어 추가.....	156	연락처 목록을 사용하여 무전기 사용 중지.....	167
사용자 지정 단어 삭제.....	157	매뉴얼 다이얼을 사용하여 무전 기 사용 중지.....	168
사용자 지정 단어 전체 삭제.....	158	무전기 복구.....	169
작업 티켓.....	158	연락처 목록을 사용하여 무전기 복구.....	169
작업 티켓 폴더에 액세스.....	159		

매뉴얼 다이얼을 사용하여 무선 기 복구.....	170	지정된 무선기를 사용하여 원격 으로 Wi-Fi 켜기 또는 끄기(개별 제어).....	179
무선 연결 끊김.....	171	지정된 무선기를 사용하여 원격 으로 Wi-Fi 켜기 또는 끄기(그룹 제어).....	180
단독 작업자.....	171	네트워크 액세스 포인트에 연결.	180
비밀번호 잠금 기능.....	172	Wi-Fi 연결 상태 확인.....	182
비밀번호를 사용하여 무선기에 액세스.....	172	네트워크 목록 새로 고침.....	182
잠금 상태에서 무선기 잠금 해제	173	네트워크 추가.....	183
비밀번호 잠금 켜기 또는 끄기....	173	네트워크 액세스 포인트의 세부 항목 보기.....	183
비밀번호 변경.....	174	네트워크 액세스 포인트 제거.....	184
알림 목록.....	175	동적 그룹 번호 할당(DGNA).....	185
알림 목록에 액세스.....	175	DGNA 호출.....	186
OTAP(무선 프로그래밍).....	175	비-DGNA 호출.....	186
타사 주변 기기 연결 모드 선택.....	176	DGNA 호출 수신 및 응답.....	186
수신 신호 강도 표시기.....	177	공공설비.....	187
RSSI 값 보기.....	177	전력 레벨.....	187
전면 패널 구성.....	177	전력 레벨 설정.....	187
전면 패널 구성 모드 들어가기....	177	무전기 신호음/경보 켜기 또는 끄기.....	188
FPP 모드 매개변수 편집.....	177	키패드 톤 켜기 또는 끄기.....	189
Wi-Fi 작동.....	178		
Wi-Fi 켜기 또는 끄기.....	178		

신호음/경보 볼륨 오프셋 레벨 설정.....	189
통화 허용 신호음 켜기 또는 끄기.....	190
전원 켜짐 신호음 켜기 또는 끄기.....	191
문자 메시지 경보음 설정.....	191
디스플레이 모드 변경.....	192
디스플레이 선명도 조절.....	193
흔/라이트 켜기 또는 끄기.....	193
LED 표시등 켜기 또는 끄기.....	194
공용 주소 시스템 켜기 또는 끄기.....	195
외부 공용 주소 시스템 켜기 또는 끄기..	195
홈 화면 켜기 또는 끄기.....	196
언어 설정.....	197
케이블 타입 식별.....	197
음성 안내 켜기 또는 끄기.....	198
옵션 보드 켜기 또는 끄기.....	198
TTS.....	198
TTS 설정.....	198
메뉴 타이머 설정.....	199
디지털 마이크 AGC 켜기 또는 끄기.....	200
지능형 오디오 켜기 또는 끄기.....	200
음향 피드백 억제기 기능 켜기 또는 끄기.....	201

트릴 강화 켜기 또는 끄기.....	202
오디오 환경.....	203
오디오 환경 설정.....	203
오디오 프로필.....	204
오디오 프로필 설정.....	204
GNSS 켜기 또는 끄기.....	205
일반 무전기 정보.....	205
무전기 별칭 및 ID 확인.....	206
펌웨어 및 코드플러그 버전 확인	206
소프트웨어 업데이트 정보 확인.	207
GNSS 정보 확인.....	207
사이트 정보 표시.....	208
기업 Wi-Fi 인증서 세부 정보 보기.....	209
파트 II: Connect Plus 작동.....	210
Connect Plus 모드의 추가 무전기 컨트롤.....	210
PTT(Push-To-Talk) 버튼.....	210
프로그래밍 가능 버튼.....	210
지정 가능한 무전기 기능.....	210
지정 가능한 설정 또는 유틸리티 기능.....	212
Connect Plus 모드에서 상태 표시 식별	212
디스플레이 아이콘.....	213



















호출 아이콘.....	215	인바운드 개인 전화에서 버퍼링된 오버다이얼 사 용.....	224
고급 메뉴 아이콘.....	216	인바운드 개인 전화에서 라이브 오버다이얼 사용..	225
보낸 문자함 아이콘.....	216	인바운드 전화 통화 그룹 호출 수 신.....	225
Bluetooth 장치 아이콘.....	217	인바운드 전화 다중 그룹 호출...	225
LED 표시등.....	217	무전기 호출 송신.....	225
상태 표시음.....	218	채널 선택 노브를 사용하여 호출 전송.....	226
경보음.....	218	그룹 호출 전송.....	226
Connect Plus 모드와 비Connect Plus		개별 호출 전송.....	227
모드 간 전환.....	219	사이트 전체 호출 전송....	227
Connect Plus 모드에서 호출 전송 및 수신.....	219	다중 그룹 호출 전송.....	228
사이트 선택.....	219	원터치 호출 버튼으로 개별 호출 전송.....	228
로밍 요청.....	219	프로그래밍 가능 매뉴얼 다이얼 버튼으로 호출 전송.....	229
사이트 잠금 켜기/끄기.....	220	개별 호출 전송.....	229
사이트 제한.....	220	프로그래밍 가능한 매뉴얼 다이 얼 버튼으로 아웃바운드 개인 전 화 송신.....	230
존 선택.....	220		
다중 네트워크 사용.....	221		
호출 유형 선택.....	221		
무전기 호출 수신 및 응답.....	222		
그룹 호출 수신 및 응답.....	222		
개별 호출 수신 및 응답.....	223		
사이트 전체 호출 수신.....	223		
인바운드 개인 전화 수신.....	224		













전화 메뉴를 통해 아웃바운드 개 인 전화 송신.....	230	스캔 중 발신 응답.....	239
연락처에서 아웃바운드 개인 전 화 송신.....	231	사용자 구성 스캔.....	240
아웃바운드 개인 전화에서 채널 허가 대기.....	232	스캔 켜기 또는 끄기.....	240
연결된 아웃바운드 개인 전화에 서 버퍼링된 오버다이얼 사용.....	233	스캔 목록 편집.....	241
연결된 아웃바운드 개인 전화에 서 라이브 오버다이얼 사용.....	234	멤버 추가 메뉴를 통해 그룹 추가 또는 삭제.....	242
Connect Plus 모드의 고급 기능.....	234	스캔 작업 이해.....	244
홈 채널 미리 알림.....	234	토크백 스캔.....	244
자동 폴백.....	235	통화 그룹의 우선 순위 편집.....	245
자동 폴백 모드 표시.....	235	연락처 설정.....	246
폴백 모드에서 호출 전송/수신....	235	연락처에서 개별 호출 전송.....	246
정상 작동 복구.....	236	별칭 검색으로 호출 전송.....	247
무전기 점검.....	236	새 연락처 추가.....	248
무전기 점검 전송.....	236	호출 표시 설정.....	248
원격 모니터링.....	237	호출 경보용 호출음 활성화 또는 비활성화.....	248
원격 모니터 시작.....	237	개별 호출음 활성화 및 비활성화	249
스캔.....	239	문자 메시지용 호출음 활성화 및 비활성화.....	250
스캔 시작 또는 중지.....	239	벨 경보 유형 선택.....	251
		알람음 볼륨 높이기.....	251
		호출 목록.....	251











최근 호출 목록 보기.....	251	비상 경보 시작.....	261
호출 목록에서 호출 삭제.....	252	비상 모드 종료.....	262
호출 목록에서 세부 항목 보기....	252	문자 메시지.....	262
호출 경보 작동.....	253	단축 문자 메시지 전송.....	263
호출 경보에 응답.....	253	원터치 액세스 버튼을 사용하여 단축 문자 메시지 전송.....	263
연락처 목록에서 호출 경보 전송	254	임시보관함 폴더에 액세스.....	264
원터치 액세스 버튼으로 호출 경 보 전송.....	254	저장된 문자 메시지 보기.	264
음소거 모드.....	255	저장된 문자 메시지 편집 및 전송.....	265
음소거 모드 켜기.....	255	임시보관함에 저장된 문 자 메시지 삭제.....	266
음소거 모드 타이머 설정.....	255	전송 실패 문자 메시지 관리.....	266
음소거 모드 종료.....	256	문자 메시지 재전송.....	266
비상 작동.....	257	문자 메시지 전달.....	267
들어오는 비상 수신.....	258	전송한 문자 메시지 관리.....	267
알람 목록에 비상 세부 정보 저장	258	전송한 문자 메시지 보기.	267
비상 세부 정보 삭제.....	259	전송한 문자 메시지 전송.	268
비상 호출에 응답.....	259	보낸 문자함에서 전송한 모든 문자 메시지 삭제.....	269
비상 경보에 응답.....	260	문자 메시지 수신.....	270
비상 복원 호출 무시.....	260	문자 메시지 읽기.....	271
비상 호출 시작.....	260		
지시 음성 포함 비상 호출 시작...261			







수신된 문자 메시지 관리.....	271	장치 세부 항목 보기.....	283
수신 문자함의 문자 메시지 보기.....	271	장치 이름 삭제.....	284
수신 문자함의 문자 메시지 회신.....	272	Bluetooth 마이크 개인.....	284
수신 문자함의 문자 메시지 삭제.....	273	실내 위치.....	285
수신 문자함의 모든 문자 메시지 삭제.....	274	실내 위치 켜기 또는 끄기.....	285
개인 정보 보호.....	274	실내 위치 비콘 정보에 액세스....	286
프라이버시 활성화(스크램블링된) 호출 전송.....	276	알림 목록.....	287
보안.....	276	알림 목록에 액세스.....	287
무전기 비활성화.....	276	Wi-Fi 작동.....	287
무전기 복구.....	278	Wi-Fi 켜기 또는 끄기.....	288
Bluetooth 작동.....	280	지정된 무전기를 사용하여 원격으로 Wi-Fi 켜기 또는 끄기(개별 제어).....	289
블루투스 켜기 및 끄기.....	280	지정된 무전기를 사용하여 원격으로 Wi-Fi 켜기 또는 끄기(그룹 제어).....	289
Bluetooth 장치 찾기 및 연결.....	281	네트워크 액세스 포인트에 연결.....	290
Bluetooth 장치 찾기 및 연결(검색 가능 모드).....	282	Wi-Fi 연결 상태 확인.....	291
Bluetooth 장치 연결 해제.....	282	네트워크 목록 새로 고침.....	292
무전기 내부 스피커와 블루투스 장치 간에 오디오 라우팅 전환....	283	네트워크 추가.....	292
		네트워크 액세스 포인트의 세부 항목 보기.....	293

네트워크 액세스 포인트 제거.....	294	음향 피드백 억제기 기능 켜기 또는 끄기.....	306
공공설비.....	295	GNSS 켜기 또는 끄기.....	307
무전기 톤/경보 켜기 또는 끄기... 295		일반 무전기 정보 액세스.....	308
톤/경보 최소 볼륨 레벨 설정.....	295	무전기 모델 번호 색인 확인.....	308
통화 허용 경보음 켜기 또는 끄기.....	296	옵션 보드 OTA 코드플러그 파일의 CRC 확인.....	309
출력 증강 경보음 켜기 및 끄기... 297		사이트 ID(사이트 번호) 표시.....	309
전원 레벨 설정.....	297	사이트 정보 확인.....	310
디스플레이 모드 변경.....	298	무전기 ID 확인.....	310
디스플레이 선명도 조절.....	299	펌웨어 버전 및 코드플러그 버전 확인.....	311
홈 화면 켜기 또는 끄기.....	300	업데이트 확인.....	312
언어.....	300	기업 Wi-Fi 인증서 세부 정보 보기.....	319
LED 표시 켜기 또는 끄기.....	301	파트 III: 기타 시스템.....	321
케이블 타입 식별.....	301	PTT(Push-To-Talk) 버튼.....	321
음성 안내.....	302	프로그래밍 가능 버튼.....	321
메뉴 타이머.....	302	지정 가능한 무전기 기능.....	321
혼/라이트 켜기 또는 끄기.....	303	지정 가능한 설정 또는 유틸리티 기능... 324	
이중 노브 작동 기본 설정 지정... 304		프로그래밍된 기능에 액세스.....	325
디지털 마이크 AGC(마이크 AGC-D).....	304		
지능형 오디오.....	305		

상태 표시기.....	325	그룹 호출에 응답.....	341
아이콘.....	326	개별 호출 	342
LED 표시.....	332	개별 호출 전송 	342
신호음.....	333	연락처 목록을 사용하여 개별 호 출 전송 	343
상태 표시음.....	333	매뉴얼 다이얼을 사용하여 개별 호출 전송 	344
가청음.....	334	프로그래밍 가능 숫자 키를 사용 하여 개별 호출 전송  	345
컨벤셔널 아날로그 및 디지털 모드.....	334	개별 호출에 응답 	345
아이콘 정보.....	334	전체 호출.....	346
IP Site Connect 	335	전체 호출 수신.....	346
Capacity Plus--단일 사이트 	335	전체 호출 전송.....	347
Capacity Plus 다중 사이트 	336	프로그래밍 가능 숫자 키를 사용 하여 전체 호출 전송 	347
존 및 채널 선택.....	336	선택 호출 	348
존 선택.....	337	선택 호출 송신.....	348
별칭 검색을 사용하여 존 선택.....	337	선택 호출에 응답 	349
채널 선택.....	338	전화 통화 	349
호출.....	338	전화 송신 	350
그룹 호출.....	339	연락처 목록을 사용하여 전화 송 신 	351
그룹 호출 전송.....	339		
연락처 목록을 사용하여 그룹 호 출 전송.....	340		
프로그래밍 가능 숫자 키를 사용 하여 그룹 호출 전송  	340		

매뉴얼 다이얼을 사용하여 전화 송신 	353	브로드캐스트 음성 호출 수신.....	363
별칭 검색을 사용하여 그룹 호출, 개별 호출, 전화 호출 또는 전체 호출 전송  	355	주소 미지정 호출.....	364
이중 신호음 다중 주파수(DTMF) 357		주소 미지정 호출.....	364
DTMF 호출 시작.....	357	주소 미지정 호출에 응답.....	365
그룹 호출로 전화 통화에 응답 		개방 음성 채널 모드(OVCM).....	365
.....	357	OVCM 호출.....	366
전체 호출로 전화 통화에 응답 		OVCM 호출에 응답.....	366
.....	358	고급 기능.....	367
개별 호출로 전화 통화에 응답 		홈 채널 미리 알림.....	367
.....	359	홈 채널 미리 알림 음소거.....	367
무전기 호출 중지 	359	새 홈 채널 설정.....	367
토크어라운드.....	360	무전기 점검 	368
중계기 및 토크어라운드 모드 전환.....	360	무전기 점검 전송 	368
브로드캐스트 음성 호출.....	361	매뉴얼 다이얼을 사용하여 무전기 점검 전송 	369
브로드캐스트 음성 호출.....	361	원격 모니터링.....	370
프로그래밍 가능 숫자 키를 사용한 브로드캐스트 음성 호출  ...	361	원격 모니터 시작.....	370
별칭 검색을 사용한 브로드캐스트 음성 호출 	362	연락처 목록을 사용하여 원격 모니터 시작	371
		매뉴얼 다이얼을 사용하여 원격 모니터 시작 	372
		스캔 목록.....	374

스캔 목록의 항목 보기.....	374	항목과 프로그래밍 가능 숫자 키 의 관계 제거 	384
별칭 검색을 사용하여 스캔 목록 의 항목 보기	374	새 연락처 추가.....	385
스캔 목록에 새 항목 추가.....	375	기본 연락처 설정 	386
별칭 검색을 사용하여 스캔 목록 에 새 항목 추가 	376	호출 표시 설정.....	386
스캔 목록에서 항목 삭제.....	377	호출 경보용 호출음 활성화 또는 비활성화.....	386
스캔 목록에서 항목 우선 순위 설 정.....	378	개별 호출용 호출음 활성화 또는 비활성화 	387
스캔.....	379	선택 호출용 호출음 활성화 또는 비활성화 	388
스캔 켜기 또는 끄기.....	379	문자 메시지용 호출음 활성화 또 는 비활성화 	389
스캔 중 전송 응답.....	380	문자 텔리메트리 상태용 호출음 활성화 또는 비활성화.....	389
방해 채널 삭제.....	380	벨 스타일 지정.....	390
방해 채널 복원.....	381	알람음 볼륨 높이기.....	391
보트 스캔 	381	호출 목록 기능.....	391
연락처 설정.....	381	최근 호출 목록 보기.....	391
연락처 목록을 사용하여 그룹 호 출 전송.....	382	호출 목록에서 호출 삭제 	392
연락처 목록을 사용하여 개별 호 출 전송 	382	호출 목록 세부 항목 보기 	392
프로그래밍 가능 숫자 키에 항목 할당 	383		

호출 목록의 별칭 또는 ID 저장 	393	비상 모드 재시작.....	404
호출 정보 작동.....	394	비상 알람 전송 후 비상 모드 종 료.....	404
호출 정보 전송.....	394	알람 목록에서 알람 항목 삭제....	404
연락처 목록을 사용하여 호출 경 보 전송.....	394	문자 메시지.....	405
매뉴얼 다이얼을 사용하여 호출 정보 전송.....	395	문자 메시지 	405
호출 정보에 응답.....	395	문자 메시지 보기.....	405
음소거 모드.....	396	텔레메트리 상태 문제 메 시지 보기.....	406
음소거 모드 켜기.....	396	문자 메시지에 응답 	406
음소거 모드 타이머 설정.....	397	단축 문자를 사용하여 문 자 메시지에 회신 	407
음소거 모드 종료.....	397	문자 메시지 재전송.....	408
비상 작동.....	398	문자 메시지 전달 	408
비상 알람 수신.....	398	매뉴얼 다이얼을 사용하 여 문자 메시지 전달  ...	409
비상 알람에 응답.....	399	문자 메시지 편집.....	410
비상 알람 수신 후 비상 모드 종 료.....	400	문자 메시지 작성.....	411
비상 알람 전송.....	400	문자 메시지 전송.....	411
비상 알람 및 호출 전송.....	401	수신 문자함의 문자 메시 지 삭제.....	412
비상 알람 후 음성 알림.....	402		
비상 알람 후 음성 알림 전송 	403		

수신 문자함의 모든 문자 메시지 삭제 ④	413	대문자.....	422
전송한 문자 메시지 ④	414	사용자 지정 단어 보기.....	423
전송한 문자 메시지 보기 ④	414	사용자 지정 단어 편집.....	423
전송한 문자 메시지 전송 ④	415	사용자 지정 단어 추가.....	425
보낸 문자함 폴더에서 전 송한 문자 메시지 삭제 ④	416	사용자 지정 단어 삭제.....	426
보낸 문자함 폴더에서 전 송한 모든 문자 메시지 삭 제.....	416	사용자 지정 단어 전체 삭제.....	426
저장된 문자 메시지.....	417	작업 티켓.....	427
저장된 문자 메시지 보기.	417	작업 티켓 폴더에 액세스.....	428
저장된 문자 메시지 편집.	418	원격 서버의 로그인 또는 로그아웃.....	429
임시 보관함 폴더에 저장 된 문자 메시지 삭제.....	418	작업 티켓 작성.....	429
단축 문자 메시지 ④	419	작업 티켓에 응답.....	429
단축 문자 메시지 전송 ④	419	하나의 작업 티켓 템플릿을 사용 하여 작업 티켓 전송.....	430
텍스트 입력 구성.....	420	둘 이상의 작업 티켓 템플릿을 사 용하여 작업 티켓 전송.....	431
단어교정 기능 활성화 또는 비활 성화.....	421	작업 티켓 삭제.....	431
단어 예측 활성화 또는 비활성화	421	모든 작업 티켓 삭제.....	432
		개인 정보 보호 ④	433
		프라이버시 기능 켜기 또는 끄기 ④	434
		응답 금지.....	435

응답 금지 켜기 또는 끄기.....	435	블루투스 장치 연결 해제.....	446
멀티 사이트 컨트롤.....	435	무전기 내부 스피커와 블루투스 장치 간에 오디오 라우팅 전환....	447
수동 사이트 검색 시작.....	435	장치 세부 항목 보기.....	447
사이트 잠금 켜기/끄기.....	436	장치 이름 삭제.....	447
인접 사이트 목록에 액세스.....	436	Bluetooth 마이크 개인.....	448
보안 ●.....	436	실내 위치.....	448
무전기 비활성화 ●.....	437	실내 위치 켜기 또는 끄기.....	449
연락처 목록을 사용하여 무전기 비활성화 ●.....	438	실내 위치 비콘 정보에 액세스....	450
매뉴얼 다이얼을 사용하여 무전 기 비활성화 ●.....	439	알림 목록.....	450
무전기 활성화 ●.....	440	알림 목록에 액세스.....	451
연락처 목록을 사용하여 무전기 활성화 ●.....	440	ARTS ●.....	451
매뉴얼 다이얼을 사용하여 무전 기 활성화 ●.....	441	OTAP (무선 프로그래밍) ●.....	451
단독 작업자.....	443	송신 금지.....	452
Bluetooth	443	송신 금지 활성화.....	452
블루투스 켜기 및 끄기.....	444	송신 금지 비활성화.....	453
블루투스 장치에 연결.....	444	타사 주변 기기 연결 모드 선택.....	453
검색 가능 모드에서 블루투스 장 치에 연결.....	445	수신 신호 강도 표시기.....	454
		RSSI 값 보기.....	454
		비밀번호 잠금 기능.....	454
		비밀번호를 사용하여 무전기에 액세스.....	454

잠금 상태에서 무전기 잠금 해제	455	스켈치 레벨.....	465
비밀번호 잠금 켜기 또는 끄기....	455	스켈치 레벨 설정.....	465
비밀번호 변경.....	456	전력 레벨.....	466
전면 패널 구성.....	457	전력 레벨 설정.....	466
전면 패널 구성 모드 들어가기....	457	무전기 신호음/경보 켜기 또는 끄기.....	467
FPP 모드 매개변수 편집.....	457	키패드 톤 켜기 또는 끄기.....	468
Wi-Fi 작동.....	458	신호음/경보 볼륨 오프셋 레벨 설정.....	468
Wi-Fi 켜기 또는 끄기.....	458	통화 허용 신호음 켜기 또는 끄기.....	469
지정된 무전기를 사용하여 원격		전원 켜짐 신호음 켜기 또는 끄기.....	470
으로 Wi-Fi 켜기 또는 끄기(개별		문자 메시지 경보음 설정.....	470
제어).....	459	디스플레이 모드 변경.....	471
지정된 무전기를 사용하여 원격		디스플레이 선명도 조절.....	472
으로 Wi-Fi 켜기 또는 끄기(그룹		혼/라이트 켜기 또는 끄기.....	472
제어).....	460	LED 표시등 켜기 또는 끄기.....	473
네트워크 액세스 포인트에 연결.	460	공용 주소 시스템 켜기 또는 끄기.....	473
Wi-Fi 연결 상태 확인.....	461	외부 공용 주소 시스템 켜기 또는 끄기..	474
네트워크 목록 새로 고침.....	462	홈 화면 켜기 또는 끄기.....	475
네트워크 추가.....	462	언어 설정.....	475
네트워크 액세스 포인트의 세부		케이블 타입 식별.....	476
항목 보기.....	463	음성 활성화 송신.....	476
네트워크 액세스 포인트 제거....	464	음성 활성화 전송 켜기 또는 끄기	
공공설비.....	465	477

음성 안내 켜기 또는 끄기.....478

옵션 보드 켜기 또는 끄기.....478

TTS..... 478

 TTS 설정..... 478

자동 호출 전달 켜기 또는 끄기.....479

메뉴 타이머 설정.....480

아날로그 마이크 AGC 켜기 또는 끄기.. 480

디지털 마이크 AGC 켜기 또는 끄기.....481

지능형 오디오 켜기 또는 끄기.....482

음향 피드백 억제기 기능 켜기 또는 끄기..... 482

트릴 강화 켜기 또는 끄기.....483

오디오 환경.....484

 오디오 환경 설정.....484

오디오 프로필..... 485

 오디오 프로필 설정..... 485

GNSS 켜기 또는 끄기..... 486

유연한 수신 목록  486

 유연한 수신 목록 켜기 또는 끄기..... 487

일반 무전기 정보.....487

 무전기 별칭 및 ID 확인.....487

 펌웨어 및 코드플러그 버전 확인 488

 소프트웨어 업데이트 정보 확인.489

 GNSS 정보 확인..... 489

 사이트 정보 표시.....490

 기업 Wi-Fi 인증서 세부 정보 보기.....490

파트 IV: 승인된 액세스러 목록..... 492

중요 안전 정보

모바일 양방향 무선기에 대한 RF 에너지 노출 및 제품 안전 설명서

주의!

본 무선기는 업무 목적으로만 사용하도록 제한되어 있습니다. 무선기를 사용하기 전에 안전한 사용, RF 에너지에 대한 이해 및 관련 표준과 규정을 준수하는 제어와 관련된 중요한 작동 지침이 수록된 모바일 양방향 무선기에 대한 RF 에너지 노출 및 제품 안전 설명서를 읽어주시기 바랍니다.

Motorola Solutions 공인 안테나 및 기타 액세서리 목록을 보시려면 다음 웹 사이트를 방문하십시오.

<http://www.motorolasolutions.com>

태국에서 사용되는 모델의 경우:

อุปกรณ์โทรคมนาคมนี้ได้ปฏิบัติตามข้อกำหนดของคณะกรรมการกิจการ

โทรคมนาคมแห่งชาติ

이 통신 장비는 National Telecommunications Commission의 요건을 따릅니다.

소프트웨어 버전

다음 단원에 설명된 모든 기능은 소프트웨어 버전

R02.10.00.0000 이상에서 지원됩니다.

무전기의 소프트웨어 버전을 확인하려면 [펌웨어 및 코드플러그 버전 확인 페이지](#)의 **206** 부분을 참조하십시오.

자세한 내용은 대리점이나 시스템 관리자에게 문의하십시오.

저작권

이 문서에 설명되어 있는 **Motorola Solutions** 제품에는 저작권 보호를 받는 **Motorola Solutions** 컴퓨터 프로그램이 포함되어 있을 수 있습니다. 미국과 기타 국가의 법률은 저작권 보호를 받는 컴퓨터 프로그램에 대한 독점적인 권리를 **Motorola Solutions**에게 부여합니다. 따라서 본 문서에 수록된 **Motorola Solutions** 제품에 포함되어 있으며 **Motorola Solutions**이 저작권을 보유한 모든 컴퓨터 프로그램은 **Motorola Solutions**의 서면 승인이 없는 한 어떠한 형식으로도 복사 또는 복제할 수 없습니다.

© 2019 Motorola Solutions, Inc. All Rights Reserved

이 문서의 어떤 부분도 **Motorola Solutions, Inc.**의 사전 서면 허가 없이는 어떤 형태나 방식으로든 검색 시스템에 복사, 전송, 저장하거나 다른 언어나 컴퓨터 언어로 번역할 수 없습니다.

또한 제품 판매 관련 법규에 의해 사용이 허가된 일반적인 비배타적, 사용료가 면제된 라이선스를 제외하고는 **Motorola Solutions** 제품의 구매를 통해 저작권, 특허 또는 **Motorola Solutions** 특허 출원하의 어떠한 라이선스도 직접적, 암시적, 금반언 또는 그 밖의 어떤 형식으로도든 권리를 부여받은 것으로 간주되지 않습니다.

면책고지

본 문서에 수록된 일부 기능, 설비 및 능력은 특정 시스템용으로 적용하거나 라이선스가 부여될 수 없으며 특정 가입자 장치의 특성 또는 일부 매개변수의 구성에 따라 달라질 수 있습니다. 자세한 정보는 현지 **Motorola Solutions** 대리점에 문의하십시오.

등록 상표

MOTOROLA, MOTO, MOTOROLA SOLUTIONS 및 양식화된 **M** 로고는 **Motorola Trademark Holdings, LLC**의 상표 또는 등록 상표이며 라이선스에 의거하여 사용됩니다. 기타 모든 상표는 해당 소유자의 재산입니다.

유럽 연합(EU) 전기 전자 폐기물 지침(WEEE: Waste Electrical and Electronic Equipment)



■ 유럽 연합의 WEEE 규정에 의하면 유럽 연합에서 판매되는 제품(또는 포장)에는 가위표가 표시된 휴지통 라벨이 부착되어 있어야 합니다.

WEEE 규정에 따라, 가위표가 표시된 휴지통 라벨이 부착되어 있으면 유럽 연합의 고객과 최종 사용자는 전기 전자 장비 또는 부속품을 생활 쓰레기로 폐기해서는 안 됩니다.

유럽 연합의 고객 또는 최종 사용자는 현지 장비 공급업체 대리점이나 서비스 센터에 연락해 해당 국가의 쓰레기 수거 시스템에 대한 정보를 참조해야 합니다.

컴퓨터 소프트웨어 저작권

본 설명서에 설명된 **Motorola Solutions** 제품에는 반도체 메모리 또는 기타 매체에 저장되어 있으며 저작권 보호를 받는 **Motorola Solutions** 컴퓨터 프로그램이 포함될 수 있습니다. 미국과 기타 국가의 법률은 **Motorola Solutions**에 저작권 보호를 받는 컴퓨터 프로그램에 대한 독점적인 권리를 부여하며, 여기에는 저작권 보호를 받는 컴퓨터 프로그램을 어떠한 형태로든 복사하거나 복제하는 행위도 포함됩니다. 따라서 **Motorola Solutions**의 명시적인 서면 승인 없이는 이 설명서에 수록된 **Motorola Solutions** 제품에 포함되며 저작권 보호를 받는 모든 컴퓨터 프로그램을 어떤 방식으로든 복사, 복제, 수정, 리버스 엔지니어링 및 배포할 수 없습니다. 또한, **Motorola Solutions** 제품의 구매는 직접적으로, 묵시적으로, 금반언 원칙에 의해 또는 기타 어떠한 방식으로든 **Motorola Solutions**의 저작권, 특허권 또는 특허 출원에 대한 라이선스 (제품 판매 시 법에 의해 제공되는 일반적이고 비독점적인 라이선스 제외)를 부여하는 것으로 간주될 수 없습니다.

이 제품에 내장된 **AMBE+2™** 음성 코딩 기술은 **Digital Voice Systems, Inc.**의 특허권, 저작권 및 거래 기밀 사항을 비롯하여 지적 재산권에 의해 보호를 받습니다.

음성 코딩 기술의 사용은 이 통신 장비용으로만 허가되었습니다. 이 기술의 사용자가 개체 코드를 디컴파일, 리버스 엔지니어링 또는 디어셈블링하는 행위나 그 밖의 방법으로

개체 코드를 인간 판독 가능 형태로 변환하는 행위는 명시적으로 금지되어 있습니다.

미국 특허 번호: #5,870,405, #5,826,222, #5,754,974, #5,701,390, #5,715,365, #5,649,050, #5,630,011, #5,581,656, #5,517,511, #5,491,772, #5,247,579, #5,226,084 및 #5,195,166.

취급 주의 사항

MOTOTRBO 시리즈 디지털 휴대용 무전기는 IP67 사양을 충족하여, 무전기가 침수되는 등의 불리한 현장 조건을 견딜 수 있습니다. 이 섹션에서는 몇 가지 기본 취급 주의사항에 대해 설명합니다.



주의:

무전기를 분해하지 마십시오. 무전기 밀봉 부위가 손상되어 무전기에 누출이 생길 수 있습니다. 무전기 유지관리는 무전기를 테스트하고 봉합 부위를 교체할 장비를 갖춘 서비스 센터에서만 이루어져야 합니다.

- 무전기가 침수된 경우, 무전기를 잘 흔들어 스피커 그릴과 마이크 포트 내부에 들어간 물을 모두 제거합니다. 물이 들어가면 오디오 성능이 떨어질 수 있습니다.
- 무전기의 배터리 접촉부가 물에 닿은 경우, 배터리 접촉부와 무전기를 모두 닦고 말린 후 배터리를 무전기에 넣으십시오. 남아 있는 물기로 인해 무전기에 누전이 발생할 수 있습니다.
- 무전기가 부식성 물질(바닷물 등)에 잠긴 경우, 무전기와 배터리를 깨끗한 물로 행군 다음 건조시킵니다.
- 무전기의 외부 표면을 세척하려면 순한 주방 세제와 깨끗한 물을 섞어 묽게 만든 용액으로 씻으십시오(예: 물 3.8리터에 세제 1티스푼을 섞음).
- 배터리 접촉부 아래에 있는 무전기 새시 통풍구(구멍)를 절대로 찌르지 마십시오. 이 통풍구는 무전기 균압이 이루어지게 합니다. 그렇게 하면 무전기에 물이 들어갈 수 있는 경로가 생겨 무전기의 방수 기능이 상실될 수 있습니다.
- 통풍구는 절대 라벨로도 막거나 덮으면 안 됩니다.
- 통풍구에는 기름기가 많은 물질이 접촉되지 않도록 하십시오.
- 안테나가 올바르게 장착된 무전기는 수심 최고 1m(3.28피트), 최고 침수 시간 30분까지 방수가 되도록 설계되었습니다. 최대 한계를 초과하거나 안테나 없이 사용하면 무전기가 손상될 수 있습니다.
- 무전기를 닦을 때에는 고압 제트 스프레이를 무전기에 사용하지 마십시오. 그렇게 하면 1m 깊이의 압력이 초과되며 물이 무전기에 스며들 수 있습니다.

기본 작동법

이 장에서는 무전기 사용을 시작할 수 있도록 작동법을 설명합니다.

무전기 전원 켜기

다음 절차에 따라 무전기 전원을 켭니다.

켜기/끄기 버튼을 누릅니다.

성공 시:

- 신호음이 울립니다.
- 녹색 LED가 켜집니다.
- 디스플레이에 MOTOTRBO (TM)이 표시된 다음 시작 메시지가 또는 시작 이미지가 표시됩니다.
- 홈 화면이 표시됩니다.

신호음/경보 기능이 비활성화된 경우 전원을 켤 때 신호음이 들리지 않습니다.

무전기 전원이 켜지지 않으면 배터리를 확인하십시오. 배터리가 충전되어 있으며 제대로 장착되었는지 확인하십시오. 무전기 전원이 계속 켜지지 않으면 대리점에 문의하십시오.

무전기 전원 끄기

다음 절차에 따라 무전기 전원을 끕니다.

켜기/끄기 버튼을 길게 누릅니다.

무전기가 완전히 꺼지는 데 최대 7초까지 걸릴 수 있습니다.

디스플레이에 전원 끄는 중이 표시됩니다.

볼륨 조절

다음 절차에 따라 무전기의 볼륨 레벨을 변경합니다.

다음 중 하나를 수행합니다.

- 볼륨을 높이려면 **켜기/끄기/볼륨 조절 노브**를 시계 방향으로 돌립니다.
- 볼륨을 낮추려면 **켜기/끄기/볼륨 조절 노브**를 반시계 방향으로 돌립니다.



주의:

최소 볼륨 오프셋을 가지도록 무전기를 프로그래밍할 수 있습니다. 그러면 볼륨을 프로그래밍된 최소 볼륨 아래로 낮출 수 없습니다. 자세한 내용은 대리점이나 시스템 관리자에게 문의하십시오.

무전기 컨트롤

이 장에서는 무전기를 제어하는 버튼 및 기능을 설명합니다.

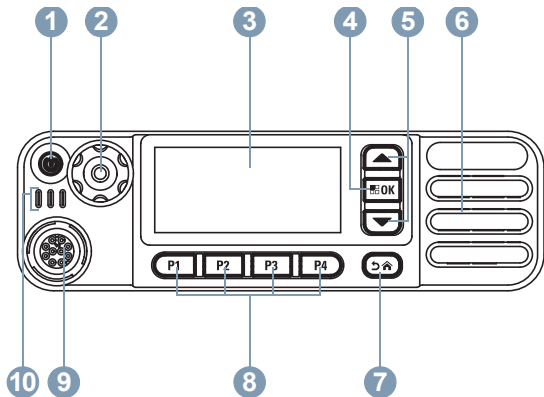

- 1 켜기/끄기/정보 버튼
- 2 볼륨/채널 노브
- 3 디스플레이
- 4 메뉴/확인 버튼
- 5 위로 스크롤/아래로 스크롤 버튼
- 6 스피커
- 7 되돌아가기/홈 버튼

- 8 전면 프로그래밍 가능 버튼
- 9 액세서리 커넥터
- 10 LED 표시

볼륨/채널 노브

볼륨/채널 노브는 볼륨 및 채널을 컨트롤하도록 프로그래밍할 수도 있고, 볼륨만 컨트롤하도록 프로그래밍할 수도 있습니다.

음량을 조절하려면 **볼륨 조절 페이지의 29**을 참조하십시오.



채널을 변경하려면 채널 선택 상태가 표시될 때까지 **볼륨/채널 노브**를 길게 누릅니다. **볼륨/채널 노브**를 돌려 채널을 선택합니다. 다음 중 하나를 수행하여 채널 선택 상태를 종료합니다.



- **볼륨/채널 노브**를 누릅니다.
- **OK** 를 누릅니다.
- **↶↷** 를 누릅니다.
- 메뉴 타이머가 만료될 때까지 기다립니다.



이중 노브 작동 기본 설정 지정

다음 절차에 따라 무전기에서 이중 노브 작동 기본 설정을 지정합니다.



1  버튼을 눌러 메뉴로 이동합니다.

2  또는  버튼을 눌러 유틸리티로 이동합니다.  버튼을 눌러 선택합니다.

3  또는  버튼을 눌러 무전기 설정으로 이동합니다.  버튼을 눌러 선택합니다.

4  또는  버튼을 눌러 이중 노브로 이동합니다.  버튼을 눌러 선택합니다.

디스플레이에 볼륨 전용과 볼륨 및 채널이 표시됩니다.











5  또는  버튼을 눌러 원하는 설정으로 이동합니다.  버튼을 눌러 선택합니다.

선택한 설정 옆에 ✓이 나타납니다. 화면이 이전 메뉴로 돌아갑니다.

키패드 마이크 버튼

4방향 탐색 키패드 마이크(Motorola Solutions 제품 번호: RMN5127_)의 3x4 영숫자 키패드를 사용하여 무전기 기능에 액세스할 수 있습니다. 문자 많은 경우 키를 여러 번 눌러야 합니다. 표에 필요한 문자를 생성하기 위해 키를 눌러야 하는 횟수가 나와 있습니다.

키	키 누름 횟수												
	1	2	3	4	5	6	7	8	9	10	11	12	13
① .,?	1	.	,	?	!	@	&	'	%	—	:	*	#
② ABC	A	B	C	2									
③ DEF	D	E	F	3									
④ GHI	G	H	I	4									
⑤ JKL	J	K	L	5									

키	키 누름 횟수												
	1	2	3	4	5	6	7	8	9	10	11	12	13
 MNO 6	M	N	O	6									
 7 PQRS	P	Q	R	S	7								
 8 TUV	T	U	V	8									
 WXYZ 9	W	X	Y	Z	9								
 0	0		주의: "0"을 입력하려면 한 번 누르고 CAPS Lock 을 활성화하려면 길게 누릅니다. 다시 한 번 길게 누르면 CAPS Lock 이 꺼집니다.										
 * <	* 또는 Del		주의: 문자 입력 중에 누르면 해당 문자가 삭제됩니다. 숫자 입력 중에 누르면 "*"가 입력됩니다.										
 # &#	# 또는 공백		주의: 문자 입력 중에 누르면 공백이 삽입됩니다. 숫자 입력 중에 누르면 "#"이 입력됩니다.										

WAVE

광역 음성 환경(WAVE™)은 두 대 이상의 무전기 간의 호출을 가능하게 하는 새로운 방법을 제공합니다.

WAVE를 사용하면 서로 다른 네트워크 장치 간에 Wi-Fi를 사용해 통신할 수 있습니다. WAVE 호출은 무전기가 Wi-Fi를 통해 IP 네트워크에 연결할 때 이루어집니다.

무전기는 다음과 같은 여러 시스템 구성을 지원합니다.

- WAVE OnCloud/OnPremise
- WAVE Tactical/5000

WAVE 호출을 시작하는 방법은 각 시스템 유형에 따라 다릅니다. 무전기의 시스템 구성에 따라 적절한 단원을 참조하십시오.

표 1: WAVE 디스플레이 아이콘

WAVE가 활성화되면 디스플레이에 다음 아이콘이 잠깐 나타납니다.



WAVE 연결됨
WAVE가 연결되었습니다.







WAVE 연결 해제됨
WAVE가 연결 해제되었습니다.



주의:
이 기능은 특정 모델에만 적용됩니다.

WAVE OnCloud/OnPremise

무전기 모드에서 WAVE 모드로 전환

- 1 다음 중 하나를 수행합니다.
 - 프로그래밍된 **WAVE** 버튼을 누릅니다. 다음 단계를 건너뛸니다.
 -  버튼을 눌러 메뉴로 이동합니다.
- 2  또는  버튼을 눌러 WAVE로 이동합니다.  버튼을 눌러 선택합니다.

노란색 LED가 2회 깜박입니다.

디스플레이에 WAVE로 전환 알림이 일시적으로 표시된 후 WAVE 준비가 표시됩니다.



주의:

WAVE 모드로 전환 후에 무전기가 자동으로 Wi-Fi를 활성화합니다.

성공 시:

- 점멸하는 노란색 LED가 꺼집니다.
- 디스플레이에 WAVE 연결 완료 아이콘, <통화 그룹 별칭> 및 <채널 색인>이 표시됩니다.

실패 시:

- 실패음이 울립니다.
- 빨간색 LED가 깜박입니다.
- 디스플레이에 WAVE 연결 해제 아이콘이 표시되고 오류 유형에 따라 연결 없음 또는 활성화: 실패가 표시됩니다.



주의:

무전기에 새 설정이 업데이트되면 동기화가 발생합니다. WAVE 모드로 들어가면 무전기에 동기화 중...이 표시됩니다. 동기화가 완료되면 무전기가 홈 화면으로 돌아갑니다.

WAVE 그룹 호출

- 1 채널 선택 노브/버튼을 사용하여 WAVE 통화 그룹을 선택합니다.

- 2 PTT 버튼을 눌러 전화를 전송합니다.

성공하면 디스플레이에 그룹 호출 아이콘과 WAVE 통화 그룹 별칭이 표시됩니다.

실패 시:

- 해제음이 울립니다.
- 디스플레이에 호출 실패함 또는 참가자 없음 알림이 일시적으로 표시됩니다.

WAVE 그룹 호출 수신 및 응답

WAVE 그룹 호출 수신 시:

- 신호음이 울립니다.
- 디스플레이에 그룹 호출 아이콘, WAVE 그룹 호출 그룹 별칭, 발신자 별칭이 표시됩니다.

- 무전기 음소거가 해제되고 호출 수신 시 스피커를 통해 소리가 납니다.

1 PTT 버튼을 눌러 호출에 응답합니다.

2 상대방의 말을 들으려면 **PTT** 버튼을 놓습니다.

WAVE 개별 호출 수신 및 응답

WAVE 개별 호출 수신 시:

- 신호음이 울립니다.
- 디스플레이에 개별 호출 아이콘과 발신자 별칭이 표시됩니다.
- 무전기 음소거가 해제되고 호출 수신 시 스피커를 통해 소리가 납니다.

1 PTT 버튼을 눌러 호출에 응답합니다.



2 상대방의 말을 들으려면 **PTT** 버튼을 놓습니다.

WAVE 모드에서 무전기 모드로 전환

1 다음 중 하나를 수행합니다.

- 프로그래밍된 **무전기 모드** 버튼을 누릅니다. 다음 단계를 건너뛴니다.

-  버튼을 눌러 메뉴로 이동합니다.
-

- 2**  또는  버튼을 눌러 무전기 모드로 이동합니다.  버튼을 눌러 선택합니다.
-

노란색 LED가 2회 깜박입니다.

디스플레이에 무전기로 전환 알림이 일시적으로 표시된 후 무전기 준비가 표시됩니다.

성공 시:

- 점멸하는 노란색 LED가 꺼집니다.
- 상태 표시줄에서 **WAVE** 연결 완료 아이콘이 사라집니다. 디스플레이에 <통화 그룹 별칭> 및 <채널 색인>이 표시됩니다.

WAVE Tactical/5000

활성 WAVE 채널 설정



주의:

WAVE 채널은 CPS를 통해 구성됩니다. WAVE 채널로 들어가면 무전기가 자동으로 Wi-Fi를 활성화하고 WAVE 서버에 로그인합니다.

- 1 버튼을 눌러 메뉴로 이동합니다.

- 2 또는 버튼을 눌러 WAVE 채널로 이동합니다. 버튼을 눌러 선택합니다.

- 3 또는 을 눌러 원하는 WAVE 채널로 이동합니다. 버튼을 눌러 선택합니다.

- 4 또는 버튼을 눌러 활성으로 설정으로 이동합니다. 버튼을 눌러 선택합니다.

디스플레이에서 선택한 채널 옆에 ✓가 표시됩니다.

WAVE 채널 정보 보기

- 1 다음 중 하나를 수행합니다.
 - 프로그래밍된 **WAVE 채널 목록** 버튼을 누릅니다. 다음 단계를 건너뛴니다.
 - 버튼을 눌러 메뉴로 이동합니다.

- 2 또는 버튼을 눌러 WAVE 채널로 이동합니다. 버튼을 눌러 선택합니다.

- 3 또는 을 눌러 원하는 WAVE 채널로 이동합니다. 버튼을 눌러 선택합니다.



- 4 또는 버튼을 눌러 세부 항목 보기로 이동합니다. 버튼을 눌러 선택합니다.



디스플레이에 WAVE 채널 세부 항목이 표시됩니다.

WAVE 끝점 정보 보기

- 1 다음 중 하나를 수행합니다.

- 프로그래밍된 **연락처** 버튼을 누릅니다. **단계 3**(으)로 건너뛴니다.
-  버튼을 눌러 메뉴로 이동합니다.

2  또는  버튼을 눌러 끝점으로 이동합니다.  버튼을 눌러 선택합니다.

3  또는  을 눌러 원하는 WAVE 끝점으로 이동합니다.  버튼을 눌러 선택합니다.



4  버튼을 눌러 세부 항목 보기를 선택합니다.



디스플레이에 WAVE 끝점 세부 항목이 표시됩니다.



WAVE 구성 변경



다음 절차에 따라 WAVE 서버 IP 주소, 사용자 ID 및 암호를 설정합니다.



1  버튼을 눌러 메뉴로 이동합니다.



2  또는  버튼을 눌러 유틸리티로 이동합니다.  버튼을 눌러 선택합니다.



3  또는  버튼을 눌러 무전기 설정으로 이동합니다.  버튼을 눌러 선택합니다.

4  또는  버튼을 눌러 WAVE로 이동합니다.  버튼을 눌러 선택합니다.

5  버튼을 눌러 서버 주소를 선택합니다.  버튼을 서버 주소를 변경합니다.  버튼을 눌러 선택합니다.

6  버튼을 눌러 사용자 ID로 이동합니다.  버튼을 사용자 ID를 변경합니다.  버튼을 눌러 선택합니다.

7  버튼을 눌러 암호로 이동합니다.  버튼을 눌러 WAVE 암호를 보거나 변경합니다.  버튼을 눌러 선택합니다.

8  버튼을 눌러 적용으로 이동합니다.  버튼을 눌러 모든 변경 사항을 적용합니다.

무전기 설정 화면으로 돌아가기 전에 디스플레이에 선택 미니 알림이 잠깐 동안 표시됩니다.

WAVE 그룹 호출

1 필수 그룹 별칭 또는 ID가 있는 WAVE 채널을 선택합니다.

2 PTT 버튼을 눌러 전화를 전송합니다.
녹색 LED가 켜집니다. 첫 번째 텍스트 줄에 **그룹 호출** 아이콘과 별칭이 표시됩니다. 두 번째 텍스트 줄에 WAVE 그룹 별칭이 표시됩니다.

3 다음 중 하나를 수행합니다.

- 통화 허용 신호음(활성화된 경우)이 끝날 때까지 기다렸다가 마이크에 대고 명확히 말합니다.

- PTT 사이드톤(활성화된 경우)이 끝날 때까지 기다렸다가 마이크에 대고 또렷하게 말합니다.
-

4 상대방의 말을 들으려면 PTT 버튼을 놓습니다.

대상 무전기가 응답하면 녹색 LED가 켜집니다. 디스플레이에 **그룹 호출** 아이콘, 별칭 또는 ID, 발신 무전기 별칭 또는 ID가 표시됩니다.

5 가용 채널 표시 기능이 활성화된 경우 발신 무전기에서 PTT 버튼을 놓으면 채널이 사용 가능하여 응답할 수 있음을 나타내는 짧은 경보음이 울립니다. PTT 버튼을 눌러 호출에 응답합니다.

미리 정해진 시간 동안 음성 동작이 없으면 호출이 종료됩니다. 무전기가 호출 시작 전 화면으로 돌아갑니다.

Capacity Max 작업

Capacity Max는 컨트롤 채널 기반 주파수 공유 무전기 시스템입니다. 이 시스템의 무전기 사용자가 사용할 수 있는 기능은 이 장에 나와 있습니다.

PTT(Push-To-Talk) 버튼

PTT 버튼은 두 가지 기본 용도로 사용됩니다.

- 호출 중인 경우에는 **PTT** 버튼을 누르면 호출 중인 다른 무전기에 전송할 수 있습니다. **PTT** 버튼을 누르면 마이크가 활성화됩니다.
- 호출 중이 아닌 동안에는 **PTT** 버튼이 새 호출을 전송하는 데 사용됩니다 참조).

말하려면 **PTT** 버튼을 길게 누릅니다. 상대방의 말을 들으려면 **PTT** 버튼을 놓습니다.

통화 허가음 또는 **PTT** 사이드톤 이 활성화되어 있는 경우, 대화하기 전에 짧은 경보음이 끝날 때까지 기다립니다.

호출 중 무전기에서 채널 프리 표시 기능이 활성화된 경우 (대리점에서 프로그래밍한 경우), 호출 중에 대상 무전기(호출을 수신 중인 무전기)에서 **PTT** 버튼을 놓으면 채널이 사용 가능하여 응답할 수 있음을 나타내는 짧은 경보음이 울립니다.

호출이 중단된 경우 통화 금지 연속음이 계속 들립니다(예: 무전기에서 비상 호출을 수신하는 경우). **PTT** 버튼에서 손을 떼야 합니다.

프로그래밍 가능 버튼

버튼 누름 지속 시간에 따라 대리점에서 프로그래밍 가능 버튼을 무전기 기능의 바로가기로 프로그래밍할 수 있습니다.

짧게 누르기

놓았다 빨리 놓습니다.

길게 누르기

프로그래밍된 지속 시간 동안 누른 상태로 유지합니다.



주의:

비상 버튼의 프로그래밍된 지속 시간에 대한 자세한 내용은 **비상 작동 페이지의 398**을 참조하십시오.

지정 가능한 무전기 기능

다음 무전기 기능은 대리점이나 시스템 관리자에 의해 프로그래밍 가능 버튼에 지정될 수 있습니다.

오디오 환경

사용자가 무전기 작동 환경을 선택할 수 있습니다.

오디오 프로필

사용자가 원하는 오디오 프로필을 선택할 수 있습니다.

Bluetooth® 오디오 스위치

무전기 내부 스피커와 외부 Bluetooth 사용 액세서리 간에 오디오 라우팅을 전환합니다.

Bluetooth 연결

Bluetooth 찾기 및 연결 작업을 시작합니다.

Bluetooth 연결 해제

무전기와 Bluetooth 사용 장치 간의 기존 Bluetooth 연결을 모두 종료합니다.

Bluetooth 검색 가능

무전기가 Bluetooth 검색 가능 모드로 전환될 수 있습니다.

연락처

연락처 목록으로 직접 이동할 수 있습니다.

호출 정보

연락처 목록으로 직접 이동하여 호출 정보를 보낼 수 있는 연락처를 선택할 수 있습니다.

호출 목록

호출 목록을 선택합니다.

비상

프로그래밍에 따라 비상 알람 또는 호출을 시작하거나 취소합니다.

외부 공용 주소(PA)

연결된 PA 스피커 증폭기와 무전기의 내부 PA 시스템 사이의 오디오 라우팅을 켜거나 끕니다.

홈 채널 재설정

새 홈 채널을 설정합니다.

무음 홈 채널 미리 알림

홈 채널 미리 알림을 음소거합니다.

실내 위치

실내 위치를 켜거나 끕니다.

지능형 오디오

지능형 오디오를 켜거나 끕니다.

매뉴얼 다이얼

가입자 ID를 입력하여 개별 호출을 시작합니다.

수동 사이트 로밍

수동 사이트 검색을 시작합니다.

마이크 AGC

내부 마이크 AGC(자동 게인 제어)를 켜거나 끕니다.

알림

알림 목록으로 직접 이동할 수 있습니다.

원터치 액세스

미리 정의된 브로드캐스트, 개별 호출, 전화 호출, 그룹 호출, 호출 정보 또는 단축 문자 메시지를 바로 시작합니다.

옵션 보드 기능

옵션 보드 사용 채널에 대해 옵션 보드 기능을 켜거나 끕니다.

전화

전화 연락처 목록으로 직접 이동할 수 있습니다.

프라이버시

프라이버시 기능을 켜거나 끕니다.

공용 주소(PA)

무전기의 내부 PA 시스템을 켜거나 끕니다.

무전기 별칭 및 ID

무전기 별칭 및 ID를 제공합니다.

원격 모니터링

아무런 표시 없이 대상 무전기의 마이크를 켭니다.

사이트 정보

현재 Capacity Max 사이트 이름 및 ID를 표시합니다.

음성 안내가 활성화되어 있으면 현재 사이트에 대한 사이트 안내 음성 메시지를 재생합니다.

사이트 잠금

사이트 잠금을 켜면 무전기가 현재 사이트만 검색합니다. 사이트 잠금을 끄면 무전기가 현재 사이트에 추가로 다른 사이트를 검색합니다.

텔레메트리 측정 제어

로컬 또는 원격 무전기에서 출력 핀을 제어합니다.

문자 메시지

문자 메시지 메뉴를 선택합니다.

통화 우선 순위 수준 전환

무전기를 통화 우선 순위 높음/보통으로 설정할 수 있습니다.

트릴 강화

트릴 강화를 켜거나 끕니다.

음성 안내 켜기/끄기

음성 안내를 켜거나 끕니다.

채널에 대한 음성 안내

현재 채널에 대한 존 및 채널 안내 음성 메시지를 재생합니다. 음성 안내가 비활성화되어 있으면 이 기능을 사용할 수 없습니다.

Wi-Fi

Wi-Fi를 켜거나 끕니다.

존 선택

존 목록에서 선택할 수 있습니다.

지정 가능한 설정 또는 유틸리티 기능

다음 무전기 설정 또는 유틸리티 기능을 프로그래밍 가능 버튼에 지정할 수 있습니다.

톤/경보

전체 톤과 경보를 켜거나 끕니다.

백라이트

디스플레이 백라이트를 켜거나 끕니다.

채널 조정

프로그래밍에 따라 채널을 이전 채널 또는 다음 채널로 변경합니다.

디스플레이 모드

주간/야간 디스플레이 모드를 켜거나 끕니다.



출력 수준

전송 전력 레벨을 높게 설정하거나 낮게 설정합니다.



프로그래밍된 기능에 액세스

다음 절차에 따라 무전기에서 프로그래밍된 기능에 액세스합니다.

- 1 다음 중 하나를 수행합니다.
 - 프로그래밍된 버튼을 누릅니다. 단계 3로 진행합니다.
 -  버튼을 눌러 메뉴로 이동합니다.

- 2  또는  버튼을 눌러 메뉴 기능으로 이동하고  버튼을 눌러 기능을 선택하거나 하위 메뉴로 진입합니다.

- 3 다음 중 하나를 수행합니다.

- 이전 화면으로 돌아가려면  버튼을 누릅니다.
- 홈 화면으로 돌아가려면  버튼을 길게 누릅니다.

일정 시간 사용하지 않으면 무전기에서 메뉴가 자동으로 종료되고 홈 화면으로 돌아갑니다.

메뉴 탐색 버튼은 키패드 마이크에서도 사용할 수 있습니다. 키패드 마이크 버튼 페이지의 33을 참조하십시오.

상태 표시기

이 장에서는 무전기에 사용되는 상태 표시등과 신호음을 설명합니다.







아이콘

무전기의 LCD(Liquid Crystal Display)에 무전기 상태, 텍스트 항목 및 메뉴 항목이 표시됩니다.

표 2: 디스플레이 아이콘







다음 아이콘은 무전기 디스플레이 상단의 상태 표시줄에 표시되는 아이콘입니다. 아이콘은 모양 또는 사용 순서와 채널 별로 맨 왼쪽에 배열됩니다.

	BeiDou에서만 사용 가능¹ BeiDou 전용 기능이 활성화되어 있습니다. 고정 위치를 사용할 수 있는 경우 아이콘이 켜진 상태로 유지됩니다.
	Bluetooth 연결됨 Bluetooth 기능이 활성화되어 있습니다. 원격 Bluetooth 장치가 연결되어 있으면 이 아이콘은 켜진 상태로 유지됩니다.

	Bluetooth 연결 안됨 Bluetooth 기능은 활성화되어 있지만 원격 Bluetooth 장치가 연결되어 있지 않습니다.
	DGNA 무전기가 DGNA 통화 그룹에 있습니다.
	비상 무전기가 비상 모드에 있습니다.
	GNSS 사용 가능 GNSS 기능이 활성화되어 있습니다. 고정 위치를 사용할 수 있는 경우 아이콘이 켜진 상태로 유지됩니다.
	GNSS 사용 불가 GNSS 기능이 활성화되어 있지만 위성에서 데이터가 수신되지 않습니다.
	대용량 데이터 무전기에서 대용량 데이터를 수신 중이며 채널이 사용 중입니다.

¹ XiR M8660i/XiR M8668i/CM7668i에만 적용 가능.

	실내 위치 기능² 실내 위치 상태가 켜져 있고 사용 가능합니다.
	실내 위치 사용 불가능² 실내 위치 상태가 켜져 있지만 Bluetooth 비활성 상태 또는 Bluetooth 가 비콘 스캔을 일시 중지하여 사용할 수 없습니다.
	음소거 모드 음소거 모드가 활성화되고 스피커가 음소거됩니다.
	알림 알림 목록에 하나 이상의 부재 중 이벤트가 있습니다.
	옵션 보드 옵션 보드가 활성화되어 있습니다. (옵션 보드 지원 모델에만 해당)
	옵션 보드 비활성화 옵션 보드가 비활성화되어 있습니다.

	무선 프로그래밍 지연 타이머 무전기가 자동으로 재시작되기 전까지 남은 시간을 나타냅니다.
	우선 순위 1 우선 순위 통화 그룹 1을 나타냅니다.
	우선 순위 2 우선 순위 통화 그룹 2을 나타냅니다.
	RSSI(Received Signal Strength Indicator, 수신 신호 강도 표시기) 표시되는 막대 수는 무선 신호 강도를 나타냅니다. 막대 4개는 가장 강력한 신호를 의미합니다. 이 아이콘은 수신하는 동안에만 표시됩니다.
	응답 금지 응답 금지가 활성화되었습니다.
	벨소리만 벨 모드를 사용합니다.

² 최신 소프트웨어 및 하드웨어와 모델에만 적용됩니다.

	보안 프라이버시 기능이 활성화되어 있습니다.
	공유된 주파수 무선기가 공유 컨트롤 채널에 잠겨 있음을 나타냅니다.
	무음 무음 모드를 사용합니다.
	사이트 로밍 사이트 로밍 기능이 활성화되어 있습니다.
	상태 새로운 상태 메시지를 나타냅니다.
	신호음 비활성화 신호음이 꺼져 있습니다.
	비보안 프라이버시 기능이 비활성화되어 있습니다.

	Wi-Fi 우수³ Wi-Fi 신호가 우수합니다.
	Wi-Fi 양호³ Wi-Fi 신호가 양호합니다.
	Wi-Fi 평균³ Wi-Fi 신호가 평균입니다.
	Wi-Fi 불량³ Wi-Fi 신호가 약합니다.
	Wi-Fi 사용할 수 없음³ Wi-Fi 신호를 사용할 수 없습니다.

표 3: 고급 메뉴 아이콘

다음 아이콘은 메뉴 항목 옆에 표시되어 두 옵션 중에서 선택할 수 있도록 하거나 두 옵션을 제공하는 하위 메뉴가 있음을 나타냅니다.

	확인란(선택됨) 옵션이 선택되었음을 나타냅니다.
---	--------------------------------------

³ XiR M8668i/CM7668i에만 적용됨.

	<p>확인란(비어 있음) 옵션이 선택되어 있지 않음을 나타냅니다.</p>
	<p>단색 검은색 상자 하위 메뉴가 있는 메뉴 항목에 대해 선택된 옵션을 나타냅니다.</p>

표 4: Bluetooth 장치 아이콘

다음 아이콘은 장치 유형을 나타내는 데 사용할 수 있는 Bluetooth 사용 장치 목록의 항목 옆에도 나타납니다.

	<p>Bluetooth 오디오 장치 헤드셋과 같은 Bluetooth 사용 오디오 장치입니다.</p>
	<p>Bluetooth 데이터 장치 스캐너와 같은 Bluetooth 사용 데이터 장치입니다.</p>
	<p>Bluetooth PTT 장치 POD(PTT 전용 장치)와 같은 Bluetooth 사용 PTT 장치입니다.</p>

표 5: 호출 아이콘

다음 아이콘은 호출 중에 디스플레이에 나타납니다. 이 아이콘은 연락처 목록에 표시되어 별칭이나 ID 유형을 나타내기도 합니다.

	<p>Bluetooth로 PC 호출 Bluetooth로 PC 호출이 진행 중임을 나타냅니다.</p> <p>연락처 목록에서는 Bluetooth로 PC 호출 별칭(이름) 또는 ID(번호)를 나타냅니다.</p>
	<p>높은 우선 순위 통화 높은 수준의 통화 우선 순위가 활성화되어 있음을 나타냅니다.</p>
	<p>DGNA 호출 DGNA 호출이 진행 중임을 나타냅니다.</p>
	<p>발신 호출 디스패치 호출 연락처 유형은 타사 문자 메시지 서버를 사용하여 디스패치 PC에 문자 메시지를 보내는 데 사용됩니다.</p>

	<p>그룹 호출/전체 호출 진행 중인 그룹 호출 또는 전체 호출을 나타냅니다.</p> <p>연락처 목록에서는 그룹 별칭(이름) 또는 ID(번호)를 나타냅니다.</p>
	<p>개별 호출 진행 중인 개별 호출을 나타냅니다.</p> <p>연락처 목록에서는 가입자 별칭(이름) 또는 ID(번호)를 나타냅니다.</p>
	<p>그룹 호출/전체 호출로 전화 통화 그룹 호출 또는 전체 호출로 전화 통화가 진행 중임을 나타냅니다.</p> <p>연락처 목록에서는 그룹 별칭(이름) 또는 ID(번호)를 나타냅니다.</p>
	<p>개별 호출로 전화 통화 개별 호출로 전화 통화가 진행 중임을 나타냅니다.</p> <p>연락처 목록에서는 통화 별칭(이름) 또는 ID(번호)를 나타냅니다.</p>

표 6: 작업 티켓 아이콘

다음 아이콘이 작업 티켓 폴더의 디스플레이에 잠시 나타납니다.

	<p>모든 작업 나열된 모든 작업을 나타냅니다.</p>
	<p>새 작업 새 작업을 나타냅니다.</p>
	<p>진행 중 작업을 전송 중입니다. 이것은 작업 티켓 전송 실패 또는 전송 성공의 표시 전에 나타납니다.</p>
	<p>전송 실패 작업을 보낼 수 없습니다.</p>
	<p>전송 성공 작업이 성공적으로 전송되었습니다.</p>
	<p>우선 순위 1 작업의 우선 순위 레벨 1을 나타냅니다.</p>

	<p>우선 순위 2 작업의 우선 순위 레벨 2을 나타냅니다.</p>
	<p>우선 순위 3 작업의 우선 순위 레벨 3을 나타냅니다.</p>

표 7: 미니 알림 아이콘

작업을 수행하면 다음 아이콘이 디스플레이에 잠시 나타납니다.

	<p>전송 실패(부정) 작업이 실패했습니다.</p>
	<p>전송 성공(긍정) 작업이 성공적으로 수행되었습니다.</p>
	<p>진행 중인 전송(전환) 전송 중입니다. 이 아이콘은 전송 성공 또는 전송 실패를 나타내기 전에 표시됩니다.</p>

표 8: 보낸 문자함 아이콘

다음 아이콘은 보낸 문자함 폴더에서 디스플레이의 오른쪽 상단에 표시됩니다.

	<p>진행 중 가입자 별칭 또는 ID로의 문자 메시지가 전송 대기 중이며 승인을 기다리고 있습니다. 그룹 별칭 또는 ID로 문자 메시지가 전송 대기 중입니다.</p>
	<p>개별 또는 그룹 메시지 읽음 문자 메시지를 읽었습니다.</p>
	<p>개별 또는 그룹 메시지 읽지 않음 읽지 않은 문자 메시지가 있습니다.</p>
	<p>전송 실패 문자 메시지를 전송하지 못했습니다.</p>



또는

**전송 성공**

문자 메시지를 성공적으로 보냈습니다.

LED 표시등

LED 표시등은 무전기의 작동 상태를 표시합니다.

빨간색으로 깜박임

전원을 켤 때 자가 테스트에 실패했습니다.

무전기가 비상 전송을 수신 중입니다.

무전기가 배터리 부족 상태에서 전송 중입니다.

무전기에 ARTS(Auto-Range Transponder System)가 구성된 경우 무전기가 통화권 범위를 이탈했습니다.

음소거 모드가 활성화되었습니다.

녹색으로 켜져 있음

무전기 전원이 켜지고 있습니다.

무전기가 전송 중입니다.

무전기가 호출 정보 또는 비상 전송을 수신 중입니다.

녹색으로 깜박임

무전기가 호출 또는 데이터를 수신 중입니다.

무전기에서 무선을 통한 무선 프로그래밍 전송을 검색 중입니다.

무전기에서 무선 동작을 감지하고 있습니다.

**주의:**

디지털 프로토콜의 특성에 따라 이 동작은 무전기의 프로그래밍된 채널에 영향을 줄 수도 있고 주지 않을 수도 있습니다.

녹색으로 2회 깜박임

무전기가 프라이머시 호출 또는 데이터를 수신 중입니다.

노란색으로 켜져 있음

무전기가 Bluetooth 검색 가능 모드에 있습니다.

노란색으로 깜박임

무전기가 호출 정보에 응답해야 합니다.

노란색으로 2회 깜박임

무전기에 자동 로밍이 활성화되었습니다.

무전기에서 새 사이트를 능동 검색하고 있습니다.

무전기가 그룹 호출 정보에 응답해야 합니다.

무전기가 잠겨 있습니다.

신호음

다음은 무전기 스피커를 통해 울리는 신호음입니다.



고음



저음

가청음

가청음은 무전기의 상태 또는 수신된 데이터에 대한 무전기의 응답을 청각적으로 나타냅니다.



연속음

단조로운 톤입니다. 종료될 때까지 계속 울립니다.



주기적 신호음

무전기에 설정된 시간에 따라 주기적으로 톤이 울립니다. 톤이 자체적으로 시작, 중지 및 반복됩니다.



반복음

사용자가 종료할 때까지 자체적으로 반복되는 단일음입니다.



일시적 음

무전기에 설정된 시간에 따라 톤이 짧게 한 번 울립니다.

상태 표시음

상태 표시음은 작업을 수행한 후 무전기의 상태를 청각적으로 나타냅니다.



선택음



해제음

등록

사용자가 수신할 수 있는 등록 관련 메시지가 많이 있습니다.

등록 중

일반적으로 전원을 켜고, 통화 그룹을 변경하거나, 사이트 로밍 중에 등록이 시스템에 전송됩니다. 무전기가 사이트에 등록하지 못하면 자동으로 다른 사이트에 로밍을 시도합니다. 무전기는 일시적으로 로밍 목록에서 등록을 시도했던 사이트를 제거합니다.

무전기가 로밍할 사이트를 검색 중이거나 사이트를 성공적으로 찾았지만 무전기에서 등록 메시지에 응답하기를 기다리는 중임을 의미하는 표시입니다.

무전기에 등록 중이 표시되면 신호음이 울리고 노란색 LED가 2회 깜박이면서 사이트 검색을 알려줍니다.

계속 표시되면 사용자는 위치를 변경하거나 허용되는 경우 수동으로 다른 사이트로 로밍해야 합니다.

통화권을 벗어남

무전기가 시스템이나 현재 사이트에서 신호를 감지할 수 없는 경우 무전기가 수신 범위를 벗어난 것으로 간주합니다. 일반적으로 이 표시는 무전기가 지리적인 아웃바운드 무선 주파수(RF) 통화 범위를 벗어난 것을 의미합니다.

무전기에 통화권을 벗어남이 표시되면 신호음이 반복해서 울리고 빨간색 LED가 깜박입니다.

양호한 RF 통화 범위에 있어도 무전기에 통화권을 벗어남 표시가 계속 나타나면 대리점이나 시스템 관리자에게 문의하십시오.

통화 그룹 가입 실패

등록 도중 무전기는 채널이나 UKP(Unified Knob Position)에 지정된 통화 그룹에 가입을 시도합니다.

가입 상태가 실패인 경우 무전기가 가입하려는 통화 그룹에서 전화를 걸거나 받을 수 없습니다.

무전기가 통화 그룹에 가입하지 못한 경우, 홈 화면에 강조된 배경과 함께 UKP 별칭이 표시됩니다.

무전기에 가입 오류가 표시되면 대리점 또는 시스템 관리자에게 문의하십시오.

등록 거부됨

시스템 등록이 수락되지 않는 경우 등록 거부됨이 표시됩니다.

무전기는 무전기 사용자에게 등록이 거부된 특정 이유를 표시하지 않습니다. 일반적으로, 시스템 운영자가 무전기의 시스템 액세스를 비활성화한 경우 등록이 거부됩니다.

무전기 등록이 거부되면, 무전기에 등록 거부됨이 표시되고 노란색 LED가 2번 깜박이면서 사이트 검색을 알려줍니다.

존 및 채널 선택





이 장에서는 무전기에서 존 또는 채널을 선택하는 방법에 대해 설명합니다.



최대 250개의 Capacity Max 존(존마다 채널 최대 160개)으로 무전기를 프로그래밍할 수 있습니다. 각 Capacity Max 영역에는 최대 16개의 위치가 포함되어 있습니다. 각 Capacity Max 영역에는 최대 16개의 위치가 포함되어 있습니다.

존 선택

다음 절차에 따라 무전기에서 원하는 존을 선택합니다.

- 1 다음 중 하나를 수행합니다.
 - 프로그래밍된 **존 선택** 버튼을 누릅니다. 단계 3로 진행합니다.
 -  버튼을 눌러 메뉴로 이동합니다.





- 2  또는  버튼을 눌러 존으로 이동합니다.
 버튼을 눌러 선택합니다.
디스플레이에  및 현재 존이 표시됩니다.

- 3  또는  버튼을 눌러 원하는 존으로 이동합니다.  버튼을 눌러 선택합니다.
디스플레이에 <존> 선택 완료가 잠시 표시된 후 선택한 존 화면으로 돌아갑니다.

별칭 검색을 사용하여 존 선택

다음 절차에 따라 별칭 검색을 사용하여 무전기에서 원하는 존을 선택합니다.

- 1  버튼을 눌러 메뉴로 이동합니다.

- 2  또는  버튼을 눌러 존으로 이동합니다.
 버튼을 눌러 선택합니다.
디스플레이에  및 현재 존이 표시됩니다.

- 3 원하는 별칭의 첫 문자를 입력합니다.
디스플레이에 커서가 깜박입니다.

- 4 원하는 별칭의 나머지 문자를 입력합니다.
별칭 검색은 대소문자를 구분하지 않습니다. 같은 이름의 항목이 두 개 이상 있으면 디스플레이에는 목록에 첫 번째로 나열된 항목이 표시됩니다.
첫 번째 텍스트 줄에 입력한 문자가 표시됩니다. 다음 텍스트 줄에는 간략히 나열된 검색 결과가 표시됩니다.

- 5  버튼을 눌러 선택합니다.
디스플레이에 <존> 선택 완료가 잠시 표시된 후 선택한 존 화면으로 돌아갑니다.

호출 유형 선택

채널 선택 노브를 사용하여 호출 유형을 선택합니다. 호출 유형은 무전기가 프로그래밍된 방식에 따라 그룹 호출, 브로드캐스트 호출, 전체 호출 또는 개별 호출일 수 있습니다. 채널 선택 노브를 다른 위치(호출 유형이 할당된 위치)로 변경하는 경우 무전기가 **Capacity Max** 시스템에 다시 등록됩니다. 무전기는 새 채널 선택 노브 위치 호출 유형에 프로그래밍된 통화 그룹 ID를 사용하여 등록됩니다.

프로그래밍되지 않은 채널을 선택하면 무전기가 작동하지 않으므로 채널 선택 노브를 사용하여 프로그래밍된 채널을 선택해야 합니다.

무전기에 여러 존이 있는 경우 원하는 존이 표시되면 프로그래밍된 채널 선택 노브를 돌려 호출 유형을 선택합니다.

사이트 선택

사이트는 특정 지역의 통신 범위를 제공합니다. 멀티 사이트 네트워크에서는 현재 사이트의 신호 레벨이 허용 가능한 레벨 아래로 떨어지면 **Capacity Max** 무전기가 새 사이트를 자동으로 검색합니다.

Capacity Max 시스템은 최대 250개의 사이트를 지원할 수 있습니다

로밍 요청

현재 사이트의 신호가 허용 가능한 레벨인 경우에도 로밍 요청을 사용하면 무전기에 다른 사이트를 검색하도록 지시할 수 있습니다.

사용 가능한 사이트가 없는 경우:

- 무전기 디스플레이에 검색 중이 표시되고 계속해서 사이트 목록 전체를 검색합니다.
- 이전 사이트가 아직 사용 가능한 경우, 무전기는 이전 사이트로 되돌아갑니다.



주의:

이 기능은 대리점에서 프로그래밍합니다.

프로그래밍된 **수동 사이트 로밍** 버튼을 누릅니다.

무전기가 새 사이트로 전환되면 톤이 울립니다. 디스플레이에 사이트 ID <사이트 번호>가 표시됩니다.

사이트 잠금 켜기/끄기

사이트 잠금을 켜면 무전기가 현재 사이트만 검색합니다. 사이트 잠금을 끄면 무전기가 현재 사이트에 추가로 다른 사이트를 검색합니다.

프로그래밍된 **사이트 잠금** 버튼을 누릅니다.

사이트 잠금 기능이 켜진 경우:

- 무전기가 현재 사이트로 잠기면 성공음이 울립니다.
- 디스플레이에 사이트 잠금 완료가 표시됩니다.

사이트 잠금 기능이 꺼진 경우:

- 무전기가 잠기지 않으면 해제음이 울립니다.
- 디스플레이에 사이트 해제 완료가 표시됩니다.

사이트 제한

Capacity Max 시스템에서 무전기 관리자가 무전기를 사용하거나 사용할 수 없는 네트워크 사이트를 설정할 수 있습니다.

허용된 사이트와 허용되지 않은 사이트의 목록을 변경하기 위해 무전기를 다시 프로그래밍할 필요가 없습니다. 무전기

를 허용하지 않는 사이트에 등록을 시도하는 경우, 무전기에 사이트에서 거부되었다는 표시가 수신됩니다. 그런 다음 무전기가 자동으로 다른 네트워크 사이트를 검색합니다.

사이트 제한이 발생하면 무전기에 등록 거부됨이 표시되고 노란색 LED가 2번 깜박이면서 사이트 검색을 알려줍니다.

사이트 트렁킹

사이트는 트렁킹 시스템으로 간주되도록 트렁크 컨트롤러와 통신할 수 있어야 합니다.

사이트가 시스템에서 트렁크 컨트롤러와 통신할 수 없는 경우 무전기가 사이트 트렁킹 모드로 전환됩니다. 사이트 트렁킹 중에는 무전기가 사용자에게 제한된 기능의 사용자라는 사실을 알려주기 위해 주기적으로 청각적 및 시각적 표시를 제공합니다.

무전기가 사이트 트렁킹 상태인 경우 무전기에 사이트 트렁킹이 표시되고 신호음이 반복적으로 울립니다.

무전기는 사이트 트렁킹 상태에서도 그룹 및 개별 음성 호출이 가능할 뿐 아니라 동일한 사이트 내에서 다른 무전기에 문자 메시지를 전송할 수 있습니다. 음성 콘솔, 로깅 레코더, 전화 게이트웨이 및 데이터 애플리케이션은 사이트에서 무전기와 통신할 수 없습니다.

사이트 트렁킹 상태일 때 여러 사이트의 호출에 대응하는 무전기의 경우 동일한 사이트 내에서만 다른 무전기와 통신할

수 있습니다. 다른 사이트에서 주고 받는 통신은 손실됩니다.



주의:

무전기의 현재 위치를 담당하는 사이트가 여러 개이고 그런 사이트 중 하나가 사이트 트렁킹 상태로 전환되면 통신 범위 내에서 무전기가 다른 사이트로 로밍됩니다.

호출

이 장에서는 통화를 수신, 응답, 발신 및 중지하는 방법을 설명합니다.

채널을 선택하고 나면 다음 기능 중 하나를 사용하여 가입자 별칭 또는 ID, 그룹 별칭 또는 ID를 선택할 수 있습니다.

별칭 검색

이 방법은 그룹 호출, 개별 호출 및 전체 호출 전용으로 키패드 마이크와 함께 사용됩니다.

연락처 목록

이 방법을 사용하면 연락처 목록으로 직접 이동할 수 있습니다.

매뉴얼 다이얼(연락처 사용)

이 방법은 개별 호출 및 전화 통화 전용으로 키패드 마이크와 함께 사용됩니다.

프로그래밍된 숫자 키

이 방법은 그룹 호출, 개별 호출 및 전체 호출 전용으로 키패드 마이크와 함께 사용됩니다.



주의:

하나의 숫자 키에는 별칭 또는 ID를 하나만 할당할 수 있지만 하나의 별칭 또는 ID에는 숫자 키를 두 개 이상 연결할 수 있습니다. 키패드 마이크의 모든 숫자 키를 지정할 수 있습니다. 자세한 내용은 [프로그래밍 가능 숫자 키에 항목 할당 페이지의 383](#) 부분을 참조하십시오.

프로그래밍된 원터치 액세스 버튼

이 방법은, 개별 호출 및 전화 통화 전용입니다.

프로그래밍된 버튼을 짧게 또는 길게 눌러 한 ID만 원터치 액세스 버튼에 지정할 수 있습니다. 무전기에 여러 개의 원터치 액세스 버튼을 프로그래밍할 수 있습니다.

프로그래밍 가능 버튼

이 방법은 전화 통화 전용(참조)입니다.

블룸/채널 선택기 노브

이 방법은 수동으로 가입자 별칭 또는 ID, 그룹 별칭 또는 ID를 선택합니다.

무전기가 발신 중이면 녹색 LED가 켜지고 무전기가 수신 중이면 녹색으로 깜박입니다.



주의:

무전기가 송신 중이면 녹색 LED가 켜지고 무전기가 프라이버시 활성화 호출을 수신 중이면 녹색으로 2회 깜박입니다.

프라이버시 활성화 호출의 스크램블을 풀려면 발신 무전기(수신 중인 호출을 보낸 무전기)와 동일한 프라이버시 키 또는 키 값과 키 ID(대리점에서 프로그래밍함)가 무전기에 있어야 합니다.

자세한 내용은 [개인 정보 보호 페이지의 433](#) 부분을 참조하십시오.

그룹 호출

그룹 사용자로부터 호출을 송수신하려면 무전기가 해당 그룹의 일부로 구성되어야 합니다.

그룹 호출 전송

그룹 사용자에게 호출을 전송하려면 무전기를 해당 그룹의 일부로 구성해야 합니다. 다음 절차에 따라 무전기에서 그룹 호출을 전송합니다.

1 다음 중 하나를 수행합니다.

- 활성화 그룹 별칭 또는 ID가 있는 채널을 선택합니다. [호출 유형 선택 페이지의 55](#)을 참조하십시오.

- 프로그래밍된 **원터치 액세스** 버튼을 누릅니다.

2 PTT 버튼을 눌러 전화를 전송합니다.

녹색 LED가 켜집니다. 첫 번째 텍스트 줄에 **그룹 호출** 아이콘과 별칭이 표시됩니다.

3 다음 중 하나를 수행합니다.

- 통화 허용 신호음(활성화된 경우)이 끝날 때까지 기다렸다가 마이크에 대고 명확히 말합니다.
- **PTT** 사이드톤(활성화된 경우)이 끝날 때까지 기다렸다가 마이크에 대고 또렷하게 말합니다.

4 상대방의 말을 들으려면 **PTT** 버튼을 놓습니다.

대상 무전기가 응답하면 녹색 LED가 켜집니다. 디스플레이에 **그룹 호출** 아이콘, 별칭 또는 ID, 발신 무전기 별칭 또는 ID가 표시됩니다.

5 채널 프리 표시 기능이 활성화된 경우 발신 무전기에서 **PTT** 버튼을 놓으면 채널이 사용 가능하여 응답할 수 있음을 나타내는 짧은 경보음이 울립니다. **PTT** 버튼을 눌러 호출에 응답합니다.



미리 정해진 시간 동안 음성 동작이 없으면 호출이 종료됩니다.



호출 발신자는  버튼을 눌러 그룹 호출을 종료할 수 있습니다.

연락처 목록을 사용하여 그룹 호출 전송

다음 절차에 따라 연락처 목록을 사용하여 무전기에서 그룹 호출을 전송합니다.

- 1  버튼을 눌러 메뉴로 이동합니다.

- 2  또는  버튼을 눌러 연락처로 이동합니다.
 버튼을 눌러 선택합니다.

- 3  또는  버튼을 눌러 원하는 별칭 또는 ID로 이동합니다.  버튼을 눌러 선택합니다.

- 4 **PTT** 버튼을 눌러 전화를 전송합니다.
녹색 LED가 켜집니다.
첫 번째 줄에 가입자 별칭 또는 ID가 표시됩니다. 두 번째 줄에는 그룹 호출과 **그룹 호출** 아이콘이 표시됩니다.

5 다음 중 하나를 수행합니다.

- 통화 허용 신호음(활성화된 경우)이 끝날 때까지 기다렸다가 마이크에 대고 명확히 말합니다.
- **PTT** 사이드톤(활성화된 경우)이 끝날 때까지 기다렸다가 마이크에 대고 또렷하게 말합니다.

6 상대방의 말을 들으려면 **PTT** 버튼을 놓습니다.

그룹 내 모든 사용자가 응답하면 녹색 LED가 깜박입니다. 디스플레이에 **그룹 호출** 아이콘, 별칭 또는 ID, 발신 무전기 별칭 또는 ID가 표시됩니다.

7 채널 프리 표시 기능이 활성화된 경우 발신 무전기에서 **PTT** 버튼을 놓으면 채널이 사용 가능하여 응답할 수 있음을 나타내는 짧은 경보음이 울립니다. **PTT** 버튼을 눌러 호출에 응답합니다.

미리 정해진 시간 동안 음성 동작이 없으면 호출이 종료됩니다.

호출 발신자는  버튼을 눌러 그룹 호출을 종료할 수 있습니다.

짧은 톤이 울립니다. 디스플레이에 통화 종료 표시가 됩니다.

프로그래밍 가능 숫자 키를 사용하여 그룹 호출 전송

다음 절차에 따라 프로그래밍 가능한 숫자 키를 사용하여 무전기에서 그룹 호출을 전송합니다.

- 1 홈 화면에 있는 경우 프로그래밍된 숫자 키를 길게 눌러 미리 정의된 별칭이나 ID로 이동합니다.

특정 모드에서 항목에 숫자 키를 지정할 경우 다른 모드에서 숫자 키를 길게 누르면 이 기능이 지원되지 않습니다.

항목에 숫자 키가 연결되어 있지 않으면 해제음이 울립니다.

- 2 **PTT** 버튼을 눌러 전화를 전송합니다.
녹색 LED가 켜집니다.

- 3 상대방의 말을 들으려면 **PTT** 버튼을 놓습니다.
그룹 내 모든 사용자가 응답하면 녹색 LED가 깜박입니다.

- 4 채널 프리 표시 기능이 활성화된 경우 발신 무전기에서 **PTT** 버튼을 놓으면 채널이 사용 가능하여 응답할

수 있음을 나타내는 짧은 경보음이 울립니다. **PTT** 버튼을 눌러 호출에 응답합니다.

미리 정해진 시간 동안 음성 동작이 없으면 호출이 종료됩니다. 무전기가 호출 시작 전 화면으로 돌아갑니다.



호출 발신자는  버튼을 눌러 그룹 호출을 종료할 수 있습니다.

자세한 내용은 [프로그래밍 가능 숫자 키에 항목 할당 페이지의 383](#) 부분을 참조하십시오.

별칭 검색을 사용하여 그룹 호출 전송



별칭이나 영숫자 검색을 사용하여 원하는 가입자 별칭을 검색할 수도 있습니다. 이 기능은 연락처에 있는 동안에만 사용할 수 있습니다. 절차에 따라 별칭 검색을 사용하여 호출합니다.

- 1  버튼을 눌러 메뉴로 이동합니다.





2  또는  버튼을 눌러 연락처로 이동합니다.

 버튼을 눌러 선택합니다.

디스플레이에 항목이 알파벳 순으로 표시됩니다.

3  또는  을 눌러 원하는 가입자 별칭 또는 ID 로 이동합니다. 디스플레이의 첫 번째 줄에 전화 번호:가 표시됩니다. 디스플레이의 두 번째 줄에 커서 가 깜박입니다. 키패드로 전화 번호를 입력합니다.

4  버튼을 눌러 선택합니다. 선택한 항목이 비어 있으면 해제음이 울리고 디스플레이에 잘못된 전화 번호가 표시됩니다.



5  또는  을 눌러 전화 연결 통화 및  버튼을 눌러 선택합니다.로 이동합니다. 연락처 목록에 액세스 코드가 사전 구성되어 있지 않은 경우 디스플레이의 첫 번째 줄에 액세스 코드:가 표시됩니다. 디스플레이의 두 번째 줄에 커서가 깜박입니다. 액세스 코드를 입력하고  버튼을 눌러 계속합니다. 성공하면 DTMF 톤이 울립니다. 전화기 사용자의 발신음이 들립니다. 디스플레이의 첫 번째 줄에 가입자 별칭 또는 ID, RSSI 아이콘이 표시됩니다. 디스플레이의

두 번째 줄에 전화 및 전화 아이콘이 표시됩니다. 실패하면 톤이 울리고 디스플레이에 전화 접속 통화 실패가 표시됩니다. 무전기가 액세스 코드 입력 화면으로 돌아갑니다. 연락처 목록에 액세스 코드가 사전 구성되어 있는 경우 무전기가 호출을 시작하기 전에 있었던 화면으로 돌아갑니다.

6 말을 하려면 **PTT** 버튼을 누르고, 상대방의 말을 들으려면 **PTT** 버튼을 놓습니다. 전송 중에는 **RSSI** 아이콘이 사라집니다.

7 추가 숫자를 입력하려면, 전화로 요청된 경우 다음 중 하나를 수행합니다.

- 아무 키패드 키를 눌러 추가 숫자 입력을 시작합니다. 디스플레이의 첫 번째 줄에 추가 숫자:가 표시됩니다. 디스플레이의 두 번째 줄에 커서가 깜박입니다. 추가 숫자를 입력하고  버튼을 눌러 계속합니다. DTMF 톤이 울리고 무전기가 이전 화면으로 돌아갑니다.
 - **원터치 액세스** 버튼을 누릅니다. DTMF 톤이 울립니다. **원터치 액세스** 버튼 항목이 비어 있으면 해제음이 울립니다.
-

- 8  버튼을 눌러 통화를 종료합니다. 연락처 목록에 액세스 해제 코드가 사전 구성되어 있지 않은 경우 디스플레이의 첫 번째 줄에 액세스 해제 코드:가 표시됩니다. 디스플레이의 두 번째 줄에 커서가 깜박입니다. 액세스 해제 코드를 입력하고  버튼을 눌러 계속합니다. 무전기가 이전 화면으로 돌아갑니다. DTMF 톤이 울리고 디스플레이에 전화 종료 중이 표시됩니다. 성공하면 톤이 울리고 디스플레이에 전화 종료가 표시됩니다. 무전기가 전화 화면으로 돌아갑니다. 실패하면 무전기가 전화 화면으로 돌아갑니다. 전화 연락처 화면에서 **PTT** 버튼을 누르면 톤이 울리고 디스플레이에 통화 시도 시 'OK'를 누르시오가 표시됩니다. 전화기 사용자가 통화를 종료하면 톤이 울리고 디스플레이에 전화 종료가 표시됩니다. 전화에 필요한 숫자를 추가로 입력하는 동안 통화를 종료하면 무전기가 호출 시작 전 화면으로 돌아갑니다.



- 9 채널 프리 표시 기능이 활성화된 경우 발신 무전기에서 **PTT** 버튼을 놓으면 채널이 사용 가능하여 응답할 수 있음을 나타내는 짧은 경보음이 울립니다. **PTT** 버튼을 눌러 호출에 응답합니다.

미리 정해진 시간 동안 음성 동작이 없으면 호출이 종료됩니다. 신호음이 울립니다. 디스플레이에 통화 종료가 표시됩니다.

호출 발신자는  버튼을 눌러 그룹 호출을 종료할 수 있습니다.



주의:

채널 액세스 동안  을 눌러 호출 시도를 취소하면 신호음이 울립니다. 또는 별칭 검색을 종료합니다.  또는  버튼을 눌러 별칭 검색을 종료합니다. 액세스 해제 코드가 미리 구성된 상태에서 호출 중에 **원터치 액세스** 버튼을 누르거나, 추가 숫자 입력 시 액세스 해제 코드를 입력하면 무전기에서 호출 종료를 시도합니다. 채널에 액세스하거나, 액세스/액세스 해제 코드를 입력하거나, 추가 숫자를 입력하는 중에는 무전기가 켜기/끄기 버튼, 볼륨 노브, 채널 락커에만 응답합니다. 이 외에 다른 잘못된 버튼을 누르면 톤이 울립니다.

그룹 호출에 응답

다음 절차에 따라 무전기에서 그룹 호출에 응답합니다.

그룹 호출 수신 시:

- 녹색 LED가 깜박입니다.
- 디스플레이의 오른쪽 상단에 **그룹 호출** 아이콘이 표시됩니다.

- 첫 번째 텍스트 줄에 발신자 별칭이 표시됩니다.
- 두 번째 텍스트 줄에 그룹 호출 별칭이 표시됩니다.
- 무전기 음소거가 해제되고 호출 수신 시 스피커를 통해 소리가 납니다.

1 다음 중 하나를 수행합니다.

- 채널 프리 표시 기능이 활성화된 경우 발신 무전기에서 **PTT** 버튼을 놓으면 채널이 사용 가능하여 응답할 수 있음을 나타내는 짧은 경보음이 울립니다. **PTT** 버튼을 눌러 호출에 응답합니다.
- 음성 중단 기능이 활성화된 경우 **PTT** 버튼을 누르면 발신 무전기에서 오디오가 중단되고 채널이 사용 가능한 상태가 되어 응답할 수 있게 됩니다.

녹색 LED가 켜집니다.

2 다음 중 하나를 수행합니다.

- 통화 허용 신호음(활성화된 경우)이 끝날 때까지 기다렸다가 마이크에 대고 명확히 말합니다.
- **PTT** 사이드톤(활성화된 경우)이 끝날 때까지 기다렸다가 마이크에 대고 또렷하게 말합니다.

3 상대방의 말을 들으려면 **PTT** 버튼을 놓습니다.

미리 정해진 시간 동안 음성 동작이 없으면 호출이 종료됩니다.

브로드캐스트 호출

브로드캐스트 호출은 모든 사용자에서 전체 통화 그룹으로의 단방향 음성 호출입니다.

브로드캐스트 호출 기능을 사용하면 호출 발신 사용자는 통화 그룹에 전송만 할 수 있으며 호출 수신자가 응답할 수 없습니다.

브로드캐스트 게시자는 브로드캐스트 호출을 종료할 수도 있습니다. 그룹 사용자로부터 호출을 수신하거나 그룹 사용자를 호출하려면 무전기가 해당 그룹의 일부로 구성되어야 합니다.

브로드캐스트 호출 전송

다음 절차에 따라 무전기에서 브로드캐스트 호출을 전송합니다.

1 다음 중 하나를 수행합니다.

- 활성 그룹 별칭 또는 ID가 있는 채널을 선택합니다. [호출 유형 선택 페이지의 55](#)을 참조하십시오.
- 프로그래밍된 **원터치 액세스** 버튼을 누릅니다.

2 PTT 버튼을 눌러 전화를 전송합니다.

녹색 LED가 켜집니다. 디스플레이에 **그룹 호출** 아이콘과 별칭이 표시됩니다.

3 다음 중 하나를 수행합니다.



- 통화 허용 신호음(활성화된 경우)이 끝날 때까지 기다렸다가 마이크에 대고 명확히 말합니다.
- **PTT** 사이드톤(활성화된 경우)이 끝날 때까지 기다렸다가 마이크에 대고 또렷하게 말합니다.

호출 발신자는  버튼을 눌러 브로드캐스트 호출을 종료할 수 있습니다.



연락처 목록을 사용하여 브로드캐스트 호출 전송

다음 절차에 따라 연락처 목록을 사용하여 무전기에서 브로드캐스트 호출을 전송합니다.

1  버튼을 눌러 메뉴로 이동합니다.

2  또는  버튼을 눌러 연락처로 이동합니다.

 버튼을 눌러 선택합니다.

3  또는  버튼을 눌러 원하는 별칭 또는 ID로 이동합니다.  버튼을 눌러 선택합니다.

4 PTT 버튼을 눌러 전화를 전송합니다.

녹색 LED가 깜박입니다.

첫 번째 줄에 가입자 별칭 또는 ID가 표시됩니다. 두 번째 줄에는 그룹 호출과 **그룹 호출** 아이콘이 표시됩니다.

5 다음 중 하나를 수행합니다.

- 통화 허용 신호음(활성화된 경우)이 끝날 때까지 기다렸다가 마이크에 대고 명확히 말합니다.
- **PTT** 사이드톤(활성화된 경우)이 끝날 때까지 기다렸다가 마이크에 대고 또렷하게 말합니다.

호출 발신자는  버튼을 눌러 브로드캐스트 호출을 종료할 수 있습니다.

프로그래밍 가능 숫자 키로 브로드캐스트 호출 전송

다음 절차에 따라 프로그래밍 가능한 숫자 키를 사용하여 무전기에서 브로드캐스트 호출을 전송합니다.

- 1 홈 화면에 있는 경우 프로그래밍된 숫자 키를 길게 눌러 미리 정의된 별칭이나 ID로 이동합니다.

특정 모드에서 항목에 숫자 키를 지정할 경우 다른 모드에서 숫자 키를 길게 누르면 이 기능이 지원되지 않습니다.

항목에 숫자 키가 연결되어 있지 않으면 해제음이 울립니다.

- 2 PTT 버튼을 눌러 전화를 전송합니다.

녹색 LED가 켜집니다. 디스플레이의 오른쪽 상단에 그룹 호출 아이콘이 표시됩니다. 첫 번째 텍스트 줄에 발신자 별칭이 표시됩니다.

- 3 다음 중 하나를 수행합니다.

- 통화 허용 신호음(활성화된 경우)이 끝날 때까지 기다렸다가 마이크에 대고 명확히 말합니다.
- PTT 사이드톤(활성화된 경우)이 끝날 때까지 기다렸다가 마이크에 대고 또렷하게 말합니다.

호출 발신자는  버튼을 눌러 브로드캐스트 호출을 종료할 수 있습니다.

브로드캐스트 호출 수신

다음 절차에 따라 무전기에 브로드캐스트 호출을 수신합니다.

브로드캐스트 호출 수신 시:

- 녹색 LED가 깜박입니다.
- 디스플레이의 오른쪽 상단에 그룹 호출 아이콘이 표시됩니다.
- 첫 번째 텍스트 줄에 발신자 별칭이 표시됩니다.
- 두 번째 텍스트 줄에 그룹 호출 별칭이 표시됩니다.
- 무전기 음소거가 해제되고 호출 수신 시 스피커를 통해 소리가 납니다.

**주의:**

수신 사용자는 브로드캐스트 호출 도중 토크백할 수 없습니다. 디스플레이에 토크백 금지가 표시됩니다. 브로드캐스트 호출 도중 **PTT** 버튼을 누르면 토크백 금지 신호음을 잠시 들을 수 있습니다.

개별 호출

개별 호출은 개별 무전기 간 호출을 말합니다.

개별 호출은 두 가지 방법으로 설정할 수 있습니다.

- 첫 번째 호출 유형은 OACSU(Off Air Call Set-Up)라고 합니다. OACSU는 무전기 존재를 확인한 후에 호출을 설정하고 자동으로 호출을 완료합니다.
- 두 번째 유형은 FOACSU(Full Off Air Call Set-Up)라고 합니다. FOACSU도 무전기 존재를 확인한 후에 호출을 설정합니다. 그러나 FOACSU 호출에서 호출을 완료하려면 사용자의 승인이 필요하고 사용자가 호출을 승인하거나 거부할 수 있습니다.

호출 유형은 시스템 관리자가 구성합니다.

**주의:**

호출 발신자와 수신자 모두  버튼을 눌러 진행 중인 개별 호출을 종료할 수 있습니다.

개별 호출 전송

개별 호출을 시작하려면 무전기가 프로그래밍되어야 합니다. 이 기능이 활성화되어 있지 않을 경우 호출을 시작할 때 해제음이 울립니다. 다음 절차에 따라 무전기에서 개별 호출을 전송합니다. 대상 무전기를 사용할 수 없으면 짧은 톤이 울리고 디스플레이에 호출을 받을 수 없음이 표시됩니다.

- 1 다음 중 하나를 수행합니다.
 - 가입자 별칭 또는 ID가 활성화되어 있는 채널을 선택합니다. [호출 유형 선택 페이지의 55](#)을 참조하십시오.
 - 프로그래밍된 **원터치 액세스** 버튼을 누릅니다.
- 2 **PTT** 버튼을 눌러 전화를 전송합니다.
녹색 LED가 켜집니다. 디스플레이에 **개별 호출** 아이콘, 가입자 별칭과 호출 상태가 표시됩니다.
- 3 통화 허용 신호음(활성화된 경우)이 끝날 때까지 기다렸다가 마이크에 대고 명확히 말합니다.
- 4 상대방의 말을 들으려면 **PTT** 버튼을 놓습니다.
대상 무전기가 응답하면 녹색 LED가 켜집니다.

- 5 미리 정해진 시간 동안 음성 동작이 없으면 호출이 종료됩니다. 짧은 신호음이 울립니다. 디스플레이에 호출 종료가 표시됩니다.

호출 발신자와 수신자 모두  버튼을 눌러 진행 중인 개별 호출을 종료할 수 있습니다.

발신자 별칭이 표시됩니다. 두 번째 텍스트 줄에 통화 상태가 표시됩니다.

- 3 상대방의 말을 들으려면 **PTT** 버튼을 놓습니다. 대상 무전기가 응답하면 녹색 **LED**가 깜박입니다. 디스플레이에 대상 별칭이 표시됩니다.

- 4 미리 정해진 시간 동안 음성 동작이 없으면 호출이 종료됩니다. 짧은 신호음이 울립니다. 디스플레이에 통화 종료가 표시됩니다.

호출 발신자와 수신자 모두  버튼을 눌러 진행 중인 개별 호출을 종료할 수 있습니다.

자세한 내용은 [프로그래밍 가능 숫자 키에 항목 할당 페이지의 383](#) 부분을 참조하십시오.

별칭 검색을 사용하여 개별 호출 전송

- 1  버튼을 눌러 메뉴로 이동합니다.

프로그래밍 가능 숫자 키를 사용하여 개별 호출 전송

다음 절차에 따라 프로그래밍 가능한 숫자 키를 사용하여 무전기에서 개별 호출을 전송합니다.



- 1 홈 화면에 있는 경우 프로그래밍된 숫자 키를 길게 눌러 미리 정의된 별칭이나 ID로 이동합니다.

특정 모드에서 항목에 숫자 키를 지정할 경우 다른 모드에서 숫자 키를 길게 누르면 이 기능이 지원되지 않습니다.

항목에 숫자 키가 연결되어 있지 않으면 해제음이 울립니다.



- 2 **PTT** 버튼을 눌러 전화를 전송합니다.

녹색 **LED**가 켜집니다. 디스플레이의 오른쪽 상단에 **개별 호출** 아이콘이 표시됩니다. 첫 번째 텍스트 줄에





2  또는  버튼을 눌러 연락처로 이동합니다.

 버튼을 눌러 선택합니다.

디스플레이에 항목이 알파벳 순으로 표시됩니다.

3  또는  을 눌러 원하는 가입자 별칭 또는 ID 로 이동합니다. 디스플레이의 첫 번째 줄에 전화 번호:가 표시됩니다. 디스플레이의 두 번째 줄에 커서 가 깜박입니다. 키패드로 전화 번호를 입력합니다.

4  버튼을 눌러 선택합니다. 선택한 항목이 비어 있으면 해제음이 울리고 디스플레이에 잘못된 전화 번호가 표시됩니다.



5  또는  을 눌러 전화 연결 통화 및  버튼을 눌러 선택합니다.로 이동합니다. 연락처 목록에 액세스 코드가 사전 구성되어 있지 않은 경우 디스플레이의 첫 번째 줄에 액세스 코드:가 표시됩니다. 디스플레이의 두 번째 줄에 커서가 깜박입니다. 액세스 코드를 입력하고  버튼을 눌러 계속합니다. 성공하면 DTMF 톤이 울립니다. 전화기 사용자의 발신음이 들립니다. 디스플레이의 첫 번째 줄에 가입자 별칭 또는 ID, **RSSI** 아이콘이 표시됩니다. 디스플레이의

두 번째 줄에 전화 및 **전화** 아이콘이 표시됩니다. 실패하면 톤이 울리고 디스플레이에 전화 접속 통화 실패가 표시됩니다. 무전기가 액세스 코드 입력 화면으로 돌아갑니다. 연락처 목록에 액세스 코드가 사전 구성되어 있는 경우 무전기가 호출을 시작하기 전에 있었던 화면으로 돌아갑니다.

6 말을 하려면 **PTT** 버튼을 누르고, 상대방의 말을 들으려면 **PTT** 버튼을 놓습니다. 전송 중에는 **RSSI** 아이콘이 사라집니다.

7 추가 숫자를 입력하려면, 전화로 요청된 경우 다음 중 하나를 수행합니다.

- 아무 키패드 키를 눌러 추가 숫자 입력을 시작합니다. 디스플레이의 첫 번째 줄에 추가 숫자:가 표시됩니다. 디스플레이의 두 번째 줄에 커서가 깜박입니다. 추가 숫자를 입력하고  버튼을 눌러 계속합니다. DTMF 톤이 울리고 무전기가 이전 화면으로 돌아갑니다.
- **원터치 액세스** 버튼을 누릅니다. DTMF 톤이 울립니다. **원터치 액세스** 버튼 항목이 비어 있으면 해제음이 울립니다.



- 8  버튼을 눌러 통화를 종료합니다. 연락처 목록에 액세스 해제 코드가 사전 구성되어 있지 않은 경우 디스플레이의 첫 번째 줄에 액세스 해제 코드:가 표시됩니다. 디스플레이의 두 번째 줄에 커서가 깜박입니다. 액세스 해제 코드를 입력하고  버튼을 눌러 계속합니다. 무전기가 이전 화면으로 돌아갑니다. DTMF 톤이 울리고 디스플레이에 전화 종료 중이 표시됩니다. 성공하면 신호음이 울리고 디스플레이에 전화 종료가 표시됩니다. 무전기가 전화 화면으로 돌아갑니다. 실패하면 무전기가 전화 화면으로 돌아갑니다. 전화 연락처 화면에서 **PTT** 버튼을 누르면 톤이 울리고 디스플레이에 통화 시도 시 'OK'를 누르시오가 표시됩니다. 전화기 사용자가 통화를 종료하면 톤이 울리고 디스플레이에 전화 종료가 표시됩니다. 호출에 필요한 숫자를 추가로 입력하는 동안 호출을 종료하면 무전기가 호출 시작 전 화면으로 돌아갑니다.

- 9 미리 정해진 시간 동안 음성 동작이 없으면 호출이 종료됩니다. 짧은 신호음이 울립니다. 디스플레이에 통화 종료가 표시됩니다.

호출 발신자와 수신자 모두  버튼을 눌러 진행 중인 개별 호출을 종료할 수 있습니다.



주의:

채널 액세스 동안  을 눌러 호출 시도를 취소하면 신호음이 울립니다. 또는 별칭 검색을 종료합니다.  또는  버튼을 눌러 별칭 검색을 종료합니다. 액세스 해제 코드가 미리 구성된 상태에서 호출 중에 **원터치 액세스** 버튼을 누르거나, 추가 숫자 입력 시 액세스 해제 코드를 입력하면 무전기에서 호출 종료를 시도합니다.

원터치 호출 버튼으로 개별 호출 전송

원터치 호출 기능을 사용하면 미리 정의된 개별 호출 별칭 또는 ID로 개별 호출을 쉽게 할 수 있습니다. 이 기능은 프로그램 가능 버튼에 짧게 누름이나 길게 누름으로 할당할 수 있습니다.

원터치 호출 버튼에는 하나의 별칭 또는 ID만 할당할 수 있습니다. 무전기에 여러 개의 원터치 호출 버튼을 프로그래밍할 수 있습니다.

- 1 프로그래밍된 **원터치 호출** 버튼을 눌러 미리 정의된 개별 호출 별칭 또는 ID에 개별 호출을 전송합니다.
- 2 **PTT** 버튼을 눌러 전화를 전송합니다.
녹색 LED가 켜집니다.

디스플레이에 개별 호출 별칭 또는 ID가 표시됩니다.

3 통화 허용 경보음(활성화된 경우)이 끝날 때까지 기다렸다가 마이크에 대고 명확히 말합니다.

4 상대방의 말을 들으려면 **PTT** 버튼을 놓습니다.

대상 무전기에서 응답하면 **LED**가 녹색으로 깜박입니다.



미리 정해진 시간 동안 음성 동작이 없으면 호출이 종료됩니다.

호출 발신자와 수신자 모두  버튼을 눌러 진행 중인 개별 호출을 종료할 수 있습니다.



매뉴얼 다이얼을 사용하여 개별 호출 전송

다음 절차에 따라 매뉴얼 다이얼을 사용하여 무전기에서 개별 호출을 전송합니다.



1  버튼을 눌러 메뉴로 이동합니다.

2  또는  버튼을 눌러 연락처로 이동합니다.

 버튼을 눌러 선택합니다.



3  또는  버튼을 눌러 매뉴얼 다이얼로 이동합니다.

 버튼을 눌러 선택합니다.

4  또는  버튼을 눌러 무전기 번호를 선택합니다.

 버튼을 눌러 선택합니다.

5 다음 중 하나를 수행합니다.

- 가입자 ID를 입력하고  버튼을 눌러 계속합니다.
- 이전에 연결했던 가입자 ID를 편집하고  버튼을 눌러 계속합니다.

6 **PTT** 버튼을 눌러 전화를 전송합니다.

녹색 **LED**가 켜집니다. 디스플레이에 대상 별칭이 표시됩니다.

7 통화 허용 신호음(활성화된 경우)이 끝날 때까지 기다렸다가 마이크에 대고 명확히 말합니다.

8 상대방의 말을 들으려면 **PTT** 버튼을 놓습니다.

대상 무전기가 응답하면 녹색 LED가 켜집니다. 디스플레이에 전송 중인 사용자 별칭 또는 ID가 표시됩니다.

9 채널 프리 표시 기능이 활성화된 경우 발신 무전기에서 **PTT** 버튼을 놓으면 채널이 사용 가능하여 응답할 수 있음을 나타내는 짧은 경보음이 울립니다. **PTT** 버튼을 눌러 호출에 응답합니다.

미리 정해진 시간 동안 음성 동작이 없으면 호출이 종료됩니다. 신호음이 울립니다. 디스플레이에 통화 종료 표시가 표시됩니다.

호출 발신자와 수신자 모두  버튼을 눌러 진행 중인 개별 호출을 종료할 수 있습니다.

개별 호출 수신

OACSU(Off Air Call Set-Up)로 구성된 개별 호출을 수신한 경우:

- 녹색 LED가 깜박입니다.

- 무전기 음소거가 해제되고 호출 수신 시 스피커를 통해 소리가 납니다.



주의:

무전기가 OACSU 또는 FOACSU(Full Off Air Call Set-Up)로 구성되는 방식에 따라 개별 호출에 응답하는 사용자 승인이 필요한지 여부를 알 수 있습니다.



OACSU 구성의 경우 무전기의 음소거가 해제되고 호출이 자동으로 연결됩니다.

개별 호출 수락하기

FOACSU(Full Off Air Call Set-Up)로 구성된 개별 호출을 수신하는 경우:

- 녹색 LED가 깜박입니다.

1 FOACSU로 구성된 개별 호출을 수락하려면 다음 중 하나를 수행합니다.

-  또는  을 눌러 수락하고  을 눌러 개별 호출에 응답합니다.

- 아무 항목에서 **PTT** 버튼을 누릅니다.

녹색 LED가 켜집니다.

2 통화 허용 신호음(활성화된 경우)이 끝날 때까지 기다렸다가 마이크에 대고 명확히 말합니다.

3 상대방의 말을 들으려면 **PTT** 버튼을 놓습니다.

미리 정해진 시간 동안 음성 동작이 없으면 호출이 종료됩니다. 신호음이 울립니다. 디스플레이에 통화 종료 표시가 표시됩니다.



주의:

호출 발신자와 수신자 모두  버튼을 눌러 진행 중인 개별 호출을 종료할 수 있습니다.

-  을 눌러 개별 호출을 거절합니다.

전체 호출

전체 호출은 시스템 구성에 따라 개별 무전기와 사이트의 모든 무전기 또는 사이트 그룹의 모든 무전기 간의 호출을 의미합니다.

전체 호출은 사용자의 주의가 필요한 중요 정보를 통보하는데 사용됩니다. 시스템상의 사용자는 전체 호출에 응답할 수 없습니다.

Capacity Max는 사이트 전체 호출 및 다중 사이트 전체 호출을 지원합니다. 시스템 관리자가 무전기에서 하나 또는 모두를 구성할 수 있습니다.



주의:

가입자는 시스템 전체 호출을 지원할 수 있지만 **Motorola Solutions** 인프라는 시스템 전체 호출을 지원하지 않습니다.

전체 호출 전송



전체 호출을 전송하려면 무전기가 프로그래밍되어야 합니다. 다음 절차에 따라 무전기에서 전체 호출을 전송합니다.

개별 호출 거부하기

FOACSU(Full Off Air Call Set-Up)로 구성된 개별 호출을 수신하는 경우:

- 녹색 LED가 깜박입니다.

FOACSU로 구성된 개별 호출을 거부하려면 다음 중 하나를 수행합니다.

-  또는  을 눌러 거부하고  버튼을 눌러 개별 호출을 거절합니다.

1 전체 호출 그룹 별칭 또는 ID가 활성화되어 있는 채널을 선택합니다. **호출 유형 선택 페이지의 55**을 참조하십시오.

2 **PTT** 버튼을 눌러 전화를 전송합니다.

녹색 **LED**가 켜집니다. 디스플레이에 **그룹 호출** 아이콘과 구성 유형에 따라 전체 호출, 사이트 전체 호출 또는 다중사이트 호출이 표시됩니다.

3 다음 중 하나를 수행합니다.

- 통화 허용 신호음(활성화된 경우)이 끝날 때까지 기다렸다가 마이크에 대고 명확히 말합니다.
- **PTT** 사이드톤(활성화된 경우)이 끝날 때까지 기다렸다가 마이크에 대고 또렷하게 말합니다.

채널 상의 사용자는 전체 호출에 응답할 수 없습니다.

호출 발신자는 **(5^)** 버튼을 눌러 전체 호출을 종료할 수 있습니다.

프로그래밍 가능 숫자 키를 사용하여 전체 호출 전송

다음 절차에 따라 프로그래밍 가능한 숫자 키를 사용하여 무전기에서 전체 호출을 전송합니다.

1 홈 화면에 있는 경우 프로그래밍된 숫자 키를 길게 누르면 미리 정의된 별칭이나 ID로 할당됩니다.

특정 모드에서 항목에 숫자 키를 지정할 경우 다른 모드에서 숫자 키를 길게 누르면 이 기능이 지원되지 않습니다.

항목에 숫자 키가 연결되어 있지 않으면 해제음이 울립니다.

2 **PTT** 버튼을 눌러 전화를 전송합니다.

녹색 **LED**가 켜집니다. 디스플레이에 **그룹 호출** 아이콘과 구성 유형에 따라 전체 호출, 사이트 전체 호출 또는 다중 사이트 호출이 표시됩니다.

3 다음 중 하나를 수행합니다.



- 통화 허용 신호음(활성화된 경우)이 끝날 때까지 기다렸다가 마이크에 대고 명확히 말합니다.
- **PTT** 사이드톤(활성화된 경우)이 끝날 때까지 기다렸다가 마이크에 대고 또렷하게 말합니다.



호출 발신자는 **(5^)** 버튼을 눌러 전체 호출을 종료할 수 있습니다.

자세한 내용은 **프로그래밍 가능 숫자 키에 항목 할당 페이지의 383** 부분을 참조하십시오.



별칭 검색을 사용하여 전체 호출 전송

- 1  버튼을 눌러 메뉴로 이동합니다.

- 2  또는  버튼을 눌러 연락처로 이동합니다.
 버튼을 눌러 선택합니다.
디스플레이에 항목이 알파벳 순으로 표시됩니다.

- 3  또는  을 눌러 원하는 가입자 별칭 또는 ID 로 이동합니다. 디스플레이의 첫 번째 줄에 전화 번호:가 표시됩니다. 디스플레이의 두 번째 줄에 커서가 깜박입니다. 키패드로 전화 번호를 입력합니다.

- 4  버튼을 눌러 선택합니다. 선택한 항목이 비어 있으면 해제음이 울리고 디스플레이에 잘못된 전화 번호가 표시됩니다.



- 5  또는  버튼을 눌러 전화 통화로 이동합니다.  버튼을 눌러 선택합니다. |연락처 목록에 액세스 코드가 사전 구성되어 있지 않은 경우, 디스플레이의 첫 번째 줄에 액세스 코드:가 표시됩니다. 디스

플레이의 두 번째 줄에 커서가 깜박입니다. 액세스 코드를 입력하고  버튼을 눌러 계속합니다. 성공하면 DTMF 톤이 울립니다. 전화기 사용자의 발신음이 들립니다. 디스플레이의 첫 번째 줄에 가입자 별칭 또는 ID, RSSI 아이콘이 표시됩니다. 디스플레이의 두 번째 줄에 전화 및 전화 아이콘이 표시됩니다. 실패하면 톤이 울리고 디스플레이에 전화 접속 통화 실패가 표시됩니다. 무전기가 액세스 코드 입력 화면으로 돌아갑니다. 연락처 목록에 액세스 코드가 사전 구성되어 있는 경우 무전기가 호출을 시작하기 전에 있었던 화면으로 돌아갑니다.

- 6 말을 하려면 **PTT** 버튼을 누르고, 상대방의 말을 들려면 **PTT** 버튼을 놓습니다. 전송 중에는 **RSSI** 아이콘이 사라집니다.

- 7 추가 숫자를 입력하려면, 전화로 요청된 경우 다음 중 하나를 수행합니다.
 - 아무 키패드 키를 눌러 추가 숫자 입력을 시작합니다. 디스플레이의 첫 번째 줄에 추가 숫자:가 표시됩니다. 디스플레이의 두 번째 줄에 커서가 깜박입니다. 추가 숫자를 입력하고  버튼을 눌러 계속합니다. DTMF 톤이 울리고 무전기가 이전 화면으로 돌아갑니다.

- 원터치 액세스 버튼을 누릅니다. DTMF 톤이 울립니다. 원터치 액세스 버튼 항목이 비어 있으면 해제음이 울립니다.

- 8  버튼을 눌러 통화를 종료합니다. 연락처 목록에 액세스 해제 코드가 사전 구성되어 있지 않은 경우 디스플레이의 첫 번째 줄에 액세스 해제 코드:가 표시됩니다. 디스플레이의 두 번째 줄에 커서가 깜박입니다. 액세스 해제 코드를 입력하고  버튼을 눌러 계속합니다. 무전기가 이전 화면으로 돌아갑니다. DTMF 톤이 울리고 디스플레이에 전화 종료 중이 표시됩니다. 성공하면 톤이 울리고 디스플레이에 전화 종료가 표시됩니다. 무전기가 전화 화면으로 돌아갑니다. 실패하면 무전기가 전화 화면으로 돌아갑니다. 전화 연락처 화면에서 **PTT** 버튼을 누르면 톤이 울리고 디스플레이에 통화 시도 시 'OK'를 누르시오가 표시됩니다. 전화기 사용자가 통화를 종료하면 톤이 울리고 디스플레이에 전화 종료가 표시됩니다. 전화에 필요한 숫자를 추가로 입력하는 동안 통화를 종료하면 무전기가 호출 시작 전 화면으로 돌아갑니다.



주의:

호출 발신자는  버튼을 눌러 전체 호출을 종료할 수 있습니다.

전체 호출 수신

전체 호출 수신 시 다음과 같은 상황이 발생합니다.

- 신호음이 울립니다.
- 녹색 LED가 깜박입니다.
- 디스플레이의 오른쪽 상단에 **그룹 호출** 아이콘이 표시됩니다.
- 첫 번째 텍스트 줄에 발신자 별칭 ID가 표시됩니다.
- 두 번째 텍스트 줄에는 구성 유형에 따라 전체 호출, 사이트 전체 호출 또는 다중 사이트 호출이 표시됩니다.
- 무전기 음소거가 해제되고 호출 수신 시 스피커를 통해 소리가 납니다.

호출을 종료하면 무전기가 전체 호출을 수신하기 전 화면으로 돌아갑니다.

가용 채널 표시 기능이 활성화된 경우 발신 무전기에서 **PTT** 버튼을 놓으면 채널이 사용 가능성을 나타내는 짧은 경보음이 울립니다. 전체 호출에는 응답할 수 없습니다.



주의:

무전기에서 호출을 수신하는 동안 다른 채널로 전환하는 경우에는 전체 호출 수신이 중지됩니다. 전체 호출 중에는 호출이 끝날 때까지 메뉴 탐색이나 편집을 계속할 수 없습니다.

전화 통화

전화 통화는 개별 무전기 또는 무전기 그룹과 전화 사이의 통화입니다.

무전기 구성 방법에 따라 다음과 같은 기능을 사용할 수도 있고 사용하지 못할 수도 있습니다.

- 이중 신호음 다중 주파수(DTMF) 신호음
- 액세스 해제 코드
- 전화 통화 수신 시 발신자 별칭 또는 ID 표시
- 전화 통화를 거부하거나 수락할 수 있는 기능

전화 통화 기능은 시스템에 전화 번호를 지정하고 설정하여 활성화할 수 있습니다. 무전기가 프로그래밍된 방식에 대해서는 시스템 관리자에게 문의하십시오.

전화 송신

다음 절차에 따라 무전기에서 전화를 전송합니다.

- 1 프로그래밍된 **원터치 액세스** 버튼을 눌러 미리 정의된 별칭 또는 ID로 이동합니다.
원터치 액세스 버튼 항목이 비어 있으면 해제음이 울립니다.

연락처 목록에서 액세스 코드가 미리 구성되지 않은 경우 디스플레이에 액세스 코드:가 표시됩니다.

- 2 액세스 코드를 입력하고  버튼을 눌러 계속합니다.
액세스 코드 또는 액세스 해제 코드는 10자 이내여야 합니다.

- 3 **PTT** 버튼을 눌러 호출에 응답합니다.

- 4 상대방의 말을 들으려면 **PTT** 버튼을 놓습니다.

- 5 요청 메시지가 표시된 경우 키패드로 추가 숫자를 입력하고  버튼을 눌러 계속합니다.

호출에 필요한 숫자를 추가로 입력하는 동안 호출을 종료하면 무전기가 호출 시작 전 화면으로 돌아갑니다.

DTMF 톤이 울립니다. 무전기가 이전 화면으로 돌아갑니다.

- 6  버튼을 눌러 통화를 종료합니다.

- 7 다음 중 하나를 수행합니다.

- 액세스 해제 코드가 사전 구성되어 있지 않은 경우 디스플레이에 액세스 해제 코드:가 표시되면 액세스 해제 코드를 입력하고  버튼을 눌러 계속합니다. 무전기가 이전 화면으로 돌아갑니다.
- 프로그래밍된 **원터치 액세스** 버튼을 누릅니다. **원터치 액세스** 버튼 항목이 비어 있으면 해제음이 울립니다.

DTMF 톤이 울리고 디스플레이에 전화 통화 종료 중이 표시됩니다.

통화를 성공적으로 종료한 경우:



- 신호음이 울립니다.
- 디스플레이에 통화 종료가 표시됩니다.

통화 종료에 실패하면 무전기가 전화 통화 화면으로 돌아갑니다. 마지막 두 단계를 반복하거나 전화기 사용자가 통화를 종료할 때까지 기다립니다.

프로그래밍 가능 버튼을 사용하여 전화 송신

다음 절차에 따라 프로그래밍 가능 버튼을 사용하여 전화를 송신합니다.

1 프로그래밍된 **전화** 버튼을 눌러 전화 항목 목록으로 들어갑니다.

2  또는  버튼을 눌러 원하는 별칭 또는 ID로 이동합니다.  버튼을 눌러 선택합니다.

연락처 목록에서 액세스 코드가 미리 구성되지 않은 경우 디스플레이에 액세스 코드:가 표시됩니다. 액세스 코드를 입력하고  버튼을 눌러 계속합니다. 녹색 LED가 켜집니다. 디스플레이에 **전화 통화** 아이콘, 가입자 별칭 또는 ID 및 호출 상태가 표시됩니다.

호출 설정에 성공한 경우:

- DTMF 톤이 울립니다.
- 전화기 사용자의 통화 대기음이 들립니다.
- 디스플레이에 **전화 통화** 아이콘, 가입자 별칭 또는 ID, 전화 통화, 호출 상태가 표시됩니다.

호출 설정에 실패한 경우:

- 신호음이 울립니다.
- 디스플레이에 전화 통화 실패가 표시됩니다.
- 무전기가 액세스 코드 입력 화면으로 돌아갑니다. 연락처 목록에 액세스 코드가 사전 구성되어 있는

경우 무전기가 호출을 시작하기 전에 있었던 화면으로 돌아갑니다.

3 PTT 버튼을 눌러 응답합니다. 상대방의 말을 들으려면 **PTT** 버튼을 놓습니다. 전송 중에는 **RSSI** 아이콘이 사라집니다.

4 전화 통화 시 추가 숫자 입력이 요청된 경우: 다음 중 하나를 수행합니다.

- 아무 키패드 키를 눌러 추가 숫자 입력을 시작합니다. 디스플레이에 추가 숫자:가 표시되며 커서가 깜박입니다. 추가 숫자를 입력하고  버튼을 눌러 계속합니다. **DTMF** 톤이 울리고 무전기가 이전 화면으로 돌아갑니다.
- **원터치 액세스** 버튼을 누릅니다. **DTMF** 톤이 울립니다. **원터치 액세스** 버튼 항목이 비어 있으면 해제음이 울립니다.

5  버튼을 눌러 통화를 종료합니다.

연락처 목록에서 액세스 해제 코드가 사전 구성되지 않은 경우 디스플레이에 액세스 해제 코드:가 표시

됩니다. 액세스 해제 코드를 입력하고  버튼을 눌러 계속합니다.

DTMF 톤이 울리고 디스플레이에 전화 통화 종료 중이 표시됩니다.

호출 종료 설정에 성공하면 신호음이 울리고 디스플레이에 호출 종료:가 표시됩니다.

호출 종료 설정에 실패하면 무전기가 전화 화면으로 돌아갑니다.

전화 연락처 화면에서 **PTT** 버튼을 누르면 신호음이 울리고 디스플레이에 통화 시도 시 **OK**를 누르시오가 표시됩니다.

전화기 사용자가 통화를 종료하면 톤이 울리고 디스플레이에 전화 종료:가 표시됩니다.

전화에 필요한 숫자를 추가로 입력하는 동안 통화를 종료하면 무전기가 호출 시작 전 화면으로 돌아갑니다.

**주의:**

채널 액세스 동안  버튼을 눌러 호출 시도를 취소하면 신호음이 울립니다.



액세스 해제 코드가 미리 구성된 상태에서 호출 중에 **원터치 액세스** 버튼을 누르거나, 추가 숫자 입력 시 액세스 해제 코드를 입력하면 무전기에서 호출 종료를 시도합니다.

채널에 액세스하거나, 액세스/액세스 해제 코드를 입력하거나, 추가 숫자를 입력하는 중에는 무전기가 **켜기/끄기** 버튼, **볼륨 조정 볼륨 노브** 및 **채널 조정 채널 락커**에만 응답합니다. 이 외에 다른 잘못된 버튼을 누르면 톤이 울립니다.

연락처 목록을 사용하여 전화 송신



다음 절차에 따라 연락처 목록을 사용하여 무전기에서 전화를 전송합니다.

- 1  버튼을 눌러 메뉴로 이동합니다.

- 2  또는  버튼을 눌러 연락처로 이동합니다.

 버튼을 눌러 선택합니다.

디스플레이에 항목이 알파벳 순으로 표시됩니다.



- 3  또는  버튼을 눌러 원하는 별칭 또는 ID로 이동합니다.  버튼을 눌러 선택합니다.

전화 연락처 화면에서 **PTT** 버튼을 누르는 경우:

- 해제음이 울립니다.
- 디스플레이에 통화하려면 확인을 누르십시오라고 표시됩니다.

선택한 항목이 비어 있는 경우:

- 해제음이 울립니다.
- 디스플레이에 잘못된 전화 번호가 표시됩니다.

4  또는  버튼을 눌러 전화 통화로 이동합니다.

다.  버튼을 눌러 선택합니다.

액세스 코드가 사전 구성되어 있지 않은 경우 디스플레이에 액세스 코드:가 표시됩니다.

5 액세스 코드를 입력하고  버튼을 눌러 계속합니다.

액세스 코드 또는 액세스 해제 코드는 10자 이내여야 합니다.

디스플레이에 발신, 가입자 별칭 또는 ID 및 전화 통화 아이콘이 표시됩니다.

통화가 성공한 경우:

- DTMF 톤이 울립니다.
- 전화기 사용자의 통화 대기음이 들립니다.
- 디스플레이에 가입자 별칭 또는 ID, 전화 통화 아이콘과 전화 통화가 표시됩니다.

통화가 실패한 경우:

- 신호음이 울립니다.
- 디스플레이에 전화 통화 실패가 표시된 다음 액세스 코드:가 표시됩니다.

- 연락처 목록에 액세스 코드가 사전 구성되어 있는 경우 무전기가 통화를 시작하기 전에 있었던 화면으로 돌아갑니다.

6 PTT 버튼을 눌러 호출에 응답합니다.

RSSI 아이콘이 사라집니다.

7 상대방의 말을 들으려면 PTT 버튼을 놓습니다.

8 요청 메시지가 표시된 경우 키패드로 추가 숫자를 입력하고  버튼을 눌러 계속합니다.

통화에 필요한 숫자를 추가로 입력하는 동안 통화를 종료하면 무전기가 통화 시작 전 화면으로 돌아갑니다.

DTMF 톤이 울립니다. 무전기가 이전 화면으로 돌아갑니다.

9  버튼을 눌러 통화를 종료합니다.

10 액세스 해제 코드가 사전 구성되어 있지 않은 경우 디스플레이에 액세스 해제 코드:가 표시되면 액세스 해제 코드를 입력하고  버튼을 눌러 계속합니다. 무전기가 이전 화면으로 돌아갑니다. DTMF 톤이 울리고 디스플레이에 전화 통화 종료 중이 표시됩니다.

통화를 성공적으로 종료한 경우:

- 신호음이 울립니다.
- 디스플레이에 통화 종료가 표시됩니다.

통화 종료에 실패하면 무전기가 전화 통화 화면으로 돌아갑니다. **단계 9** 단계 및 **단계 10** 단계를 반복하거나 전화기 사용자가 통화를 종료할 때까지 기다립니다. 전화 연락처 화면에서 PTT 버튼을 누르면 신호음이 울리고 디스플레이에 통화하려면 OK를 누르십시오.

전화기 사용자가 통화를 종료하면 톤이 울리고 디스플레이에 전화 종료가 표시됩니다.

전화에 필요한 숫자를 추가로 입력하는 동안 통화를 종료하면 무전기가 호출 시작 전 화면으로 돌아갑니다.



주의:

채널 액세스 동안  을 눌러 호출 시도를 취소하면 신호음이 울립니다.

액세스 해제 코드가 미리 구성된 상태에서 호출 중에 **원터치 액세스** 버튼을 누르거나, 추가 숫자 입력 시 액세스 해제 코드를 입력하면 무전기에서 호출 종료를 시도합니다.



채널에 액세스하거나, 액세스/액세스 해제 코드를 입력하거나, 추가 숫자를 입력하는 중에는 무전기가 **켜기/끄기** 버튼, **볼륨 노브**, **채널 락커**에만 응답합니다. 이 외에 다른 잘못된 버튼을 누르면 톤이 울립니다.

별칭 검색을 사용하여 전화 송신

별칭이나 영숫자 검색을 사용하여 원하는 가입자 별칭을 검색할 수도 있습니다. 이 기능은 연락처에 있는 동안에만 사용할 수 있습니다. 다음 절차에 따라 별칭 검색을 사용하여 무전기에서 전화를 전송합니다.



1

 버튼을 눌러 메뉴로 이동합니다.



2  또는  버튼을 눌러 연락처로 이동합니다.

 버튼을 눌러 선택합니다.

디스플레이에 항목이 알파벳 순으로 표시됩니다.

3  또는  을 눌러 원하는 가입자 별칭 또는 ID 로 이동합니다.

4  버튼을 눌러 선택합니다. 선택한 항목이 비어 있으면 해제음이 울리고 디스플레이에 잘못된 전화 번호가 표시됩니다.

5  또는  버튼을 눌러 전화 통화로 이동합니

다.  버튼을 눌러 선택합니다.

연락처 목록에서 액세스 코드가 미리 구성되지 않은 경우 디스플레이에 액세스 코드:가 표시되고 커서가 깜박입니다. 액세스 코드를 입력하고  버튼을 눌러 계속합니다.

성공 시:

- DTMF 톤이 울립니다.
- 전화기 사용자의 통화 대기음이 들립니다.

- 디스플레이에 가입자 별칭 또는 ID, **RSSI** 아이콘, 전화 통화 및 **전화 통화** 아이콘이 표시됩니다.

실패 시:

- 신호음이 울립니다.
- 디스플레이에 전화 통화 실패가 표시됩니다.
- 무전기가 액세스 코드 입력 화면으로 돌아갑니다. 연락처 목록에 액세스 코드가 사전 구성되어 있는 경우 무전기가 호출을 시작하기 전에 있었던 화면으로 돌아갑니다.

6 말을 하려면 **PTT** 버튼을 누르고, 상대방의 말을 들으려면 **PTT** 버튼을 놓습니다. 전송 중에는 **RSSI** 아이콘이 사라집니다.

7 추가 숫자를 입력하려면, 전화로 요청된 경우 다음 중 하나를 수행합니다.

- 아무 키패드 키를 눌러 추가 숫자 입력을 시작합니다. 디스플레이에 추가 숫자:가 표시되며 커서가 깜박입니다. 추가 숫자를 입력하고  버튼을 눌러 계속합니다. DTMF 신호음
- 원터치 액세스 버튼을 누릅니다. DTMF 톤이 울립니다. 원터치 액세스 버튼 항목이 비어 있으면 해

제음이 울리고 무전기가 이전 화면으로 돌아갑니다.

8 버튼을 눌러 통화를 종료합니다.

연락처 목록에서 액세스 해제 코드가 사전 구성되지 않은 경우 디스플레이에 액세스 해제 코드:가 표시되고 커서가 깜박입니다. 액세스 해제 코드를 입력하고  버튼을 눌러 계속합니다.

무전기가 이전 화면으로 돌아갑니다. DTMF 톤이 울리고 디스플레이에 전화 종료 중이 표시됩니다.

성공 시:

- 신호음이 울립니다.
- 디스플레이에 전화 종료가 표시됩니다.
- 무전기가 전화 화면으로 돌아갑니다.



실패 시:

- 무전기가 전화 화면으로 돌아갑니다.
- 전화 연락처 화면에서 **PTT** 버튼을 누르면 톤이 울리고 디스플레이에 통화 시도 시 'OK'를 누르시오가 표시됩니다.
- 전화기 사용자가 통화를 종료하면 톤이 울리고 디스플레이에 전화 종료가 표시됩니다.

- 전화에 필요한 숫자를 추가로 입력하는 동안 통화를 종료하면 무전기가 호출 시작 전 화면으로 돌아갑니다.





주의:

채널 액세스 동안  을 눌러 호출 시도를 취소하면 신호음이 울립니다. 또는 별칭 검색을 종료합니다.  또는  버튼을 눌러 별칭 검색을 종료합니다. 액세스 해제 코드가 미리 구성된 상태에서 호출 중에 **원터치 액세스** 버튼을 누르거나, 추가 숫자 입력 시 액세스 해제 코드를 입력하면 무전기에서 호출 종료를 시도합니다. 채널에 액세스하거나, 액세스/액세스 해제 코드를 입력하거나, 추가 숫자를 입력하는 중에는 무전기가 켜기/끄기 버튼, 볼륨 노브, 채널 락커에만 응답합니다. 이 외에 다른 잘못된 버튼을 누르면 톤이 울립니다.



매뉴얼 다이얼을 사용하여 전화 송신

다음 절차에 따라 매뉴얼 다이얼을 사용하여 무전기에서 전화를 송신합니다.



-  버튼을 눌러 메뉴로 이동합니다.

2  또는  버튼을 눌러 연락처로 이동합니다.

 버튼을 눌러 선택합니다.

3  또는  버튼을 눌러 매뉴얼 다이얼로 이동

합니다.  버튼을 눌러 선택합니다.

4  또는  버튼을 눌러 전화 번호로 이동합니

다.  버튼을 눌러 선택합니다.

디스플레이에 번호:가 표시되며 커서가 깜박입니다.

5 전화 번호를 입력하고  버튼을 눌러 계속합니다.

액세스 코드가 사전 구성되어 있지 않은 경우 디스플레이에 액세스 코드:가 표시되며 커서가 깜박입니다.

6 액세스 코드를 입력하고  버튼을 눌러 계속합니

다. 액세스 코드 또는 액세스 해제 코드는 10자 이내 여야 합니다.

녹색 LED가 켜집니다. 디스플레이에 **전화 통화** 아이콘, 가입자 별칭 및 호출 상태가 표시됩니다.

통화가 성공한 경우:

- DTMF 톤이 울립니다.
- 전화기 사용자의 통화 대기음이 들립니다.
- 디스플레이에 가입자 별칭과 **전화 통화** 아이콘이 표시됩니다.

통화가 실패한 경우:

- 신호음이 울립니다.
 - 디스플레이에 전화 통화 실패가 표시된 다음 액세스 코드:가 표시됩니다.
 - 연락처 목록에 액세스 코드가 사전 구성되어 있는 경우 무전기가 통화 시작 전 화면으로 돌아갑니다.
-

7  버튼을 눌러 통화를 종료합니다.

8 다음 중 하나를 수행합니다.

- 액세스 해제 코드가 사전 구성되어 있지 않은 경우 디스플레이에 액세스 해제 코드:가 표시되면 액세스 해제 코드를 입력하고  버튼을 눌러 계속합니다. 무전기가 이전 화면으로 돌아갑니다.

- 프로그래밍된 **원터치 액세스** 버튼을 누릅니다. **원터치 액세스** 버튼 항목이 비어 있으면 해제음이 울립니다.

DTMF 톤이 울리고 디스플레이에 전화 통화 종료 중이 표시됩니다.

통화를 성공적으로 종료한 경우:

- 신호음이 울립니다.
- 디스플레이에 통화 종료가 표시됩니다.

통화 종료에 실패하면 무전기가 전화 통화 화면으로 돌아갑니다. **단계 7**을(를) 반복하여 호출을 종료합니다.



주의:

전화 연락처 화면에서 **PTT** 버튼을 누르면 톤이 울리고 디스플레이에 통화 시도 시 'OK'를 누르시오가 표시됩니다.

전화기 사용자가 통화를 종료하면 톤이 울리고 디스플레이에 호출 종료가 표시됩니다.

호출에 필요한 숫자를 추가로 입력하는 동안 호출을 종료하면 무전기가 호출 시작 전 화면으로 돌아갑니다.

채널 액세스 동안  을 눌러 호출 시도를 취소하면 신호음이 울립니다.

액세스 해제 코드가 미리 구성된 상태에서 호출 중에 **원터치 액세스** 버튼을 누르거나, 추가 숫자 입력 시 액세스 해제 코드를 입력하면 무전기에서 호출 종료를 시도합니다.

채널에 액세스하거나, 액세스/액세스 해제 코드를 입력하거나, 추가 숫자를 입력하는 중에는 무전기가 **켜기/끄기** 버튼, **블륨 노브**, **채널 락키**에만 응답합니다. 이 외에 다른 잘못된 버튼을 누르면 톤이 울립니다.

이중 신호음 다중 주파수(DTMF)

이중 톤 다중 주파수(DTMF) 기능을 사용하면 무전기 시스템에서 인터페이스를 전화 시스템에 연결해 무전기를 작동할 수 있습니다.



모든 무전기 톤과 경보를 비활성화하여 DTMF 톤을 끌 수 있습니다. 자세한 내용은 [무전기 신호음/경보 켜기 또는 끄기 페이지의 188](#) 부분을 참조하십시오.

DTMF 호출 시작

다음 절차에 따라 무전기에서 DTMF 호출을 시작합니다.

1 PTT 버튼을 길게 누릅니다.

2 다음 중 하나를 수행합니다.

- 원하는 번호를 입력하여 DTMF 호출을 시작하십시오.
-  을 눌러 DTMF 호출을 시작하십시오.
-  을 눌러 DTMF 호출을 시작하십시오.

전체 호출로 전화 통화에 응답

전체 호출로 전화 통화를 수신하면 수신 중인 무전기는 톤백 또는 응답할 수 없습니다. 수신 사용자도 전체 호출을 종료할 수 없습니다.

전체 호출로 전화 통화를 수신한 경우:

- 디스플레이 오른쪽 상단에 **통화** 아이콘이 표시됩니다.
- 디스플레이에 구성 유형에 따라 전체 호출, 사이트 전체 호출 또는 다중 사이트 호출과 전화가 표시됩니다.
- 녹색 LED가 깜박입니다.
- 무전기 음소거가 해제되고 호출 수신 시 스피커를 통해 소리가 납니다.

그룹 호출로 전화 통화에 응답

다음 절차에 따라 무전기에서 그룹 호출로 전화 통화에 응답합니다.

그룹 호출로 전화 통화를 수신한 경우:

- 디스플레이에 **전화 통화** 아이콘과 전화 통화가 표시됩니다.
- 녹색 LED가 깜박입니다.

- 무전기 음소거가 해제되고 호출 수신 시 스피커를 통해 소리가 납니다.

1 PTT 버튼을 눌러 호출에 응답합니다.

2 상대방의 말을 들으려면 **PTT** 버튼을 놓습니다.

3  버튼을 눌러 통화를 종료합니다.



주의:

무전기가 그룹 호출로 전화 통화를 종료할 수 없습니다. 전화 사용자가 통화를 종료해야 합니다. 수신 사용자의 경우 통화 도중 응답만 허용됩니다.

디스플레이에 전화 통화 종료 중이 표시됩니다. 통화를 성공적으로 종료한 경우:

- 신호음이 울립니다.
- 디스플레이에 통화 종료가 표시됩니다.

통화 종료에 실패하면 무전기가 전화 통화 화면으로 돌아갑니다. **단계 3**을(를) 반복하여 호출을 종료합니다.

개별 호출로 전화 통화에 응답

다음 절차에 따라 무전기에서 개별 호출로 전화 통화에 응답합니다.

개별 호출로 전화 통화를 수신한 경우:

- 디스플레이에 **전화 통화** 아이콘과 전화 통화가 표시됩니다.
- 녹색 LED가 깜박입니다.
- 무전기 음소거가 해제되고 호출 수신 시 스피커를 통해 소리가 납니다.

1 PTT 버튼을 눌러 호출에 응답합니다.

2 상대방의 말을 들으려면 **PTT** 버튼을 놓습니다.

3  버튼을 눌러 통화를 종료합니다.



주의:

무전기가 그룹 호출로 전화 통화를 종료할 수 없습니다. 전화 사용자가 통화를 종료해야 합니다. 수신 사용자의 경우 통화 도중 응답만 허용됩니다.

디스플레이에 전화 통화 종료 중이 표시됩니다. 통화를 성공적으로 종료한 경우:

- 신호음이 울립니다.
- 디스플레이에 통화 종료가 표시됩니다.

통화 종료에 실패하면 무전기가 전화 통화 화면으로 돌아갑니다. **단계 3**을(를) 반복하여 호출을 종료합니다.

호출 선점

무전기는 호출 선점 기능을 사용하여 진행 중인 음성 전송을 중지하고 우선순위 전송을 시작할 수 있습니다.

시스템은 호출 선점 기능을 사용하여 트렁킹된 채널이 없는 인스턴스에서 진행 중인 통화를 중지하고 선점합니다.

비상 호출 또는 전체 호출과 같이 우선 순위가 높은 호출은 우선 순위가 높은 호출을 수용하기 위해 전송 중인 무전기를 선점합니다. 다른 무선 주파수(RF) 채널을 사용할 수 없는 경우 비상 호출은 전체 호출도 선점합니다.

음성 중단

사용자는 음성 중단으로 진행 중인 음성 전송을 종료할 수 있습니다.

무전기 중단이 음성 중단으로 구성되어 있고, 무전기 전송이 음성 호출을 중단할 수 있도록 구성된 경우 이 기능은 역방

향 채널 신호를 사용하여 진행 중인 무전기 음성 전송을 중지합니다. 그런 다음 무전기 중단이 중지된 통화에서 참가자에게 음성을 전송하도록 허용됩니다.

음성 중단 기능은 통화 중일 때 예정된 당사자에게 새 전송을 성공적으로 전달할 확률을 크게 증가시킵니다.

무전기에서 이 기능이 설정된 경우에만 사용자가 음성 중단에 액세스할 수 있습니다. 자세한 내용은 대리점이나 시스템 관리자에게 문의하십시오.

음성 중단 활성화

다음 절차에 따라 무전기에서 음성 중단을 시작합니다.

이 기능을 사용할 수 있도록 무전기를 프로그래밍해야 합니다. 자세한 내용은 대리점이나 시스템 관리자에게 문의하십시오.

- 1 통화하던 중에 전송을 중단하려면 **PTT** 버튼을 누릅니다.

중단된 무전기에서는 디스플레이에 호출 중단이 표시됩니다. 무전기에서 **PTT** 버튼을 놓을 때까지 해제음이 울립니다.

- 2 승인을 기다립니다.
성공 시:

- 선택음이 울립니다.

실패 시:

- 해제음이 울립니다.

3 다음 중 하나를 수행합니다.

- 통화 허용 신호음(활성화된 경우)이 끝날 때까지 기다렸다가 마이크에 대고 명확히 말합니다.
- **PTT** 사이드톤(활성화된 경우)이 끝날 때까지 기다렸다가 마이크에 대고 또렷하게 말합니다.

고급 기능

이 장에서는 무전기에서 사용할 수 있는 기능 작동에 대해 설명합니다.

대리점에서 또는 시스템 관리자가 특정 요구에 맞게 무전기를 사용자 정의했을 수 있습니다. 자세한 내용은 대리점이나 시스템 관리자에게 문의하십시오.

호출 대기열

호출 처리에 사용할 수 있는 리소스가 없는 경우 다음에 사용할 수 있는 리소스를 위해 시스템 대기열의 호출 대기열을 사용하여 호출 요청을 활성화할 수 있습니다.

PTT 버튼을 누르면 무전기가 통화 대기열 상태임을 나타내는 통화 대기열 신호음이 울리고 무전기 화면에 통화 대기열이 표시됩니다. 호출 대기열 신호음이 울린 후 **PTT** 버튼이 원래대로 돌아옵니다.

호출 설정에 성공했다면 다음이 발생합니다.

- 녹색 LED가 깜박입니다.
- 활성화된 경우 통화 허가 신호음이 울립니다.
- 디스플레이에 호출 유형 아이콘, ID 또는 별칭이 표시됩니다.
- 무전기 사용자는 최대 4초 동안 **PTT** 버튼을 눌러서 음성 전송을 시작할 수 있습니다.

호출 설정에 실패한 경우 다음이 발생합니다.

- 활성화된 경우 거부 신호음이 울립니다.
- 디스플레이에 실패 알림 화면이 잠깐 동안 표시됩니다.
- 호출이 중단되고 무전기가 호출 설정을 종료합니다.

우선 순위 통화

우선 순위 통화는 시스템이 진행 중인 비우선 순위 통화 중 하나를 선점하고 모든 채널이 통화 중일 때 요청된 우선 순위가 높은 통화를 시작하도록 합니다.

모든 채널이 우선 순위가 높은 통화로 점유되면 시스템은 어떠한 통화도 선점하지 않으며, 우선 순위가 높은 요청 통화를 통화 대기열에 배치합니다. 시스템이 우선 순위가 높은 요청 통화를 통화 대기열에 배치하지 못하면 실패를 선언합니다.

우선 순위 통화의 기본 설정은 사전 구성되어 있습니다. 프로그래밍 가능 버튼을 눌러 보통 및 높은 우선 순위 수준 사이를 전환합니다. 다음 기능을 사용하면 통화 우선 순위 수준이 미리 구성된 설정으로 자동으로 되돌아갑니다.

- 모든 음성 호출
- DMR III 문자 메시지/문자 메시지
- 작업 티켓
- 원격 모니터링



주의:

무전기가 프로그래밍된 방식에 대해서는 대리점이나 시스템 관리자에게 문의하십시오.

우선 순위 통화 유형은 다음과 같습니다.

높은 우선 순위

무전기에 다음 호출:이 표시됩니다. 높은 우선 순위.

높은 우선 순위 통화 아이콘이 무전기 디스플레이 상단에 나타납니다.

음성 안내에서 다음 호출이 울립니다. 높은 우선 순위.

보통 우선 순위

무전기에 다음 호출:이 표시됩니다. 보통 우선 순위.

높은 우선 순위 통화 아이콘이 사라집니다.

음성 안내에서 다음 호출이 울립니다. 보통 우선 순위.

통화 그룹 스캔

이 기능을 사용하면 무전기가 수신 그룹 목록으로 정의된 그룹의 호출을 모니터링하고 참여할 수 있습니다.

스캔이 활성화된 경우 상태 표시줄에 스캔 아이콘이 표시되고 LED가 녹색으로 깜박입니다. 수신 그룹 목록의 모든 구성원에 대해 무전기 음소거를 해제합니다.

스캔이 비활성화되면 무전기가 수신 그룹 목록의 어떤 구성원으로부터도 송신 내용을 수신하지 않습니다. 단 전체 호출과 선택된 통화 그룹은 예외입니다.







주의:







통화 그룹 스캔은 CPS를 통해 구성할 수 있습니다. 무전기가 프로그래밍된 방식에 대해서는 시스템 관리자에게 문의하십시오.

통화 그룹 스캔 켜기 또는 끄기

다음 절차에 따라 무전기에서 통화 그룹 스캔을 켜거나 끕니다.

- 1  버튼을 눌러 메뉴로 이동합니다.

- 2  또는  버튼을 눌러 스캔으로 이동합니다.
 버튼을 눌러 선택합니다.

- 3 다음 중 하나를 수행합니다.
 -  또는  버튼을 눌러 커서로 이동합니다.
 버튼을 눌러 선택합니다.
 -  또는  버튼을 눌러 끄기로 이동합니다.
 버튼을 눌러 선택합니다.

스캔이 활성화된 경우:

- 디스플레이에 스캔 커서 및 스캔 아이콘이 표시됩니다.
- 노란색 LED가 깜박입니다.
- 선택음이 울립니다.

스캔이 비활성화된 경우:

- 디스플레이에 스캔 끄기가 표시됩니다.
- 스캔 아이콘이 사라집니다.
- LED가 꺼집니다.

- 해제음이 울립니다.

수신 그룹 목록

수신 그룹 목록은 통화 그룹 스캔 목록에 구성원을 만들고 할당할 수 있는 기능입니다.

이 목록은 무전기가 프로그래밍되어 어떤 그룹을 스캔할지 결정할 때 생성됩니다. 무전기에서는 이 목록에서 최대 16명의 구성원을 지원할 수 있습니다.

스캔 목록을 편집할 수 있도록 무전기가 프로그래밍된 경우,

- 통화 그룹을 추가/제거합니다.
- 통화 그룹 우선순위를 추가, 제거, 편집합니다. **통화 그룹의 우선 순위 편집 페이지의 92**를 참조하십시오.
- 가입 통화 그룹을 추가, 제거 및/또는 편집합니다. **통화 그룹 가입 추가 페이지의 93** 및 **통화 그룹 가입 제거 페이지의 94**를 참조하십시오.
- 기존 스캔 목록을 새 스캔 목록으로 대체합니다.



중요:

목록에 구성원을 추가하려면 먼저 무전기에 통화 그룹을 구성해야 합니다.



주의:

수신 그룹 목록은 시스템 관리자가 프로그래밍합니다. 자세한 내용은 대리점이나 시스템 관리자에게 문의하십시오.

우선순위 모니터링

우선순위 모니터링 기능을 사용하면 무전기가 통화 그룹 호출을 받을 때 자동으로 우선순위가 높은 통화 그룹의 전송을 받을 수 있습니다.

무전기에서 우선순위가 낮은 통화 그룹을 미루고 우선순위가 높은 통화 그룹 호출을 받습니다.



주의:

이 기능은 통화 그룹 스캔 기능이 활성화된 경우에만 사용할 수 있습니다.

우선순위 모니터링 기능은 수신 그룹 목록에 있는 멤버에게만 적용됩니다. 우선 1(P1) 및 우선 2(P2)라는 2개의 우선순위 통화 그룹이 있습니다. P1이 P2보다 우선 순위가 높습니다. Capacity Max 시스템에서는 무전기가 다음 우선순위에 따라 전송 내용을 수신합니다.

- 1 P1 통화 그룹의 비상 호출
- 2 P2 통화 그룹의 비상 호출
- 3 수신 그룹 목록에 있는 우선순위가 없는 통화 그룹의 비상 호출

4 전체 호출

5 P1 통화 그룹 호출

6 P2 통화 그룹 호출

7 수신 그룹 목록에 있는 우선순위가 없는 통화 그룹

스캔 목록에서 통화 그룹 우선순위를 추가, 제거 및/또는 편집하는 방법에 대한 자세한 내용은 [통화 그룹의 우선 순위 편집 페이지의 92](#)을 참조하십시오.



주의:



이러한 기능은 시스템 관리자가 프로그래밍합니다. 자세한 내용은 대리점이나 시스템 관리자에게 문의하십시오.



통화 그룹의 우선 순위 편집



통화 그룹 스캔 메뉴에서 통화 그룹의 우선순위를 확인 또는 편집할 수 있습니다.



- 1 버튼을 눌러 메뉴로 이동합니다.

- 2 또는 버튼을 눌러 스캔으로 이동합니다.
 버튼을 눌러 선택합니다.



3  또는  버튼을 눌러 목록 보기/편집으로 이동합니다.  버튼을 눌러 선택합니다.

4  또는  버튼을 눌러 필요한 통화 그룹으로 이동합니다.  버튼을 눌러 선택합니다.
통화 그룹 옆의 **우선 1** 또는 **우선 2** 아이콘으로 현재의 우선순위가 표시됩니다.

5  또는  버튼을 눌러 우선 순위 편집으로 이동합니다.  버튼을 눌러 선택합니다.

6  또는  버튼을 눌러 원하는 우선 순위 레벨로 이동합니다.  버튼을 눌러 선택합니다.

다른 통화 그룹이 **우선 1** 또는 **우선 2**에 할당되면 현재 우선순위를 덮어쓰도록 선택할 수 있습니다. 디스플레이에 덮어쓰시겠습니까?라는 메시지가 표시되면

 또는  버튼을 눌러 다음 옵션을 선택합니다.

- 아니요를 선택하여 이전 단계로 돌아갑니다.

- 예를 선택하여 덮어씁니다.

이전 화면으로 돌아가기 전에 디스플레이에 선택 미니 알림이 표시됩니다. 통화 그룹 옆에 우선순위가 표시됩니다.

여러 개의 통화 그룹 가입

Capacity Max 시스템에서 무전기에 사이트당 최대 7개의 통화 그룹을 구성할 수 있습니다.

수신 그룹 목록에 있는 16개의 통화 그룹 중 최대 7개의 통화 그룹을 가입 통화 그룹으로 할당할 수 있습니다. 선택한 통화 그룹 및 우선순위 통화 그룹이 자동으로 가입됩니다.





주의:

이러한 기능은 시스템 관리자가 프로그래밍합니다. 자세한 내용은 대리점이나 시스템 관리자에게 문의하십시오.



통화 그룹 가입 추가

다음 절차에 따라 통화 그룹 가입을 추가하십시오.



- 1  버튼을 눌러 메뉴로 이동합니다.

2  또는  버튼을 눌러 스캔으로 이동합니다.



 버튼을 눌러 선택합니다.

3  또는  버튼을 눌러 목록 보기/편집으로

이동합니다.  버튼을 눌러 선택합니다.



4  또는  버튼을 눌러 원하는 통화 그룹 ID 또는 별칭으로 이동합니다.  버튼을 눌러 선택합니다.

가입 상태는 목록 보기/편집에 표시됩니다. 디스플레이에서 선택한 통화 그룹 ID 또는 별칭 옆에 이 표시됩니다.



5  또는  버튼을 눌러 가입 편집으로 이동합니다.

 버튼을 눌러 선택합니다.

6 다음 중 하나를 수행합니다.

-  또는  버튼을 눌러 켜기로 이동합니다.

 버튼을 눌러 선택합니다.

-  또는  버튼을 눌러 끄기로 이동합니다.

 버튼을 눌러 선택합니다.

켜기를 선택하면 통화 그룹 ID 또는 별칭 옆에 이 표시됩니다.

가입에 성공하면 디스플레이에서 선택한 통화 그룹 ID 또는 별칭 옆에 이 표시됩니다.

가입에 실패하면 통화 그룹 ID 또는 별칭 옆에 이 표시됩니다.







주의:



스캔 목록에서 가입을 위해 최대 7개의 통화 그룹이 선택되면 무전기에 목록 가득참이 표시됩니다. 가입을 위해 새 통화 그룹을 선택한 경우, 기존에 가입한 통화 그룹을 제거하여 새롭게 추가할 수 있습니다. 자세한 내용은 [통화 그룹 가입 제거 페이지의 94](#) 부분을 참조하십시오.





통화 그룹 가입 제거



가입 목록이 가득 차 있는 상태에서 가입을 위해 새 통화 그룹을 선택하려면 기존의 가입 통화 그룹을 제거하여 새롭게 추가하십시오. 다음 절차에 따라 통화 그룹 가입을 제거할 수 있습니다.





- 1  버튼을 눌러 메뉴로 이동합니다.

- 2  또는  버튼을 눌러 스캔으로 이동합니다.
 버튼을 눌러 선택합니다.

- 3  또는  버튼을 눌러 목록 보기/편집으로 이동합니다.  버튼을 눌러 선택합니다.

- 4  또는  버튼을 눌러 원하는 통화 그룹 ID 또는 별칭으로 이동합니다.  버튼을 눌러 선택합니다.
가입 상태는 목록 보기/편집에 표시됩니다. 디스플레이에서 선택한 통화 그룹 ID 또는 별칭 옆에 이 표시됩니다.

- 5  또는  버튼을 눌러 가입 편집으로 이동합니다.  버튼을 눌러 선택합니다.

- 6  또는  버튼을 눌러 *끄기*로 이동합니다.
 버튼을 눌러 선택합니다.
*끄기*를 선택하면 통화 그룹 ID 또는 별칭 옆에 이 사라집니다.

Talkback

토크백 기능을 사용하면 스캔 중 전송에 응답할 수 있습니다.

무전기가 선택한 그룹 스캔 목록에서 호출을 스캔하고 스캔한 호출 중에 **PTT** 버튼을 누른 경우 무전기의 작동은 무전기 프로그래밍 중에 토크백의 활성화 여부에 따라 달라집니다. 자세한 내용은 대리점이나 시스템 관리자에게 문의하십시오.

토크백 비활성화

무전기는 스캔한 호출을 그대로 두고 현재 선택한 채널 위치의 연락처에서 전송을 시도합니다. 현재 선택한 연락처에서 호출 정지 시간이 만료되면 무전기는 홈 채널로 돌아가고 스캔 정지 시간 타이머를 시작합니다. 무전기는 스캔 정지 시간 타이머가 만료되면 그룹 스캔을 다시 시작합니다.

토크백 활성화

스캔된 호출의 그룹 정지 시간 중에 **PTT** 버튼을 누르면 무전기가 스캔된 그룹으로의 전송을 시도합니다.



주의:

현재 선택한 존의 채널 위치에 할당되지 않은 그룹에 대한 호출을 스캔하지만 호출이 종료된 경우 적절한 존으로 전환한 다음 해당 그룹에 회신할 그룹 채널 위치를 선택합니다.

Bluetooth

이 기능을 사용하면 Bluetooth 연결을 통해 무전기를 Bluetooth 사용 장치(액세서리)와 함께 사용할 수 있습니다. 이 무전기는 Motorola Solutions 및 Commercially available Off-The-Shelf(COTS) Bluetooth 사용 장치를 모두 지원합니다.

Bluetooth는 시야 10m(32피트) 범위 내에서 작동합니다. 이 범위 내에 있어야 무전기와 Bluetooth 사용 장치 간에 장애 없이 통신이 이루어집니다. 높은 신뢰성을 위해 무전기와 액세서리를 분리하지 말 것을 권장합니다.

수신 주변 영역에서는 음성과 경보음 품질이 모두 "왜곡되거나" "끊겨서" 들리기 시작합니다. 이 문제를 해결하려면 무전기와 Bluetooth 사용 장치를 가까이(10m 내) 배치하여 깨끗한 오디오 수신을 재설정합니다. 무전기의 Bluetooth 기능은 10m 범위에서 최대 2.5mW(4dBm)로 작동합니다.

무전기는 다른 유형의 Bluetooth 사용 장치와의 Bluetooth 연결을 동시에 3개까지 지원할 수 있습니다. 헤드셋, 스캐너 및 POD(PTT-Only Device)를 예로 들 수 있습니다. 동일한 유형의 Bluetooth 장치와의 복수 연결은 지원되지 않습니다.

해당 Bluetooth 사용 장치의 전체 기능에 대한 자세한 내용은 Bluetooth 지원 장치의 사용 설명서를 참조하십시오.







주의:



CPS를 통해 비활성화된 경우 모든 Bluetooth 관련 기능이 비활성화되고 Bluetooth 장치 데이터베이스가 지워집니다.

블루투스 켜기 및 끄기

절차에 따라 Bluetooth를 켜고 끕니다.

-  버튼을 눌러 메뉴로 이동합니다.



-  또는  버튼을 눌러 Bluetooth로 이동합니다.  버튼을 눌러 선택합니다.



3  또는  을 눌러 내 상태로 이동합니다.



 버튼을 눌러 선택합니다.



디스플레이에 켜기와 끄기가 표시됩니다. 현재 상태는  로 표시됩니다.

4 다음 중 하나를 수행합니다.

-  또는  버튼을 눌러 켜기로 이동합니다.

 버튼을 눌러 선택합니다.  가 디스플레이의 켜기 옆에 표시됩니다.

-  또는  버튼을 눌러 끄기로 이동합니다.



 버튼을 눌러 선택합니다.  가 디스플레이의 끄기 옆에 표시됩니다.



블루투스 장치에 연결

절차에 따라 Bluetooth 장치를 연결합니다.



블루투스 사용 장치를 켜고 페어링 모드로 설정합니다.





1  버튼을 눌러 메뉴로 이동합니다.



2  또는  버튼을 눌러 Bluetooth로 이동합니다.  버튼을 눌러 선택합니다.

3  또는  버튼을 눌러 장치로 이동합니다.  버튼을 눌러 선택합니다.

4 다음 중 하나를 수행합니다.

-  또는  버튼을 눌러 원하는 장치로 이동합니다.  버튼을 눌러 선택합니다.

-  또는  을 눌러 장치 찾기로 이동한 후 사용 가능한 장치를 찾습니다.  또는  버튼을 눌러 원하는 장치로 이동합니다.  버튼을 눌러 선택합니다.

5  또는  을 눌러 연결로 이동합니다.  버튼을 눌러 선택합니다.

블루투스 사용 장치에서 페어링을 완료하려면 추가 단계를 수행해야 할 수 있습니다. Bluetooth 사용 장치의 사용자 설명서를 참조하십시오.

디스플레이에 <장치>에 연결 중이 표시됩니다.

승인을 기다립니다.

성공 시:

- 선택음이 울립니다.
- 디스플레이에 <장치>에 연결됨 및 **Bluetooth 연결** 아이콘이 표시됩니다.
- 디스플레이에서 연결된 장치 옆에 ✓가 표시됩니다.

실패 시:

- 해제음이 울립니다.
- 디스플레이에 연결 실패가 표시됩니다.



주의:

PIN 코드가 필요한 경우 **비밀번호를 사용하여 무전기에 액세스 페이지의 172** 부분을 참조하십시오.

검색 가능 모드에서 블루투스 장치에 연결

절차에 따라 검색 가능 모드에서 Bluetooth 장치를 연결합니다.

Bluetooth 사용 장치를 켜고 페어링 모드로 설정합니다.

1



버튼을 눌러 메뉴로 이동합니다.

2

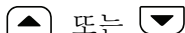

또는 을 눌러 Bluetooth로 이동합니다.



버튼을 눌러 선택합니다.

3

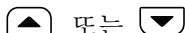

을 눌러 내 장치 찾기로 이동합니다.

 버튼을 눌러 선택합니다. 이제 프로그래밍하는 과정에서 다른 Bluetooth 사용 장치가 사용자의 무전기를 검색할 수 있습니다. 이를 검색 가능 모드로 하고 합니다.

승인을 기다립니다.

성공 시:

- 선택음이 울립니다.
- 디스플레이에 <장치>에 연결됨 및 **Bluetooth 연결** 아이콘이 표시됩니다.
- 디스플레이에서 연결된 장치 옆에 ✓가 표시됩니다.











실패 시:

- 해제음이 울립니다.

- 디스플레이에 연결 실패가 표시됩니다.

블루투스 장치 연결 해제

절차에 따라 Bluetooth 장치의 연결을 해제합니다.

- 1  버튼을 눌러 메뉴로 이동합니다.
- 2  또는  버튼을 눌러 Bluetooth로 이동합니다.  버튼을 눌러 선택합니다.
- 3  또는  버튼을 눌러 장치로 이동합니다.  버튼을 눌러 선택합니다.
- 4  또는  버튼을 눌러 원하는 장치로 이동합니다.  버튼을 눌러 선택합니다.
- 5  또는  버튼을 눌러 연결 해제로 이동합니다.  버튼을 눌러 선택합니다.
디스플레이에 <디바이스>에서 연결 끊는중이 표시 됩니다.



주의:

Bluetooth 사용 장치에서 연결을 끊으려면 추가 단계를 수행해야 할 수 있습니다. Bluetooth 사용 장치의 모든 사용자 설명서를 참조하십시오.

승인을 기다립니다.

- 신호음이 울립니다.
- 디스플레이에 <디바이스> 연결끊김이 표시되고 **Bluetooth 연결** 아이콘이 사라집니다.
- 연결된 장치 옆에 있는 ✓가 사라집니다.

무전기 내부 스피커와 블루투스 장치 간에 오디오 라우팅 전환

다음 절차에 따라 무전기 내부 스피커와 외부 Bluetooth 장치 간에 오디오 라우팅을 전환할 수 있습니다.

프로그래밍된 Bluetooth 오디오 스위치 버튼을 누릅니다.

디스플레이에 다음 결과 중 하나가 표시됩니다.

- 신호음이 울립니다. 디스플레이에 무전기로 오디오 내보내기가 표시됩니다.

- 신호음이 울립니다. 디스플레이에 Bluetooth로 오디오 내보내기가 표시됩니다.

장치 세부 항목 보기

다음 절차에 따라 무전기에서 장치 세부 정보를 확인합니다.

- 1  버튼을 눌러 메뉴로 이동합니다.
- 2  또는  버튼을 눌러 Bluetooth로 이동합니다.  버튼을 눌러 선택합니다.
- 3  또는  버튼을 눌러 장치로 이동합니다.  버튼을 눌러 선택합니다.
- 4  또는  버튼을 눌러 원하는 장치로 이동합니다.  버튼을 눌러 선택합니다.
- 5  또는  버튼을 눌러 세부 항목 보기로 이동합니다.  버튼을 눌러 선택합니다.

장치 이름 삭제

분리된 장치를 블루투스 사용 장치 목록에서 제거할 수 있습니다.

- 1  버튼을 눌러 메뉴로 이동합니다.
- 2  또는  버튼을 눌러 Bluetooth로 이동합니다.  버튼을 눌러 선택합니다.
- 3  또는  버튼을 눌러 장치로 이동합니다.  버튼을 눌러 선택합니다.
- 4  또는  버튼을 눌러 원하는 장치로 이동합니다.  버튼을 눌러 선택합니다.
- 5  또는  버튼을 눌러 삭제로 이동합니다.  버튼을 눌러 선택합니다. 디스플레이에 장치 삭제 완료가 표시됩니다.

Bluetooth 마이크 계인

이 기능을 사용하여 연결된 Bluetooth 사용 장치의 마이크 계인 값을 제어할 수 있습니다.

- 1  버튼을 눌러 메뉴로 이동합니다.

- 2  또는  버튼을 눌러 Bluetooth로 이동합니다.  버튼을 눌러 선택합니다.

- 3  또는  버튼을 눌러 Bluetooth 마이크 계인으로 이동합니다.  버튼을 눌러 선택합니다.

- 4  또는  버튼을 눌러 Bluetooth 마이크 계인 유형 및 현재 값으로 이동합니다.  버튼을 눌러 선택합니다. 여기에서 값을 편집할 수 있습니다.

- 5  또는  버튼을 눌러 값을 늘이거나 줄입니다.  버튼을 눌러 선택합니다.

실내 위치







주의:



실내 위치 기능은 최신 소프트웨어 및 하드웨어와 모델에만 적용됩니다. 자세한 내용은 대리점이나 시스템 관리자에게 문의하십시오.

실내 위치는 무전기 사용자의 위치를 추적하는 데 사용됩니다. 실내 위치가 활성화되면 무전기가 제한된 검색 가능 모드가 됩니다. 무전기를 찾아 해당 위치를 확인할 전용 비콘이 사용됩니다.

실내 위치 켜기 또는 끄기

다음 작업 중 하나를 수행하여 실내 위치를 켜거나 끌 수 있습니다.

- 메뉴를 통해 이 기능에 액세스합니다.
 - a.  버튼을 눌러 메뉴에 액세스합니다. 버튼을 누릅니다.
 - b.  또는  을 눌러 Bluetooth 및 선택하려면  버튼을 누릅니다.로 이동합니다.

c.  또는  을 눌러 실내 위치 및 선택하려면  버튼을 누릅니다.로 이동합니다.

d.  을 눌러 실내 위치를 켭니다.
디스플레이에 실내 위치 켜기가 표시됩니다. 선택음이 들립니다.
다음 시나리오 중 하나가 발생합니다.

- 성공할 경우, 홈 화면 디스플레이에 실내 위치 사용 가능 아이콘이 나타납니다.
- 실패하는 경우, 디스플레이에 켜기 실패가 표시됩니다. 해제음이 들립니다.

e.  을 눌러 실내 위치를 끕니다.
디스플레이에 실내 위치 끄기가 표시됩니다. 선택음이 들립니다.
다음 시나리오 중 하나가 발생합니다.

- 성공할 경우, 홈 화면 디스플레이에서 실내 위치 사용 가능 아이콘이 사라집니다.
- 실패하는 경우, 디스플레이에 끄기 실패가 표시됩니다. 해제음이 들립니다.

• 프로그래밍된 버튼을 사용하여 이 기능에 액세스합니다.

a. 프로그래밍된 **실내 위치** 버튼을 길게 눌러 실내 위치를 켭니다.

디스플레이에 실내 위치 켜기가 표시됩니다. 선택음이 들립니다.
다음 시나리오 중 하나가 발생합니다.

- 성공할 경우, 홈 화면 디스플레이에 실내 위치 사용 가능 아이콘이 나타납니다.
- 실패하는 경우, 디스플레이에 켜기 실패가 표시됩니다. 실패하는 경우, 해제음이 들립니다.

b. 프로그래밍된 **실내 위치** 버튼을 눌러 실내 위치를 끕니다.

디스플레이에 실내 위치 끄기가 표시됩니다. 선택음이 들립니다.
다음 시나리오 중 하나가 발생합니다.

- 성공할 경우, 홈 화면 디스플레이에서 실내 위치 사용 가능 아이콘이 사라집니다.
- 실패하는 경우, 디스플레이에 끄기 실패가 표시됩니다. 실패하는 경우, 해제음이 들립니다.

실내 위치 비콘 정보에 액세스

다음 절차에 따라 실내 위치 비콘 정보에 액세스합니다.

- 1  버튼을 눌러 메뉴에 액세스합니다.  를 누릅니다.

- 2  또는  을 눌러 Bluetooth 및 선택하려면  버튼을 누릅니다.  로 이동합니다.

- 3  또는  을 눌러 실내 위치 및 선택하려면  버튼을 누릅니다.  로 이동합니다.

- 4  또는  을 눌러 비콘 및 선택하려면  버튼을 누릅니다.  로 이동합니다.

디스플레이에 비콘 정보가 표시됩니다.

멀티 사이트 컨트롤

현재 무전기 채널이 **Capacity Max** 시스템으로 구성된 경우 이러한 기능을 사용할 수 있습니다.

수동 사이트 검색 시작

신호 강도가 약하여 신호가 더 좋은 사이트를 찾으려면 다음 절차에 따라 수동 사이트 검색을 시작합니다.

무전기가 새 사이트를 찾는 경우:

- 선택음이 울립니다.

무전기에서 새 사이트를 찾지 못한 경우:

- 해제음이 울립니다.

사이트 잠금 켜기/끄기

사이트 잠금을 켜면 무전기가 현재 사이트만 검색합니다. 사이트 잠금을 끄면 무전기가 현재 사이트에 추가로 다른 사이트를 검색합니다.

프로그래밍된 **사이트 잠금** 버튼을 누릅니다.

사이트 잠금 기능이 켜진 경우:

- 무전기가 현재 사이트로 잠기면 성공음이 울립니다.
- 디스플레이에 사이트 잠금 완료가 표시됩니다.

사이트 잠금 기능이 꺼진 경우:



- 무전기가 잠기지 않으면 해제음이 울립니다.



- 디스플레이에 사이트 해제 완료가 표시됩니다.



인접 사이트 목록에 액세스

사용자는 이 기능으로 현재 홈 사이트의 인접 사이트 목록을 확인할 수 있습니다. 다음 절차에 따라 인접 사이트 목록에 액세스합니다.

- 1  버튼을 눌러 메뉴로 이동합니다.

- 2  또는  버튼을 눌러 유틸리티로 이동합니다.  버튼을 눌러 선택합니다.

- 3  또는  을 눌러 무전기 정보로 이동합니다.  버튼을 눌러 선택합니다.

- 4  또는  을 눌러 인접 사이트로 이동합니다.  버튼을 눌러 선택합니다.

홈 채널 미리 알림

이 기능은 무전기가 일정 시간 동안 홈 채널에 설정되어 있지 않는 경우 미리 알림을 제공합니다.

이 기능이 활성화된 경우 무전기가 일정 시간 동안 홈 채널에 설정되지 않으면 다음 상황이 주기적으로 발생합니다.

- 홈 채널 미리 알림음과 안내음이 울립니다.
- 디스플레이의 첫 번째 줄에 비가 표시됩니다.
- 두 번째 줄에 홈 채널이 표시됩니다.

홈 채널 미리 알림 음소거

홈 채널 미리 알림이 울리면 미리 알림을 일시적으로 음소거할 수 있습니다.



무음 홈 채널 미리 알림 프로그래밍 가능 버튼을 누릅니다.



디스플레이의 첫 번째 줄에 HCR이 표시되고 두 번째 줄에 음소거됨이 표시됩니다.



새 홈 채널 설정



홈 채널 미리 알림이 발생하면 새 홈 채널을 설정할 수 있습니다.

- 다음 중 하나를 수행합니다.
 - 현재 채널을 새로운 홈 채널로 설정하려면 **홈 채널 재설정** 프로그래밍 가능 버튼 누릅니다. 다음 단계를 건너뛴니다.
디스플레이의 첫 번째 줄에 채널 별칭이 표시되고 두 번째 줄에 새 홈 채널이 표시됩니다.
 -  버튼을 눌러 메뉴로 이동합니다.

-  또는  버튼을 눌러 유틸리티로 이동합니다.  버튼을 눌러 선택합니다.

-  또는  버튼을 눌러 무전기 설정으로 이동합니다.  버튼을 눌러 선택합니다.

-  또는  버튼을 눌러 홈 채널로 이동합니다.  버튼을 눌러 선택합니다.

-  또는  버튼을 눌러 원하는 새 홈 채널 별칭으로 이동합니다.  버튼을 눌러 선택합니다.
디스플레이에서 선택한 홈 채널 별칭 옆에 ✓가 표시됩니다.

원격 모니터링

이 기능을 사용하면 가입자 별칭이나 ID를 사용하는 대상 무전기의 마이크를 켤 수 있습니다. 이 기능을 사용하면 대상 무전기와 관련된 모든 오디오 동작을 원격으로 모니터링할 수 있습니다.



이 기능을 사용할 수 있도록 무전기와 대상 무전기 모두를 프로그래밍해야 합니다.

시작하면 대상 무전기의 녹색 LED가 한 번 깜박입니다. 프로그래밍된 지속 시간 후 또는 대상 무전기에서 사용자 작업이 있는 경우 이 기능이 자동으로 중지됩니다.

원격 모니터 시작

다음 절차에 따라 무전기에서 원격 모니터를 시작합니다.

- 프로그래밍된 **원격 모니터** 버튼을 누릅니다.

- 2  또는  버튼을 눌러 원하는 별칭 또는 ID로 이동합니다.  버튼을 눌러 선택합니다.
- 디스플레이에 전환 미니 알림이 표시되어 요청이 진행 중임을 나타냅니다. 녹색 LED가 켜집니다.

3 승인을 기다립니다.

성공 시:

- 선택음이 울립니다.
- 디스플레이에 선택 미니 알림이 표시됩니다.
- 무전기에서 프로그래밍된 시간 동안 모니터링된 무전기로부터 음성을 수신하기 시작하고 디스플레이에 원격 모니터가 표시됩니다. 타이머가 만료되면 정보음이 울리고 LED가 꺼집니다.



실패 시:



- 해제음이 울립니다.
- 디스플레이에 해제 미니 알림이 표시됩니다.



연락처 목록을 사용하여 원격 모니터 시작

다음 절차에 따라 연락처 목록을 사용하여 무전기에서 원격 모니터를 시작합니다.

- 1  버튼을 눌러 메뉴로 이동합니다.

- 2  또는  버튼을 눌러 연락처로 이동합니다.
-  버튼을 눌러 선택합니다.

- 3  또는  버튼을 눌러 원하는 별칭 또는 ID로 이동합니다.  버튼을 눌러 선택합니다.

- 4  또는  버튼을 눌러 원격 모니터로 이동합니다.  버튼을 눌러 선택합니다.
- 디스플레이에 전환 미니 알림이 표시되어 요청이 진행 중임을 나타냅니다. 녹색 LED가 켜집니다.

5 승인을 기다립니다.

성공 시:

- 선택음이 울립니다.





- 디스플레이에 선택 미니 알람이 표시됩니다.
- 무전기에서 프로그래밍된 시간 동안 모니터링된 무전기로부터 음성을 수신하기 시작하고 디스플레이에 원격 모니터가 표시됩니다. 타이머가 만료 되면 경보음이 울리고 LED가 꺼집니다.



실패 시:



- 해제음이 울립니다.
- 디스플레이에 해제 미니 알람이 표시됩니다.

매뉴얼 다이얼을 사용하여 원격 모니터 시작



다음 절차에 따라 매뉴얼 다이얼을 사용하여 무전기에서 원격 모니터를 시작합니다.



- 1  버튼을 눌러 메뉴로 이동합니다.
- 2  또는  버튼을 눌러 연락처로 이동합니다.
 버튼을 눌러 선택합니다.

- 3  또는  버튼을 눌러 매뉴얼 다이얼로 이동합니다.  버튼을 눌러 선택합니다.

- 4  또는  버튼을 눌러 무전기 번호를 선택합니다.  버튼을 눌러 선택합니다.

- 5 다음 중 하나를 수행합니다.

- 가입자 별칭 또는 ID를 입력하고  버튼을 눌러 계속합니다.
- 이전에 연결했던 ID를 편집하고  버튼을 눌러 계속합니다.

- 6  또는  버튼을 눌러 원격 모니터로 이동합니다.  버튼을 눌러 선택합니다.

디스플레이에 전환 미니 알람이 표시되어 요청이 진행 중임을 나타냅니다. 녹색 LED가 켜집니다.

- 7 승인을 기다립니다.

성공 시:

- 선택음이 울립니다.
- 디스플레이에 선택 미니 알림이 표시됩니다.
- 무전기에서 프로그래밍된 시간 동안 모니터링된 무전기로부터 음성을 수신하기 시작하고 디스플레이에 원격 모니터가 표시됩니다. 타이머가 만료되면 정보음이 울리고 LED가 꺼집니다.

실패 시:

- 해제음이 울립니다.
- 디스플레이에 해제 미니 알림이 표시됩니다.

연락처 설정

연락처는 무전기에서 주소록 기능을 제공합니다. 각 항목은 호출을 시작하는 데 사용되는 별칭 또는 ID에 해당합니다. 항목은 알파벳 순서대로 정렬되어 있습니다.

각 항목은 컨텍스트에 따라 그룹 호출, 개별 호출, 전체 호출, PC 호출 또는 디스패치 호출이라는 서로 다른 호출 유형과 연결됩니다.

PC 호출 및 디스패치 호출은 데이터와 관련되어 있습니다. 이러한 호출은 응용 프로그램에서만 사용할 수 있습니다. 자세한 내용은 데이터 응용 프로그램 설명서를 참조하십시오.

또한 연락처 모음 메뉴를 사용하여 각 항목을 키패드 마이크의 프로그래밍 가능 숫자 키에 지정합니다. 숫자 키에 항목이 지정되면 무전기가 해당 항목에 대한 신속 다이얼을 수행할 수 있습니다.



주의:

항목에 지정된 각 숫자 키 앞에는 확인 표시가 있습니다. 비어 있음 앞에 확인 표시가 있으면 항목에 숫자 키를 지정하지 않은 것입니다.

연락처에 있는 각 항목에는 다음 정보가 표시됩니다.

- 호출 유형
- 호출 별칭
- 호출 ID







주의:



채널에서 프라이버시 기능이 활성화된 경우 해당 채널에서 프라이버시 활성화 그룹 호출, 개별 호출, 전체 호출 및 통화를 전송할 수 있습니다. 무전기와 동일한 프라이버시 키 또는 키 값과 키 ID를 가진 대상 무전기만 발신의 암호를 풀 수 있습니다.



프로그래밍 가능 숫자 키에 항목 할당



다음 절차에 따라 무전기에서 프로그래밍 가능한 숫자 키에 항목을 지정합니다.



- 1  버튼을 눌러 메뉴로 이동합니다.

- 2  또는  버튼을 눌러 연락처로 이동합니다.
 버튼을 눌러 선택합니다.

- 3  또는  버튼을 눌러 원하는 별칭 또는 ID로 이동합니다.  버튼을 눌러 선택합니다.



- 4  또는  버튼을 눌러 프로그램 키를 선택합니다.  버튼을 눌러 선택합니다.

- 5 다음 중 하나를 수행합니다.
 - 원하는 숫자 키가 항목에 지정되지 않는 경우
 또는  버튼을 눌러 원하는 숫자 키로 이동합니다.  버튼을 눌러 선택합니다.
 - 원하는 숫자 키가 항목에 지정되어 있는 경우 디스플레이에 이 키는 할당됨이 표시된 다음 첫 번째 텍스트 줄에 덮어쓸까요?가 표시됩니다. 다음 중 하나를 수행합니다.

 또는  버튼을 눌러 예를 선택합니다.

 버튼을 눌러 선택합니다.

무전기에서 선택음이 울리고 디스플레이에 연락처 저장 완료와 선택 미니 알림이 표시됩니다.

 또는  을 눌러 아니요를 선택하여 이전 단계로 돌아갑니다.

각 항목을 서로 다른 숫자 키에 연결할 수 있습니다. 항목에 할당된 각 숫자 키 앞에는 ✓ 표시가 있습니다. 비었음 앞에 ✓ 표시가 있으면 해당 숫자 키가 할당되지 않은 것입니다.

특정 모드에서 항목에 숫자 키를 지정할 경우 다른 모드에서 숫자 키를 길게 누르면 이 기능이 지원되지 않습니다.



화면이 자동으로 이전 메뉴로 돌아갑니다.



항목과 프로그래밍 가능 숫자 키의 관계 제거



다음 절차에 따라 무전기에서 항목과 프로그래밍 가능한 숫자 키의 관계를 제거합니다.



- 1 다음 중 하나를 수행합니다.



- 프로그래밍된 숫자 키를 길게 눌러 원하는 별칭이나 ID로 이동합니다. 단계 4로 진행합니다.
-  버튼을 눌러 메뉴로 이동합니다.

2  또는  버튼을 눌러 연락처로 이동합니다.
 버튼을 눌러 선택합니다.

3  또는  버튼을 눌러 원하는 별칭 또는 ID로 이동합니다.  버튼을 눌러 선택합니다.

4  또는  버튼을 눌러 프로그램 키를 선택합니다.  버튼을 눌러 선택합니다.

5  또는  버튼을 눌러 비어 있음을 선택합니다.  버튼을 눌러 선택합니다.
 첫 번째 텍스트 줄에 모든 키에서 삭제가 표시됩니다.

6  또는  버튼을 눌러 예를 선택합니다.  버튼을 눌러 선택합니다.



주의:

항목이 삭제되면 항목과 프로그래밍된 해당 숫자 키의 관계가 제거됩니다.



선택음이 울립니다. 디스플레이에 연락처 저장됨이 표시됩니다.



화면이 자동으로 이전 메뉴로 돌아갑니다.



새 연락처 추가

다음 절차에 따라 무전기에 새 연락처를 추가합니다.

1  버튼을 눌러 메뉴로 이동합니다.



2  또는  버튼을 눌러 연락처로 이동합니다.
 버튼을 눌러 선택합니다.

3  또는  버튼을 눌러 새 연락처로 이동합니다.  버튼을 눌러 선택합니다.

4  또는  을 눌러 연락처 유형 무전기 연락처 또는 전화 연락처를 선택합니다.  버튼을 눌러 선택합니다.

5 키패드로 연락처 번호를 입력하고  버튼을 눌러 계속합니다.

6 키패드로 연락처 이름을 입력하고  버튼을 눌러 계속합니다.

7  또는  버튼을 눌러 원하는 호출음 유형으로 이동합니다.  버튼을 눌러 선택합니다. 선택음이 울립니다. 디스플레이에 선택 미니 알림이 표시됩니다.



호출 표시 설정



이 기능을 사용하면 무전기 사용자가 호출 또는 문자 메시지 호출음을 구성할 수 있습니다.



개별 호출용 호출음 활성화 또는 비활성화



다음 절차에 따라 무전기에서 개별 호출용 호출음을 활성화 하거나 비활성화합니다.



1  버튼을 눌러 메뉴로 이동합니다.





2  또는  버튼을 눌러 유틸리티로 이동합니다.  버튼을 눌러 선택합니다.

3  또는  버튼을 눌러 무전기 설정으로 이동합니다.  버튼을 눌러 선택합니다.

4  또는  버튼을 눌러 톤/경보로 이동합니다.  버튼을 눌러 선택합니다.

5  또는  버튼을 눌러 호출음으로 이동합니다.  버튼을 눌러 선택합니다.



6  또는  을 눌러 개별 호출로 이동합니다.  버튼을 눌러 선택합니다.



7  또는  버튼을 눌러 원하는 신호음으로 이동합니다.  버튼을 눌러 선택합니다.
활성화되면  아이콘이 활성화 옆에 표시됩니다. 비활성화되면  아이콘이 활성화 옆에서 사라집니다.



문자 메시지용 호출음 활성화 또는 비활성화



다음 절차에 따라 무전기에서 문자 메시지용 호출음을 활성화하거나 비활성화합니다.





1  버튼을 눌러 메뉴로 이동합니다.

2  또는  버튼을 눌러 유틸리티로 이동합니다.  버튼을 눌러 선택합니다.

3  또는  버튼을 눌러 무전기 설정으로 이동합니다.  버튼을 눌러 선택합니다.

4  또는  버튼을 눌러 톤/경보로 이동합니다.  버튼을 눌러 선택합니다.





5  또는  버튼을 눌러 호출음으로 이동합니다.  버튼을 눌러 선택합니다.

6  또는  을 눌러 문자 메시지로 이동합니다.  버튼을 눌러 선택합니다.
디스플레이에  및 현재 신호음이 표시됩니다.

- 7 ▲ 또는 ▼ 버튼을 눌러 원하는 신호음으로 이동합니다.  버튼을 눌러 선택합니다. ✓ 디스플레이에 선택한 신호음 옆에 가 표시됩니다.

호출 경보용 호출음 활성화 또는 비활성화

다음 절차에 따라 무전기에서 호출 경보용 호출음을 켜거나 끕니다.

- 1  버튼을 눌러 메뉴로 이동합니다.
- 2 ▲ 또는 ▼ 버튼을 눌러 유틸리티로 이동합니다.  버튼을 눌러 선택합니다.
- 3 ▲ 또는 ▼ 버튼을 눌러 무전기 설정으로 이동합니다.  버튼을 눌러 선택합니다.
- 4 ▲ 또는 ▼ 버튼을 눌러 신호음/경보로 이동합니다.  버튼을 눌러 선택합니다.



- 5 ▲ 또는 ▼ 버튼을 눌러 호출음으로 이동합니다.  버튼을 눌러 선택합니다.



- 6 ▲ 또는 ▼ 버튼을 눌러 호출 경보로 이동합니다.  버튼을 눌러 선택합니다.



- 7 ▲ 또는 ▼ 버튼을 눌러 원하는 신호음으로 이동합니다.  버튼을 눌러 선택합니다. ✓ 디스플레이에 선택한 신호음 옆에 가 표시됩니다.



선택 호출용 호출음 활성화 또는 비활성화





다음 절차에 따라 무전기에서 선택 호출용 호출음을 활성화 하거나 비활성화합니다.





- 1  버튼을 눌러 메뉴로 이동합니다.
- 2 ▲ 또는 ▼ 버튼을 눌러 유틸리티로 이동합니다.  버튼을 눌러 선택합니다.

3  또는  버튼을 눌러 무전기 설정으로 이동합니다.  버튼을 눌러 선택합니다.

4  또는  버튼을 눌러 톤/경보로 이동합니다.  버튼을 눌러 선택합니다.

5  또는  버튼을 눌러 호출음으로 이동합니다.  버튼을 눌러 선택합니다.



6  또는  버튼을 눌러 선택 호출로 이동합니다.  버튼을 눌러 선택합니다. 디스플레이에  및 현재 신호음이 표시됩니다.



7  또는  버튼을 눌러 원하는 신호음으로 이동합니다.  버튼을 눌러 선택합니다.  디스플레이에 선택한 신호음 옆에  가 표시됩니다.



문자 텔레메트리 상태용 호출음 활성화 또는 비활성화



다음 절차에 따라 무전기에서 문자 텔레메트리 상태용 호출음을 활성화하거나 비활성화합니다.





1  버튼을 눌러 메뉴로 이동합니다.

2  또는  버튼을 눌러 유틸리티로 이동합니다.  버튼을 눌러 선택합니다.

3  또는  버튼을 눌러 무전기 설정으로 이동합니다.  버튼을 눌러 선택합니다.







4  또는  버튼을 눌러 신호음/경보로 이동합니다.  버튼을 눌러 선택합니다.



5  또는  버튼을 눌러 호출음으로 이동합니다.  버튼을 눌러 선택합니다.



- 6  또는  을 눌러 텔리메트리로 이동합니다.
 버튼을 눌러 선택합니다.
 현재 신호음은  로 표시됩니다.
-





벨 스타일 지정

특정 연락처의 개별 호출, 호출 정보 및 문자 메시지를 수신할 때 미리 정의된 11가지 경보음 중 하나가 울리도록 무전기를 프로그래밍할 수 있습니다. 목록을 탐색하면 무전기에서 각각의 벨 스타일이 울립니다. 다음 절차에 따라 무전기에서 벨 스타일을 지정합니다.

- 1  버튼을 눌러 메뉴로 이동합니다.
-
- 2  또는  버튼을 눌러 연락처로 이동합니다.
 버튼을 눌러 선택합니다.
 항목은 알파벳 순서대로 정렬되어 있습니다.
-
- 3  또는  버튼을 눌러 원하는 별칭 또는 ID로 이동합니다.  버튼을 눌러 선택합니다.
-

- 4  또는  을 눌러 보기/편집으로 이동합니다.
 버튼을 눌러 선택합니다.
-

- 5 디스플레이에 벨소리 메뉴가 나타날 때까지  를 누릅니다.
 는 현재 선택된 신호음을 나타냅니다.
-

- 6  또는  을 눌러 원하는 신호음으로 이동합니다.  버튼을 눌러 선택합니다.
 선택한 신호음 옆에  A가 표시됩니다.
-

알람음 볼륨 높이기

무전기 호출이 무응답 상태로 있는 경우 계속 경보로 알려도록 무전기를 프로그래밍할 수 있습니다. 알람음이 울릴수록 볼륨이 자동으로 증가되도록 하면 됩니다. 이 기능을 켜지는 경보음이라고 합니다.

호출 목록 기능

무전기는 최근의 모든 발신, 응답 및 부재 중 개별 호출에 대한 기록을 보관합니다. 호출 목록 기능을 사용하면 최근 호출을 보고 관리할 수 있습니다.



무전기의 시스템 구성에 따라 부재중 호출 경보를 호출 로그에 포함시킬 수 있습니다. 각 호출 목록에서 다음 작업을 수행할 수 있습니다.



- 별칭 또는 ID를 연락처에 저장
- 호출 삭제
- 전체 호출 삭제
- 세부 항목 보기

최근 호출 목록 보기

다음 절차에 따라 무전기에서 최근 호출 목록을 봅니다.

- 1  버튼을 눌러 메뉴로 이동합니다.

- 2  또는  버튼을 눌러 호출 목록으로 이동합니다.  버튼을 눌러 선택합니다.

- 3  또는  버튼을 눌러 원하는 목록으로 이동합니다. 부재 중, 응답 및 발신 목록 중 하나를 선택할 수 있습니다.

 버튼을 눌러 선택합니다.

디스플레이에 가장 최근의 항목이 표시됩니다.



- 4  또는  버튼을 눌러 목록을 봅니다.



PTT 버튼을 눌러 디스플레이에 현재 표시된 별칭 또는 ID로 호출을 시작할 수 있습니다.



호출 목록의 별칭 또는 ID 저장



다음 절차에 따라 호출 목록에서 무전기의 별칭 또는 ID를 저장합니다.

- 1  버튼을 눌러 메뉴로 이동합니다.

- 2  또는  버튼을 눌러 호출 목록으로 이동합니다.  버튼을 눌러 선택합니다.

- 3  또는  버튼을 눌러 원하는 목록으로 이동합니다.  버튼을 눌러 선택합니다.

- 4  또는  버튼을 눌러 원하는 별칭 또는 ID로 이동합니다.  버튼을 눌러 선택합니다.



- 5  또는  버튼을 눌러 저장으로 이동합니다.  버튼을 눌러 선택합니다.
디스플레이에 커서가 깜박입니다.



- 6 원하는 별칭의 나머지 문자를 입력합니다.  버튼을 눌러 선택합니다.
별칭 없이 ID만 저장할 수 있습니다.
디스플레이에 선택 미나 알림이 표시됩니다.



호출 목록에서 호출 삭제



다음 절차에 따라 호출 목록에서 무전기의 호출을 삭제합니다.

- 1  버튼을 눌러 메뉴로 이동합니다.





- 2  또는  버튼을 눌러 호출 목록으로 이동합니다.  버튼을 눌러 선택합니다.

- 3  또는  버튼을 눌러 원하는 목록으로 이동합니다.  버튼을 눌러 선택합니다.
목록이 비어 있는 경우:
 - 신호음이 울립니다.
 - 디스플레이에 목록 비어 있음이 표시됩니다.

- 4  또는  버튼을 눌러 원하는 별칭 또는 ID로 이동합니다.  버튼을 눌러 선택합니다.

- 5  또는  을 눌러 항목 삭제?로 이동합니다.  버튼을 눌러 선택합니다.



- 6 다음 중 하나를 수행합니다.



-  버튼을 눌러 예를 선택하고 항목을 삭제합니다.
디스플레이에 항목 삭제 완료가 표시됩니다.
 -  또는  버튼을 눌러 아니오로 이동합니다.  버튼을 눌러 선택합니다.
무전기가 이전 화면으로 돌아갑니다.
-



호출 목록에서 전체 호출 삭제



다음 절차에 따라 호출 목록에서 무전기의 전체 호출을 삭제합니다.

- 1  버튼을 눌러 메뉴로 이동합니다.





 - 2  또는  버튼을 눌러 호출 목록으로 이동합니다.  버튼을 눌러 선택합니다.

 - 3  또는  버튼을 눌러 원하는 목록으로 이동합니다.  버튼을 눌러 선택합니다.
-

- 4  또는  버튼을 눌러 원하는 별칭 또는 ID로 이동합니다.  버튼을 눌러 선택합니다.
-

- 5  또는  버튼을 눌러 전체 삭제로 이동합니다.  버튼을 눌러 선택합니다.
-

- 6 다음 중 하나를 수행합니다.

-  버튼을 눌러 예를 선택하고 모든 항목을 삭제합니다.
디스플레이에 선택 미시 알림이 표시됩니다.
 -  또는  버튼을 눌러 아니오로 이동합니다.  버튼을 눌러 선택합니다.
무전기가 이전 화면으로 돌아갑니다.
-

호출 목록에서 세부 항목 보기

다음 절차에 따라 호출 목록에서 무전기의 세부 항목을 봅니다.

- 1  버튼을 눌러 메뉴로 이동합니다.
-

2 ▲ 또는 ▼ 버튼을 눌러 호출 목록으로 이동합니다. OK 버튼을 눌러 선택합니다.

3 ▲ 또는 ▼ 버튼을 눌러 원하는 목록으로 이동합니다. OK 버튼을 눌러 선택합니다.

4 ▲ 또는 ▼ 버튼을 눌러 원하는 별칭 또는 ID로 이동합니다. OK 버튼을 눌러 선택합니다.

5 ▲ 또는 ▼ 버튼을 눌러 세부 항목 보기로 이동합니다. OK 버튼을 눌러 선택합니다. 디스플레이에 세부 항목이 표시됩니다.

호출 정보 작동

호출 정보 페이지 기능을 사용하면 가능할 경우 호출한 사용자에게 연락하도록 특정 무전기 사용자에게 경보를 보낼 수 있습니다.

이 기능은 가입자 별칭 또는 ID에만 적용할 수 있으며 연락처, 매뉴얼 다이얼 또는 프로그래밍된 **원터치 액세스** 버튼을 이용하여 메뉴를 통해 액세스할 수 있습니다.

Capacity Max에서 무전기 사용자나 디스패처는 호출 정보 기능을 사용하여 다른 무전기 사용자에게 가능할 때 개시 무전기 사용자에게 다시 호출을 요청하는 경보를 보낼 수 있습니다. 이 기능은 음성 통신에 포함되어 있지 않습니다.

대리점이나 시스템 관리자는 다음 두 가지 방법으로 호출 정보 작동을 구성할 수 있습니다.

- 무전기는 사용자가 **PTT** 버튼을 눌러 개별 호출로 호출 발신자에게 직접 응답하도록 구성되어 있습니다.
- 무전기는 사용자가 **PTT** 버튼을 누르고 기타 통화 그룹 통신을 계속하도록 구성되어 있습니다. 호출 정보 항목에서 **PTT** 버튼을 누르면 사용자가 통화 발신자에게 응답할 수 없습니다. 사용자는 호출 로그 메뉴에서 부재중 호출 로그 옵션을 탐색하고 거기에서 호출 정보에 응답해야 합니다.

사용자는 **OACSU(Off Air Call Set-Up)** 개별 호출로 즉시 응답할 수 있으며, **FOACSU(Full Off Air Call Set-Up)** 개별 호출을 사용하려면 호출에 대한 사용자 승인이 필요합니다. 그러므로 호출 정보 기능에는 **OACSU** 유형 호출이 권장됩니다. **개별 호출 페이지의 66**을 참조하십시오.

호출 정보 전송

다음 절차에 따라 무전기에서 호출 정보를 전송합니다.



- 1 프로그래밍된 **원터치 액세스** 버튼을 누릅니다.
디스플레이에 호출 정보와 가입자 별칭 또는 ID가 표시됩니다. 녹색 LED가 켜집니다.



- 2 승인을 기다립니다.
호출 정보 승인이 수신되면 디스플레이에 선택 미니 알림이 표시됩니다.
호출 정보 승인이 수신되지 않으면 디스플레이에 해제 미니 알림이 표시됩니다.



연락처 목록을 사용하여 호출 정보 전송

다음 절차에 따라 연락처 목록을 사용하여 무전기에서 호출 정보를 전송합니다.

- 1  버튼을 눌러 메뉴로 이동합니다.

- 2  또는  버튼을 눌러 연락처로 이동합니다.
 버튼을 눌러 선택합니다.

- 3  또는  버튼을 눌러 원하는 별칭 또는 ID로 이동합니다.  버튼을 눌러 선택합니다.

- 4  또는  버튼을 눌러 호출 정보로 이동합니다.  버튼을 눌러 선택합니다.
디스플레이에 호출 정보와 가입자 별칭 또는 ID가 표시됩니다. 녹색 LED가 켜집니다.

- 5 승인을 기다립니다.
 - 호출 정보 승인이 수신되면 디스플레이에 선택 미니 알림이 표시됩니다.
 - 호출 정보 승인이 수신되지 않으면 디스플레이에 해제 미니 알림이 표시됩니다.

호출 정보에 응답

다음 절차에 따라 무전기에서 호출 정보에 응답합니다.

호출 경보를 수신하는 경우:

- 반복음이 울립니다.
- 노란색 LED가 깜박입니다.
- 디스플레이에 발신 무전기의 별칭 또는 ID와 함께 호출 정보가 나열된 알림 목록이 표시됩니다.

대리점이나 시스템 관리자의 구성에 따라 다음 중 하나를 수행하여 호출 경보에 응답할 수 있습니다.

- **PTT** 버튼을 누르고 발신자에게 직접 개별 호출로 응답합니다.
- **PTT** 버튼을 눌러 정상적인 통화 그룹 통신을 계속합니다.
호출 정보가 호출 목록 메뉴에서 부재중 호출 옵션으로 이동합니다. 부재 중 호출 목록에서 발신자에게 응답할 수 있습니다.

자세한 내용은 [알림 목록 페이지의 175](#) 및 [호출 목록 기능 페이지의 116](#) 부분을 참조하십시오.

음소거 모드

음소거 모드는 사용자가 무전기의 모든 오디오 표시등의 음을 소거할 수 있는 옵션을 제공합니다.

음소거 모드 기능이 실행되면 비상 작동과 같은 우선순위가 높은 기능을 제외한 모든 오디오 표시등이 음소거됩니다.

음소거 모드가 종료되면 무전기가 진행 중인 신호음과 오디오 전송을 재개합니다.



주의:

이 기능은 유료입니다. 자세한 내용은 대리점이나 시스템 관리자에게 문의하십시오.

음소거 모드 켜기

다음 절차에 따라 음소거 모드를 켭니다.

프로그래밍된 **음소거 모드** 버튼을 사용하여 이 기능에 액세스합니다.

음소거 모드가 활성화되면 다음이 발생합니다.

- 선택음이 울립니다.
- 디스플레이에 음소거 모드 켜기가 표시됩니다.
- 빨간색 LED가 깜박이기 시작하며 음소거 모드가 종료될 때까지 깜박입니다.
- 디스플레이의 홈 화면에 **음소거 모드** 아이콘이 표시됩니다.
- 무전기가 음소거됩니다.



- 구성된 기간 동안 음소거 모드 타이머가 카운트를 세기 시작합니다.



음소거 모드 타이머 설정



음소거 모드 기능은 음소거 모드 타이머의 시간을 미리 구성하여 활성화할 수 있습니다. 이 타이머는 무전기 메뉴에서 구성 가능하며 0.5-6시간 범위 내에서 설정할 수 있습니다. 타이머가 만료되면 음소거 모드도 종료됩니다.



타이머의 남은 시간이 0이면 미리 프로그래밍된 **음소거 모드** 버튼을 누를 때까지 음소거 상태를 무한 시간 동안 유지합니다.

- 1  버튼을 눌러 메뉴로 이동합니다.

- 2  또는  버튼을 눌러 유틸리티로 이동합니다.  버튼을 눌러 선택합니다.

- 3  또는  버튼을 눌러 무전기 설정으로 이동합니다.  버튼을 눌러 선택합니다.

- 4  또는  버튼을 눌러 음소거 타이머로 이동합니다.  버튼을 눌러 선택합니다.

- 5  또는  버튼을 눌러 다음 숫자 값을 수정한 뒤  버튼을 누릅니다.

음소거 모드 종료

이 기능은 음소거 모드 타이머가 만료되면 자동으로 종료할 수 있습니다.

다음 방법 중 한 가지를 사용하여 음소거 모드를 수동으로 종료합니다.

- 프로그래밍된 **음소거 모드** 버튼을 누릅니다.
- 아무 항목에서 **PTT** 버튼을 누릅니다.

음소거 모드가 비활성화되면 다음이 발생합니다.

- 해제음이 울립니다.
- 디스플레이에 음소거 모드 끄기가 표시됩니다.
- 점멸하는 빨간색 LED가 꺼집니다.
- **음소거 모드** 아이콘이 홈 화면에서 사라집니다.

- 무전기의 음소거가 해제되고 스피커 상태가 복구됩니다.
- 타이머가 만료되지 않으면 음소거 모드 타이머가 중단됩니다.



주의:

또한 사용자가 음성을 전송하거나 프로그래밍되지 않은 채널로 전환하면 음소거 모드가 종료됩니다.

비상 작동

비상 알람은 중요 상황을 나타내는 데 사용됩니다. 현재 채널에서 동작이 없을 때라도 언제든지 비상 작업을 시작할 수 있습니다.

Capacity Max에서 수신 중인 무전기는 한 번에 단일 비상 알람만 지원할 수 있습니다. 시작된 경우, 두 번째 비상 알람은 첫 번째 알람을 재정의합니다.

비상 알람이 수신되면, 수신자는 알람을 삭제하고 알람 목록을 종료하거나 **PTT** 버튼을 누른 후 비긴급 음성을 전송하여 비상 알람에 응답하도록 선택할 수 있습니다.

대리점 또는 시스템 관리자에서 프로그래밍된 **비상** 버튼의 버튼 누름 지속 시간을 설정할 수 있습니다. 단, 다른 모든 버튼과 마찬가지로 길게 누르기는 제외입니다.

짧게 누르기

지속 시간 0.05초 ~ 0.75초.

길게 누르기

지속 시간 1.00초 ~ 3.75초.

비상 버튼은 비상 켜기/끄기 기능으로 지정됩니다. **비상** 버튼에 작동 지정은 대리점에 문의하십시오.



주의:

예를 들어 **비상** 버튼을 짧게 누르면 비상 모드가 켜지도록 지정된 경우 **비상** 버튼을 길게 누르면 비상 모드가 종료됩니다.

비상 버튼을 길게 누르면 비상 모드가 켜지도록 지정된 경우 **비상** 버튼을 짧게 누르면 비상 모드가 종료됩니다.

무전기는 다음과 같은 세 가지 비상 알람을 지원합니다.

- 비상 알람
- 비상 알람 및 호출
- 비상 알람 후 음성 알림

또한 알람마다 다음과 같은 유형이 있습니다.

일반

무전기가 경보 신호를 발신하며 상태 표시음 및/또는 표시등으로 이를 나타냅니다.

무음

무전기가 경보 신호를 발신하지만 상태 표시음 및/또는 표시등은 작동하지 않습니다. 프로그래밍된 **핫 마이크**

전송 기간이 종료되거나 **PTT** 버튼을 누를 때까지 무전기가 해당 스피커를 통해 소리 없이 호출을 수신합니다.

무음 및 음성

무전기가 상태 표시음이나 표시등 작동 없이 경보 신호를 발신하지만 들어오는 호출의 경우 무전기의 스피커를 통해 소리가 나도록 합니다.



주의:

위의 비상 알람 중 하나만 프로그래밍된 **비상** 버튼이나 **비상** 풋 스위치에 지정할 수 있습니다.

비상 알람 전송

이 기능을 사용하면 무전기 그룹에 경보 표시를 발생시키는 비상 알람(비음성 신호)을 전송할 수 있습니다. 다음 절차를 따라 무전기에서 비상 알람을 전송합니다.

무전기가 묵음으로 설정되면 비상 모드 중에 신호음이나 상태 표시 화면이 나타나지 않습니다.

1 프로그래밍된 **비상 켜기** 버튼을 누릅니다.

다음 결과 중 하나가 보입니다.

- 디스플레이에 전송 알람과 대상 별칭이 표시됩니다.
- 디스플레이에 송신 텔레그램과 대상 별칭이 표시됩니다.

녹색 LED가 켜집니다. **비상** 아이콘이 표시됩니다.



주의:

프로그래밍된 경우, 비상 검색 신호음이 울립니다. 이 신호음은 무전기에서 음성을 전송하거나 수신할 때에는 음소거되고, 무전기의 비상 모드가 종료되면 중지됩니다. 비상 검색 신호음은 대리점이나 시스템 관리자에 의해 프로그래밍될 수 있습니다.

2 승인을 기다립니다.

성공 시:

- 비상 신호음이 울립니다.
 - 녹색 LED가 깜박입니다.
 - 디스플레이에 알람 전송이 표시됩니다.
- 모든 재시도 횟수를 초과하여 실패한 경우:
- 신호음이 울립니다.
 - 디스플레이에 알람 실패가 표시됩니다.

비상 알람 모드가 종료되고 무전기가 홈 화면으로 돌아갑니다.



주의:

비상 알람으로만 구성된 경우, 비상 프로세스는 비상 알람 전달만으로 구성됩니다. 시스템에서 승인이 수신되거나 채널 액세스 시도 횟수가 초과된 경우 비상이 종료됩니다.

비상 알람으로만 작동하는 경우 비상 알람 전송과 연관된 음성 호출이 없습니다.

비상 알람 및 호출 전송

이 기능을 사용하면 호출을 통해 비상 알람을 무전기 또는 디스패처 그룹으로 전송할 수 있습니다. 그룹 내 인프라 중 하나가 승인하면 무전기 그룹 전체가 프로그래밍된 비상 채널상에서 통신할 수 있습니다.

알람 프로세스 후 비상 호출을 수행하려면 무전기가 비상 알람 및 호출용으로 구성되어야 합니다.

1 프로그래밍된 비상 켜기 버튼을 누릅니다.

디스플레이에 전송 알람과 대상 별칭이 표시됩니다. **비상** 아이콘이 표시됩니다. 녹색 LED가 켜집니다.



주의:

프로그래밍된 경우, 비상 검색 신호음이 울립니다. 이 신호음은 무전기에서 음성을 전송하거나 수신할 때에는 음소거되고, 무전기의 비상 모드가 종료되면 중지됩니다.

비상 알람 승인이 성공적으로 수신된 경우:

- 비상 신호음이 울립니다.
- 녹색 LED가 깜박입니다.
- 디스플레이에 알람 전송이 표시됩니다.
- 디스플레이에 비상과 대상 그룹 별칭이 표시되면 무전기가 비상 호출 모드로 전환됩니다.

비상 알람 승인이 성공적으로 수신되지 않은 경우:

- 재시도가 모두 사용되었습니다.
- 낮은 신호음이 울립니다.
- 디스플레이에 알람 실패가 표시됩니다.
- 무전기의 비상 알람 모드가 종료됩니다.

2 PTT 버튼을 눌러 음성 전송을 시작합니다.

녹색 LED가 켜집니다. 디스플레이에 **그룹 호출** 아이콘이 표시됩니다.

- 3 다음 중 하나를 수행합니다.
- 통화 허용 신호음(활성화된 경우)이 끝날 때까지 기다렸다가 마이크에 대고 명확히 말합니다.
 - **PTT** 사이드톤(활성화된 경우)이 끝날 때까지 기다렸다가 마이크에 대고 또렷하게 말합니다.

4 상대방의 말을 들으려면 **PTT** 버튼을 놓습니다.
디스플레이에 발신자 및 그룹 별칭이 표시됩니다.

5 채널 프리 표시 기능이 활성화된 경우 발신 무전기에서 **PTT** 버튼을 놓으면 채널이 사용 가능하여 응답할 수 있음을 나타내는 짧은 경보음이 울립니다. **PTT** 버튼을 눌러 호출에 응답합니다.

6 비상 **끄기** 버튼을 눌러 비상 모드를 종료합니다.
무전기가 홈 화면으로 돌아갑니다.



주의:

무전기가 프로그래밍된 방식에 따라 통화 허가음이 울리지 않을 수 있습니다. 비상 상황에 대해 무전기가 프로그래밍된 방식에 대한 자세한 내용은 무전기 대리점 또는 시스템 관리자에게 문의하십시오.

비상 호출 발신자는  버튼을 눌러 진행 중인 비상 호출을 종료할 수 있습니다. 무전기가 호출 유힬 상태로 돌아가지만 비상 호출 화면은 그대로 남아 있습니다.

비상 알람 후 음성 알림 전송

이 기능을 사용하면 지시 음성이 포함된 비상 알람을 무전기 그룹으로 전송할 수 있습니다. 무전기 마이크가 자동으로 활성화되어 **PTT** 버튼을 누르지 않고도 무전기 그룹과 통신할 수 있습니다. 이와 같이 활성화된 마이크 상태를 *핫 마이크*라고도 합니다.



주의:

이 무전기는 후면 액세스서리 커넥터에 연결된 비 **IMPRES** 마이크를 감지할 수 없습니다. 프로그래밍된 특정 커넥터에서 마이크가 감지되지 않으면 대체 커넥터를 확인합니다. 이 때 무전기는 감지된 마이크에 우선 순위를 부여합니다.

무전기의 비상 주기 모드가 활성화된 경우 **핫 마이크**와 수신 기간이 프로그래밍된 기간 동안 반복됩니다. 비상 주기 모드 동안 수신된 호출이 스피커를 통해 울립니다.

프로그래밍된 수신 주기 중에 **PTT** 버튼을 누르면 **PTT** 버튼에서 손을 떼라는 금지 신호음이 들립니다. 무전기에서 **PTT** 버튼 작동을 무시하고 비상 모드를 누른 채로 유지합니다.

핫 마이크 중에 **PTT** 버튼을 누르고 **핫 마이크** 기간이 만료될 후에도 계속 누르고 있으면 **PTT** 버튼을 놓을 때까지 무전기가 전송을 계속합니다.

비상 알람 요청에 실패하면 무전기가 요청 전송을 다시 시도하지 않고 **핫 마이크** 상태로 바로 전환됩니다.



주의:

액세서리에 따라 **핫 마이크**가 지원되지 않을 수도 있습니다. 자세한 내용은 대리점이나 시스템 관리자에게 문의하십시오.

다음 절차에 따라 무전기에서 지시 음성이 포함된 비상 알람을 전송합니다.

- 1 프로그래밍된 **비상 켜기** 버튼이나 **비상 쏫** 스위치를 누릅니다.

다음 결과 중 하나가 나타납니다.

- 디스플레이에 전송 알람과 대상 별칭이 표시됩니다.

- 디스플레이에 송신 텔레그램과 대상 별칭이 표시됩니다.

녹색 LED가 켜집니다. **비상** 아이콘이 표시됩니다.

- 2 디스플레이에 알람 전송이 표시되면 마이크에 대고 명확히 말합니다.

다음과 같은 경우 무전기에서 자동으로 전송을 중지합니다.

- 비상 주기 모드가 활성화된 경우 **핫 마이크**와 호출 수신 간 주기 기간이 만료될 때
- 비상 주기 모드가 비활성화된 경우 **핫 마이크** 기간이 만료될 때

- 3 **비상 끄기** 버튼을 눌러 비상 모드를 종료합니다.

무전기가 홈 화면으로 돌아갑니다.

비상 알람 수신

수신 중인 무전기는 한 번에 하나의 비상 알람만 지원할 수 있습니다. 시작된 경우, 두 번째 비상 알람은 첫 번째 알람을 재정의합니다. 다음 절차에 따라 무전기에서 비상 알람을 수신하고 확인합니다.

비상 알람 수신 시:

- 신호음이 울립니다.
- 빨간색 LED가 깜박입니다.
- 디스플레이에 비상 알람 목록, 비상 통화 그룹 ID 또는 별칭, 발신 무전기의 ID 또는 별칭이 표시됩니다.

1  을 눌러 알람을 봅니다.

2  버튼을 눌러 알람 목록에 있는 항목의 작업 옵션 및 세부 정보를 확인합니다.

3  버튼을 누르고 예를 선택하여 알람 목록을 종료합니다.

무전기는 상단에 **비상 아이콘**이 표시된 홈 화면으로 돌아가 해결되지 않은 비상 알람을 알려줍니다. 알람 목록의 항목이 삭제되면 **비상 아이콘**이 사라집니다.

4  버튼을 눌러 메뉴로 이동합니다.



5 알람 목록을 다시 보려면 알람 목록을 선택합니다.

- 6 사용자가 비상 모드를 종료할 때까지 신호음이 울리고 적색 LED가 깜박입니다. 그러나 신호음이 울리지 않게 할 수 있습니다. 다음 중 하나를 수행합니다.
- **PTT** 버튼을 눌러 비상 알람을 수신한 무전기 그룹을 호출합니다.
 - 프로그래밍 가능 버튼을 누릅니다.
-

비상 알람에 응답

비상 알람이 수신되면, 수신자는 알람을 삭제하고 알람 목록을 종료하거나 **PTT** 버튼을 누른 후 비긴급 음성을 전송하여 비상 알람에 응답하도록 선택할 수 있습니다. 다음 절차에 따라 무전기에서 비상 알람에 응답합니다.

- 1 비상 알람 표시가 활성화되어 있는 경우, 무전기가 비상 알람을 수신하면 비상 알람 목록이 나타납니다.

 또는  버튼을 눌러 원하는 별칭 또는 ID로 이동합니다.

- 2 채널 프리 표시 기능이 활성화된 경우 발신 무전기에서 **PTT** 버튼을 놓으면 채널이 사용 가능하여 응답할 수 있음을 나타내는 짧은 경보음이 울립니다. **PTT** 버

튼을 누르면 비상 알람 대상으로 지정된 동일한 그룹에 비상 시가 아닌 음성을 전송합니다.

녹색 LED가 켜집니다.

3 다음 중 하나를 수행합니다.

- 통화 허용 신호음(활성화된 경우)이 끝날 때까지 기다렸다가 마이크에 대고 명확히 말합니다.
- **PTT** 사이드톤(활성화된 경우)이 끝날 때까지 기다렸다가 마이크에 대고 또렷하게 말합니다.

4 상대방의 말을 들으려면 **PTT** 버튼을 놓습니다.

비상을 시작한 무전기가 응답하는 경우:

- 빨간색 LED가 깜박입니다.
- 디스플레이에 **비상 호출** 아이콘, 비상 통화 그룹 ID 또는 별칭, 발신 무전기의 ID 또는 별칭이 표시됩니다.



주의:

비상 호출 표시가 활성화되지 않은 경우, 디스플레이에 **그룹 호출** 아이콘, 비상 통화 그룹 ID 또는 별칭, 발신 무전기의 ID 또는 별칭이 표시됩니다.

호출 포함 비상 알람에 응답

다음 절차에 따라 무전기에서 호출을 통해 비상 알람에 응답합니다.

비상 호출 수신 시:

- 비상 호출 표시 및 비상 호출 디코딩 신호음이 활성화되면 비상 호출 신호음이 울립니다. 비상 호출 표시만 활성화된 경우 비상 호출 신호음이 울리지 않습니다.
- 디스플레이 오른쪽 상단에 **비상 호출** 아이콘이 표시됩니다.
- 텍스트 줄에 비상 통화 그룹 ID 및 별칭, 발신 무전기의 ID 또는 별칭이 표시됩니다.
- 무전기 음소거가 해제되고 호출 수신 시 스피커를 통해 소리가 납니다.

- 1 채널 프리 표시 기능이 활성화된 경우 발신 무전기에서 **PTT** 버튼을 놓으면 채널이 사용 가능하여 응답할 수 있음을 나타내는 짧은 경보음이 울립니다. **PTT** 버튼을 눌러 호출에 응답합니다.

녹색 LED가 켜집니다.

- 2 통화 허용 신호음(활성화된 경우)이 끝날 때까지 기다렸다가 마이크에 대고 명확히 말합니다.

3 상대방의 말을 들으려면 **PTT** 버튼을 놓습니다.

비상을 시작한 무전기가 응답하는 경우:

- 빨간색 **LED**가 깜박입니다.
- 디스플레이에 **비상 호출** 아이콘, 비상 통화 그룹 ID 또는 별칭, 발신 무전기의 ID 또는 별칭이 표시됩니다.



주의:

비상 호출 표시가 활성화되지 않은 경우, 디스플레이에 **그룹 호출** 아이콘, 비상 통화 그룹 ID 또는 별칭, 발신 무전기의 ID 또는 별칭이 표시됩니다.









주의:

모든 상태는 **0-99** 사이에 해당되는 디지털 값을 갖습니다. 각 상태에 별칭을 지정하여 간편하게 참조할 수 있습니다.

상태 메시지 전송

다음 절차에 따라 상태 메시지를 전송합니다.



- 1 다음 중 하나를 수행합니다.
 - 프로그래밍된 **원터치 액세스** 버튼을 누릅니다. 다음 단계를 건너뛴니다.
 -  버튼을 눌러 메뉴로 이동합니다.
- 2  또는  버튼을 눌러 상태로 이동합니다.
 버튼을 눌러 선택합니다.
- 3  또는  버튼을 눌러 빠른 상태로 이동합니다.
다.  버튼을 눌러 선택합니다.



상태 메시지

이 기능을 사용하면 사용자가 상태 메시지를 다른 무전기로 전송할 수 있습니다.

빠른 상태 목록은 **CPS-RM**을 통해 구성되며 최대 **99**개의 상태로 구성됩니다.

상태 메시지의 최대 길이는 **16**자입니다.

4  또는  버튼을 눌러 필요한 상태 메시지로 이동합니다.  버튼을 눌러 선택합니다.

5  또는  버튼을 눌러 원하는 가입자 별칭이나 ID, 또는 그룹 별칭이나 ID로 이동합니다.  버튼을 눌러 선택합니다.

성공 시:

- 선택음이 울립니다.
- LED가 꺼집니다.
- 빠른 상태 화면으로 돌아가기 전에 디스플레이에 선택 미니 알림이 잠깐 동안 표시됩니다.
- 디스플레이에서 상태 메시지 전송 옆에 ✓가 표시됩니다.



실패 시:



- 해제음이 울립니다.
- LED가 꺼집니다.
- 빠른 상태 화면으로 돌아가기 전에 디스플레이에 실패 알림이 잠시 표시됩니다.

프로그래밍 가능 버튼을 사용하여 상태 메시지 전송

절차에 따라 프로그래밍 가능 버튼을 사용하여 상태 메시지를 전송합니다.

1 프로그래밍된 상태 메시지 버튼을 누릅니다.

2  또는  버튼을 눌러 필요한 상태 메시지로 이동합니다.  버튼을 눌러 선택합니다. 연락처 목록이 표시됩니다.

3  또는  버튼을 눌러 원하는 가입자 별칭이나 ID, 또는 그룹 별칭이나 ID로 이동합니다.  버튼을 눌러 선택합니다.

성공 시:

- 선택음이 울립니다.
- LED가 꺼집니다.
- 빠른 상태 화면으로 돌아가기 전에 디스플레이에 선택 미니 알림이 잠깐 동안 표시됩니다.
- 디스플레이에서 상태 메시지 전송 옆에 ✓가 표시됩니다.



실패 시:



- 해제음이 울립니다.
- LED가 꺼집니다.
- 빠른 상태 화면으로 돌아가기 전에 디스플레이에 실패 알림이 잠시 표시됩니다.



연락처 목록을 사용하여 상태 메시지 전송



절차에 따라 연락처 목록을 사용하여 상태 메시지를 전송하십시오.

- 1  버튼을 눌러 메뉴로 이동합니다.

- 2  또는  버튼을 눌러 연락처로 이동합니다.
 버튼을 눌러 선택합니다.

- 3  또는  버튼을 눌러 원하는 가입자 별칭이나 ID, 또는 그룹 별칭이나 ID로 이동합니다.  버튼을 눌러 선택합니다.

- 4  또는  버튼을 눌러 상태 전송으로 이동합니다.  버튼을 눌러 선택합니다.

- 5  또는  버튼을 눌러 필요한 상태 메시지로 이동합니다.  버튼을 눌러 선택합니다.

성공 시:

- 선택음이 울립니다.
- LED가 꺼집니다.
- 빠른 상태 화면으로 돌아가기 전에 디스플레이에 선택 미니 알림이 잠깐 동안 표시됩니다.
- 디스플레이에서 상태 메시지 전송 옆에 가 표시됩니다.



실패 시:



- 해제음이 울립니다.
- LED가 꺼집니다.
- 빠른 상태 화면으로 돌아가기 전에 디스플레이에 실패 알림이 잠시 표시됩니다.



매뉴얼 다이얼을 사용하여 상태 메시지 전송

절차에 따라 매뉴얼 다이얼을 사용하여 상태 메시지를 전송합니다.



- 1  버튼을 눌러 메뉴로 이동합니다.



- 2  또는  버튼을 눌러 연락처로 이동합니다.
 버튼을 눌러 선택합니다.

- 3  또는  버튼을 눌러 매뉴얼 다이얼로 이동합니다.  버튼을 눌러 선택합니다.

- 4  또는  버튼을 눌러 무전기 번호를 선택합니다.  버튼을 눌러 선택합니다.

- 5 가입자 별칭이나 ID, 또는 그룹 별칭이나 ID를 입력하고  버튼을 눌러 계속합니다.

- 6  또는  버튼을 눌러 상태 전송으로 이동합니다.  버튼을 눌러 선택합니다.

- 7  또는  버튼을 눌러 필요한 상태 메시지로 이동합니다.  버튼을 눌러 선택합니다.

성공 시:

- 선택음이 울립니다.
- LED가 꺼집니다.
- 빠른 상태 화면으로 돌아가기 전에 디스플레이에 선택 미니 알림이 잠깐 동안 표시됩니다.
- 디스플레이에서 상태 메시지 전송 옆에 가 표시됩니다.



실패 시:



- 해제음이 울립니다.
- LED가 꺼집니다.
- 빠른 상태 화면으로 돌아가기 전에 디스플레이에 실패 알림이 잠시 표시됩니다.



상태 메시지 보기

다음 절차에 따라 상태 메시지를 봅니다.

- 1  버튼을 눌러 메뉴로 이동합니다.

- 2  또는  버튼을 눌러 상태로 이동합니다.
 버튼을 눌러 선택합니다.

- 3  또는  버튼을 눌러 수신문자함으로 이동합니다.  버튼을 눌러 선택합니다.



- 4  또는  버튼을 눌러 필요한 상태 메시지로 이동합니다.  버튼을 눌러 선택합니다.
상태 콘텐츠 메시지가 무전기 사용자에게 표시됩니다.



또한 알림 목록을 통해 수신된 상태 메시지를 볼 수 있습니다. 자세한 내용은 [알림 목록 페이지의 175](#) 부분을 참조하십시오.



상태 메시지에 응답

다음 절차에 따라 상태 메시지에 응답할 수 있습니다.



- 1  버튼을 눌러 메뉴로 이동합니다.



- 2  또는  버튼을 눌러 상태로 이동합니다.
 버튼을 눌러 선택합니다.

- 3  또는  버튼을 눌러 수신 문자함으로 이동합니다.  버튼을 눌러 선택합니다.

- 4  또는  버튼을 눌러 필요한 상태 메시지로 이동합니다.  버튼을 눌러 선택합니다.

- 5 상태 콘텐츠가 표시됩니다.  버튼을 눌러 선택합니다.

- 6  또는  버튼을 눌러 회신으로 이동합니다.
 버튼을 눌러 선택합니다.

- 7  또는  버튼을 눌러 필요한 상태 메시지로 이동합니다.  버튼을 눌러 선택합니다.

성공 시:

- 선택음이 울립니다.
- LED가 꺼집니다.
- 수신문자함 화면으로 돌아가기 전에 디스플레이에 선택 미니 알림이 표시됩니다.
- 디스플레이에서 상태 메시지 전송 옆에 ✓가 표시됩니다.



실패 시:



- 해제음이 울립니다.
- LED가 꺼집니다.
- 수신문자함 화면으로 돌아가기 전에 디스플레이에 실패 알림이 잠깐 동안 표시됩니다.



상태 메시지 삭제

다음 절차에 따라 무전기에서 상태 메시지를 삭제합니다.



- 1  버튼을 눌러 메뉴로 이동합니다.



- 2  또는  버튼을 눌러 상태로 이동합니다.  버튼을 눌러 선택합니다.

- 3  또는  버튼을 눌러 수신 문자함으로 이동합니다.  버튼을 눌러 선택합니다.

- 4  또는  버튼을 눌러 필요한 상태 메시지로 이동합니다.  버튼을 눌러 선택합니다.

- 5 상태 콘텐츠가 표시됩니다.  버튼을 눌러 선택합니다.

- 6  또는  버튼을 눌러 삭제로 이동합니다.  버튼을 눌러 선택합니다.



- 7  또는  버튼을 눌러 예로 이동합니다.  버튼을 눌러 선택합니다.



- 수신문자함 화면으로 돌아가기 전에 디스플레이에 선택 미니 알림이 표시됩니다.



모든 상태 메시지 삭제



다음 절차에 따라 무전기에서 모든 상태 메시지를 삭제합니다.

- 1  버튼을 눌러 메뉴로 이동합니다.

- 2  또는  버튼을 눌러 상태로 이동합니다.
 버튼을 눌러 선택합니다.

- 3  또는  버튼을 눌러 수신 문자함으로 이동합니다.  버튼을 눌러 선택합니다.

- 4  또는  버튼을 눌러 전체 삭제로 이동합니다.  버튼을 눌러 선택합니다.

- 5  또는  버튼을 눌러 예를 선택합니다.  버튼을 눌러 선택합니다.

- 디스플레이에 목록 비어 있음이 표시됩니다.

문자 메시지

이 무전기는 다른 무전기나 문자 메시지 응용 프로그램에서 문자 메시지와 같은 데이터를 수신할 수 있습니다.

DMR(Digital Mobile Radio) 단문 메시지 및 문자 메시지라는 두 가지 유형의 문자 메시지가 있습니다. **DMR** 단문 메시지의 최대 길이는 **23**자입니다. 문자 메시지의 최대 길이는 제목 줄을 포함하여 **280**자입니다. 제목 줄은 이메일 응용 프로그램에서 보낸 메시지를 받은 경우에만 나타납니다.



주의:

최대 문자 길이는 최신 소프트웨어 및 하드웨어 모델에만 해당합니다. 이전 소프트웨어 및 하드웨어가 있는 무전기 모델의 경우 문자 메시지의 최대 길이는 **140**자입니다. 자세한 내용은 대리점이나 시스템 관리자에게 문의하십시오.

문자 메시지



문자 메시지는 수신 문자함에 저장되며 최근에 수신된 순서대로 정렬됩니다.



무전기는 비활성 타이머가 만료되는 즉시 현재 화면을 종료합니다. 홈 화면으로 돌아가려면 언제든지  버튼을 길게 누릅니다.



문자 메시지 보기

다음 절차에 따라 무전기에서 문자 메시지를 봅니다.

- 1  버튼을 눌러 메뉴로 이동합니다.

- 2  또는  버튼을 눌러 메시지로 이동합니다.
 버튼을 눌러 선택합니다.



- 3  또는  버튼을 눌러 수신 문자함으로 이동합니다.  버튼을 눌러 선택합니다.
수신 문자함이 비어 있는 경우:
 - 디스플레이에 목록 비어 있음이 표시됩니다.
 - 키패드 신호음이 켜져 있는 경우 신호음이 울립니다.



- 4  또는  버튼을 눌러 원하는 메시지로 이동합니다.  버튼을 눌러 선택합니다.
이메일 응용 프로그램에서 메시지를 보낸 경우에는 제목 줄이 표시됩니다.



텔레메트리 상태 문제 메시지 보기

다음 절차에 따라 수신 문자함에서 텔레메트리 상태 문자 메시지를 봅니다.

- 1  버튼을 눌러 메뉴로 이동합니다.

- 2  또는  버튼을 눌러 메시지로 이동합니다.
 버튼을 눌러 선택합니다.

- 3  또는  버튼을 눌러 수신 문자함으로 이동합니다.  버튼을 눌러 선택합니다.

- 4  또는  버튼을 눌러 원하는 메시지로 이동합니다.  버튼을 눌러 선택합니다.
텔레메트리 상태 문자 메시지에는 회신할 수 없습니다.
디스플레이에 텔레메트리: <상태 문자 메시지>가 표시됩니다.

- 5 홈 화면으로 돌아가려면  버튼을 길게 누릅니다.

문자 메시지에 응답

다음 절차에 따라 무전기에서 문자 메시지에 응답합니다.

문자 메시지 수신 시:



- 디스플레이에 발신자의 별칭 또는 ID와 함께 알림 목록이 표시됩니다.
- 디스플레이에 **메시지** 아이콘이 표시됩니다.



주의:



PTT 버튼을 누르면 무전기에서 문자 메시지 경보 화면이 종료되고 메시지의 발신자에 대한 개별 또는 그룹 호출이 설정됩니다.



1 다음 중 하나를 수행합니다.

-  또는  버튼을 눌러 읽기로 이동합니다.



 버튼을 눌러 선택합니다.

디스플레이에 문자 메시지가 표시됩니다. 이메일 응용 프로그램에서 메시지를 보낸 경우에는 제목 줄이 표시됩니다.

-  또는  버튼을 눌러 나중에 읽기로 이동합니다.  버튼을 눌러 선택합니다. 무전기가 문자 메시지 수신 이전 화면으로 돌아갑니다.

-  또는  버튼을 눌러 삭제로 이동합니다.  버튼을 눌러 선택합니다.

2 다음 중 하나를 수행합니다.



- 수신함으로 돌아가려면  을 누릅니다.
- 문자 메시지를 회신, 전달 또는 삭제하려면  버튼을 누 번 누릅니다.



단축 문자를 사용하여 문자 메시지에 회신



다음 절차에 따라 무전기에서 단축 문자를 사용하여 문자 메시지에 회신합니다.

1 다음 중 하나를 수행합니다.



- 프로그래밍된 **문자 메시지** 버튼을 누릅니다. 3단계로 이동합니다.
-  버튼을 눌러 메뉴로 이동합니다.



- 2**
-  또는  버튼을 눌러 메시지로 이동합니다.  버튼을 눌러 선택합니다.



3  또는  버튼을 눌러 수신 문자함으로 이동합니다.  버튼을 눌러 선택합니다.

4  또는  버튼을 눌러 원하는 메시지로 이동합니다.  버튼을 눌러 선택합니다.
이메일 응용 프로그램에서 메시지를 보낸 경우에는 제목 줄이 표시됩니다.

5  버튼을 눌러 하위 메뉴로 이동합니다.

6  또는  버튼을 눌러 회신으로 이동합니다.
 버튼을 눌러 선택합니다.

7  또는  버튼을 눌러 단축 회신으로 이동합니다.  버튼을 눌러 선택합니다.

8  또는  버튼을 눌러 원하는 메시지로 이동합니다.  버튼을 눌러 선택합니다.

디스플레이에 전환 미니 알림이 표시되어 메시지가 전송 중임을 나타냅니다.

9 승인을 기다립니다.

성공 시:

- 신호음이 울립니다.
- 디스플레이에 선택 미니 알림이 표시됩니다.

실패 시:

- 신호음이 울립니다.
 - 디스플레이에 해제 미니 알림이 표시됩니다.
 - 무전기가 재전송 옵션 화면으로 돌아갑니다.
-

문자 메시지 재전송

다음 절차에 따라 무전기에서 문자 메시지를 재전송합니다.

재전송 옵션 화면에 있는 경우:

 버튼을 눌러 동일한 메시지를 동일한 가입자 또는 그룹 별칭이나 ID로 재전송합니다.

성공 시:

- 선택음이 울립니다.
- 디스플레이에 선택 미니 알림이 표시됩니다.



실패 시:



- 해제음이 울립니다.
- 디스플레이에 해제 미니 알림이 표시됩니다.
- 무전기가 재전송 옵션 화면으로 돌아갑니다.

문자 메시지 전달

다음 절차에 따라 무전기에서 문자 메시지를 전달합니다.

재전송 옵션 화면에 있는 경우:

- 1  또는  버튼을 눌러 전달로 이동하고  버튼을 눌러 다른 가입자나 그룹 별칭 또는 ID로 동일한 메시지를 전송합니다.

- 2  또는  버튼을 눌러 원하는 별칭 또는 ID로 이동합니다.  버튼을 눌러 선택합니다.
디스플레이에 전환 미니 알림이 표시되어 메시지가 전송 중임을 나타냅니다.

- 3 승인을 기다립니다.

성공 시:

- 신호음이 울립니다.
- 디스플레이에 선택 미니 알림이 표시됩니다.

실패 시:

- 신호음이 울립니다.
- 디스플레이에 해제 미니 알림이 표시됩니다.











주의:

또한 대상 무전기 주소를 수동으로 선택할 수도 있습니다(매뉴얼 다이얼을 사용하여 문자 메시지 전달 페이지의 409 참조).

매뉴얼 다이얼을 사용하여 문자 메시지 전달

다음 절차에 따라 무전기의 매뉴얼 다이얼을 사용하여 문자 메시지를 전달합니다.

- 1  또는  버튼을 눌러 전달로 이동합니다.
 버튼을 눌러 선택합니다.
- 2  버튼을 눌러 다른 가입자나 그룹 별칭 또는 ID로 동일한 메시지를 전송합니다.
- 3  또는  버튼을 눌러 매뉴얼 다이얼로 이동합니다.  버튼을 눌러 선택합니다.
디스플레이에 무전기 번호:가 표시됩니다.
- 4 가입자 ID를 입력하고  버튼을 눌러 계속합니다.
디스플레이에 전환 미니 알림이 표시되어 메시지가 전송 중임을 나타냅니다.
- 5 승인을 기다립니다.
성공 시:

- 신호음이 울립니다.
 - 디스플레이에 선택 미니 알림이 표시됩니다.
- 실패 시:
- 신호음이 울립니다.
 - 디스플레이에 해제 미니 알림이 표시됩니다.





문자 메시지 편집



메시지를 편집하려면 편집을 선택합니다.



주의:









이메일 응용 프로그램에서 수신한 메시지의 제목 줄(있는 경우)은 편집할 수 없습니다.

- 1  또는  버튼을 눌러 편집합니다.  버튼을 눌러 선택합니다.
디스플레이에 커서가 깜박입니다.
- 2 키패드를 사용하여 메시지를 편집합니다.
 - 왼쪽으로 한 칸 이동하려면  버튼을 누릅니다.

- 오른쪽으로 한 칸 이동하려면 ▶ 또는  버튼을 누릅니다.
- 필요 없는 문자를 삭제하려면  버튼을 누릅니다.
- 문자 입력 방법을 변경하려면  버튼을 길게 누릅니다.

3 메시지를 작성했으면  버튼을 누릅니다.

4 다음 중 하나를 수행합니다.



-  또는  을 눌러 전송으로 이동하고  을 눌러 메시지를 전송합니다.
-  또는  을 눌러 저장으로 이동하고  을 눌러 임시 보관함 폴더에 메시지를 저장합니다.
-  을 눌러 메시지를 편집합니다.
-  을 눌러 메시지를 삭제하거나 임시 보관함 폴더로 저장합니다.



문자 메시지 작성

다음 절차에 따라 무전기에서 문자 메시지를 작성합니다.

1 다음 중 하나를 수행합니다.

- 프로그래밍된 **문자 메시지** 버튼을 누릅니다. 단계 3로 진행합니다.
-  버튼을 눌러 메뉴로 이동합니다.

2  또는  버튼을 눌러 메시지로 이동합니다.  버튼을 눌러 선택합니다.

3  또는  버튼을 눌러 작성으로 이동합니다.  버튼을 눌러 선택합니다. 깜박이는 커서가 나타납니다.

4 키패드를 사용하여 메시지를 입력합니다.





왼쪽으로 한 칸 이동하려면 ◀ 버튼을 누릅니다.

오른쪽으로 한 칸 이동하려면 ▶ 또는  버튼을 누릅니다.

필요 없는 문자를 삭제하려면  버튼을 누릅니다.

문자 입력 방법을 변경하려면  버튼을 길게 누릅니다.

5 메시지를 작성했으면  버튼을 누릅니다.
다음 중 하나를 수행합니다.







-  버튼을 눌러 메시지를 보냅니다.
-  버튼을 누릅니다.  or  버튼을 눌러 메시지 편집, 삭제 또는 저장 중에서 선택하십시오.  버튼을 눌러 선택합니다.

문자 메시지 전송

다음 절차에 따라 무전기로 문자 메시지를 전송합니다.

새로 작성된 문자 메시지 또는 저장된 문자 메시지가 있다고 가정합니다.

메시지 수신자를 선택합니다. 다음 중 하나를 수행합니다.

-  또는  버튼을 눌러 원하는 별칭 또는 ID로 이동합니다.  버튼을 눌러 선택합니다.
-  또는  버튼을 눌러 매뉴얼 다이얼로 이동합니다.  버튼을 눌러 선택합니다. 가입자 ID를 입력합니다. 디스플레이의 첫 번째 줄에 무전기 번호:가 표시되고, 디스플레이의 두 번째 줄에 커서가 깜박입니다. 가입자 별칭이나 ID를 입력합니다.  를 누릅니다.

디스플레이에 전환 미니 알람이 표시되어 메시지가 전송 중임을 나타냅니다.

성공 시:

- 신호음이 울립니다.
- 디스플레이에 선택 미니 알람이 표시됩니다.

실패 시:

- 낮은 신호음이 울립니다.
- 디스플레이에 해제 미니 알람이 표시됩니다.
- 메시지가 보낸 문자함 폴더로 이동합니다.
- 메시지에 전송 실패 아이콘이 표시됩니다.

**주의:**

새로 작성한 문자 메시지의 경우 무전기가 재 전송 옵션 화면으로 돌아갑니다.

수신 문자함의 문자 메시지 삭제

다음 절차에 따라 무전기에서 수신 문자함의 문자 메시지를 삭제합니다.

1 다음 중 하나를 수행합니다.

- 프로그래밍된 **문자 메시지** 버튼을 누릅니다. **단계 3**로 진행합니다.
-  버튼을 눌러 메뉴로 이동합니다.

2 또는 버튼을 눌러 메시지로 이동합니다.

 버튼을 눌러 선택합니다.

3 또는 버튼을 눌러 수신 문자함으로 이동합니다. 버튼을 눌러 선택합니다.

수신 문자함이 비어 있는 경우:

- 디스플레이에 목록 비어 있음이 표시됩니다.

- 신호음이 울립니다.

4 또는 버튼을 눌러 원하는 메시지로 이동합니다. 버튼을 눌러 선택합니다.

이메일 응용 프로그램에서 메시지를 보낸 경우에는 제목 줄이 표시됩니다.

5 버튼을 눌러 하위 메뉴로 이동합니다.

6 또는 버튼을 눌러 삭제로 이동합니다.

 버튼을 눌러 선택합니다.



7 또는 버튼을 눌러 예를 선택합니다. 버튼을 눌러 선택합니다.



디스플레이에 선택 미완료 알림이 표시됩니다. 화면이 수신 문자함으로 돌아갑니다.



수신 문자함의 모든 문자 메시지 삭제



다음 절차에 따라 무전기에서 수신 문자함의 모든 문자 메시지를 삭제합니다.

- 1 다음 중 하나를 수행합니다.
- 프로그래밍된 **문자 메시지** 버튼을 누릅니다. 단계 3로 진행합니다.
 -  버튼을 눌러 메뉴로 이동합니다.

- 2  또는  버튼을 눌러 메시지로 이동합니다.  버튼을 눌러 선택합니다.

- 3  또는  버튼을 눌러 수신 문자함으로 이동합니다.  버튼을 눌러 선택합니다.
- 수신 문자함이 비어 있는 경우:
- 디스플레이에 목록 비어 있음이 표시됩니다.
 - 신호음이 울립니다.

- 4  또는  버튼을 눌러 전체 삭제로 이동합니다.  버튼을 눌러 선택합니다.

- 5  또는  버튼을 눌러 예를 선택합니다.  버튼을 눌러 선택합니다.
- 디스플레이에 선택 미니 알림이 표시됩니다.

전송한 문자 메시지

다른 무전기로 전송된 메시지는 보낸 문자함 폴더에 저장됩니다. 최근에 전송한 문자 메시지는 항상 보낸 문자함 폴더 맨 위에 추가됩니다. 전송한 문자 메시지를 재전송, 전달, 편집 또는 삭제할 수 있습니다.

보낸 문자함 폴더에는 최근에 전송한 메시지를 최대 30통 저장할 수 있습니다. 폴더가 다 차면 다음에 전송한 문자 메시지가 폴더에서 가장 오래된 문자 메시지를 자동으로 대체합니다.

메시지를 전송하는 중에 메시지 전송 화면을 종료하면 디스플레이에 표시가 나타나거나 경보음이 울리지 않고 무전기는 보낸 문자함 폴더의 메시지 상태를 업데이트합니다.

보낸 문자함 폴더의 메시지 상태를 업데이트하기 전에 무전기 모드가 변경되거나 전원이 꺼지면 무전기에서 진행 중인 메시지를 완료할 수 없으며 메시지에 **전송 실패** 아이콘이 자동으로 표시됩니다.

무전기는 한 번에 최대 5개의 진행 중 메시지를 지원합니다. 이 작업을 진행하는 안에는 무전기에서 새 메시지를 전송할

수 없으며 해당 새 메시지에 **전송 실패** 아이콘이 자동으로 표시됩니다.

언제든지  를 길게 누르면 무전기가 홈 화면으로 돌아갑니다.







주의:



채널 유형(예: 컨벤셔널 디지털, **Capacity Plus** 채널)이 일치하지 않으면 전송 메시지를 편집, 전달 또는 삭제만 할 수 있습니다.

전송한 문자 메시지 보기

다음 절차에 따라 무전기에서 전송한 문자 메시지를 봅니다.



- 1 다음 중 하나를 수행합니다.
 - 프로그래밍된 **문자 메시지** 버튼을 누릅니다. **단계 3**로 진행합니다.
 -  버튼을 눌러 메뉴로 이동합니다.

- 2  또는  버튼을 눌러 메시지로 이동합니다.
 버튼을 눌러 선택합니다.

- 3  또는  버튼을 눌러 보낸 문자함으로 이동합니다.  버튼을 눌러 선택합니다.

보낸 문자함 폴더가 비어 있는 경우:

- 디스플레이에 목록 비어 있음이 표시됩니다.
- 키패드 신호음이 켜져 있는 경우 낮은 신호음이 울립니다.

- 4  또는  버튼을 눌러 원하는 메시지로 이동합니다.  버튼을 눌러 선택합니다.

화면 맨 위의 오른쪽 모서리에 있는 아이콘은 메시지의 상태를 나타냅니다. **보낸 문자함 아이콘**을 참조하십시오.





전송한 문자 메시지 전송

다음 절차에 따라 무전기에서 전송한 문자 메시지를 전송합니다.

전송한 메시지를 볼 때:

- 1  를 누릅니다.

2 전송한 문자 메시지를 재전송하거나 전달할 수 있습니다. 다음 중 하나를 수행합니다.

-  을 눌러 재전송으로 이동합니다.  버튼을 눌러 선택합니다.
-  을 눌러 전달로 이동합니다.  버튼을 눌러 선택합니다.

디스플레이에 전환 미니 알림이 표시되어 메시지가 전송 중임을 나타냅니다.

3 승인을 기다립니다.

성공 시:

- 신호음이 울립니다.
- 디스플레이에 선택 미니 알림이 표시됩니다.

실패 시:



- 신호음이 울립니다.
- 디스플레이에 해제 미니 알림이 표시됩니다.
- 무전기가 재전송 옵션 화면으로 이동합니다. 자세한 내용은 [문자 메시지 재전송 페이지의 139](#) 부분을 참조하십시오.

보낸 문자함 폴더에서 전송한 문자 메시지 삭제

다음 절차에 따라 무전기의 보낸 문자함 폴더에서 보낸 문자 메시지를 삭제합니다.

전송한 메시지를 볼 때:

1  를 누릅니다.

2  또는  버튼을 눌러 삭제로 이동합니다.



 버튼을 눌러 선택합니다.

보낸 문자함 폴더에서 전송한 모든 문자 메시지 삭제



다음 절차에 따라 무전기의 보낸 문자함 폴더에서 보낸 모든 문자 메시지를 삭제합니다.

1 다음 중 하나를 수행합니다.

- 프로그래밍된 **문자 메시지** 버튼을 누릅니다. [단계 3](#)로 진행합니다.
-  버튼을 눌러 메뉴로 이동합니다.



2  또는  버튼을 눌러 메시지로 이동합니다.

 버튼을 눌러 선택합니다.







3  또는  버튼을 눌러 보낸 문자함으로 이동합니다.  버튼을 눌러 선택합니다.

보낸 문자함 폴더가 비어 있는 경우:

- 디스플레이에 목록 비어 있음이 표시됩니다.
- 신호음이 울립니다.

4  또는  버튼을 눌러 전체 삭제로 이동합니다.  버튼을 눌러 선택합니다.

5 다음 중 하나를 수행합니다.

-  또는  버튼을 눌러 예를 선택합니다.
 버튼을 눌러 선택합니다.
디스플레이에 선택 미니 알림이 표시됩니다.
-  또는  버튼을 눌러 아니오로 이동합니다.
다.  버튼을 눌러 선택합니다.

무전기가 이전 화면으로 돌아갑니다.

저장된 문자 메시지

문자 메시지를 저장하고 나중에 전송할 수 있습니다.

문자 메시지를 작성하거나 편집하는 동안 **PTT** 버튼을 누르거나 모드를 변경하여 무전기에서 문자 메시지 작성/편집 화면이 종료되는 경우, 현재 문자 메시지는 자동으로 임시보관함 폴더에 저장됩니다.

최근에 전송한 문자 메시지가 항상 임시보관함 목록 맨 위에 추가됩니다.



초안 폴더에는 최근에 저장한 메시지가 최대 10개까지 저장됩니다. 폴더가 다 차면 다음에 저장한 문자 메시지가 폴더에서 가장 오래된 문자 메시지를 자동으로 대체합니다.

저장된 문자 메시지 보기



다음 절차에 따라 무전기에서 저장된 문자 메시지를 봅니다.

1 다음 중 하나를 수행합니다.



- 프로그래밍된 **문자 메시지** 버튼을 누릅니다. 단계 3로 진행합니다.
-  버튼을 눌러 메뉴로 이동합니다.

2  또는  버튼을 눌러 메시지로 이동합니다.

 버튼을 눌러 선택합니다.

3  또는  버튼을 눌러 임시보관함으로 이동

합니다.  버튼을 눌러 선택합니다.



4  또는  버튼을 눌러 원하는 메시지로 이동

합니다.  버튼을 눌러 선택합니다.

저장된 문자 메시지 편집

다음 절차에 따라 무전기에서 저장된 문자 메시지를 편집합니다.



1 메시지를 보는 동안  을 누릅니다.

2  또는  버튼을 눌러 편집합니다.  버튼
을 눌러 선택합니다.

깜박이는 커서가 나타납니다.

3 키패드를 사용하여 메시지를 입력합니다.

왼쪽으로 한 칸 이동하려면  버튼을 누릅니다.



오른쪽으로 한 칸 이동하려면  또는  버튼을
누릅니다.

필요 없는 문자를 삭제하려면  버튼을 누릅니
다.





문자 입력 방법을 변경하려면  버튼을 길게 누
릅니다.

4 메시지를 작성했으면  버튼을 누릅니다.

다음 중 하나를 수행합니다.

-  또는  을 눌러 전송으로 이동합니다.



 버튼을 눌러 메시지를 보냅니다.



-  를 누릅니다.  또는  버튼을 눌러
메시지를 저장하거나 삭제합니다.  버튼을 누
러 선택합니다.



임시 보관함 폴더에 저장된 문자 메시지 삭제



다음 절차에 따라 무전기에서 임시 보관함에 저장된 문자 메시지를 삭제합니다.

- 다음 중 하나를 수행합니다.
 - 프로그래밍된 **문자 메시지** 버튼을 누릅니다. **단계 3**로 진행합니다.
 -  버튼을 눌러 메뉴로 이동합니다.

-  또는  버튼을 눌러 메시지로 이동합니다.
 버튼을 눌러 선택합니다.

-  또는  버튼을 눌러 임시보관함으로 이동합니다.  버튼을 눌러 선택합니다.

-  또는  버튼을 눌러 원하는 메시지로 이동합니다.  버튼을 눌러 선택합니다.

-  또는  버튼을 눌러 삭제로 이동합니다.
 을 눌러 문자 메시지를 삭제합니다.

단축 문자 메시지

무전기는 대리점에서 프로그래밍한 대로 최대 50개의 단축 문자 메시지를 지원합니다.



단축 문자 메시지를 미리 정의한 경우 전송하기 전에 각 메시지를 편집할 수 있습니다.

단축 문자 메시지 전송



다음 절차에 따라 무전기에서 사전 정의된 별칭으로 사전 정의된 단축 문자 메시지를 전송합니다.



- 다음 중 하나를 수행합니다.
 - 프로그래밍된 **문자 메시지** 버튼을 누릅니다. **단계 3**로 진행합니다.
 - 프로그래밍된 **원터치 액세스** 버튼을 누릅니다. **단계 6**로 진행합니다.
디스플레이에 전환 미니 알림이 표시되어 메시지가 전송 중임을 나타냅니다.

-  버튼을 눌러 메뉴로 이동합니다.

- 2  또는  버튼을 눌러 메시지로 이동합니다.

 버튼을 눌러 선택합니다.

- 3  또는  버튼을 눌러 단축 문자로 이동합니다.  버튼을 눌러 선택합니다.

- 4  또는  버튼을 눌러 원하는 단축 문자 메시지로 이동합니다.  버튼을 눌러 선택합니다.

- 5 다음을 수행하여 수신자를 선택하고 메시지를 전송합니다.

디스플레이에 전환 미니 알림이 표시되어 메시지가 전송 중임을 나타냅니다.

- 6 승인을 기다립니다.

성공 시:

- 선택음이 울립니다.
- 디스플레이에 선택 미니 알림이 표시됩니다.

실패 시:

- 해제음이 울립니다.
- 디스플레이에 해제 미니 알림이 표시됩니다.
- 무전기가 재전송 옵션 화면으로 이동합니다. 자세한 내용은 [문자 메시지 재전송 페이지의 139](#) 부분을 참조하십시오.

텍스트 입력 구성

무전기에서 다른 문자를 구성할 수 있습니다.

무전기에서 다음과 같은 텍스트 입력 설정을 구성할 수 있습니다.

- 단어 예측
- 단어 교정
- 대문자
- 나의 단어

무전기에서는 다음 텍스트 입력 방법을 지원합니다.

- 숫자
- 기호
- 자동 완성 또는 여러 번 누름

- 언어(프로그래밍된 경우)



주의:

이전 화면으로 돌아가려면 언제든지 버튼을 누르고, 홈 화면으로 돌아가려면 버튼을 길게 누릅니다. 무전기는 비활성 타이머가 만료되는 즉시 현재 화면을 종료합니다.

단어교정 기능 활성화 또는 비활성화

텍스트 편집기에 입력한 단어가 내장된 사전에 없는 경우 대체 단어 옵션을 제공합니다.

- 버튼을 눌러 메뉴로 이동합니다.

- 또는 버튼을 눌러 유틸리티로 이동합니다. 버튼을 눌러 선택합니다.

- 또는 버튼을 눌러 무전기 설정으로 이동합니다. 버튼을 눌러 선택합니다.

- 또는 버튼을 눌러 문자 입력으로 이동합니다. 버튼을 눌러 선택합니다.

- 또는 버튼을 눌러 단어 교정으로 이동합니다. 버튼을 눌러 선택합니다.

- 다음 중 하나를 수행합니다.



- 또는 버튼을 눌러 단어 교정으로 이동합니다. 버튼을 눌러 선택합니다.
 - 버튼을 눌러 단어 교정 기능을 활성화합니다. 활성화되면 아이콘이 활성화 옆에 표시됩니다.
 - 버튼을 눌러 단어 교정 기능을 비활성화합니다. 비활성화되면 아이콘이 활성화 옆에서 사라집니다.
-



단어 예측 활성화 또는 비활성화



단어 예측: 무전기는 사용자가 자주 입력하는 흔하게 사용되는 단어 시퀀스를 기억할 수 있습니다. 이 기능을 통해 사용자가 흔하게 사용되는 단어 시퀀스 중 첫 번째 단어를 텍스트



트 편집기에 입력하면 다음에 입력할 단어를 무전기가 자동으로 예측할 수 있습니다.

- 1  버튼을 눌러 메뉴로 이동합니다.





- 2  또는  버튼을 눌러 유틸리티로 이동합니다.  버튼을 눌러 선택합니다.

- 3  또는  버튼을 눌러 무전기 설정으로 이동합니다.  버튼을 눌러 선택합니다.

- 4  또는  버튼을 눌러 문자 입력으로 이동합니다.  버튼을 눌러 선택합니다.

- 5  또는  을 눌러 단어 예측으로 이동합니다.  버튼을 눌러 선택합니다.



- 6 다음 중 하나를 수행합니다.



-  버튼을 눌러 단어 예측 기능을 활성화합니다. 활성화되면  아이콘이 활성화 옆에 표시됩니다.
-  을 눌러 마이크 동적 왜곡 컨트롤을 비활성화합니다. 비활성화되면  아이콘이 활성화 옆에서 사라집니다.



대문자



이 기능은 문장을 새로 시작할 때 첫 번째 단어의 첫 문자를 자동으로 대문자로 표시할 때 사용됩니다.

- 1  버튼을 눌러 메뉴로 이동합니다.





- 2  또는  버튼을 눌러 유틸리티로 이동합니다.  버튼을 눌러 선택합니다.

- 3  또는  버튼을 눌러 무전기 설정으로 이동합니다.  버튼을 눌러 선택합니다.

4  또는  버튼을 눌러 문자 입력으로 이동합니다.  버튼을 눌러 선택합니다.

5  또는  버튼을 눌러 대문자로 이동합니다.  버튼을 눌러 선택합니다.



6 다음 중 하나를 수행합니다.



-  버튼을 눌러 대문자 기능을 활성화합니다. 활성화되면  아이콘이 활성화 옆에 표시됩니다.
 -  버튼을 눌러 대문자 기능을 비활성화합니다. 비활성화되면  아이콘이 활성화 옆에서 사라집니다.
-



사용자 지정 단어 보기



무전기의 내장된 사전에 사용자 지정 단어를 추가할 수 있습니다. 무전기에는 이러한 사용자 지정 단어를 저장하는 목록이 포함되어 있습니다.



1  버튼을 눌러 메뉴로 이동합니다.

2  또는  버튼을 눌러 유틸리티로 이동합니다.  버튼을 눌러 선택합니다.

3  또는  버튼을 눌러 무전기 설정으로 이동합니다.  버튼을 눌러 선택합니다.

4  또는  버튼을 눌러 문자 입력으로 이동합니다.  버튼을 눌러 선택합니다.



5  또는  버튼을 눌러 내 단어로 이동합니다.  버튼을 눌러 선택합니다.



6  또는  을 눌러 단어 목록으로 이동합니다.  버튼을 눌러 선택합니다. 디스플레이에 사용자 지정 단어 목록이 표시됩니다.



사용자 지정 단어 편집



무전기에 저장된 사용자 지정 단어를 편집할 수 있습니다.



- 1  버튼을 눌러 메뉴로 이동합니다.



- 2  또는  버튼을 눌러 유틸리티로 이동합니다.  버튼을 눌러 선택합니다.



- 3  또는  버튼을 눌러 무전기 설정으로 이동합니다.  버튼을 눌러 선택합니다.





- 4  또는  버튼을 눌러 문자 입력으로 이동합니다.  버튼을 눌러 선택합니다.

- 5  또는  버튼을 눌러 내 단어로 이동합니다.  버튼을 눌러 선택합니다.

- 6  또는  을 눌러 단어 목록으로 이동합니다.  버튼을 눌러 선택합니다.
디스플레이에 사용자 지정 단어 목록이 표시됩니다.

- 7  또는  을 눌러 원하는 단어로 이동합니다.  버튼을 눌러 선택합니다.

- 8  또는  을 눌러 편집으로 이동합니다.  버튼을 눌러 선택합니다.

- 9 키패드로 사용자 지정 단어를 편집합니다.
 - 왼쪽으로 한 칸 이동하려면  버튼을 누릅니다.
 - 오른쪽으로 한 칸 이동하려면  키를 누릅니다.
 - 필요 없는 문자를 삭제하려면  키를 누릅니다.
 - 문자 입력 방법을 변경하려면  버튼을 길게 누릅니다.

- 10 사용자 지정 단어를 완성한 후  버튼을 누릅니다.



디스플레이에 전환 미니 알림이 표시되어 사용자 지정 단어가 저장 중임을 나타냅니다.



- 사용자 지정 단어가 저장되면 경보음이 울리고 디스플레이에 선택 미니 알림이 표시됩니다.
- 사용자 지정 단어가 저장되지 않으면 낮은 경보음이 울리고 디스플레이에 해제 미니 알림이 표시됩니다.



사용자 지정 단어 추가



무전기에 내장된 사전에 사용자 지정 단어를 추가할 수 있습니다.

- 1  버튼을 눌러 메뉴로 이동합니다.



- 2  또는  버튼을 눌러 유틸리티로 이동합니다.  버튼을 눌러 선택합니다.

- 3  또는  버튼을 눌러 무전기 설정으로 이동합니다.  버튼을 눌러 선택합니다.

- 4  또는  버튼을 눌러 문자 입력으로 이동합니다.  버튼을 눌러 선택합니다.





5  또는  버튼을 눌러 내 단어로 이동합니다.

 버튼을 눌러 선택합니다.

6  또는  을 눌러 새 단어 추가로 이동합니다.  버튼을 눌러 선택합니다.

디스플레이에 사용자 지정 단어 목록이 표시됩니다.

7 키패드로 사용자 지정 단어를 편집합니다.

- 왼쪽으로 한 칸 이동하려면  버튼을 누릅니다.
 - 오른쪽으로 한 칸 이동하려면  키를 누릅니다.
 - 필요 없는 문자를 삭제하려면  키를 누릅니다.
 - 문자 입력 방법을 변경하려면  버튼을 길게 누릅니다.
-

- 8 사용자 지정 단어를 완성한 후  버튼을 누릅니다.



디스플레이에 전환 미니 알림이 표시되어 사용자가 지정 단어가 저장 중임을 나타냅니다.



- 사용자 지정 단어가 저장되면 경보음이 울리고 디스플레이에 선택 미니 알림이 표시됩니다.
- 사용자 지정 단어가 저장되지 않으면 낮은 경보음이 울리고 디스플레이에 해제 미니 알림이 표시됩니다.



사용자 지정 단어 삭제



다음 절차에 따라 무전기에 저장된 사용자 지정 단어를 삭제합니다.



- 1  버튼을 눌러 메뉴로 이동합니다.



- 2  또는  버튼을 눌러 유틸리티로 이동합니다.  버튼을 눌러 선택합니다.

- 3  또는  버튼을 눌러 무전기 설정으로 이동합니다.  버튼을 눌러 선택합니다.





- 4  또는  버튼을 눌러 문자 입력으로 이동합니다.  버튼을 눌러 선택합니다.

- 5  또는  버튼을 눌러 내 단어로 이동합니다.  버튼을 눌러 선택합니다.

- 6  또는  을 눌러 원하는 단어로 이동합니다.  버튼을 눌러 선택합니다.

- 7  또는  버튼을 눌러 삭제로 이동합니다.  버튼을 눌러 선택합니다.



- 8 다음 중 하나를 선택합니다.



- 항목 삭제?에서  을 눌러 예를 선택합니다. 디스플레이에 항목 삭제 완료가 표시됩니다.
-  또는  버튼을 눌러 아니오로 이동합니다. 이전 화면으로 돌아가려면  버튼을 누릅니다.



사용자 지정 단어 전체 삭제



다음 절차를 따라 무전기의 내장 사전에서 모든 사용자 지정 단어를 삭제합니다.



- 1  버튼을 눌러 메뉴로 이동합니다.

- 2  또는  버튼을 눌러 유틸리티로 이동합니다.  버튼을 눌러 선택합니다.





- 3  또는  버튼을 눌러 무전기 설정으로 이동합니다.  버튼을 눌러 선택합니다.

- 4  또는  버튼을 눌러 문자 입력으로 이동합니다.  버튼을 눌러 선택합니다.

- 5  또는  버튼을 눌러 내 단어로 이동합니다.  버튼을 눌러 선택합니다.

- 6  또는  버튼을 눌러 전체 삭제로 이동합니다.  버튼을 눌러 선택합니다.

- 7 다음 중 하나를 수행합니다.

- 항목 삭제?에서  을 눌러 예를 선택합니다. 디스플레이에 모든 항목 삭제 완료가 표시됩니다.
-  또는  버튼을 누르고 아니오를 선택하여 이전 화면으로 돌아갑니다.  버튼을 눌러 선택합니다.

작업 티켓

이 기능을 사용하면 수행할 작업이 나열된 디스패처의 메시지를 받을 수 있습니다.



주의:

이 기능은 사용자 요구 사항에 따라 CPS를 통해 지정할 수 있습니다. 자세한 내용은 대리점이나 시스템 관리자에게 문의하십시오.

다음과 같이 서로 다른 작업 티켓을 포함하는 두 개의 폴더가 있습니다.

내 작업 폴더

로그인한 사용자 ID에 지정된 개인 작업 티켓.

공유 작업 폴더

개인 그룹에 할당된 공유 작업 티켓.

작업 티켓을 작업 티켓 폴더로 정렬하기 위해 작업 티켓에 응답할 수 있습니다. 기본적으로 작업 티켓 폴더는 **전체**, **신규**, **시작됨** 및 **완료됨**입니다. 10개의 추가 폴더에 대해서는 대리점이나 시스템 관리자에게 문의하십시오.



주의:

작업 티켓은 무전기를 껐다가 다시 켜 후에도 유지됩니다.

모든 작업 티켓은 **모든 폴더**에 있습니다. 무전기가 프로그램된 방식에 따라, 작업 티켓은 우선순위 레벨에 따라 정렬된 다음, 수신된 시간을 기준으로 정렬됩니다. 새로운 작업 티켓, 최근 상태 변경이 있는 작업 티켓, 우선순위가 가장 높은 작업 티켓이 먼저 나열됩니다. 최대 작업 티켓 수에 도달하면 무전기의 마지막 작업 티켓이 다음 작업 티켓으로 자동으로 바뀝니다. 무전기는 모델에 따라 최대 100개 또는 500개의 작업 티켓을 지원합니다. 자세한 내용은 대리점이나 시스템 관리자에게 문의하십시오. 무전기는 작업 티켓 ID가 같은 중복된 작업 티켓을 자동으로 감지하고 취소합니다.

작업 티켓의 중요성에 따라 디스패처는 작업 티켓에 우선순위 레벨을 추가합니다. 다음과 같은 세 가지 우선순위 레벨이 있습니다. 우선순위 1, 우선순위 2 및 우선순위 3. 우선순

위 1이 가장 높은 우선순위이고 우선순위 3이 가장 낮은 우선순위입니다. 우선순위가 없는 작업 티켓도 있습니다.

디스패처가 다음과 같이 변경하면 무전기가 업데이트됩니다.

- 작업 티켓의 내용을 수정합니다.
- 작업 티켓의 우선순위 레벨을 추가하거나 편집합니다.
- 작업 티켓을 폴더에서 폴더로 이동합니다.
- 작업 티켓을 취소합니다.



작업 티켓 폴더에 액세스



다음 절차에 따라 작업 티켓 폴더에 액세스합니다.

1 다음 중 하나를 수행합니다.



- 프로그래밍된 **작업 티켓** 버튼을 누릅니다. **단계 3**로 진행합니다.
-  버튼을 눌러 메뉴로 이동합니다.

2

-  또는  을 눌러 작업 티켓으로 이동합니다.
-  버튼을 눌러 선택합니다.

3  또는  을 눌러 원하는 폴더로 이동합니다.

 버튼을 눌러 선택합니다.



4  또는  을 눌러 원하는 작업 티켓으로 이동

합니다.  버튼을 눌러 선택합니다.

원격 서버의 로그인 또는 로그아웃

이 기능을 사용하면 사용자 ID를 사용하여 원격 서버에 로그인하고 로그아웃할 수 있습니다.

1  버튼을 눌러 메뉴로 이동합니다.

2  또는  을 눌러 로그인으로 이동합니다.

 버튼을 눌러 선택합니다.

이미 로그인한 경우 메뉴에 로그아웃이 표시됩니다.

디스플레이에 전환 미니 알림이 표시되어 요청이 진행 중임을 나타냅니다.

3 승인을 기다립니다.

성공 시:

- 선택음이 울립니다.
- 디스플레이에 선택 미니 알림이 표시됩니다.

실패 시:



- 해제음이 울립니다.
 - 디스플레이에 해제 미니 알림이 표시됩니다.
-

작업 티켓 작성



무전에서 작업 티켓을 작성할 수 있습니다. 작업 티켓은 작업 티켓 템플릿에 기반하며, 수행해야 하는 작업을 전송합니다.

작업 티켓 템플릿을 구성하려면 CPS 프로그래밍 소프트웨어가 필요합니다.

1  버튼을 눌러 메뉴로 이동합니다.











2  또는  을 눌러 작업 티켓으로 이동합니다.

 버튼을 눌러 선택합니다.



- 3  또는  버튼을 눌러 티켓 작성으로 이동합니다.  버튼을 눌러 선택합니다.

작업 티켓에 응답

다음 절차에 따라 무전기에서 작업 티켓에 응답합니다.

- 1  버튼을 눌러 메뉴로 이동합니다.
- 2  또는  을 눌러 작업 티켓으로 이동합니다.  버튼을 눌러 선택합니다.
- 3  또는  을 눌러 원하는 폴더로 이동합니다.  버튼을 눌러 선택합니다.
- 4  또는  을 눌러 원하는 작업 티켓으로 이동합니다.  버튼을 눌러 선택합니다.
- 5  버튼을 한 번 더 눌러 하위 메뉴로 이동합니다.

해당 숫자 키(1-9)를 눌러 **단축 회신**으로 이동할 수도 있습니다.

- 6  또는  을 눌러 원하는 작업 티켓으로 이동합니다.  버튼을 눌러 선택합니다.
- 디스플레이에 전환 미니 알림이 표시되어 요청이 진행 중임을 나타냅니다.

- 7 승인을 기다립니다.

성공 시:

- 선택음이 울립니다.
- 디스플레이에 선택 미니 알림이 표시됩니다.



실패 시:



- 해제음이 울립니다.
- 디스플레이에 해제 미니 알림이 표시됩니다.



하나의 작업 티켓 템플릿을 사용하여 작업 티켓 전송

하나의 작업 티켓 템플릿으로 무전기를 구성한 경우 다음 작업을 수행하여 작업 티켓을 전송합니다.

1 키패드를 사용하여 원하는 호실을 입력합니다.  버튼을 눌러 선택합니다.

2  또는  을 눌러 방 상태로 이동합니다.  버튼을 눌러 선택합니다.

3  또는  버튼을 눌러 원하는 옵션으로 이동합니다.  버튼을 눌러 선택합니다.



4  또는  을 눌러 전송으로 이동합니다.  버튼을 눌러 선택합니다.
디스플레이에 전환 미니 알림이 표시되어 요청이 진행 중임을 나타냅니다.



5 승인을 기다립니다.
성공 시:

- 선택음이 울립니다.
 - 디스플레이에 선택 미니 알림이 표시됩니다.
- 실패 시:
- 해제음이 울립니다.
 - 디스플레이에 해제 미니 알림이 표시됩니다.

둘 이상의 작업 티켓 템플릿을 사용하여 작업 티켓 전송

둘 이상의 작업 티켓 템플릿으로 무전기를 구성했으면 다음 작업을 수행하여 작업 티켓을 전송합니다.

1  또는  버튼을 눌러 원하는 옵션으로 이동합니다.  버튼을 눌러 선택합니다.

2  또는  을 눌러 전송으로 이동합니다.  버튼을 눌러 선택합니다.
디스플레이에 전환 미니 알림이 표시되어 요청이 진행 중임을 나타냅니다.

3 승인을 기다립니다.

성공 시:

- 선택음이 울립니다.
- 디스플레이에 선택 미니 알림이 표시됩니다.

실패 시:

















- 해제음이 울립니다.
- 디스플레이에 해제 미니 알림이 표시됩니다.

작업 티켓 삭제

다음 절차에 따라 무전기에서 작업 티켓을 삭제합니다.

1 다음 중 하나를 수행합니다.

- 프로그래밍된 **작업 티켓** 버튼을 누릅니다. **단계 4**로 진행합니다.
-  버튼을 눌러 메뉴로 이동합니다.

2  또는  을 눌러 작업 티켓으로 이동합니다. 버튼을 눌러 선택합니다.**3**  또는  을 눌러 원하는 폴더로 이동합니다. 버튼을 눌러 선택합니다.**4**  또는  버튼을 눌러 모든 폴더로 이동합니다. 버튼을 눌러 선택합니다.**5**  또는  을 눌러 원하는 작업 티켓으로 이동합니다. 버튼을 눌러 선택합니다.**6** 작업 티켓을 보는 동안  버튼을 다시 한 번 누릅니다.**7**  또는  버튼을 눌러 삭제로 이동합니다. 버튼을 눌러 선택합니다.

디스플레이에 전환 미니 알림이 표시되어 요청이 진행 중임을 나타냅니다.

8 승인을 기다립니다.



성공 시:



- 선택음이 울립니다.
 - 디스플레이에 선택 미니 알림이 표시됩니다.
- 실패 시:
- 해제음이 울립니다.
 - 디스플레이에 해제 미니 알림이 표시됩니다.



모든 작업 티켓 삭제



다음 절차에 따라 무전기에서 모든 작업 티켓을 삭제합니다.

- 1 다음 중 하나를 수행합니다.
 - 프로그래밍된 **작업 티켓** 버튼을 누릅니다. **단계 3**로 진행합니다.
 -  버튼을 눌러 메뉴로 이동합니다.







- 2  또는  을 눌러 작업 티켓으로 이동합니다.
 버튼을 눌러 선택합니다.

- 3  또는  을 눌러 원하는 폴더로 이동합니다.
 버튼을 눌러 선택합니다.

- 4  또는  버튼을 눌러 모든 폴더로 이동합니다.
 버튼을 눌러 선택합니다.

- 5  또는  버튼을 눌러 전체 삭제로 이동합니다.
 버튼을 눌러 선택합니다.

- 6 다음 중 하나를 수행합니다.

-  또는  버튼을 눌러 예를 선택합니다.
 버튼을 눌러 선택합니다.
디스플레이에 선택 미니 알림이 표시됩니다.
-  또는  버튼을 눌러 아니오로 이동합니다.
 버튼을 눌러 선택합니다.
무전기가 이전 화면으로 돌아옵니다.

개인 정보 보호

이 기능은 무단 사용자가 소프트웨어 기반 스크램블링 솔루션을 사용하여 채널에서 도청하는 것을 방지할 수 있습니다. 전송에 대한 신호 및 사용자 ID 부분은 스크램블링되지 않습니다.

프라이버시 활성화 전송을 보내려면 채널상에서 무전기의 프라이버시가 활성화되어 있어야 하지만, 이는 전송을 수신하기 위한 필수 사항은 아닙니다. 프라이버시 활성화 채널에서는 무전기가 깨끗하고 스크램블링되지 않은 전송을 계속 수신할 수 있습니다.

무전기는 고급 프라이버시만 지원합니다. 프라이버시 활성화 호출 또는 데이터 전송의 스크램블을 풀려면 고급 프라이버시에서 발신 무전기와 동일한 키 값과 키 ID를 사용하도록 무전기가 프로그래밍되어야 합니다.

무전기에서 다른 키 값과 키 ID를 사용한 스크램블링된 호출을 받는 경우에는 고급 프라이버시를 위해 아무것도 들리지 않습니다.

프라이버시 활성화 채널에서는 무전기가 프로그래밍된 방식에 따라 무전기가 깨끗하거나 스크램블링되지 않은 호출을 수신할 수 있습니다. 또한 무전기가 프로그래밍된 방식에 따라 무전기가 경고음을 울리거나 울리지 않을 수도 있습니다.



주의:

이 기능은 동일한 주파수에 있는 Citizens 대역 채널에는 적용되지 않습니다.

무전기가 전송 중이면 녹색 LED가 켜지고 무전기가 진행 중인 프라이버시 사용 전송을 수신 중이면 녹색 LED가 빠르게 깜박입니다.



주의:

일부 무전기 모델은 이러한 프라이버시 기능이 없거나 구성이 다를 수 있습니다. 자세한 내용은 대리점이나 시스템 관리자에게 문의하십시오.



프라이버시 기능 켜기 또는 끄기

다음 절차에 따라 무전기에서 프라이버시 기능을 켜거나 끕니다.



1 다음 중 하나를 수행합니다.



- 프로그래밍된 **프라이버시** 버튼을 누릅니다. 아래 단계를 건너뛴니다.
-  버튼을 눌러 메뉴로 이동합니다.

2



-  또는  버튼을 눌러 유틸리티로 이동합니다.  버튼을 눌러 선택합니다.



3

-  또는  버튼을 눌러 무전기 설정으로 이동합니다.  버튼을 눌러 선택합니다.

4  또는  버튼을 눌러 프라이버시로 이동합니다.  버튼을 눌러 선택합니다.

5 다음 중 하나를 수행합니다.

•  또는  버튼을 눌러 켜기로 이동합니다.  버튼을 눌러 선택합니다. ✓가 디스플레이의 켜기 옆에 표시됩니다.

•  또는  버튼을 눌러 끄기로 이동합니다.  버튼을 눌러 선택합니다. ✓가 디스플레이의 끄기 옆에 표시됩니다.

응답 금지

이 기능을 사용하면 수신되는 어떤 전송에도 무전기가 응답하지 않도록 해줍니다.



주의:

이 기능은 유료입니다. 무전기가 프로그래밍된 방식에 대해서는 대리점이나 시스템 관리자에게 문의하십시오.

이 기능을 사용하면 무전기에서 무전기 점검, 호출 경보, 무선 비활성화, 원격 모니터링, 자동 등록 서비스(ARS), 비공

개 메시지 응답, GNSS 위치 보고서 전송 등과 같이 수신되는 전송에 응답하여 전송을 발송하지 않습니다. 이 기능을 사용하면 무전기가 확인된 개인 통화를 받지 않을 수 있습니다. 하지만 무전기에서 수동으로 전송 내역을 보낼 수 있습니다.

응답 금지 켜기 또는 끄기

다음 절차에 따라 무전기의 응답 금지를 활성화하거나 비활성화할 수 있습니다.

프로그래밍된 **응답 금지** 버튼을 누릅니다.

성공 시:

- 선택음이 울립니다.
- 디스플레이에 선택 미니 알림이 일시적으로 표시됩니다.

실패 시:

- 해제음이 울립니다.
- 디스플레이에 해제 미니 알림이 일시적으로 표시됩니다.

사용 중지/복구

이 기능을 사용하여 시스템의 무전기를 활성화하거나 비활성화할 수 있습니다. 예를 들어, 판매점이나 시스템 관리자

가 다른 사용자들이 무단으로 사용할 수 없도록 도난당한 무전기를 비활성화한 후, 무전기를 되찾았을 때 활성화할 수 있습니다.

콘솔이나 다른 무전기에서 실행한 명령어를 통해 무전기를 비활성화하거나 활성화할 수 있습니다.

무전기가 비활성화되면 무전기 해제음이 울리고 홈 화면에 채널 거부됨이 표시됩니다.

무전기가 사용 중지되면 무전기는 사용 중지 절차를 수행한 시스템에서 사용자가 시작한 서비스를 요청하거나 수신할 수 없습니다. 그러나 무전기를 다른 시스템으로 전환할 수 있습니다. 사용 중지되었을 때 무전기는 **GNSS** 위치 보고서를 계속 전송하고 원격으로 모니터링할 수 있습니다.





주의:

판매점이나 시스템 관리자가 무전기를 영구적으로 비활성화할 수 있습니다. 자세한 내용은 [무선 연결 끊김 페이지의 171](#) 부분을 참조하십시오.

무전기 사용 중지

다음 절차에 따라 무전기를 비활성화합니다.

- 1 프로그래밍된 **무전기 비활성화** 버튼을 누릅니다.

- 2  또는  버튼을 눌러 원하는 별칭 또는 ID로 이동합니다.  버튼을 눌러 선택합니다.

디스플레이에 전환 미니 알림이 표시되어 요청이 진행 중임을 나타냅니다. 녹색 LED가 깜박입니다.

- 3 승인을 기다립니다.

성공 시:

- 선택음이 울립니다.
- 디스플레이에 선택 미니 알림이 표시됩니다.



실패 시:

- 해제음이 울립니다.
- 디스플레이에 해제 미니 알림이 표시됩니다.



연락처 목록을 사용하여 무전기 사용 중지

다음 절차에 따라 연락처 목록을 사용하여 무전기를 비활성화합니다.



- 1  버튼을 눌러 메뉴로 이동합니다.

2  또는  버튼을 눌러 연락처로 이동합니다.

 버튼을 눌러 선택합니다.

3  또는  버튼을 눌러 원하는 별칭 또는 ID로

이동합니다.  버튼을 눌러 선택합니다.

4  또는  버튼을 눌러 무전기 비활성화로 이

동합니다.  버튼을 눌러 선택합니다.

디스플레이에 전환 미니 알림이 표시되어 요청이 진행 중임을 나타냅니다. 녹색 LED가 깜박입니다.

5 승인을 기다립니다.

성공 시:

- 선택음이 울립니다.
- 디스플레이에 선택 미니 알림이 표시됩니다.

실패 시:

- 해제음이 울립니다.
- 디스플레이에 해제 미니 알림이 표시됩니다.



매뉴얼 다이얼을 사용하여 무전기 사용 중 지



다음 절차에 따라 매뉴얼 다이얼을 사용하여 무전기를 비활성화합니다.

1  버튼을 눌러 메뉴로 이동합니다.

2  또는  버튼을 눌러 연락처로 이동합니다.



 버튼을 눌러 선택합니다.

3  또는  버튼을 눌러 매뉴얼 다이얼로 이동합니다.  버튼을 눌러 선택합니다.

4  또는  버튼을 눌러 무전기 번호를 선택합니다.  버튼을 눌러 선택합니다.

첫 번째 텍스트 줄에 무전기 번호:가 표시됩니다.

5 가입자 ID를 입력하고  버튼을 눌러 계속합니다.

- 6  또는  버튼을 눌러 무전기 비활성화로 이동합니다.  버튼을 눌러 선택합니다.
디스플레이에 전환 미니 알림이 표시되어 요청이 진행 중임을 나타냅니다. 녹색 LED가 깜박입니다.



7 승인을 기다립니다.

성공 시:

- 선택음이 울립니다.
- 디스플레이에 선택 미니 알림이 표시됩니다.

실패 시:

- 해제음이 울립니다.
- 디스플레이에 해제 미니 알림이 표시됩니다.

- 2  또는  버튼을 눌러 원하는 별칭 또는 ID로 이동합니다.  버튼을 눌러 선택합니다.
디스플레이에 무전기 활성화와 가입자 별칭 또는 ID가 표시됩니다. 녹색 LED가 켜집니다.

3 승인을 기다립니다.

성공 시:

- 선택음이 울립니다.
- 디스플레이에 선택 미니 알림이 표시됩니다.

실패 시:

- 해제음이 울립니다.
- 디스플레이에 해제 미니 알림이 표시됩니다.

무전기 복구



다음 절차에 따라 무전기를 활성화합니다.

- 1 프로그래밍된 **무전기 활성화** 버튼을 누릅니다.



연락처 목록을 사용하여 무전기 복구

다음 절차에 따라 연락처 목록을 사용하여 무전기를 활성화합니다.



- 1  버튼을 눌러 메뉴로 이동합니다.

2  또는  버튼을 눌러 연락처로 이동합니다.

 버튼을 눌러 선택합니다.

3  또는  버튼을 눌러 원하는 별칭 또는 ID로

이동합니다.  버튼을 눌러 선택합니다.

4  또는  버튼을 눌러 무전기 활성화로 이동

합니다.  버튼을 눌러 선택합니다.

녹색 LED가 깜박입니다.

디스플레이에 무전기 활성화와 가입자 별칭 또는 ID가 표시됩니다. 녹색 LED가 켜집니다.

5 승인을 기다립니다.

성공 시:

- 신호음이 울립니다.
- 디스플레이에 무전기 활성화 성공이 표시됩니다.

실패 시:



- 신호음이 울립니다.

- 디스플레이에 무전기 활성화 실패가 표시됩니다.



매뉴얼 다이얼을 사용하여 무전기 복구

다음 절차에 따라 매뉴얼 다이얼을 사용하여 무전기를 활성화합니다.



1  버튼을 눌러 메뉴로 이동합니다.

2  또는  버튼을 눌러 연락처로 이동합니다.

 버튼을 눌러 선택합니다.

3  또는  버튼을 눌러 매뉴얼 다이얼로 이동



합니다.  버튼을 눌러 선택합니다.

4  또는  을 눌러 개별 호출로 이동합니다.

 버튼을 눌러 선택합니다.

첫 번째 텍스트 줄에 무전기 번호:가 표시됩니다.

5 가입자 ID를 입력하고  버튼을 눌러 계속합니다.

6  또는  버튼을 눌러 무전기 활성화로 이동합니다.  버튼을 눌러 선택합니다.

녹색 LED가 깜박입니다.

디스플레이에 무전기 복구와 가입자 별칭 또는 ID가 표시됩니다. 녹색 LED가 켜집니다.

7 승인을 기다립니다.

성공 시:

- 신호음이 울립니다.
- 디스플레이에 무전기 복구 성공이 표시됩니다.

실패 시:

- 신호음이 울립니다.
- 디스플레이에 무전기 복구 실패가 표시됩니다.

무선 연결 끊김

이 기능은 무전기에 대한 무단 접근을 차단하여 보안 조치를 강화합니다.

무선 연결 끊김으로 인해 무전기의 작동 불능을 초래할 수 있습니다. 예를 들어, 판매점이나 시스템 관리자가 무단 사용을 막기 위해 도난당하거나 잘못 배치한 무전기의 무선 연결을 끊을 수 있습니다.

전원을 켜면 무선 연결이 끊긴 무전기 화면에 무선 연결 끊김이 잠깐 동안 표시되어 무선 연결이 끊긴 상태임을 나타냅니다.



주의:

무선 연결이 끊긴 무전기는 **Motorola Solutions** 서비스 부서에서만 복원할 수 있습니다. 자세한 내용은 대리점이나 시스템 관리자에게 문의하십시오.

단독 작업자

이 기능은 무전기 버튼을 누르거나 채널 선택과 같은 동작을 미리 정해진 시간 동안 사용자가 하지 않으면 비상 상태임을 알립니다.

프로그래밍된 기간 동안 사용자 활동이 없는 경우, 무전기는 비활성 타이머가 만료되는 즉시 상태 표시음을 통해 사용자에게 사전 경고를 보냅니다.

미리 정해진 알람 타이머가 만료될 때까지도 사용자가 승인하지 않으면 무전기는 대리점이나 시스템 관리자가 프로그래밍한 대로 비상 상황이 시작됩니다.

자세한 내용은 **비상 작동 페이지의 123** 부분을 참조하십시오.



주의:

자세한 내용은 대리점이나 시스템 관리자에게 문의하십시오.

비밀번호 잠금 기능

이 기능을 사용하면 장치를 켜올 때 암호를 물어 무전기 액세스 권한을 제한할 수 있습니다.

키패드 마이크 또는 **위로 스크롤/아래로 스크롤** 버튼을 사용하여 암호를 입력할 수 있습니다.

비밀번호를 사용하여 무전기에 액세스



다음 절차에 따라 암호를 사용하여 무전기에 액세스합니다.

- 1 현재 4자리 비밀번호를 입력합니다.



주의:

비상 풋 스위치를 사용하면 무전기에 액세스하기 위한 암호 입력이 취소됩니다.

- 키패드 마이크를 사용합니다.
-  또는  버튼을 눌러 각 자리의 숫자 값을 편집한 다음  버튼을 눌러 입력하고 다음 자리로 이동합니다.

2

-  버튼을 눌러 비밀번호를 입력합니다.

성공하면 무전기 전원이 켜집니다.

실패 시:

- 첫 번째 및 두 번째 시도가 실패하면 디스플레이에 암호 불일치가 표시됩니다. **단계 1** 단계를 반복합니다.
- 세 번째 시도가 실패하면 디스플레이에 암호 불일치가 표시된 다음 무전기 잠금이 표시됩니다. 신호음이 울립니다. 노란색 LED가 2회 깜박입니다. 무전기가 15분 동안 잠금 상태가 됩니다.



주의:

잠금 상태에서 무전기는 **켜기/끄기/볼륨 조절** **노브** 및 프로그래밍된 **백라이트** 버튼 입력에만 응답합니다.

잠금 상태에서 무전기 잠금 해제

잠금 상태에서는 무전기가 호출을 수신할 수 없습니다. 다음 절차에 따라 잠금 상태에서 무전기 잠금을 해제합니다.



다음 중 하나를 수행합니다.



- 무전기 전원이 켜져 있으면 **15분** 동안 기다린 다음 **비밀번호를 사용하여 무전기에 액세스 페이지의 172**의 단계를 반복하여 무전기에 액세스합니다.
- 무전기 전원이 꺼지면 무전기 전원을 켭니다. 잠금 상태 시 **15분** 타이머가 다시 시작됩니다. 신호음이 울립니다. 노란색 LED가 **2회** 깜박입니다. 디스플레이에 무전기 잠금이 표시됩니다.
15분 동안 기다린 다음 **비밀번호를 사용하여 무전기에 액세스 페이지의 172**의 단계를 반복하여 무전기에 액세스합니다.



비밀번호 잠금 켜기 또는 끄기

다음 절차에 따라 무전기에서 비밀번호 잠금을 켜거나 끕니다.



- 1  버튼을 눌러 메뉴로 이동합니다.

- 2  또는  버튼을 눌러 유틸리티로 이동합니다.  버튼을 눌러 선택합니다.

- 3  또는  버튼을 눌러 무전기 설정으로 이동합니다.  버튼을 눌러 선택합니다.







- 4  또는  버튼을 눌러 암호 잠금으로 이동합니다.  버튼을 눌러 선택합니다.

- 5 현재 **4**자리 비밀번호를 입력합니다.

- 키패드 마이크를 사용합니다.
-  또는  버튼을 눌러 각 자리의 숫자 값을 편집한 다음  버튼을 눌러 입력하고 다음 자리로 이동합니다. 각 자리를 누를 때마다 선택음이 울립니다.







- 6  버튼을 눌러 비밀번호를 입력합니다. 비밀번호가 틀리면 디스플레이에 비밀번호 불일치가 표시되고 자동으로 이전 메뉴로 돌아갑니다.



7 다음 중 하나를 수행합니다.

-  또는  버튼을 눌러 켜기로 이동합니다.
 버튼을 눌러 선택합니다.
 ✓가 디스플레이의 켜기 옆에 표시됩니다.
-  또는  버튼을 눌러 끄기로 이동합니다.
 버튼을 눌러 선택합니다.
 ✓가 디스플레이의 끄기 옆에 표시됩니다.



비밀번호 변경

다음 절차에 따라 무전기에서 암호를 변경합니다.

- 1  버튼을 눌러 메뉴로 이동합니다.
- 2  또는  버튼을 눌러 유틸리티로 이동합니다.  버튼을 눌러 선택합니다.
- 3  또는  버튼을 눌러 무전기 설정으로 이동합니다.  버튼을 눌러 선택합니다.

4  또는  버튼을 눌러 암호 잠금으로 이동합니다.  버튼을 눌러 선택합니다.

5 현재 4자리 암호를 입력하고  버튼을 눌러 계속합니다.
 비밀번호가 틀리면 디스플레이에 비밀번호 불일치가 표시되고 자동으로 이전 메뉴로 돌아갑니다.

6  또는  버튼을 눌러 암호 변경으로 이동합니다.  버튼을 눌러 선택합니다.

7 4자리 새 암호를 입력하고  버튼을 눌러 계속합니다.

8 4자리 새 암호를 다시 입력하고  버튼을 눌러 계속합니다.
 성공한 경우 디스플레이에 암호 변경 완료가 표시됩니다.
 실패한 경우 디스플레이에 암호 일치하지 않음이 표시됩니다.

화면이 자동으로 이전 메뉴로 돌아갑니다.

알림 목록

무전기에는 채널에서 읽지 않은 문자 메시지, 텔리메트리 메시지, 부재중 수신통화, 호출 경보 등의 읽지 않은 모든 이벤트를 수집하는 알림 목록이 있습니다.

알림 목록에 하나 이상의 이벤트가 있는 경우 디스플레이에 **알림** 아이콘이 표시됩니다.



목록은 최대 40개의 읽지 않은 이벤트를 지원하며 목록이 가득 차면 다음 이벤트가 가장 오래된 이벤트를 자동으로 대체합니다. 읽은 이벤트는 알림 목록에서 제거됩니다.

문자 메시지, 부재 중 호출, 호출 경보 이벤트의 경우 알림의 최대 수는 문자 메시지 30개와 부재 중 호출 또는 호출 경보 10개입니다. 이 최대 수는 개별 기능(작업 티켓이나 문자 메시지 또는 부재중 호출/호출 경보)의 목록 기능에 따라 달라집니다.



알림 목록에 액세스

다음 절차에 따라 무전기에서 알림 목록에 액세스합니다.

- 1  버튼을 눌러 메뉴로 이동합니다.

- 2  또는  버튼을 눌러 알림으로 이동합니다.

 버튼을 눌러 선택합니다.

- 3  또는  버튼을 눌러 원하는 이벤트로 이동합니다.  버튼을 눌러 선택합니다.

홈 화면으로 돌아가려면  버튼을 길게 누릅니다.

OTAP(무선 프로그래밍)

물리적으로 연결하지 않아도 OTAP(무선 프로그래밍)를 통해 대리점에서 무전기를 원격으로 업데이트할 수 있습니다. 또한 OTAP를 통해 일부 설정을 구성할 수도 있습니다.

무전기에서 OTAP가 진행 중일 경우 녹색 LED가 깜박입니다.

무전기에서 대용량 데이터를 수신 중이면:

- 디스플레이에 **대용량 데이터** 아이콘이 표시됩니다.
- 채널이 사용 중 모드가 됩니다.
- **PTT** 버튼을 누르면 실패음이 울립니다.

구성에 따라 OTAP가 완료되면:

- 신호음이 울립니다. 디스플레이에 업데이트 재시작 중이 표시됩니다. 전원이 꺼졌다 다시 켜지며 무전기가 다시 시작됩니다.
- 지금 재시작 또는 연기를 선택할 수 있습니다. 지연을 선택하면 무전기가 이전 화면으로 돌아갑니다. 자동으로 재시작되기 전까지 디스플레이에 **OTAP 지연 타이머** 아이콘이 표시됩니다.

자동 재시작 후 무전기 전원이 켜지면:

- 성공한 경우 디스플레이에 소프트웨어 업데이트 완료가 표시됩니다.
- 실패한 경우 디스플레이에 소프트웨어 업데이트 실패가 표시됩니다.

업데이트된 소프트웨어 버전에 대해서는 [소프트웨어 업데이트 정보 확인 페이지의 207](#) 부분을 참조하십시오.



타사 주변 기기 연결 모드 선택



다음 절차에 따라 다음과 같은 타사 주변 기기 연결 모드 중 하나를 선택합니다.



- Motorola Solutions
- PC 및 오디오
- 데이터 액세스리



- 텔레메트리
- 일반

1  버튼을 눌러 메뉴로 이동합니다.

2  또는  버튼을 눌러 유틸리티로 이동합니다.  버튼을 눌러 선택합니다.

3  또는  버튼을 눌러 무전기 설정으로 이동합니다.  버튼을 눌러 선택합니다.

4  또는  버튼을 눌러 케이블 타입으로 이동합니다.  버튼을 눌러 선택합니다.

5  또는  버튼을 눌러 원하는 연결 모드로 이동합니다.  버튼을 눌러 선택합니다.

디스플레이에 선택된 연결 모드가 나타납니다. 화면이 이전 메뉴로 돌아갑니다.

수신 신호 강도 표시기

이 기능을 사용하여 RSSI(Received Signal Strength Indicator, 수신 신호 강도 표시기) 값을 확인할 수 있습니다.

디스플레이 오른쪽 상단에 **RSSI** 아이콘이 표시됩니다.

RSSI 아이콘에 대한 자세한 내용은 **디스플레이 아이콘** 부분을 참조하십시오.

RSSI 값 보기

4방향 탐색 키패드 마이크(Motorola Solutions 부품 번호: RMN5127_)를 무전기에 장착합니다.

홈 화면에서 4방향 탐색 키패드를 사용해 ◀ 버튼을 세 번 누르고 즉시 ▶ 버튼을 세 번 누릅니다.

디스플레이에 현재 RSSI 값이 표시됩니다.

홈 화면으로 돌아가려면 (↶) 버튼을 길게 누릅니다.

전면 패널 구성



무전기의 편리한 사용을 위해 전면 패널 구성(FPC)의 특정 기능 매개 변수를 사용자 정의할 수 있습니다.



전면 패널 구성 모드 들어가기

다음 절차에 따라 무전기에서 전면 패널 프로그래밍 모드에 들어갑니다.

홈 화면으로 돌아가려면 언제든지 (↶) 버튼을 길게 누릅니다.



- 1  버튼을 눌러 메뉴로 이동합니다.



- 2  또는  버튼을 눌러 유틸리티로 이동합니다.  버튼을 눌러 선택합니다.

- 3  또는  버튼을 눌러 무전기 프로그래밍으로 이동합니다.  버튼을 눌러 선택합니다.

FPP 모드 매개변수 편집

기능 매개 변수를 탐색하는 동안 필요할 때 다음 버튼을 사용합니다.

-   , - 옵션을 스크롤하거나, 값을 증가/감소시키거나, 세로로 탐색합니다.

-  - 옵션을 선택하거나 하위 메뉴로 진입합니다.
-  - 짧게 눌러 이전 메뉴로 돌아가거나 선택 화면을 종료합니다. 홈 화면으로 돌아가려면 길게 누릅니다.

Wi-Fi 작동

이 기능을 통해서 Wi-Fi 네트워크를 설정하고 연결할 수 있습니다. Wi-Fi는 무선 펌웨어, 코드플러그 및 언어 팩 및 음성 안내와 같은 리소스에 대한 업데이트를 지원합니다.

 **주의:**
이 기능은 XiR M8668i/CM7668i에만 적용됩니다.

Wi-Fi®는 Wi-Fi Alliance®의 등록 상표입니다.

본 무전기는 WEP/WPA/WPA2 개인용 및 WPA/WPA2 기업용 Wi-Fi 네트워크를 지원합니다.

WEP/WPA/WPA2 개인용 Wi-Fi 네트워크

사전 공유 키(암호) 기반 인증을 사용합니다.

사전 공유 키는 메뉴 또는 CPS/RM을 사용하여 입력할 수 있습니다.

WPA/WPA2 기업용 Wi-Fi 네트워크

인증서 기반 인증을 사용합니다.

무전기에는 인증서가 미리 구성되어 있어야 합니다.

 **주의:**
WPA/WPA2 기업용 Wi-Fi 네트워크에 연결하려면 판매점 또는 시스템 관리자에게 문의하십시오.

대리점이나 시스템 관리자가 프로그래밍된 **Wi-Fi 켜기 또는 끄기** 버튼이 할당합니다. 무전기가 프로그래밍된 방식에 대해서는 대리점이나 시스템 관리자에게 문의하십시오.











프로그래밍된 **Wi-Fi 켜기 또는 끄기** 버튼에 대한 음성 안내는 사용자의 요구 사항에 따라 CPS를 통해 맞춤 설정할 수 있습니다. 자세한 내용은 대리점이나 시스템 관리자에게 문의하십시오.

 **주의:**
감독자 무선 시스템을 사용하여 Wi-Fi를 원격으로 켜거나 끌 수 있습니다(**감독 기능 무전기를 사용하여 Wi-Fi 켜기 또는 끄기** 참조). 자세한 내용은 대리점이나 시스템 관리자에게 문의하십시오.

Wi-Fi 켜기 또는 끄기

절차에 따라 Wi-Fi를 켜고 끕니다.

- 1 프로그래밍된 **Wi-Fi 켜기 또는 끄기** 버튼을 누릅니다. Wi-Fi 켜기 또는 Wi-Fi 끄기라는 음성 안내가 들립니다.
- 2 메뉴를 사용하여 이 기능에 액세스합니다.

- a  버튼을 눌러 메뉴에 액세스합니다. 버튼을 누릅니다.
- b  또는  를 눌러 WiFi 및 선택하려면  버튼을 누릅니다.로 이동합니다.
- c  또는  를 눌러 WiFi 켜기 및 선택하려면  버튼을 누릅니다.로 이동합니다.
- d  을 눌러 Wi-Fi를 켜거나 끕니다.
Wi-Fi가 켜지면 디스플레이에 가 활성화됨 옆에 표시됩니다.
Wi-Fi가 꺼지면 디스플레이에 가 활성화됨 옆에서 사라집니다.



지정된 무전기를 사용하여 원격으로 Wi-Fi 켜기 또는 끄기(개별 제어)



다음 절차에 따라 개별 제어(일대일)에서 원격으로 Wi-Fi를 켜고 끕니다.







주의:

특정 CPS 설정이 있는 무전기만 이 기능을 지원합니다. 자세한 내용은 대리점이나 시스템 관리자에게 문의하십시오.

- 1 다음 중 하나를 수행합니다.
 - 프로그래밍 가능 버튼을 길게 누릅니다. 키패드를 사용하여 ID와 선택하려면  버튼을 누릅니다.을 입력합니다. 단계 3로 진행합니다.
 -  버튼을 눌러 메뉴에 액세스합니다. 버튼을 누릅니다.

- 2  또는  버튼을 눌러 연락처 및 선택하려면  버튼을 누릅니다.로 이동합니다.

- 3  또는  버튼을 눌러 WiFi 제어로 이동한 다음  버튼을 눌러 선택합니다.

- 4  또는  버튼을 눌러 켜기 또는 끄기를 선택합니다.

5  버튼을 눌러 선택합니다.

성공한 경우 디스플레이에 선택 미니 알림이 표시됩니다.

실패한 경우 디스플레이에 해제 미니 알림이 표시됩니다.

지정된 무전기를 사용하여 원격으로 Wi-Fi 켜기 또는 끄기(그룹 제어)



절차에 따라 그룹 제어(일대다)에서 원격으로 Wi-Fi를 켜고 끕니다.







주의:



특정 CPS 설정이 있는 무전기만 이 기능을 지원합니다. 자세한 내용은 대리점이나 시스템 관리자에게 문의하십시오.

1  버튼을 눌러 메뉴에 액세스합니다. 버튼을 누릅니다.

2  또는  버튼을 눌러 연락처 및 선택하려면  버튼을 누릅니다.로 이동합니다.

3  또는  버튼을 눌러 원하는 가입자 별칭 또는 ID를 선택합니다.

4  또는  버튼을 눌러 WiFi 제어로 이동한 다음  버튼을 눌러 선택합니다.

5  또는  버튼을 눌러 켜기 또는 끄기를 선택합니다.

6  버튼을 눌러 선택합니다.

성공한 경우 디스플레이에 전송 성공이 표시됩니다.

실패한 경우 디스플레이에 해제 미니 알림이 표시됩니다.

네트워크 액세스 포인트에 연결



Wi-Fi를 켜면 무전기가 네트워크 액세스 포인트를 스캔하여 연결합니다.



**주의:**



메뉴를 통해서도 네트워크 액세스 포인트에 연결할 수 있습니다.

WPA 기업용 Wi-Fi 네트워크 액세스 포인트는 사전 구성되어 있습니다. 무전기가 프로그래밍된 방식에 대해서는 대리점이나 시스템 관리자에게 문의하십시오.

1  버튼을 눌러 메뉴에 액세스합니다. 버튼을 누릅니다.



2  또는  를 눌러 WiFi 및 선택하려면  버튼을 누릅니다.로 이동합니다.

3  또는  을 눌러 네트워크 및 선택하려면  버튼을 누릅니다.로 이동합니다.

4  또는  을 눌러 네트워크 액세스 포인트 및 선택하려면  버튼을 누릅니다.로 이동합니다.

**주의:**

WPA 기업용 Wi-Fi의 경우 네트워크 액세스 포인트가 사전 구성되어 있지 않으면 연결 옵션을 사용할 수 없습니다.

5  또는  을 눌러 연결 및 선택하려면  버튼을 누릅니다.로 이동합니다.

6 WPA 개인용 Wi-Fi의 경우 암호를 입력하고  버튼을 누릅니다.

7 WPA 기업용 Wi-Fi의 경우 RM을 사용하여 암호를 구성합니다.

사전 구성된 암호가 맞으면 선택한 네트워크 액세스 포인트에 무전기가 자동으로 연결됩니다.

사전 구성된 암호가 틀리면 디스플레이에 인증 실패가 표시되고 자동으로 이전 메뉴로 돌아갑니다.

연결에 성공하면 무전기에 알림이 표시되며 네트워크 액세스 포인트가 프로필 목록에 저장됩니다.

연결에 실패하면 무전기 디스플레이에 실패 알림이 잠깐 동안 표시되고 자동으로 이전 메뉴로 돌아갑니다.

Wi-Fi 연결 상태 확인

다음 절차에 따라 Wi-Fi 연결 상태를 확인합니다.

음성 안내를 통해 연결 상태에 대한 프로그래밍된 **Wi-Fi 상태 쿼리** 버튼을 누릅니다. Wi-Fi 꺼짐, Wi-Fi가 켜졌지만 연결 없음 또는 Wi-Fi가 켜지고 연결됨이라는 음성 안내가 들립니다.

- Wi-Fi가 꺼지면 디스플레이에 WiFi 끄기가 표시됩니다.
- 무전기가 네트워크에 연결되면 디스플레이에 WiFi 켜기, 연결됨이 표시됩니다.
- Wi-Fi가 켜졌지만 무전기가 네트워크에 연결되지 않은 경우 WiFi 켜기, 연결 끊어짐이 표시됩니다.

Wi-Fi 상태 쿼리 결과에 대한 음성 안내는 사용자의 요구 사항에 따라 CPS를 통해 맞춤 설정할 수 있습니다. 자세한 내용은 대리점이나 시스템 관리자에게 문의하십시오.













주의:

프로그래밍된 **Wi-Fi 상태 쿼리** 버튼은 대리점이나 시스템 관리자에 의해 지정됩니다. 무전기가 프로그래밍된 방식에 대해서는 대리점이나 시스템 관리자에게 문의하십시오.

네트워크 목록 새로 고침

다음 절차에 따라 네트워크 목록을 새로 고칩니다.

- 메뉴를 통해 네트워크 목록을 새로 고치려면 다음 작업을 수행합니다.
 - a.  버튼을 눌러 메뉴에 액세스합니다. 버튼을 누릅니다.
 - b.  또는  를 눌러 WiFi 및 선택하려면  버튼을 누릅니다.로 이동합니다.
 - c.  또는  을 눌러 네트워크 및 선택하려면  버튼을 누릅니다.로 이동합니다.
네트워크 메뉴를 입력하면 무전기에서 자동으로 네트워크 목록을 새로 고칩니다.
- 네트워크 메뉴에 이미 있는 경우, 다음 작업을 수행하여 네트워크 목록을 새로 고칠 수 있습니다.

 또는  버튼을 눌러 새로 고침으로 이동하고 선택하려면  버튼을 누릅니다..

무전기에서 새로 고침한 뒤 최신 네트워크 목록을 표시합니다.

네트워크 추가









주의:



이 작업은 WPA 기업용 Wi-Fi 네트워크에는 적용되지 않습니다.

기본 설정 네트워크가 사용 가능한 네트워크 목록에 없는 경우 다음 작업을 수행하여 네트워크를 추가할 수 있습니다.



1  버튼을 눌러 메뉴에 액세스합니다.를 누릅니다.

2  또는  를 눌러 WiFi 및 선택하려면  버튼을 누릅니다.로 이동합니다.

3  또는  을 눌러 네트워크 및 선택하려면  버튼을 누릅니다.로 이동합니다.

4  또는  버튼을 눌러 네트워크 추가로 이동하고 선택하려면  버튼을 누릅니다..

5 SSID(Service Set Identifier)를 입력하고  을 누릅니다.



6  또는  버튼을 눌러 열기로 이동하고 선택하려면  버튼을 누릅니다..



7 암호를 입력하고  을 누릅니다.
무전기에 선택 미니 알람이 표시되어 네트워크가 성공적으로 저장되었음을 나타냅니다.



네트워크 액세스 포인트의 세부 항목 보기



네트워크 액세스 포인트의 세부 정보를 볼 수 있습니다.

1  버튼을 눌러 메뉴에 액세스합니다.를 누릅니다.

2  또는  를 눌러 WiFi 및 선택하려면  버튼을 누릅니다.로 이동합니다.

3  또는  을 눌러 네트워크 및 선택하려면  버튼을 누릅니다.로 이동합니다.

4  또는  을 눌러 네트워크 액세스 포인트 및 선택하려면  버튼을 누릅니다.로 이동합니다.

5  또는  버튼을 눌러 세부 항목 보기로 이동하고 선택하려면  버튼을 누릅니다..



주의:

WPA 개인용 Wi-Fi 및 WPA 기업용 Wi-Fi는 네트워크 액세스 포인트에 대한 서로 다른 세부 정보를 표시합니다.

WPA 개인용 Wi-Fi

연결된 네트워크 액세스 포인트의 경우 무전기에 SSID(Service Set Identifier), 보안 모드, MAC(media Access Control) 주소 및 IP(Internet Protocol) 주소가 표시됩니다.

연결되지 않은 네트워크 액세스 포인트의 경우 무전기에 SSID 및 보안 모드가 표시됩니다.

WPA 기업용 Wi-Fi

연결된 네트워크 액세스 포인트의 경우 무전기에 SSID, 보안 모드, ID, EAP(Extended Authentication Protocol) 방식, 2단계 인증, 인증서 이름, MAC 주소, IP 주소, 게이트웨이, DNS1 및 DNS2가 표시됩니다.

연결되지 않은 네트워크 액세스 포인트의 경우 무전기에 SSID, 보안 모드, ID, EAP 방식, 2단계 인증 및 인증서 이름이 표시됩니다.

네트워크 액세스 포인트 제거









주의:



이 작업은 기업 Wi-Fi 네트워크에는 적용되지 않습니다.



프로파일 목록에서 네트워크 액세스 포인트를 제거하려면 다음 작업을 수행합니다.



1  버튼을 눌러 메뉴에 액세스합니다. 버튼을 누릅니다.

2  또는  를 눌러 WiFi 및 선택하려면  버튼을 누릅니다.로 이동합니다.

3  또는  을 눌러 네트워크 및 선택하려면  버튼을 누릅니다.로 이동합니다.

4  또는  버튼을 눌러 선택한 네트워크 액세스 지점으로 이동하고 선택하려면  버튼을 누릅니다..

5  또는  버튼을 눌러 제거로 이동하고 선택하려면  버튼을 누릅니다..

6  또는  버튼을 눌러 예로 이동하고 선택하려면  버튼을 누릅니다..
무전기에 선택 미니 알림이 표시되어 선택한 네트워크 액세스 포인트가 성공적으로 제거되었음을 나타냅니다.

동적 그룹 번호 할당(DGNA)

동적 그룹 번호 할당(DGNA)은 콘솔이 무전기에서 새 통화 그룹을 무선으로 할당하거나 제거할 수 있도록 하는 기능입니다.

콘솔이 DGNA를 무전기에 할당하면 무전기는 DGNA 모드가 됩니다.

- 신호음이 울립니다.
- 홈 화면으로 돌아가기 전에 디스플레이에 <DGNA 통화 그룹 별칭> 할당됨이 잠시 표시됩니다.
- 상태 표시줄에 DGNA 아이콘이 나타납니다.
- 홈 화면에 DGNA 통화 그룹 별칭이 표시됩니다.

콘솔이 DGNA를 무전기에서 제거하면 무전기는 이전 통화 그룹으로 돌아갑니다.

- 신호음이 울립니다.
- 홈 화면으로 돌아가기 전에 디스플레이에 <DGNA 통화 그룹 별칭> 제거됨이 잠시 표시됩니다.
- 상태 표시줄에서 DGNA 아이콘이 사라집니다.
- 홈 화면에 이전 통화 그룹 별칭이 표시됩니다.

무전기가 어떻게 프로그래밍되었는지에 따라 원본 스캔 목록 채널과 DGNA 외 통화 그룹을 보고 편집하고 들을 수 있습니다.

무전기가 DGNA 모드일 때 PTT 버튼을 누르면 현재 DGNA 그룹과만 통신할 수 있습니다. 이전 DGNA 외 통화 그룹과 통신하려면 **원터치 액세스** 버튼을 프로그래밍하십시오. **비-DGNA 호출 페이지의 186**을 참조하십시오.



주의:

무전기가 프로그래밍된 방식에 대해서는 대리점이나 시스템 관리자에게 문의하십시오.

DGNA 호출

무전기가 DGNA 모드일 때 **PTT** 버튼을 눌러 호출합니다.

- DGNA 신호음이 울립니다.
- 디스플레이에 DGNA 아이콘과 DGNA 통화 그룹 별칭이 표시됩니다.



주의:

무전기가 DGNA 모드가 아닌 상태에서 **원터치 액세스** 버튼을 누르면 무전기에서 오류를 나타내는 신호음이 울립니다. 디스플레이가 변경되지 않습니다.

비-DGNA 호출

- 1 프로그래밍된 **원터치 액세스** 버튼을 누릅니다.
 - 성공음이 울립니다.
 - 음성 안내로 원터치 교체 호출이 울립니다.
 - 디스플레이에 <통화 그룹 별칭> 및 PTT를 누르십시오 가 잠시 표시됩니다.



주의:

무전기가 DGNA 모드가 아닌 상태에서 **원터치 액세스** 버튼을 누르면 무전기에서 오류를 나타내는 실패음이 울립니다. 디스플레이가 변경되지 않습니다.

- 2 실패음이 울리기 전에 **PTT** 버튼을 누르면 무전기가 홈 화면으로 돌아갑니다.



주의:

무전기가 홈 화면에 있는 경우 PTT 버튼을 누르면 DGNA 통화 그룹을 호출합니다.

DGNA 호출 수신 및 응답

DGNA 호출 수신 시:

- DGNA 신호음이 울립니다.
- 디스플레이에 DGNA 아이콘, DGNA 통화 그룹 별칭, 무전기 별칭이 표시됩니다.
- 무전기 음소거가 해제되고 호출 수신 시 스피커를 통해 소리가 납니다.

1 PTT 버튼을 눌러 호출에 응답합니다.

2 상대방의 말을 들으려면 **PTT** 버튼을 놓습니다.

공공설비

이 장에서는 무전기에서 사용할 수 있는 유틸리티 기능의 작동에 대해 설명합니다.

전력 레벨

전력 레벨을 각 채널에 대해 높음 또는 낮음으로 사용자 정의할 수 있습니다.

고

높음을 사용하면 원거리에 있는 무전기와 통신할 수 있습니다.

저

낮음을 사용하면 근거리에 있는 무전기와 통신할 수 있습니다.



주의:

이 기능은 동일한 주파수에 있는 **Citizens** 대역 채널에는 적용되지 않습니다.



전력 레벨 설정

다음 절차에 따라 무전기에서 전력 레벨을 설정합니다.



1 다음 중 하나를 수행합니다.



- 프로그래밍된 **전력 레벨** 버튼을 누릅니다. 아래 단계를 건너뛸 수 있습니다.
-  버튼을 눌러 메뉴로 이동합니다.

2

 또는  버튼을 눌러 유틸리티로 이동합니다.  버튼을 눌러 선택합니다.



3



 또는  버튼을 눌러 무전기 설정으로 이동합니다.  버튼을 눌러 선택합니다.

4  또는  버튼을 눌러 전력으로 이동합니다.

 버튼을 눌러 선택합니다.

5 다음 중 하나를 수행합니다.

-  또는  버튼을 눌러 높음으로 이동합니다.  버튼을 눌러 선택합니다.
✓가 디스플레이의 높음 옆에 표시됩니다.

-  또는  버튼을 눌러 낮음으로 이동합니다.  버튼을 눌러 선택합니다.
✓가 디스플레이의 낮음 옆에 표시됩니다.

6 홈 화면으로 돌아가려면  버튼을 길게 누릅니다.



무전기 신호음/경보 켜기 또는 끄기



필요한 경우 들어오는 비상 경보음을 제외한 모든 무전기 신호음과 경보를 활성화하거나 비활성화할 수 있습니다. 다음 절차에 따라 무전기에서 신호음 및 경보를 켜거나 끕니다.



1 다음 중 하나를 수행합니다.



- 프로그래밍된 **신호음/경보** 버튼을 누릅니다. 다음 단계를 건너뛴니다.

-  버튼을 눌러 메뉴로 이동합니다.

2  또는  버튼을 눌러 유틸리티로 이동합니다.  버튼을 눌러 선택합니다.

3  또는  버튼을 눌러 무전기 설정으로 이동합니다.  버튼을 눌러 선택합니다.

4  또는  버튼을 눌러 톤/경보로 이동합니다.  버튼을 눌러 선택합니다.

5  또는  버튼을 눌러 전체 톤으로 이동합니다.  버튼을 눌러 선택합니다.













6  버튼을 눌러 전체 톤 및 경보를 활성화하거나 비활성화합니다. 디스플레이에 다음 결과 중 하나가 표시됩니다.

- 활성화되면 ✓아이콘이 활성화 옆에 표시됩니다.

- 비활성화되면 ✓ 아이콘이 활성화 옆에서 사라집니다.

키패드 톤 켜기 또는 끄기







다음 절차에 따라 무전기에서 키패드 톤을 켜거나 끕니다.

- 1  버튼을 눌러 메뉴로 이동합니다.
- 2  또는  버튼을 눌러 유틸리티로 이동합니다.  버튼을 눌러 선택합니다.
- 3  또는  버튼을 눌러 무전기 설정으로 이동합니다.  버튼을 눌러 선택합니다.
- 4  또는  버튼을 눌러 톤/경보로 이동합니다.  버튼을 눌러 선택합니다.
- 5  또는  버튼을 눌러 키패드 톤으로 이동합니다.  버튼을 눌러 선택합니다.

- 6  을 눌러 키패드 톤을 활성화하거나 비활성화합니다. 디스플레이에 다음 결과 중 하나가 표시됩니다.
 - 활성화되면 ✓ 아이콘이 활성화 옆에 표시됩니다.
 - 비활성화되면 ✓ 아이콘이 활성화 옆에서 사라집니다.

신호음/경보 볼륨 오프셋 레벨 설정

이 기능은 신호음 또는 경보의 볼륨을 해당 음성의 볼륨보다 크거나 작게 조절합니다. 다음 절차에 따라 무전기에서 신호음 및 경보의 볼륨 오프셋 레벨을 설정합니다.

- 1  버튼을 눌러 메뉴로 이동합니다.
- 2  또는  버튼을 눌러 유틸리티로 이동합니다.  버튼을 눌러 선택합니다.
- 3  또는  버튼을 눌러 무전기 설정으로 이동합니다.  버튼을 눌러 선택합니다.

4 ▲ 또는 ▼ 버튼을 눌러 톤/경보로 이동합니다.

 버튼을 눌러 선택합니다.



5 ▲ 또는 ▼ 을 눌러 볼륨 오프셋으로 이동합니

다.  버튼을 눌러 선택합니다.

6 ▲ 또는 ▼ 버튼을 눌러 원하는 볼륨 오프셋 레 벨로 이동합니다.

각각의 해당 볼륨 오프셋 레벨과 함께 피드백 신호음 이 울립니다.

7 다음 중 하나를 수행합니다.

-  버튼을 눌러 선택합니다. 원하는 볼륨 오프 셋 수준이 저장되었습니다.
 - 종료하려면  을 누릅니다. 변경 내용은 무시됩 니다.
-

통화 허용 신호음 켜기 또는 끄기

다음 절차에 따라 무전기에서 통화 허용 신호음을 켜거나 끕니다.

1  버튼을 눌러 메뉴로 이동합니다.

2 ▲ 또는 ▼ 버튼을 눌러 유틸리티로 이동합니
다.  버튼을 눌러 선택합니다.



3 ▲ 또는 ▼ 버튼을 눌러 무전기 설정으로 이동
합니다.  버튼을 눌러 선택합니다.

4 ▲ 또는 ▼ 버튼을 눌러 톤/경보로 이동합니다.
 버튼을 눌러 선택합니다.

5 ▲ 또는 ▼ 버튼을 눌러 통화 허용으로 이동합
니다.  버튼을 눌러 선택합니다.

6  버튼을 눌러 통화 허용 경보음을 활성화하거나 비활성화합니다.



디스플레이에 다음 결과 중 하나가 표시됩니다.



- 활성화되면  아이콘이 활성화 옆에 표시됩니다.
- 비활성화되면  아이콘이 활성화 옆에서 사라집니다.



전원 켜짐 신호음 켜기 또는 끄기

다음 절차에 따라 무전기에서 전원 켜짐 신호음을 켜거나 끕니다.



1  버튼을 눌러 메뉴로 이동합니다.

2  또는  버튼을 눌러 유틸리티로 이동합니다.  버튼을 눌러 선택합니다.



3  또는  버튼을 눌러 무전기 설정으로 이동합니다.  버튼을 눌러 선택합니다.

4  또는  버튼을 눌러 톤/경보로 이동합니다.

 버튼을 눌러 선택합니다.

5  또는  버튼을 눌러 출력 증강으로 이동합니다.  버튼을 눌러 선택합니다.



6  버튼을 눌러 출력 증강 톤을 활성화하거나 비활성화합니다. 디스플레이에 다음 결과 중 하나가 표시됩니다.

- 활성화되면  아이콘이 활성화 옆에 표시됩니다.
- 비활성화되면  아이콘이 활성화 옆에서 사라집니다.



문자 메시지 경보음 설정

연락처 목록의 각 항목에 대한 문자 메시지 경보음을 일시적 또는 반복으로 사용자 지정할 수 있습니다. 다음 절차에 따라 무전기에서 문자 메시지 경보음을 설정합니다.



1  버튼을 눌러 메뉴로 이동합니다.

2  또는  버튼을 눌러 연락처로 이동합니다.

 버튼을 눌러 선택합니다.



3  또는  버튼을 눌러 원하는 별칭 또는 ID로



이동합니다.  버튼을 눌러 선택합니다.

4  또는  버튼을 눌러 메시지 경보로 이동합

니다.  버튼을 눌러 선택합니다.

5 다음 중 하나를 수행합니다.

-  또는  버튼을 눌러 일시적으로 이동합니다.  버튼을 눌러 선택합니다.
✓가 디스플레이의 일시적 옆에 표시됩니다.

-  또는  버튼을 눌러 반복적으로 이동합니다.  버튼을 눌러 선택합니다.
✓가 디스플레이의 반복적 옆에 표시됩니다.



디스플레이 모드 변경

필요에 따라 무전기의 디스플레이 모드를 주간이나 야간으로 변경할 수 있습니다. 이 기능은 디스플레이의 색상표에 영향을 줍니다. 다음 절차에 따라 무전기의 디스플레이 모드를 변경합니다.



1 다음 중 하나를 수행합니다.

- 프로그래밍된 **디스플레이 모드** 버튼을 누릅니다. 다음 단계를 건너뛵니다.

-  버튼을 눌러 메뉴로 이동합니다.

2  또는  버튼을 눌러 유틸리티로 이동합니

다.  버튼을 눌러 선택합니다.

3  또는  버튼을 눌러 무전기 설정으로 이동

합니다.  버튼을 눌러 선택합니다.

4 ▲ 또는 ▼ 버튼을 눌러 디스플레이로 이동합니다. [OK] 버튼을 눌러 선택합니다.
디스플레이에 주간 모드와 야간 모드가 표시됩니다.

5 ▲ 또는 ▼ 버튼을 눌러 원하는 설정으로 이동합니다. [OK] 버튼을 눌러 선택합니다.
디스플레이에서 선택된 설정 옆에 ✓가 표시됩니다.

디스플레이 선명도 조절

다음 절차에 따라 무전기의 디스플레이 선명도를 조절합니다. 밝기 자동이 활성화된 경우에는 디스플레이 밝기를 조절할 수 없습니다.

- 다음 중 하나를 수행합니다.
 - 프로그래밍된 **선명도** 버튼을 누릅니다. 다음 단계를 건너뛸니다.
 - [OK] 버튼을 눌러 메뉴로 이동합니다.
-

2 ▲ 또는 ▼ 버튼을 눌러 유틸리티로 이동합니다. [OK] 버튼을 눌러 선택합니다.

3 ▲ 또는 ▼ 버튼을 눌러 무전기 설정으로 이동합니다. [OK] 버튼을 눌러 선택합니다.

4 ▲ 또는 ▼ 버튼을 눌러 선명도로 이동합니다. [OK] 버튼을 눌러 선택합니다.
디스플레이에 선명도 표시줄이 나타납니다.



5 ▲ 또는 ▼ 버튼을 눌러 디스플레이 선명도를 낮추거나 높입니다. [OK] 버튼을 눌러 선택합니다.
설정 값은 1~8 사이입니다.



혼/라이트 켜기 또는 끄기



무전기는 혼 및 라이트 기능을 통해 사용자에게 수신 호출을 알릴 수 있습니다. 활성화된 경우 호출이 들어오면 혼이 울리고 차량의 라이트가 켜집니다. 이 기능은 대리점에서 무전



기 후면 액세서리 커넥터를 통해 설치해야 합니다. 다음 절차에 따라 무전기에서 모든 혼 및 라이트를 켜거나 끕니다.

- 1 다음 중 하나를 수행합니다.
 - 프로그래밍된 **혼/라이트** 버튼을 누릅니다. 아래 단계를 건너뛰니다.
 -  버튼을 눌러 메뉴로 이동합니다.

- 2  또는  버튼을 눌러 유틸리티로 이동합니다.  버튼을 눌러 선택합니다.

- 3  또는  버튼을 눌러 무전기 설정으로 이동합니다.  버튼을 눌러 선택합니다.

- 4  또는  버튼을 눌러 혼/라이트로 이동합니다.  버튼을 눌러 선택합니다.

- 5  버튼을 눌러 혼/라이트를 활성화하거나 비활성화합니다. 디스플레이에 다음 결과 중 하나가 표시됩니다.
 - 활성화되면  아이콘이 활성화 옆에 표시됩니다.



- 비활성화되면  아이콘이 활성화 옆에서 사라집니다.

LED 표시등 켜기 또는 끄기

다음 절차에 따라 무전기에서 LED 표시등을 켜거나 끕니다.



- 1  버튼을 눌러 메뉴로 이동합니다.

- 2  또는  버튼을 눌러 유틸리티로 이동합니다.  버튼을 눌러 선택합니다.

- 3  또는  버튼을 눌러 무전기 설정으로 이동합니다.  버튼을 눌러 선택합니다.

- 4  또는  버튼을 눌러 LED 표시등으로 이동합니다.  버튼을 눌러 선택합니다.



- 5  버튼을 눌러 LED 표시를 활성화하거나 비활성화합니다. 디스플레이에 다음 결과 중 하나가 표시됩니다.



- 활성화되면  아이콘이 활성화 옆에 표시됩니다.
- 비활성화되면  아이콘이 활성화 옆에서 사라집니다.



공용 주소 시스템 켜기 또는 끄기



다음 절차에 따라 무전기의 내부 공용 주소(PA) 시스템을 활성화하거나 비활성화합니다.

- 1 다음 중 하나를 수행합니다.
 - 프로그래밍된 **공용 주소** 버튼을 누릅니다. 다음 단계를 건너뜁니다.
 -  버튼을 눌러 메뉴로 이동합니다.

- 2  또는  버튼을 눌러 유틸리티로 이동합니다.  버튼을 눌러 선택합니다.

- 3  또는  버튼을 눌러 무전기 설정으로 이동합니다.  버튼을 눌러 선택합니다.



- 4  또는  버튼을 눌러 공용 주소로 이동합니다.  버튼을 눌러 선택합니다.



- 5  버튼을 눌러 공용 주소를 활성화하거나 비활성화합니다.
 - 활성화되면  아이콘이 활성화 옆에 표시됩니다.
 - 비활성화되면  아이콘이 활성화 옆에서 사라집니다.



외부 공용 주소 시스템 켜기 또는 끄기



다음 절차에 따라 무전기의 외부 공용 주소(PA) 시스템을 활성화하거나 비활성화합니다.

- 1 다음 중 하나를 수행합니다.
 - 프로그래밍된 **외부 공용 주소** 버튼을 누릅니다. 다음 단계를 건너뜁니다.
 -  버튼을 눌러 메뉴로 이동합니다.

- 2  또는  버튼을 눌러 유틸리티로 이동합니다.  버튼을 눌러 선택합니다.

- 3  또는  버튼을 눌러 무전기 설정으로 이동합니다.  버튼을 눌러 선택합니다.



- 4  또는  버튼을 눌러 외부 공용 주소로 이동합니다.  버튼을 눌러 선택합니다.



- 5  버튼을 눌러 외부 공용 주소를 활성화하거나 비활성화합니다.
 - 활성화되면  아이콘이 활성화 옆에 표시됩니다.
 - 비활성화되면  아이콘이 활성화 옆에서 사라집니다.



홈 화면 켜기 또는 끄기



다음 절차에 따라 홈 화면을 활성화하거나 비활성화할 수 있습니다.

- 1  버튼을 눌러 메뉴로 이동합니다.

- 2  또는  버튼을 눌러 유틸리티로 이동합니다.  버튼을 눌러 선택합니다.

- 3  또는  버튼을 눌러 무전기 설정으로 이동합니다.  버튼을 눌러 선택합니다.

- 4  또는  을 눌러 표시로 이동합니다.  버튼을 눌러 선택합니다.











- 5  또는  을 눌러 초기 화면으로 이동합니다.  버튼을 눌러 선택합니다.





- 6  버튼을 눌러 홈 화면을 활성화하거나 비활성화합니다.
디스플레이에 다음 결과 중 하나가 표시됩니다.
 - 활성화되면  아이콘이 활성화 옆에 표시됩니다.

- 비활성화되면  아이콘이 활성화 옆에서 사라집니다.

언어 설정











다음 절차에 따라 무전기에서 언어를 설정합니다.

- 1  버튼을 눌러 메뉴로 이동합니다.
- 2  또는  버튼을 눌러 유틸리티로 이동합니다.  버튼을 눌러 선택합니다.
- 3  또는  버튼을 눌러 무전기 설정으로 이동합니다.  버튼을 눌러 선택합니다.
- 4  또는  을 눌러 언어로 이동합니다.  버튼을 눌러 선택합니다.

- 5  또는  버튼을 눌러 원하는 언어로 이동합니다.  버튼을 눌러 선택합니다. 디스플레이에서 선택한 언어 옆에 가 표시됩니다.

케이블 타입 식별

무전기에 사용되는 케이블 유형을 선택하려면 다음 단계를 수행하십시오.

- 1  버튼을 눌러 메뉴로 이동합니다.
- 2  또는  버튼을 눌러 유틸리티로 이동합니다.  버튼을 눌러 선택합니다.
- 3  또는  버튼을 눌러 무전기 설정으로 이동합니다.  버튼을 눌러 선택합니다.
- 4  또는  버튼을 눌러 케이블 타입으로 이동합니다.  버튼을 눌러 선택합니다.

5 현재 케이블 타입은 ✓로 표시됩니다.

음성 안내 켜기 또는 끄기

이 기능을 사용하면 무전기에서 사용자가 방금 지정한 현재 존 또는 채널이나 사용자가 방금 누른 프로그래밍 가능 버튼을 청각적으로 나타낼 수 있습니다.

이 기능은 사용자가 디스플레이에 표시된 내용을 읽는 데 어려움을 겪고 있을 때 특히 유용합니다.

이 오디오 표시 기능은 고객 요구에 따라 사용자 정의할 수 있습니다. 다음 절차에 따라 무전기에서 음성 안내를 켜거나 끕니다.

옵션 보드 켜기 또는 끄기

각 채널 내의 옵션 보드 기능을 프로그래밍 가능 버튼에 지정할 수 있습니다. 하나의 채널에서 최대 6개 옵션 보드 기능을 지원할 수 있습니다. 다음 절차에 따라 무전기에서 옵션 보드를 켜거나 끕니다.

프로그래밍된 **옵션 보드** 버튼을 누릅니다.

TTS

TTS 기능은 대리점이나 시스템 관리자만 활성화할 수 있습니다. TTS 기능이 활성화되면 음성 안내 기능이 자동으로 비활성화됩니다. 음성 안내 기능이 활성화되면 TTS 기능이 자동으로 비활성화됩니다.

이 기능은 무전기에서 다음 기능을 소리로 나타냅니다.

- 현재 채널
- 현재 존
- 프로그래밍된 버튼 기능 켜기/끄기
- 수신된 문자 메시지의 내용
- 수신된 작업 티켓의 내용

이 오디오 표시 기능은 고객 요구에 맞게 사용자 정의할 수 있습니다. 이 기능은 사용자가 디스플레이에 표시된 내용을 읽기 어려운 상황일 때 특히 유용합니다.



TTS 설정



다음 절차에 따라 TTS 기능을 설정합니다.



1





버튼을 눌러 메뉴로 이동합니다.

2  또는  버튼을 눌러 유틸리티로 이동합니다.  버튼을 눌러 선택합니다.

3  또는  버튼을 눌러 무전기 설정으로 이동합니다.  버튼을 눌러 선택합니다.

4  또는  버튼을 눌러 음성 안내로 이동합니다.  버튼을 눌러 선택합니다.

5  또는  을 눌러 다음 기능 중 하나로 이동합니다.  버튼을 눌러 선택합니다.
사용할 수 있는 기능은 다음과 같습니다.



- 모두
- 메시지
- 작업 티켓
- 채널
- 구역



- 프로그램 버튼
- ✓ 선택한 설정 옆에 가 표시됩니다.



메뉴 타이머 설정



무전기가 홈 화면으로 자동 전환되기 전에 메뉴에 머무를 시간을 설정할 수 있습니다. 다음 절차에 따라 메뉴 타이머를 설정합니다.



1  버튼을 눌러 메뉴로 이동합니다.



2  또는  버튼을 눌러 유틸리티로 이동합니다.  버튼을 눌러 선택합니다.



3  또는  버튼을 눌러 무전기 설정으로 이동합니다.  버튼을 눌러 선택합니다.

4  또는  버튼을 눌러 디스플레이로 이동합니다.  버튼을 눌러 선택합니다.

5  또는  버튼을 눌러 메뉴 타이머로 이동합니다.  버튼을 눌러 선택합니다.



6  또는  버튼을 눌러 원하는 설정으로 이동합니다.  버튼을 눌러 선택합니다.

3  또는  버튼을 눌러 무전기 설정으로 이동합니다.  버튼을 눌러 선택합니다.

4  또는  버튼을 눌러 마이크 AGC-D로 이동합니다.  버튼을 눌러 선택합니다.

5  을 눌러 디지털 마이크 AGC를 활성화하거나 비활성화합니다.

디스플레이에 다음 결과 중 하나가 표시됩니다.



- 활성화되면  아이콘이 활성화 옆에 표시됩니다.
- 비활성화되면  아이콘이 활성화 옆에서 사라집니다.

디지털 마이크 AGC 켜기 또는 끄기

디지털 마이크 AGC(자동 게인 제어)는 디지털 시스템에서 전송하는 동안 자동으로 무전기의 마이크 게인을 제어합니다.

이 기능을 사용하면 일정한 수준의 음량을 제공하기 위해 큰 소리가 억제되거나 작은 소리가 미리 설정된 값만큼 커집니다. 다음 절차에 따라 무전기에서 디지털 마이크 AGC를 켜거나 끕니다.

1  버튼을 눌러 메뉴로 이동합니다.

2  또는  버튼을 눌러 유틸리티로 이동합니다.  버튼을 눌러 선택합니다.

지능형 오디오 켜기 또는 끄기

정상성 잡음원과 비정상성 잡음원 모두를 포함하여 환경의 현재 주변 소음을 억제하기 위해 무전기의 오디오 볼륨이 자동으로 조절됩니다. 이 기능은 수신 전용 기능이며 전송음에는 영향을 주지 않습니다. 다음 절차에 따라 무전기에서 지능형 오디오를 켜거나 끕니다.

**주의:**

이 기능은 Bluetooth 세션 중에는 적용되지 않습니다.

- 다음 중 하나를 수행합니다.
 - 프로그래밍된 **지능형 오디오** 버튼을 누릅니다. 아래 단계를 건너뛰니다.
 - 버튼을 눌러 메뉴로 이동합니다.

- 또는 버튼을 눌러 유틸리티로 이동합니다. 버튼을 눌러 선택합니다.

- 또는 버튼을 눌러 무전기 설정으로 이동합니다. 버튼을 눌러 선택합니다.

- 또는 버튼을 눌러 지능형 오디오로 이동합니다. 버튼을 눌러 선택합니다.



- 다음 중 하나를 수행합니다.



- 또는 버튼을 눌러 켜기로 이동합니다. 버튼을 눌러 선택합니다. ✓가 디스플레이의 켜기 옆에 표시됩니다.
- 또는 버튼을 눌러 끄기로 이동합니다. 버튼을 눌러 선택합니다. ✓가 디스플레이의 끄기 옆에 표시됩니다.

음향 피드백 억제기 기능 켜기 또는 끄기



이 기능은 수신된 호출에서 발생하는 음향 피드백을 최소화합니다.

- 버튼을 눌러 메뉴에 액세스합니다. 을 누릅니다.
- 또는 을 눌러 유틸리티 및 선택하려면 버튼을 누릅니다. 로 이동합니다.

3  또는  을 눌러 무전기 설정으로 이동하고 선택하려면  버튼을 누릅니다..

4  또는  버튼을 눌러 HF 피드백 억제기 및 선택하려면  버튼을 누릅니다.로 이동합니다. 또한 또는 버튼을 사용하여 선택된 옵션을 변경할 수도 있습니다.

5 다음 중 하나를 수행합니다.



-  버튼을 눌러 음향 피드백 억제기를 활성화합니다. 디스플레이의 활성화됨 옆에 ✓가 표시됩니다.
-  버튼을 눌러 음향 피드백 억제기를 비활성화합니다. ✓아이콘이 활성화 옆에서 사라집니다.



트릴 강화 켜기 또는 끄기



치경음 트릴(굴리는 "R") 발음이 있는 단어가 많이 포함된 언어로 이야기할 경우 이 기능을 활성화할 수 있습니다. 다음 절차에 따라 무전기에서 트릴 강화를 켜거나 끕니다.

1 다음 중 하나를 수행합니다.



- 프로그래밍된 **트릴 강화** 버튼을 누릅니다. 아래 단계를 건너뛴니다.
-  버튼을 눌러 메뉴로 이동합니다.





2  또는  버튼을 눌러 유틸리티로 이동합니다.  버튼을 눌러 선택합니다.

3  또는  버튼을 눌러 무전기 설정으로 이동합니다.  버튼을 눌러 선택합니다.

4  또는  버튼을 눌러 트릴 강화로 이동합니다.  버튼을 눌러 선택합니다.

5 다음 중 하나를 수행합니다.

-  또는  버튼을 눌러 켜기로 이동합니다.  버튼을 눌러 선택합니다. ✓가 디스플레이의 켜기 옆에 표시됩니다.

-  또는  버튼을 눌러 **끄기**로 이동합니다.
 버튼을 눌러 선택합니다. 가 디스플레이의 **끄기** 옆에 표시됩니다.

오디오 환경

사용자 환경에 따라 무전기의 오디오 환경을 사용자 정의할 수 있습니다.

기본

기본 설정입니다.

크게













이 설정은 잡음 방지 장치를 활성화하고 주변 소음이 심한 환경에서 사용할 수 있도록 스피커 볼륨을 높입니다.

작업 그룹

이 설정은 무전기 그룹이 서로 근처에 있을 때 **AF** 억제기를 활성화하고 **AGC**를 비활성화하여 사용합니다.

오디오 환경 설정

다음 절차에 따라 무전기에서 환경에 적합한 오디오 환경을 설정합니다.

-  버튼을 눌러 메뉴로 이동합니다.
-  또는  버튼을 눌러 유틸리티로 이동합니다.  버튼을 눌러 선택합니다.
-  또는  버튼을 눌러 무전기 설정으로 이동합니다.  버튼을 눌러 선택합니다.
-  또는  버튼을 눌러 오디오 환경으로 이동합니다.  버튼을 눌러 선택합니다.
-  또는  버튼을 눌러 원하는 설정으로 이동합니다.  버튼을 눌러 선택합니다.
 설정은 다음과 같습니다.
 - 출하시 기본 설정은 기본값을 선택합니다.
 - 주변 소음이 심한 환경에서 스피커 볼륨을 높이면 크게를 선택합니다.

- 서로 인접한 무전기 그룹으로 사용할 때 음향 피드백을 줄이려면 작업 그룹을 선택합니다.
디스플레이에서 선택된 설정 옆에 ✓가 표시됩니다.

오디오 프로필

사용자 선호도에 따라 무전기의 오디오 프로필을 사용자 정의할 수 있습니다.

기본

기본 설정입니다.

레벨 1, 레벨 2 및 레벨 3

이 설정은 40대, 50대 및 60대 이상 성인에게 흔한 소음성 난청을 보완하기 위해 고안되었습니다.



고음 강조, 중음 강조 및 저음 강조



이 설정은 날카로운 소리, 비음이 높은 소리, 깊은 소리를 강조할 수 있도록 고안되었습니다.



오디오 프로필 설정



다음 절차에 따라 무전기에서 오디오 프로필을 설정합니다.

- 1  버튼을 눌러 메뉴로 이동합니다.

- 2  또는  버튼을 눌러 유틸리티로 이동합니다.  버튼을 눌러 선택합니다.

- 3  또는  버튼을 눌러 무전기 설정으로 이동합니다.  버튼을 눌러 선택합니다.

- 4  또는  버튼을 눌러 오디오 프로필로 이동합니다.  버튼을 눌러 선택합니다.

- 5  또는  버튼을 눌러 원하는 설정으로 이동합니다.  버튼을 눌러 선택합니다.
설정은 다음과 같습니다.

- 기본값을 선택하여 이전에 선택한 오디오 프로필을 비활성화하고 출하시 기본값으로 돌아갑니다.
- 40대 이상 성인에게 흔한 소음성 난청을 보완하기 위해 고안된 오디오 프로필로 레벨 1, 레벨 2 또는 레벨 3을 선택합니다.

- 날카로운 소리, 비음 또는 깊은 소리에 대한 기본 설정을 지정하는 오디오 프로필로 고음 강조, 중음 강조 또는 저음 강조를 선택합니다.

디스플레이에서 선택된 설정 옆에 ✓가 표시됩니다.

GNSS 켜기 또는 끄기



GNSS(위성항법시스템)는 무전기의 정확한 위치를 결정하는 위성 탐색 시스템입니다. GNSS에는 GPS(Global Positioning System) 및 BDS(BeiDou Navigation Satellite System)가 포함됩니다.









주의:

선택한 무전기 모델은 GPS 및 BDS를 제공할 수 있습니다. GNSS 위성항법 시스템은 CPS를 사용하여 구성됩니다. 무전기가 프로그래밍된 방식에 대해서는 대리점이나 시스템 관리자에게 문의하십시오.

- 1 다음 단계 중 하나를 수행하여 무전기에서 GNSS를 켜거나 끕니다.
 - 프로그래밍된 **GNSS** 버튼을 누릅니다.
 -  버튼을 눌러 메뉴로 이동합니다. 다음 단계로 진행합니다.

- 2  또는  버튼을 눌러 유틸리티로 이동합니다.  버튼을 눌러 선택합니다.

- 3  또는  버튼을 눌러 무전기 설정으로 이동합니다.  버튼을 눌러 선택합니다.

- 4  또는  을 눌러 GNSS로 이동합니다.  버튼을 눌러 선택합니다.

- 5  버튼을 눌러 GNSS를 활성화하거나 비활성화합니다.
활성화되면 ✓아이콘이 활성화 옆에 표시됩니다.
비활성화되면 ✓아이콘이 활성화 옆에서 사라집니다.

일반 무전기 정보

무전기에는 다양한 일반 매개변수에 대한 정보가 포함되어 있습니다.

무전기의 일반 정보는 다음과 같습니다.

- 무전기 별칭 및 ID.

- 펌웨어 및 코드플러그 버전.
- 소프트웨어 업데이트.
- GNSS 정보.
- 사이트 정보.



주의:

이전 화면으로 돌아가려면 버튼을 누릅니다.
홈 화면으로 돌아가려면 버튼을 길게 누릅니다. 무전기는 비활성 타이머가 만료되는 즉시 현재 화면을 종료합니다.

무전기 별칭 및 ID 확인

다음 절차에 따라 무전기에서 무전기 별칭 및 ID를 확인합니다.

- 1 다음 중 하나를 수행합니다.
 - 프로그래밍된 **무전기 별칭 및 ID** 버튼을 누릅니다. 다음 단계를 건너뛸니다. 선택음이 울립니다.
프로그래밍된 **무전기 별칭 및 ID** 버튼을 눌러 이전 화면으로 돌아갈 수 있습니다.

- 버튼을 눌러 메뉴로 이동합니다.

- 2 또는 버튼을 눌러 유틸리티로 이동합니다. 버튼을 눌러 선택합니다.

- 3 또는 버튼을 눌러 무전기 정보로 이동합니다. 버튼을 눌러 선택합니다.



- 4 또는 을 눌러 내 ID로 이동합니다. 버튼을 눌러 선택합니다.



첫 번째 텍스트 줄에 무전기 별칭이 표시됩니다. 두 번째 텍스트 줄에 무전기 ID가 표시됩니다.



펌웨어 및 코드플러그 버전 확인

다음 절차에 따라 무전기의 펌웨어 및 코드플러그 버전을 확인합니다.

- 1 버튼을 눌러 메뉴로 이동합니다.

2  또는  버튼을 눌러 유틸리티로 이동합니다.  버튼을 눌러 선택합니다.



3  또는  버튼을 눌러 무전기 정보로 이동합니다.  버튼을 눌러 선택합니다.



4  또는  버튼을 눌러 버전으로 이동합니다.  버튼을 눌러 선택합니다.
디스플레이에 현재 펌웨어 및 코드플러그 버전이 표시됩니다.



소프트웨어 업데이트 정보 확인

이 기능을 사용하면 최근에 OTAP 또는 Wi-Fi를 통해 수행된 소프트웨어 업데이트의 날짜와 시간이 표시됩니다. 다음 절차에 따라 무전기에서 소프트웨어 업데이트 정보를 확인합니다.

1  버튼을 눌러 메뉴로 이동합니다.

2  또는  버튼을 눌러 유틸리티로 이동합니다.  버튼을 눌러 선택합니다.

3  또는  버튼을 눌러 무전기 정보로 이동합니다.  버튼을 눌러 선택합니다.

4  또는  버튼을 눌러 소프트웨어 업데이트로 이동합니다.  버튼을 눌러 선택합니다.
디스플레이에 최신 소프트웨어 업데이트 날짜와 시간이 표시됩니다.

소프트웨어 업데이트 메뉴는 성공한 OTAP 또는 Wi-Fi 세션이 하나 이상 있을 때만 사용할 수 있습니다. 자세한 내용은 [OTAP\(무선 프로그래밍\) 페이지의 451](#) 부분을 참조하십시오.



GNSS 정보 확인



무전기에 다음과 같은 GNSS 정보를 표시합니다.



- 위도
- 경도



- 고도
- 방향
- 속도
- HDOP(Horizontal Dilution of Precision)
- 위성 수
- 버전

1  버튼을 눌러 메뉴로 이동합니다.

2  또는  버튼을 눌러 유틸리티로 이동합니다.  버튼을 눌러 선택합니다.

3  또는  버튼을 눌러 무전기 정보로 이동합니다.  버튼을 눌러 선택합니다.



4  또는  버튼을 눌러 GNSS 정보로 이동합니다.  버튼을 눌러 선택합니다.



5  또는  버튼을 눌러 원하는 항목으로 이동합니다.  버튼을 눌러 선택합니다. 디스플레이에 요청한 GNSS 정보가 표시됩니다.



사이트 정보 표시

다음 절차에 따라 무전기가 켜져 있는 현재 사이트의 이름을 표시합니다.

1  버튼을 눌러 메뉴로 이동합니다.

2  또는  버튼을 눌러 유틸리티로 이동합니다.  버튼을 눌러 선택합니다.

3  또는  버튼을 눌러 무전기 정보로 이동합니다.  버튼을 눌러 선택합니다.



4  또는  버튼을 눌러 사이트 정보로 이동합니다.  버튼을 눌러 선택합니다.



디스플레이에 현재 사이트 이름이 표시됩니다.



기업 Wi-Fi 인증서 세부 정보 보기

선택한 기업 Wi-Fi 인증서의 세부 정보를 볼 수 있습니다.

- 1  버튼을 눌러 메뉴로 이동합니다.

- 2  또는  버튼을 눌러 유틸리티로 이동합니다.  버튼을 눌러 선택합니다.

- 3  또는  버튼을 눌러 인증서 메뉴로 이동합니다.  버튼을 눌러 선택합니다.
✓가 준비된 인증서 옆에 나타납니다.

- 4  또는  버튼을 눌러 필요한 인증서로 이동합니다.  버튼을 눌러 선택합니다.

무전기에 인증서의 전체 세부 정보가 표시됩니다.



주의:

인증서가 준비되지 않은 경우, 디스플레이에는 상태만 표시됩니다.

Connect Plus 작동

Connect Plus는 DMR 기술에 기반을 둔 풀 트렁킹 솔루션입니다. Connect Plus는 채널 요청 및 할당을 위해 전용 제어 채널을 사용합니다. 이 시스템의 무전기 사용자가 사용할 수 있는 기능은 이 장에 나와 있습니다.

Connect Plus 모드의 추가 무전기 컨트롤

이 장에서는 프로그래밍 가능 버튼 및 할당 가능한 무전기 기능 같은 미리 프로그래밍된 수단을 통해 무전기 사용자에게 제공되는 추가 무전기 컨트롤을 설명합니다.

PTT(Push-To-Talk) 버튼

무전기 측면에 있는 **PTT** 버튼은 두 가지 기본 용도로 사용됩니다.

- 호출 중인 경우에는 **PTT** 버튼을 누르면 호출 중인 다른 무전기에 전송할 수 있습니다.

말하려면 **PTT** 버튼을 길게 누릅니다. 상대방의 말을 들으려면 **PTT** 버튼을 놓습니다.

PTT 버튼을 누르면 마이크가 활성화됩니다.

- 호출 중이 아닌 동안에는 **PTT** 버튼이 새 호출을 전송하는 데 사용됩니다(**무전기 호출 송신 페이지의 225** 참조).

통화 허가음이 활성화되어 있는 경우 대화하기 전에 짧은 경보음이 끝날 때까지 기다립니다.

프로그래밍 가능 버튼

대리점에서 프로그래밍 가능 버튼을 버튼 누름 지속 시간에 따라 무전기 기능 바로가기로 프로그래밍할 수 있습니다.

짧게 누르기

눌렀다 빨리 놓습니다.

길게 누르기

프로그래밍된 지속 시간 동안 누른 상태로 유지합니다.



주의:

프로그래밍된 버튼 누름 지속 시간은 할당 가능한 모든 무전기/유틸리티 기능 또는 설정에 적용됩니다. *비상*버튼의 프로그래밍된 지속 시간에 대한 자세한 내용은 **비상 작동 페이지의 257**을 참조하십시오.

지정 가능한 무전기 기능

Bluetooth® 오디오 스위치

무전기 내부 스피커와 외부 Bluetooth 사용 액세서리 간에 오디오 라우팅을 전환합니다.

Bluetooth 연결

Bluetooth 찾기 및 연결 작업을 시작합니다.

Bluetooth 연결 해제

무전기와 Bluetooth 사용 장치 간의 기존 Bluetooth 연결을 모두 종료합니다.

Bluetooth 검색 가능

무전기가 Bluetooth 검색 가능 모드로 전환되도록 합니다.

통화 중 대기열 취소

통화 중 대기열의 비상이 아닌 호출이 시작되면 통화 중 모드를 종료합니다. 통화 중 대기열에 비상 호출이 수락된 경우에는 취소할 수 없습니다.

호출 목록

호출 목록을 선택합니다.

채널 안내

현재 채널에 대한 존 및 채널 안내 음성 메시지를 재생합니다.

연락처

연락처 목록으로 직접 이동할 수 있습니다.

비상 켜기/끄기

프로그래밍에 따라 비상 알람 또는 호출을 시작하거나 취소합니다.

경적/라이트

경적/라이트 기능을 켜거나 끕니다.

실내 위치

실내 위치를 켜거나 끕니다.

지능형 오디오

지능형 오디오를 켜거나 끕니다.

매뉴얼 다이얼

프로그래밍에 따라 가입자 ID 또는 전화 번호를 눌러 개별 호출 또는 전화 통화를 시작합니다.

원터치 액세스

미리 정의된 개별 호출, 호출 경보, 단축 문자 메시지, 또는 홈 되돌리기를 바로 시작합니다.

개인 정보 보호

프라이버시 기능을 켜거나 끕니다.

무전기 점검

무전기가 시스템에서 활성화되었는지 여부를 확인합니다.

무전기 복구

대상 무전기를 원격으로 활성화할 수 있습니다.

무전기 비활성화

대상 무전기를 원격으로 비활성화할 수 있습니다.

원격 모니터링

아무런 표시 없이 대상 무전기의 마이크를 켭니다.

홈 채널 재설정

새 홈 채널을 설정합니다.

벨 정보 유형

벨 정보 유형 설정으로 직접 이동할 수 있습니다.

로밍 요청

다른 사이트를 검색하도록 요청합니다.

스캔

스캔 기능을 켜거나 끕니다.

무음 홈 채널 미리 알림

홈 채널 미리 알림을 음소거합니다.

사이트 잠금 켜기/끄기

사이트 잠금을 켜면 무전기가 현재 사이트만 검색합니다. 사이트 잠금을 끄면 무전기가 현재 사이트에 추가로 다른 사이트를 검색합니다.

문자 메시지

문자 메시지 메뉴를 선택합니다.

음성 안내 켜기/끄기

음성 안내를 켜거나 끕니다.

Wi-Fi

Wi-Fi를 켜거나 끕니다.

구역

존 목록에서 선택할 수 있습니다.

지정 가능한 설정 또는 유틸리티 기능

AF 억제기

음향 피드백 억제기 기능을 켜거나 끕니다.

전체 톤/경보

전체 톤과 경보를 켜거나 끕니다.

백라이트 선명도

선명도 수준을 조절합니다.

채널 조절

프로그래밍에 따라 채널을 이전 채널 또는 다음 채널로 변경합니다.

디스플레이 모드

주간/야간 디스플레이 모드를 켜거나 끕니다.

GNSS(Global Navigation Satellite System)

위성 탐색 시스템을 켜거나 끕니다.

전력 레벨

전송 전력 레벨을 높게 설정하거나 낮게 설정합니다.

지정되지 않음

버튼 기능이 아직 지정되지 않았음을 나타냅니다.

Connect Plus 모드에서 상태 표시 식별

디스플레이 아이콘

다음은 무전기의 디스플레이에 나타나는 아이콘입니다.

	RSSI(Received Signal Strength Indicator, 수신 신호 강도 표시기) 표시되는 막대 수는 무선 신호 강도를 나타냅니다. 막대 4개는 가장 강력한 신호를 의미합니다. 이 아이콘은 수신하는 동안에만 표시됩니다.
	Bluetooth 연결 안됨 Bluetooth 기능은 활성화되어 있지만 원격 Bluetooth 장치가 연결되어 있지 않습니다.
	Bluetooth 연결됨 Bluetooth 기능이 활성화되어 있습니다. 원격 Bluetooth 장치가 연결되어 있으면 이 아이콘은 켜진 상태로 유지됩니다.
	대용량 데이터 무전기에서 대용량 데이터를 수신 중이며 채널이 사용 중입니다.

	실내 위치 사용 가능⁴ 실내 위치 상태가 켜져 있고 사용 가능합니다.
	실내 위치 사용 불가능⁴ 실내 위치 상태가 켜져 있지만 Bluetooth 비활성 상태 또는 Bluetooth가 비콘 스캔을 일시 중지하여 사용할 수 없습니다.
	음소거 모드 음소거 모드가 활성화되고 스피커가 음소거됩니다.
	알림 알림 목록에 검토할 항목이 있습니다.
	출력 수준 무전기가 저출력 또는 고출력으로 설정되어 있습니다.
	신호음 비활성화 신호음이 꺼져 있습니다.

⁴ 최신 소프트웨어 및 하드웨어 모델에만 적용됩니다.

	옵션 보드 옵션 보드가 활성화되어 있습니다.
	옵션 보드 비활성화 옵션 보드가 비활성화되어 있습니다.
	GNSS 사용 가능 GPS/GNSS 기능이 활성화되어 있습니다. 고정 위치를 사용할 수 있는 경우 아이콘이 켜진 상태로 유지됩니다.
	GNSS 사용 불가/범위를 벗어남 GPS/GNSS 기능이 활성화되어 있지만 위 성에서 데이터가 수신되지 않습니다.
	BeiDou에서만 사용 가능⁵ BeiDou 전용 기능이 활성화되어 있습니다. 고정 위치를 사용할 수 있는 경우 아이콘이 켜진 상태로 유지됩니다.
	스캔 스캔 기능이 활성화되어 있습니다.

	비상 무전기가 비상 모드에 있습니다.
	보안 프라이버시 기능이 활성화되어 있습니다.
	비보안 프라이버시 기능이 비활성화되어 있습니 다.
	사이트 로밍 사이트 로밍 기능이 활성화되어 있습니다.
	연락처 무전기 연락처를 사용할 수 있습니다.
	호출 목록 무전기 호출 목록입니다.
	메시지 수신 메시지입니다.

⁵ XiR M8660i/XiR M8668i/CM7668i에만 적용 가능

	벨소리만 벨 모드를 사용합니다.
	무음 무음 모드를 사용합니다.
	진동 진동 모드를 사용합니다.
	진동 및 벨 진동 및 벨 모드를 사용합니다.
	Wi-Fi 우수 ⁶ Wi-Fi 신호가 우수합니다.
	Wi-Fi 양호 ⁶ Wi-Fi 신호가 양호합니다.
	Wi-Fi 평균 ⁶ Wi-Fi 신호가 평균입니다.
	Wi-Fi 불량 ⁶ Wi-Fi 신호가 약합니다.

**Wi-Fi 사용 불가능**⁶

Wi-Fi 신호를 사용할 수 없습니다.

호출 아이콘

다음 아이콘은 호출 중에 무전기 디스플레이에 나타납니다. 이 아이콘은 연락처 목록에 표시되어 ID 유형을 나타내기도 합니다.

**개별 호출**

진행 중인 개별 호출을 나타냅니다. 연락처 목록에서는 가입자 별칭(이름) 또는 ID(번호)를 나타냅니다.

**그룹 호출/사이트 전체 호출**

진행 중인 그룹 호출 또는 사이트 전체 호출을 나타냅니다. 연락처 목록에서는 그룹 별칭(이름) 또는 ID(번호)를 나타냅니다.

**개별 호출로 전화 통화**

⁶ XiR M8668i/CM7668i 에만 적용됩니다.

개별 호출로 전화 통화가 진행 중임을 나타냅니다.



Bluetooth로 PC 호출

Bluetooth로 PC 호출이 진행 중임을 나타냅니다.

연락처 목록에서는 Bluetooth로 PC 호출 별칭(이름) 또는 ID(번호)를 나타냅니다.



발신 호출

디스패처 호출 연락처 유형은 타사 문자 메시지 서버를 사용하여 디스패처 PC에 문자 메시지를 보내는 데 사용됩니다.

고급 메뉴 아이콘

다음 아이콘은 메뉴 항목 옆에 표시되어 두 옵션 중에서 선택할 수 있도록 하거나 두 옵션을 제공하는 하위 메뉴가 있음을 나타냅니다.



확인란(비어 있음)

옵션이 선택되어 있지 않음을 나타냅니다.



확인란(선택됨)

옵션이 선택되어 있음을 나타냅니다.



단색 검은색 상자

하위 메뉴가 있는 메뉴 항목에 대해 선택된 옵션을 나타냅니다.

보낸 문자함 아이콘

다음 아이콘은 보낸 문자함 폴더에서 무전기 디스플레이의 오른쪽 상단에 표시됩니다.



전송 성공

문자 메시지가 성공적으로 전송되었습니다.

또는



진행 중

- 그룹 별칭 또는 ID로 문자 메시지가 전송 대기 중입니다.
- 가입자 별칭 또는 ID로의 문자 메시지가 전송 대기 중이며 승인을 기다리고 있습니다.



또는





개별 또는 그룹 메시지 읽음

문자 메시지를 읽었습니다.

또는



또는

개별 또는 그룹 메시지 읽지 않음

읽지 않은 문자 메시지가 있습니다.



전송 실패

문자 메시지를 보내지 못했습니다.

또는



Bluetooth 장치 아이콘

다음 아이콘은 장치 유형을 나타내는 데 사용할 수 있는 Bluetooth 사용 장치 목록의 항목 옆에도 나타납니다.



Bluetooth 데이터 장치

스캐너와 같은 Bluetooth 사용 데이터 장치입니다.



Bluetooth 오디오 장치

헤드셋과 같은 Bluetooth 사용 오디오 장치입니다.



Bluetooth PTT 장치

POD(PTT 전용 장치)와 같은 Bluetooth 사용 PTT 장치입니다.

LED 표시등

LED 표시등은 무전기의 작동 상태를 표시합니다.

빨간색으로 깜박임

무전기가 배터리가 부족한 상태에서 전송 중이거나, 비상 전송을 수신 중이거나 무전기를 켤 때 자체 테스트에 실패했습니다. 또는 무전기에 ARTS(Auto-Range Transponder System)가 구성된 경우 무전기가 통화권 범위를 이탈했습니다. 음소거 모드가 활성화되었습니다.

적색으로 빠르게 점멸

무전기가 무선(OTA) 파일 전송(옵션 보드 펌웨어 파일, 네트워크 주파수 파일 또는 옵션 보드 코드플러그 파일)을 수



	신하는 중이거나 새 옵션 보드 펌웨어 파일로 업그레이드하는 중입니다.
녹색 및 황색으로 점멸	무전기가 호출 정보를 수신 중이거나 문자 메시지를 받았거나 스캔이 활성화되었으며 동작을 수신 중입니다.
황색으로 켜져 있음	무전기가 Bluetooth 검색 가능 모드에 있습니다.
황색 2회 점멸	무전기에서 새 사이트를 능동 검색하고 있습니다.
황색으로 점멸	무전기가 호출 정보를 수신 중이거나 스캔이 활성화되었으며 대기 상태입니다(무전기는 모든 동작에 음소거로 유지됨).
녹색으로 켜져 있음	전원이 켜지고 있거나 발신 중입니다.
녹색으로 깜박임	무전기가 호출 또는 데이터를 수신 중입니다.
녹색으로 2회 점멸	무전기가 프라이버시 활성화 호출을 수신 중입니다.

상태 표시음

다음은 무전기 스피커를 통해 울리는 신호음입니다.



고음 저음

상태 표시음은 작업을 수행한 후 무전기의 상태를 청각적으로 나타냅니다.

	선택음
	해제음

경보음

경보음은 무전기의 상태 또는 수신된 데이터에 대한 무전기의 응답을 청각적으로 나타냅니다.

연속음 	단조로운 톤입니다. 종료 될 때까지 계속 울립니다.
주기적 신호음 	무전기에 설정된 시간에 따라 주기적으로 톤이 울립니다. 톤이 자체적으로 시작, 중지 및 반복됩니다.
반복음 	사용자가 종료할 때까지 자체적으로 반복되는 단일 음입니다.

일시적 음

무전기에 정의된 짧은 시간 동안 한 번만 울립니다.

신호 레벨이 허용 가능한 레벨 아래로 떨어지면 **Connect Plus** 무전기가 새 사이트를 자동으로 검색합니다.

Connect Plus 모드와 비Connect Plus 모드 간 전환

비Connect Plus 모드로 전환하려면 다른 존(대리점이나 시스템 관리자가 프로그래밍한 경우)으로 변경해야 합니다. 무전기에 비Connect Plus 존이 프로그래밍되어 있는지 여부와 비Connect Plus 존에서 동작할 때 사용할 수 있는 기능을 확인하려면 대리점이나 시스템 관리자에게 문의하십시오.

Connect Plus 모드에서 호출 전송 및 수신

이 섹션에서는 무전기에서 사용할 수 있는 일반 무전기 작동 및 호출 기능을 설명합니다.

사이트 선택

사이트는 특정 지역의 통신 범위를 제공합니다. **Connect Plus** 사이트에는 사이트 컨트롤러 하나와 최대 15개의 중계기가 있습니다. 멀티 사이트 네트워크에서는 현재 사이트의

로밍 요청

현재 사이트의 신호가 허용 가능한 레벨인 경우에도 로밍 요청을 사용하면 무전기에 다른 사이트를 검색하도록 지시할 수 있습니다.

사용 가능한 사이트가 없는 경우:

- 무전기에 검색 중 및 선택한 채널 별칭이 표시되고 계속해서 사이트 목록 전체를 검색합니다.
- 이전 사이트가 아직 사용 가능한 경우, 무전기는 이전 사이트로 되돌아갑니다.



주의:

이 기능은 대리점에서 프로그래밍합니다.

프로그래밍된 **로밍 요청** 버튼을 누릅니다.

무전기가 새 사이트로 전환되면 톤이 울립니다. 디스플레이에 사이트 ID <사이트 번호>가 표시됩니다.

사이트 잠금 켜기/끄기

사이트 잠금을 켜면 무전기가 현재 사이트만 검색합니다. 사이트 잠금을 끄면 무전기가 현재 사이트에 추가로 다른 사이트를 검색합니다.

프로그래밍된 **사이트 잠금** 버튼을 누릅니다.

사이트 잠금 기능이 켜진 경우:

- 무전기가 현재 사이트로 잠기면 성공음이 울립니다.
- 디스플레이에 사이트 잠금 완료가 표시됩니다.

사이트 잠금 기능이 꺼진 경우:

- 무전기가 잠기지 않으면 해제음이 울립니다.
- 디스플레이에 사이트 해제 완료가 표시됩니다.

사이트 제한

Connect Plus 무전기 관리자가 무전기를 사용하거나 사용할 수 없는 네트워크 사이트를 설정할 수 있습니다. 허용된 사이트와 허용되지 않은 사이트의 목록을 변경하기 위해 무전기를 다시 프로그래밍할 필요가 없습니다. 허용되지 않은 사이트에 무전기를 등록하려고 하면 사이트 <지정된 번호>

허용 없음이라는 메시지가 짧게 표시됩니다. 그런 다음 무전기가 자동으로 다른 네트워크 사이트를 검색합니다.

존 선택





무전기에 최대 16개의 **Connect Plus** 존을 프로그래밍할 수 있으며, 각 **Connect Plus** 존에는 채널 선택 노브에 할당할 수 있는 최대 16개의 위치가 있습니다.

할당 가능한 각 노브 위치를 사용하여 다음과 같은 음성 호출 유형 중 하나를 시작할 수 있습니다.

- 그룹 호출
- **Multi-group Call**
- 사이트 전체 호출
- 개별 호출





1 다음을 수행하여 존 기능에 접근합니다.

무전기 컨트롤	단계
프로그래밍된 존 선택 버튼	프로그래밍된 존 선택 버튼을 누릅니다.

무전기 컨트롤	단계
무전기 메뉴	<p>a  버튼을 눌러 메뉴에 액세스합니다.을 누릅니다.</p> <p>b  또는  버튼을 눌러 존 및 선택하려면  버튼을 누릅니다.로 이동합니다.</p>

현재 존이 나타나고 ✓로 표시됩니다.

2 원하는 존을 선택합니다.

무전기 컨트롤	단계
 또는 	 또는  버튼을 눌러 원하는 존으로 스크롤합니다.

3 버튼을 눌러 선택합니다.

디스플레이에 <존> 선택 완료가 잠시 표시된 후 선택한 존 화면으로 돌아갑니다.

다중 네트워크 사용

무전기가 다중 **Connect Plus** 네트워크를 사용하도록 프로그래밍되어 있는 경우 원하는 네트워크에 할당된 **Connect Plus** 존으로 전환하여 다른 네트워크를 선택할 수 있습니다. 이러한 네트워크와 존 간 할당은 대리점에서 무전기 프로그래밍을 통해 구성합니다.

호출 유형 선택

채널 선택 노브를 사용하여 호출 유형을 선택합니다. 호출 유형은 무전기가 프로그래밍된 방식에 따라 그룹 호출, 다중 그룹 호출, 사이트 전체 호출 또는 개별 호출일 수 있습니다. 채널 선택 노브를 다른 위치(호출 유형이 할당된 위치)로 변경하는 경우 무전기가 **Connect Plus** 사이트에 다시 등록됩니다. 무전기는 새 채널 선택 노브 위치 호출 유형에 프로그래밍된 등록 그룹 ID를 사용하여 등록됩니다.

호출 유형이 할당되지 않은 위치를 선택하면 무전기에서 계속 톤이 울립니다. 그리고 디스플레이에 프로그램 필요가 표시됩니다. 프로그래밍되지 않은 채널을 선택하면 무전기

가 작동하지 않으므로 채널 선택 노브를 사용하여 프로그래밍된 채널을 선택해야 합니다.

무전기에 여러 존이 있는 경우 원하는 존이 표시되면 프로그래밍된 채널 선택 노브를 돌려 호출 유형을 선택합니다.

무전기 호출 수신 및 응답

채널, 가입자 ID 또는 호출 유형이 표시되면 호출을 수신하고 응답할 수 있습니다.

무전기가 발신 중이면 녹색 LED가 켜지고 무전기가 수신 중이면 녹색으로 깜박입니다.



주의:

무전기가 발신 중이면 녹색 LED가 켜지고 무전기가 프라이버시 활성화 호출을 수신 중이면 녹색으로 두 번 깜박입니다. . 프라이버시 활성화 호출의 스크램블을 풀려면 발신 무전기(수신 중인 호출을 보낸 무전기)와 동일한 프라이버시 키 또는 키 값과 키 ID(대리점에서 프로그래밍함)가 무전기에 있어야 합니다.

자세한 내용은 [개인 정보 보호 페이지의 274](#) 부분을 참조하십시오.

그룹 호출 수신 및 응답

그룹 사용자로부터 호출을 수신하려면 무전기가 해당 그룹의 일부로 구성되어야 합니다.

홈 화면에서 그룹 호출을 수신하면, LED가 녹색으로 깜박입니다. 그룹 호출 아이콘이 오른쪽 위 모서리에 나타납니다. 첫 번째 텍스트 줄에 발신자 별칭이 표시됩니다. 두 번째 텍스트 줄에 그룹 호출 별칭이 표시됩니다. 무전기 음소거가 해제되고 호출 수신 시 무전기의 스피커를 통해 소리가 납니다.

1 마이크를 2.5 ~ 5.0cm(1 ~ 2인치) 띄우고 듭니다. 녹색 LED가 켜집니다.

2 통화 허용 경보음(활성화된 경우) 중 하나가 끝날 때까지 기다렸다가 마이크에 대고 명확히 말합니다.

3 상대방의 말을 들으려면 **PTT** 버튼을 놓습니다. 미리 정해진 시간 동안 음성 동작이 없으면 호출이 종료됩니다.



주의:

그룹 호출 전송에 대한 자세한 내용은 [그룹 호출 전송 페이지의 226](#)을 참조하십시오.

개별 호출 수신 및 응답

개별 호출은 개별 무전기 간 호출을 말합니다.

개별 호출을 수신하면 LED가 녹색으로 깜박입니다. 디스플레이의 첫 번째 줄에 가입자 별칭 또는 ID, RSSI 아이콘이 표시됩니다. 두 번째 줄에는 개별 호출과 개별 호출 아이콘이 표시됩니다. 무전기 음소거가 해제되고 호출 수신 시 무전기의 스피커를 통해 소리가 납니다.

1 마이크를 2.5 ~ 5.0cm(1 ~ 2인치) 띄우고 듭니다.

2 PTT 버튼을 눌러 호출에 응답합니다.

녹색 LED가 켜집니다.

3 통화 허용 경보음(활성화된 경우)이 끝날 때까지 기다렸다가 마이크에 대고 명확히 말합니다.

4 상대방의 말을 들으려면 PTT 버튼을 놓습니다.

미리 정해진 시간 동안 음성 동작이 없으면 호출이 종료됩니다.

디스플레이에 통화 종료가 표시됩니다.

개별 호출 전송에 대한 자세한 내용은 [개별 호출 전송 페이지의 227](#)을 참조하십시오.

사이트 전체 호출 수신

사이트 전체 호출은 개별 무전기가 사이트의 모든 무전기를 호출하는 것입니다. 이는 사용자의 주의가 필요한 중요 정보를 통보하는 데 사용됩니다.

사이트 전체 호출을 수신하면 신호음이 울리고 LED가 녹색으로 깜박입니다.

그룹 호출 아이콘이 오른쪽 위 모서리에 나타납니다. 첫 번째 텍스트 줄에 발신자 별칭이 표시됩니다. 두 번째 텍스트 줄에 사이트 전체 호출이 표시됩니다. 무전기 음소거가 해제되고 호출 수신 시 무전기의 스피커를 통해 소리가 납니다.

사이트 전체 호출이 끝나면 무전기가 호출을 수신하기 전의 이전 화면으로 돌아갑니다. 사이트 전체 호출은 미리 정해진 시간 동안 기다리지 않고 끝납니다.

사이트 전체 호출에 응답할 수 없습니다.



주의:

사이트 전체 호출 전송에 대한 자세한 내용은 [사이트 전체 호출 전송 페이지의 227](#)을 참조하십시오.

무전기에서 호출을 수신하는 동안 다른 채널로 전환하는 경우에는 사이트 전체 호출 수신이 중지됩니다. 사이트 전체 호출 중에는 호출이 끝날 때까지 프로그래밍된 버튼 기능을 하나도 사용할 수 없습니다.

인바운드 개인 전화 수신

인바운드 개인 전화를 수신하면 오른쪽 위 모서리에 전화가 개별 호출 아이콘으로 표시됩니다. 첫 번째 텍스트 줄에 전화가 표시됩니다.

- 1 전화를 받거나 말하려면 **PTT** 버튼을 길게 누릅니다. 상대방의 말을 들으려면 **PTT** 버튼을 놓습니다.



- 2  버튼을 길게 눌러 통화를 종료합니다.

디스플레이의 첫 번째 줄에 종료가 표시됩니다. 디스플레이의 두 번째 줄에 전화...가 표시됩니다. 디스플레이가 전화 화면으로 돌아갑니다. 디스플레이에 전화 종료가 표시됩니다.

인바운드 개인 전화에서 버퍼링된 오버다이얼 사용

통화 중에 오른쪽 위 모서리에 전화가 개별 호출 아이콘으로 표시됩니다. 디스플레이의 첫 번째 텍스트 줄에 전화가 표시됩니다.

- 1 키패드를 사용하여 숫자를 입력하고  버튼을 누릅니다.

 ,  버튼을 2초 안에 차례로 눌러 일시 중지 시간을 삽입합니다. 디스플레이에서 F는 * 및 #으로 바꿉니다.

오른쪽 위 모서리에 전화가 개별 호출 아이콘으로 표시됩니다. 디스플레이의 첫 번째 텍스트 줄에 입력한 숫자가 표시됩니다.

- 2 호출을 종료하려면  버튼을 길게 누릅니다.

디스플레이의 첫 번째 줄에 종료가 표시됩니다. 디스플레이의 두 번째 줄에 전화...가 표시됩니다. 디스플레이가 전화 화면으로 돌아갑니다.

디스플레이에 전화 종료가 표시됩니다.

인바운드 개인 전화에서 라이브 오버다이얼 사용

통화 중에 오른쪽 위 모서리에 전화가 개별 호출 아이콘으로 표시됩니다. 디스플레이의 첫 번째 텍스트 줄에 전화가 표시됩니다.

- 1 **PTT** 버튼을 누르고 키패드를 사용하여 숫자를 입력합니다.

오른쪽 위 모서리에 전화가 개별 호출 아이콘으로 표시됩니다. 디스플레이의 첫 번째 텍스트 줄에 라이브 다이얼 숫자가 표시됩니다.

- 2 호출을 종료하려면  버튼을 길게 누릅니다.

디스플레이의 첫 번째 줄에 종료 표시가 표시됩니다. 디스플레이의 두 번째 줄에 전화...가 표시됩니다. 디스플레이가 전화 화면으로 돌아갑니다.

디스플레이에 전화 종료 표시가 표시됩니다.

인바운드 전화 통화 그룹 호출 수신

인바운드 전화 통화 그룹 호출을 수신하면 그룹 호출 아이콘이 오른쪽 위 모서리에 나타납니다. 첫 번째 텍스트 줄에 호출1이 표시됩니다.

말을 하려면 **PTT** 버튼을 누르고, 상대방의 말을 들으려면 **PTT** 버튼을 놓습니다.

인바운드 전화 다중 그룹 호출

인바운드 전화 다중 그룹 호출을 수신하면 그룹 호출 아이콘이 오른쪽 위 모서리에 나타납니다. 첫 번째 텍스트 줄에 다중 그룹 호출이 나타납니다. 무전기 음소거가 해제되고 다중 그룹 호출 수신 시 무전기 스피커를 통해 소리가 납니다.

무전기 호출 송신

채널을 선택하고 나면 다음을 사용하여 가입자 별칭 또는 ID 또는 그룹 별칭 또는 ID를 선택할 수 있습니다.

- 채널 선택 노브
- 프로그래밍된 **원터치 액세스** 버튼 – 원터치 액세스 기능을 사용하면 미리 정의된 ID로 개별 호출을 쉽게 전송할 수 있습니다. 이 기능은 프로그래밍 가능 버튼에 짧게 누름이나 길게 누름으로 할당할 수 있습니다. **원터치 액세스**

스 버튼에는 하나의 ID만 할당할 수 있습니다. 무전기에 여러 개의 원터치 액세스 버튼을 프로그래밍할 수 있습니다.

- 연락처 목록(연락처 설정 페이지의 246 참조).



주의:

프라이버시 활성화 발신을 보내려면 무전기의 프라이버시 기능이 채널에서 활성화되어 있어야 합니다. 무전기와 동일한 키 값과 키 ID를 가진 대상 무전기만 발신의 스크램블을 풀 수 있습니다.

자세한 내용은 개인 정보 보호 페이지의 274 부분을 참조하십시오.

채널 선택 노브를 사용하여 호출 전송

이 기능을 사용하면 무전기 사용자가 다음과 같은 서로 다른 호출 유형을 송신할 수 있습니다. 그룹 호출, 개별 호출, 사이트 전체 호출, 다중 그룹 호출.

그룹 호출 전송

그룹 사용자에게 호출을 전송하려면 무전기를 해당 그룹의 일부로 구성해야 합니다.

- 1 활성화 그룹 별칭 또는 ID가 있는 채널을 선택합니다.
호출 유형 선택 페이지의 221을 참조하십시오.

- 2 마이크를 2.5 ~ 5.0cm(1 ~ 2인치) 띄우고 듭니다.

- 3 PTT 버튼을 눌러 전화를 전송합니다.

LED가 녹색으로 켜집니다. 그룹 호출 아이콘이 오른쪽 위 모서리에 나타납니다. 첫 번째 텍스트 줄에 그룹 호출 별칭이 표시됩니다.

- 4 통화 허용 정보음(활성화된 경우)이 끝날 때까지 기다렸다가 마이크에 대고 명확히 말합니다.

- 5 상대방의 말을 들으려면 PTT 버튼을 놓습니다.

대상 무전기가 응답하면 녹색 LED가 깜박입니다. 또한 무전기의 음소거가 해제되며 무전기 스피커를 통해 응답 톤이 울립니다. 디스플레이에 그룹 호출 아이콘, 그룹 별칭 또는 ID 및 발신 무전기 별칭 또는 ID가 표시됩니다.

미리 정해진 시간 동안 음성 동작이 없으면 호출이 종료됩니다. 무전기가 호출 시작 전 화면으로 돌아갑니다.

개별 호출 전송

승인된 개별 무전기에서 시작한 개별 호출에 대해 수신 및/또는 응답을 할 수 있을 경우 개별 호출을 시작하려면 무전기가 프로그래밍되어야 합니다.

이 기능이 활성화되지 않은 경우 **원터치 액세스** 버튼 또는 채널 선택 노브를 통해 개별 통화를 전송하면 해제음이 울립니다.

- 1 다음 중 하나를 수행합니다.
 - 활성 가입자 별칭 또는 ID가 있는 채널을 선택합니다. **호출 유형 선택 페이지의 221**을 참조하십시오.
 - 프로그래밍된 **원터치 액세스** 버튼을 누릅니다.

2 마이크를 2.5 ~ 5.0cm(1 ~ 2인치) 띄우고 듭니다.

3 **PTT** 버튼을 눌러 전화를 전송합니다.

.. 개별 호출 아이콘이 오른쪽 위 모서리에 나타납니다. 첫 번째 텍스트 줄에 대상 가입자 별칭이 표시됩니다. 두 번째 텍스트 줄에 호출 상태가 표시됩니다.

4 통화 허용 경보음(활성화된 경우)이 끝날 때까지 기다렸다가 마이크에 대고 명확히 말합니다.

5 상대방의 말을 들으려면 **PTT** 버튼을 놓습니다.

대상 무전기가 응답하면 녹색 **LED**가 깜박입니다.

미리 정해진 시간 동안 음성 동작이 없으면 호출이 종료됩니다. 짧은 톤이 울립니다. 디스플레이에 통화 종료 표시가 표시됩니다.

개별 호출을 설정하기 전에 무전기 존재 여부를 확인하도록 무전기를 프로그래밍할 수 있습니다. 대상 무전기를 사용할 수 없으면 짧은 톤이 울리고 디스플레이에 해제 미니 알림이 표시됩니다.

사이트 전체 호출 전송

이 기능을 사용하면 현재 다른 호출에 참여하지 않고 있는 채널의 모든 사용자에게 발신할 수 있습니다. 이 기능을 사용할 수 있도록 무전기를 프로그래밍해야 합니다.

채널/사이트 상의 사용자는 사이트 전체 호출에 응답할 수 없습니다.

- 1 사이트 전체 호출 그룹 별칭이 활성화되어 있는 채널을 선택합니다. **호출 유형 선택 페이지의 221**을 참조하십시오.

2 마이크를 2.5 ~ 5.0cm(1 ~ 2인치) 띄우고 듭니다.

3 PTT 버튼을 눌러 전화를 전송합니다.

녹색 LED가 켜집니다. 그룹 호출 아이콘이 오른쪽 위 모서리에 나타납니다. 첫 번째 텍스트 줄에 사이트 전체 호출이 표시됩니다.

4 통화 허용 경보음(활성화된 경우)이 끝날 때까지 기다렸다가 마이크에 대고 명확히 말합니다.

통화 허용 경보음(활성화된 경우)이 끝날 때까지 기다렸다가 마이크에 대고 명확히 말합니다.

다중 그룹 호출 전송

이 기능을 사용하면 다중 그룹의 모든 사용자에게 발신할 수 있습니다. 이 기능을 사용할 수 있도록 무전기를 프로그래밍해야 합니다.



주의:

그룹의 사용자가 다중 그룹 호출에 응답할 수 없습니다.

1 채널 선택 노브를 돌려 다중 그룹 별칭 또는 ID를 선택합니다.

2 PTT 버튼을 눌러 전화를 전송합니다.

녹색 LED가 켜집니다. 디스플레이에 다중 그룹 별칭 또는 ID가 표시됩니다.

원터치 호출 버튼으로 개별 호출 전송



주의:

홈 화면에서 프로그래밍 가능 버튼을 눌러야 합니다.

원터치 호출 기능을 사용하면 미리 정의된 개별 호출 별칭 또는 ID로 개별 호출을 쉽게 할 수 있습니다. 이 기능은 프로그래밍 가능 버튼에 짧게 누름이나 길게 누름으로 할당할 수 있습니다.

원터치 호출 버튼에는 하나의 별칭이나 ID만 할당할 수 있습니다. 무전기에 여러 개의 원터치 호출 버튼을 프로그래밍할 수 있습니다.

1 프로그래밍된 **원터치 호출** 버튼을 눌러 미리 정의된 개별 호출 별칭 또는 ID에 개별 호출을 전송합니다.

2 마이크를 2.5 ~ 5.0cm(1 ~ 2인치) 띄우고 듭니다.

3 PTT 버튼을 눌러 전화를 전송합니다.
녹색 LED가 켜집니다.

디스플레이에 개별 호출 별칭 또는 ID가 표시됩니다.

4 통화 허용 경보음(활성화된 경우)이 끝날 때까지 기다렸다가 마이크에 대고 명확히 말합니다.

5 상대방의 말을 들으려면 **PTT** 버튼을 놓습니다.

대상 무전기에서 응답하면 **LED**가 녹색으로 깜박입니다.

미리 정해진 시간 동안 음성 동작이 없으면 호출이 종료됩니다.

프로그래밍 가능 매뉴얼 다이얼 버튼으로 호출 전송

이 기능을 사용하면 무전기 사용자가 프로그래밍 가능 수동 다이얼 버튼을 사용하여 개별 호출을 시작할 수 있습니다.

개별 호출 전송

1 프로그래밍된 **매뉴얼 다이얼** 버튼을 눌러 매뉴얼 다이얼 화면으로 전환합니다.

디스플레이에 번호:가 표시됩니다.

2 키패드를 사용하여 가입자 별칭 또는 개별 ID를 입력합니다.

3 마이크를 2.5 ~ 5.0cm(1 ~ 2인치) 띄우고 듭니다.

4 **PTT** 버튼을 눌러 전화를 전송합니다.

녹색 **LED**가 켜집니다. 개별 호출 아이콘이 오른쪽 위 모서리에 나타납니다. 첫 번째 텍스트 줄에 가입자 별칭이 표시됩니다. 두 번째 텍스트 줄에 호출 상태가 표시됩니다.

5 통화 허용 경보음(활성화된 경우)이 끝날 때까지 기다렸다가 마이크에 대고 명확히 말합니다.

6 상대방의 말을 들으려면 **PTT** 버튼을 놓습니다.

대상 무전기에서 응답하면 **LED**가 녹색으로 깜박입니다.

미리 정해진 시간 동안 음성 동작이 없으면 호출이 종료됩니다. 짧은 톤이 울립니다. 디스플레이에 통화 종료 표시가 표시됩니다.



프로그래밍 가능한 메뉴얼 다이얼 버튼으로 아웃바운드 개인 전화 송신

- 1 프로그래밍된 **메뉴얼 다이얼** 버튼을 눌러 메뉴얼 다이얼 화면으로 전환합니다.

디스플레이에 번호:가 표시됩니다.

- 2 키패드를 사용하여 전화 번호를 입력하고  버튼을 눌러 입력한 번호로 전화를 겁니다.

필요 없는 문자를 삭제하려면  버튼을 누릅니다.

 ,  버튼을 2초 안에 차례로 눌러 일시 중지 시간을 삽입합니다. 디스플레이에서 F는 * 및 #으로 바뀝니다.





성공하면 디스플레이의 첫 번째 줄에 전화가 표시됩니다. 디스플레이의 두 번째 줄에는 전화를 건 번호가 표시됩니다.

올바르지 않은 전화 번호를 선택하면 디스플레이에 해제 미니 알림과 함께 전화 접속 통화 실패, 리소스를 사용할 수 없음 또는 잘못된 권한이 표시됩니다.

전화 번호를 입력하지 않고  버튼을 누르면 무전기에서 선택 음이 울린 후 해제음이 울립니다. 디스플레이는 변하지 않습니다.

- 3 호출을 종료하려면  버튼을 길게 누릅니다. 디스플레이의 첫 번째 줄에 종료가 표시됩니다. 디스플레이의 두 번째 줄에 전화...가 표시됩니다. 디스플레이에 전화 종료가 표시됩니다.



전화 메뉴를 통해 아웃바운드 개인 전화 송신

- 1  버튼을 눌러 메뉴에 액세스합니다.을 누릅니다.
- 2  또는  버튼을 눌러 전화로 이동하고 선택하려면  버튼을 누릅니다..

3  버튼을 눌러 매뉴얼 다이얼을 선택합니다.
디스플레이의 첫 번째 줄에 번호가 표시되고 두 번째 줄에서 커서가 깜박입니다.

4 키패드를 사용하여 전화 번호를 입력하고  버튼을 눌러 입력한 번호로 전화를 겁니다.

필요 없는 문자를 삭제하려면 ◀ 버튼을 누릅니다.

 ,  버튼을 2초 안에 차례로 눌러 일시 중지 시간을 삽입합니다. 디스플레이에서 F는 * 및 #으로 바뀝니다.

성공하면 디스플레이의 첫 번째 줄에 전화가 표시됩니다. 디스플레이의 두 번째 줄에는 전화를 건 번호가 표시됩니다.

올바르지 않은 전화 번호를 선택하면 디스플레이에 해제 미니 알림과 함께 전화 접속 통화 실패, 리소스를 사용할 수 없음 또는 잘못된 권한이 표시됩니다.







전화 번호를 입력하지 않고  버튼을 누르면 무전기에서 선택음이 울린 후 해제음이 울립니다. 디스플레이는 변하지 않습니다.



5 호출을 종료하려면  버튼을 길게 누릅니다.
디스플레이의 첫 번째 줄에 종료가 표시됩니다. 디스플레이의 두 번째 줄에 전화...가 표시됩니다.
디스플레이에 전화 종료가 표시됩니다.

연락처에서 아웃바운드 개인 전화 송신



주의:
MOTOTRBO Connect Plus 옵션 보드 CPS에서 전화 매뉴얼 다이얼이 비활성화되어 있으면 전화 번호 항목이 메뉴에 표시되지 않습니다.

- 1  버튼을 눌러 메뉴에 액세스합니다.을 누릅니다.
- 2  또는  을 눌러 연락처 및 선택하려면  버튼을 누릅니다.로 이동합니다.
- 3  또는  버튼을 눌러 매뉴얼 다이얼로 이동하고 선택하려면  버튼을 누릅니다..



- 4  또는  버튼을 눌러 전화 번호로 이동하고 선택하려면  버튼을 누릅니다..

디스플레이의 첫 번째 줄에 번호가 표시되고 두 번째 줄에서 커서가 깜박입니다.

- 5 키패드를 사용하여 전화 번호를 입력하고  버튼을 눌러 입력한 번호로 전화를 겁니다.

PTT 버튼을 누르면 디스플레이에 해제 미니 알림, 보내려면 **OK**를 누르세요가 표시되고 이전 화면으로 돌아갑니다.

필요 없는 문자를 삭제하려면  버튼을 누릅니다.

,  버튼을 2초 안에 차례로 눌러 일시 중지 시간을 삽입합니다. 디스플레이에서 F는 * 및 #으로 바뀝니다.

성공하면 디스플레이의 첫 번째 줄에 전화가 표시됩니다. 디스플레이의 두 번째 줄에는 전화를 건 번호가 표시됩니다.

전화 번호를 입력하지 않고  버튼을 누르면 무전기에서 선택 음이 울린 후 해제음이 울립니다. 디스플레이는 변하지 않습니다.

- 6 호출을 종료하려면  버튼을 길게 누릅니다.

디스플레이의 첫 번째 줄에 종료가 표시됩니다. 디스플레이의 두 번째 줄에 전화...가 표시됩니다.

디스플레이에 전화 종료가 표시됩니다.

아웃바운드 개인 전화에서 채널 허가 대기

개인 통화 통화를 하면 디스플레이의 첫 번째 줄에 전화가 표시됩니다. 디스플레이의 두 번째 줄에는 전화를 건 번호가 표시됩니다.

통화가 연결되면 오른쪽 위 모서리에 전화가 개별 호출 아이콘으로 표시됩니다. 디스플레이의 첫 번째 줄에는 전화 번호가 표시됩니다.

통화가 연결되지 않으면 디스플레이에 해제 미니 알림과 함께 전화 접속 통화 실패, 리소스를 사용할 수 없음 또는 잘못된 권한이 표시됩니다.

호출을 종료하려면  버튼을 길게 누릅니다.



디스플레이가 이전 화면으로 돌아갑니다.

연결된 아웃바운드 개인 전화에서 버퍼링된 오버다이얼 사용

통화 중에 오른쪽 위 모서리에 전화가 개별 호출 아이콘으로 표시됩니다. 디스플레이의 첫 번째 텍스트 줄에는 전화 번호가 표시됩니다.

1 키패드를 사용하여 숫자를 입력합니다.

필요 없는 문자를 삭제하려면  버튼을 누릅니다.

 ,  버튼을 2초 안에 차례로 눌러 일시 중

지 시간을 삽입합니다. 디스플레이에서 F는 * 및 #으로 바꿉니다.



디스플레이의 첫 번째 텍스트 줄에 추가 숫자가 표시되고, 디스플레이의 두 번째 텍스트 줄에 입력한 추가 숫자가 표시됩니다.

2  버튼을 누릅니다.

PTT 버튼을 누르면 디스플레이에 해제 미니 알림, 보내려면 OK를 누르세요가 표시되고 이전 화면으로 돌아갑니다.

오른쪽 위 모서리에 전화가 개별 호출 아이콘으로 표시됩니다. 디스플레이의 첫 번째 텍스트 줄에는 오버다이얼 숫자가 추가된 전화 번호가 표시됩니다.

3 다음 중 하나를 수행합니다.

-  버튼을 눌러 전화 화면으로 돌아갑니다.
- 호출을 종료하려면  버튼을 길게 누릅니다.

연결된 아웃바운드 개인 전화에서 라이브 오버다이얼 사용

통화 중에 오른쪽 위 모서리에 전화가 개별 호출 아이콘으로 표시됩니다. 디스플레이의 첫 번째 텍스트 줄에는 전화 번호가 표시됩니다.

- 1 **PTT** 버튼을 누르고 키패드를 사용하여 숫자를 입력합니다.

오른쪽 위 모서리에 전화가 개별 호출 아이콘으로 표시됩니다. 디스플레이의 첫 번째 텍스트 줄에는 오버다이얼 숫자가 추가된 전화 번호가 표시됩니다.

- 2 호출을 종료하려면  버튼을 길게 누릅니다.

디스플레이의 첫 번째 줄에 종료가 표시됩니다. 디스플레이의 두 번째 줄에 전화...가 표시됩니다.

디스플레이에 전화 종료가 표시됩니다.

Connect Plus 모드의 고급 기능

이 장에서는 무전기에서 사용할 수 있는 기능 작동에 대해 설명합니다.

홈 채널 미리 알림

이 기능은 무전기가 일정 시간 동안 홈 채널에 설정되어 있지 않는 경우 미리 알림을 제공합니다.

이 기능이 **CPS**를 사용하여 활성화된 경우 무전기가 일정 시간 동안 홈 채널에 설정되지 않으면 홈 채널 미리 알림음과 안내음이 울리고 디스플레이의 첫 번째 줄에 비가 표시되고 두 번째 줄에 홈 채널이 표시됩니다.

다음 작업 중 하나를 수행하여 미리 알림에 응답할 수 있습니다.

- 홈 채널로 복귀합니다.
- 프로그래밍 가능 버튼을 사용하여 미리 알림을 일시적으로 음소거합니다.
- 프로그래밍 가능 버튼을 사용하여 새로운 홈 채널을 설정합니다.

자동 폴백

자동 폴백은 특정 유형의 **Connect Plus** 시스템 장애가 발생한 경우 선택한 그룹 연락처에서 계속 비상이 아닌 호출을 전송 및 수신할 수 있게 하는 시스템 기능입니다.

이러한 장애 중 하나가 발생하면 무전기가 자동으로 다른 **Connect Plus** 사이트로 로밍을 시도합니다. 이 검색 프로세스를 통해 작동하는 **Connect Plus** 사이트를 찾은 경우 무전기에 로밍됩니다. 작동하는 사이트를 찾지 못한 경우 무전기에 자동 폴백이 활성화되어 있다면 무전기가 "폴백 채널"을 찾게 됩니다. 폴백 채널은 일반적으로 작동 가능한 **Connect Plus** 사이트에 속하지만 현재 해당 사이트 컨트롤러나 **Connect Plus** 네트워크와 통신할 수 없는 중계기입니다. 폴백 모드에서는 이 중계기가 단일 디지털 중계기로 작동합니다. 자동 폴백 모드에서는 비상이 아닌 그룹 호출만 지원합니다. 폴백 모드에서 지원되는 다른 호출 유형은 없습니다.

자동 폴백 모드 표시

무전기가 폴백 채널을 사용하는 경우 간헐적인 "폴백 톤"(전송 중이 아니라면 대략 15초마다 한 번씩)이 울립니다. 디스플레이에 "폴백 채널"이라는 간략한 메시지가 정기적으로 표시됩니다. 무전기에서 선택적인 그룹 연락처에 대한 **PTT**(그룹 호출, 다중 그룹 호출 또는 사이트 모든 호출)만 사용할 수 있으며, 다른 호출 유형을 사용할 수 없게 됩니다.

폴백 모드에서 호출 전송/수신



주의:

동일한 폴백 채널을 모니터링하며 동일한 그룹으로 선택된 무전기만 호출이 들립니다. 네트워크의 다른 사이트나 다른 중계기로 호출이 전달되지 않습니다. 폴백 모드에서는 비상 음성 호출이나 비상 경보를 사용할 수 없습니다. 폴백 모드에서 비상 버튼을 누르면 무전기에서 잘못된 키 누름 톤이 울립니다. 디스플레이가 있는 무전기의 경우에는 "사용할 수 없는 기능"이라는 메시지도 표시됩니다.

폴백 모드에서는 개별 호출(무전기 간 호출) 및 전화를 사용할 수 없습니다. 개별 연락처를 호출하면 거부 톤이 들립니다. 이 시점에서 원하는 그룹 연락처를 선택해야 합니다. 지원되지 않는 다른 호출에는 원격 모니터, 호출 정보, 무전기 점검, 무전기 복구, 무전기 폐쇄, 문자 메시지, 위치 업데이트, 팩킷 데이터 호출이 포함됩니다.

자동 폴백 모드에서는 **ETCA(Enhanced Traffic Channel Access)**가 지원되지 않습니다. 둘 이상의 무전기 사용자가 동시에(또는 거의 동시에) **PTT** 버튼을 누르면 **PTT** 버튼을 놓을 때까지 두 무전기가 동시에 전송하는 상황이 발생할 수 있습니다. 이런 경우 수신 무전기가 두 전송을 모두 받지 못할 수 있습니다.

폴백 모드에서 호출을 전송하는 것은 일반적인 기능과 유사합니다. 즉, 무전기의 일반적인 채널 선택 방법을 사용하여 원하는 그룹 연락처를 선택한 다음 **PTT**를 눌러 호출을 시작하면 됩니다. 이 경우 다른 그룹이 이미 해당 채널을 사용하고 있을 수 있습니다. 채널이 사용 중인 경우에는 호출 중 톤이 울립니다. 그리고 디스플레이에 "채널 사용 중"이 표시됩니다. 무전기의 일반적인 채널 선택 방법을 사용하여 그룹, 다중 그룹 또는 사이트 모든 호출 연락처를 선택할 수 있습니다. 무전기가 폴백 채널에서 작동 중인 동안에는 다중 그룹이 다른 단일 그룹과 동일하게 동작합니다. 즉, 동일한 다중 그룹으로 선택된 무전기의 소리만 들립니다.

정상 작동 복구

폴백 중계기 범위에 있는 동안 사이트가 정상 트렁킹 작동 상태로 복구되면 무전기가 자동으로 자동 폴백 모드를 종료합니다. 무전기가 성공적으로 등록되면 등록 "삐" 소리가 들립니다. 작동 가능한 사이트(폴백 모드가 아닌) 범위에 있으면 로밍 요청 버튼(무전기에 프로그래밍되어 있는 경우)을 눌러 무전기가 사용 가능한 사이트를 검색하여 등록하게 만들 수 있습니다. 사용할 수 있는 다른 사이트가 없으면 검색이 완료된 후 무전기가 자동 폴백 모드로 돌아갑니다. 폴백 중계기 통신 영역 밖으로 이동하면 무전기가 검색 모드가 되고 디스플레이에 검색이 표시됩니다.





무전기 점검

이 기능을 사용하면(활성화된 경우) 시스템에서 다른 무전기가 활성화되어 해당 무전기의 사용자를 방해하지 있지 않은지 여부를 확인할 수 있습니다. 대상 무전기에는 어떠한 청각적/시각적 표시도 나타나지 않습니다.

이 기능은 가입자 별칭 또는 ID에만 적용할 수 있습니다.









무전기 점검 전송

- 1 무전기 점검 기능에 액세스합니다.

무전기 컨트롤	단계
프로그래밍된 무전기 점검 버튼	<p>a 프로그래밍된 무전기 점검 버튼을 누릅니다.</p> <p>b  또는  버튼을 눌러 원하는 가입자 별칭 또는 ID로 이동하고 선택하려면  버튼을 누릅니다..</p>
메뉴	<p>a  버튼을 눌러 메뉴에 액세스합니다.을 누릅니다.</p>

무전기
컨트롤

단계

- b**  또는  을 눌러 연락처 및 선택하려면  버튼을 누릅니다.로 이동합니다.
- c**  또는  버튼을 눌러 원하는 가입자 별칭 또는 ID로 이동하고 선택하려면  버튼을 누릅니다..
- d**  또는  을 눌러 무전기 점검 및 선택하려면  버튼을 누릅니다.로 이동합니다.

디스플레이에 대상 별칭이 표시되어 요청이 진행 중임을 나타냅니다. 녹색 LED가 켜집니다.

2 승인을 기다립니다.

대상 무전기가 시스템에서 활성화된 상태이면 톤이 울리고 디스플레이에 대상 무전기 사용 가능이 짧게 표시됩니다.

대상 무전기가 시스템에서 활성화된 상태가 아니면 톤이 울리고 디스플레이에 대상 무전기 사용 불가가 짧게 표시됩니다.

메뉴를 통해 시작하는 경우 무전기가 가입자 별칭 또는 ID 화면으로 돌아갑니다.

프로그래밍 가능 버튼을 통해 시작하는 경우 무전기가 홈 화면으로 돌아갑니다.

원격 모니터링

원격 모니터 기능을 사용하면 대상 무전기의 마이크를 켤 수 있습니다(가입자 별칭 또는 ID에만 해당). 대상 가입자의 녹색 LED가 한 번 깜박입니다. 이 기능을 사용하면 대상 무전기와 관련된 모든 오디오 동작을 원격으로 모니터링할 수 있습니다.

이 기능을 사용할 수 있도록 무전기를 프로그래밍해야 합니다.











원격 모니터 시작









주의:

프로그래밍된 지속 시간 후 또는 전송 시작 시도가 있는 경우, 채널을 바꾸거나 무전기 전원을 끈 경우 원격 모니터가 자동으로 중지합니다.

1 원격 모니터 기능에 액세스합니다.

무전기 컨트롤	단계
프로그래밍된 원격 모니터 버튼	<p>a 프로그래밍된 원격 모니터 버튼을 누릅니다.</p> <p>b  또는  버튼을 눌러 원하는 가입자 별칭 또는 ID로 이동하고 선택하려면  버튼을 누릅니다..</p>
메뉴	<p>a  버튼을 눌러 메뉴에 액세스합니다.을 누릅니다.</p> <p>b  또는  을 눌러 연락처 및 선택하려면  버튼을 누릅니다.로 이동합니다.</p> <p>c  또는  버튼을 눌러 원하는 가입자 별칭 또는 ID로 이동하고 선택하려면  버튼을 누릅니다..</p>

무전기 컨트롤	단계
	<p>d  또는  버튼을 눌러 메뉴얼 다이얼로 이동하고 선택하려면  버튼을 누릅니다..</p> <p>e  또는  버튼을 눌러 원격 모니터로 이동하고 선택하려면  버튼을 누릅니다..</p>

첫 번째 텍스트 줄에 원격 모니터가 표시됩니다. 두 번째 텍스트 줄에 대상 별칭이 표시됩니다. 이것은 요청이 진행 중임을 나타냅니다. 녹색 LED가 깜박입니다.

2 승인을 기다립니다.

성공하면 선택음이 울리고 디스플레이에 잠시 원격 모니터 성공이 표시됩니다. 무전기에서 프로그래밍된 시간 동안 모니터링된 무전기로부터 음성을 수신하기 시작하고 디스플레이에 원격 모니터와 대상 별칭이 표시됩니다. 타이머가 만료되면 무전기에서 경보음이 울리고 LED가 꺼집니다.

실패하면 무전기에서 해제음이 울리고 디스플레이에 원격 모니터 실패가 표시됩니다.

스캔

이 기능을 사용하면 무전기가 사전 프로그래밍된 스캔 목록에 정의된 그룹의 호출을 모니터링하고 참여할 수 있습니다. 스캔이 활성화된 경우 상태 표시줄에 스캔 아이콘이 표시되고 유후 상태인 경우 LED가 녹색으로 깜박입니다.

스캔 시작 또는 중지









주의:

이 절차는 현재 선택한 존과 네트워크 ID가 같은 모든 **Connect Plus** 존에 대해 스캔 기능을 켜거나 끕니다. 이 절차를 통해 스캔 기능을 켜 경우에도 스캔 목록의 일부 또는 전체 그룹에 대해 스캔이 비활성화되어 있을 수 있습니다. 자세한 내용은 [스캔 목록 편집 페이지의 241](#) 부분을 참조하십시오.

프로그래밍된 **스캔** 버튼을 눌러 스캔을 시작하거나 중지할 수 있습니다. 또는 다음에 설명하는 절차를 따릅니다.

- 1  버튼을 눌러 메뉴에 액세스합니다. 을 누릅니다.

- 2  또는  을 눌러 스캔 및 선택하려면  버튼을 누릅니다.로 이동합니다.

- 3  또는  버튼을 눌러 켜기 또는 끄기로 이동하고 선택하려면  버튼을 누릅니다..
 - 스캔이 활성화되어 있으면 디스플레이에 스캔 켜기가 표시됩니다.
 - 스캔이 활성화되어 있으면 스캔 메뉴에 끄기가 표시됩니다.
 - 스캔이 비활성화되어 있으면 디스플레이에 스캔 끄기가 표시됩니다.
 - 스캔이 비활성화되어 있으면 스캔 메뉴에 켜기가 표시됩니다.

스캔 중 발신 응답

스캔 도중에는 동작이 감지되는 그룹에서 무전기가 중지됩니다. 컨트롤 채널에서 유후 상태인 경우 스캔 목록의 모든 멤버에 대해 계속해서 수신 대기합니다.

- 1 마이크를 2.5 ~ 5.0cm(1 ~ 2인치) 띄우고 듭니다.

- 2 보류 시간 중에 **PTT** 버튼을 누릅니다.
녹색 LED가 켜집니다.

- 3 통화 허용 정보음(활성화된 경우)이 끝날 때까지 기다렸다가 마이크에 대고 명확히 말합니다.

- 4 상대방의 말을 들으려면 **PTT** 버튼을 놓습니다.
정지 시간 내에 응답하지 않으면 무전기가 다른 그룹 스캔 작업으로 돌아갑니다.

사용자 구성 스캔

목록 편집 메뉴가 활성화되면 멤버 추가 메뉴에서 스캔 멤버를 추가하고 제거할 수 있습니다. 스캔 목록 멤버는 현재 선택된 존과 네트워크 ID가 동일한 **Connect Plus** 존에 있는 채널 선택 위치에 현재 할당된 일반 그룹 연락처이어야 합니다 (예를 들어, 다중 그룹 또는 사이트 전체 호출/**NWAC(Network Wide All Call)**가 아님). 통화 그룹 별칭은 현재 존 스캔 목록에 포함된 통화 그룹과 일치해서는 안 됩니다.

메뉴를 사용하거나 프로그래밍된 **스캔 켜기/끄기** 버튼을 눌러 스캔을 켜거나 끌 수 있습니다.

무전기가 현재 호출에 참여하지 않은 상태일 때만 이 기능이 작동합니다. 현재 호출을 수신하고 있다면 무전기가 다른 그

룹 호출을 스캔할 수 없기 때문에 그룹 호출 진행 상태를 알 수 없습니다. 호출을 마치면 무전기가 컨트롤 채널 시퀀스로 돌아가고 스캔 목록에 있는 그룹을 스캔할 수 있게 됩니다.

스캔 켜기 또는 끄기







주의:



이 절차는 현재 선택한 존과 네트워크 ID가 같은 모든 존에 대해 스캔 기능을 켜거나 끕니다. 이 절차를 통해 스캔 기능을 켜는 경우에도 스캔 목록의 일부 또는 전체 그룹에 대해 스캔이 비활성화되어 있을 수 있습니다. 자세한 내용은 다음 섹션을 참조하십시오.

스캔이 켜져 있으면 디스플레이에 스캔 아이콘이 나타납니다. 스캔이 켜져 있고 호출에 참여하지 않는 상태에서는 LED가 녹색 및 황색으로 깜박입니다.

스캔 켜기 또는 끄기 절차는 무전기가 프로그래밍되어 있는 방식에 따라 달라집니다. 스캔 켜기/끄기 버튼이 프로그래밍되어 있는 경우 해당 버튼을 사용하여 이 기능을 켜거나 끄십시오. 메뉴를 통해 스캔을 켜거나 끄도록 무전기를 프로그래밍한 경우에는 다음에 설명하는 절차를 따릅니다.

- 1  버튼을 눌러 메뉴에 액세스합니다.을 누릅니다.

2  또는  을 눌러 스캔 및 선택하려면  버튼을 누릅니다.로 이동합니다.

3  또는  버튼을 눌러 켜기 또는 끄기로 이동하고 선택하려면  버튼을 누릅니다..

- 스캔이 비활성화되어 있으면 디스플레이에 스캔 켜기가 표시됩니다.
- 스캔이 활성화되어 있으면 디스플레이에 스캔 끄기가 표시됩니다.

스캔 목록 편집



주의:

스캔 목록 항목이 현재 선택된 그룹인 경우에는 목록 항목에 확인 표시가 표시되는지 여부와 관계 없이 해당 그룹의 활동을 수신 대기합니다. 무전기가 호출 상태가 아닐 때마다 무전기는 선택된 그룹, 다중 그룹, 사이트 전체 호출 및 해당 기본 비상 복원 그룹(구성된 경우)에서 활동을 수신 대기합니다. 이 작업은 비활성화할 수 없습니다. 스캔이 활성화된 경우 무전기 역시 활성화된 존 스캔 목록 멤버의 활동에 대한 수신 대기 를 하게 됩니다.

스캔 목록에 따라 스캔할 수 있는 그룹이 결정됩니다. 이 목록은 무전기를 프로그래밍할 때 생성합니다. 사용자가 스캔 목록을 편집할 수 있도록 무전기가 프로그래밍된 경우,



- 목록에서 개별 그룹의 스캔을 선택적으로 활성화/비활성화할 수 있습니다.
- 멤버 추가 메뉴에서 스캔 멤버를 추가하고 제거할 수 있습니다. [멤버 추가 메뉴를 통해 그룹 추가 또는 삭제 페이지의 242](#)를 참조하십시오.





주의:

스캔 목록 멤버는 현재 선택된 존과 네트워크 ID가 동일한 **Connect Plus** 존에 있는 채널 선택 위치에 현재 할당된 일반 그룹 연락처이어야 합니다(다중 그룹 또는 사이트 전체 호출/NWAC(Network Wide All Call)가 아님). 통화 그룹 별칭은 현재 존 스캔 목록에 포함된 통화 그룹과 일치해서는 안 됩니다.

1  버튼을 눌러 메뉴에 액세스합니다.을 누릅니다.

2  또는  버튼을 눌러 목록 보기/편집으로 이동하고 선택하려면  버튼을 누릅니다..

- 3  또는  버튼을 눌러 원하는 그룹으로 이동합니다.

그룹 이름 앞에 확인 표시가 있으면 현재 이 그룹에 스캔이 활성화되어 있는 것입니다.

그룹 이름 앞에 확인 표시가 없으면 현재 이 그룹에 스캔이 비활성화된 것입니다.

- 4  버튼을 눌러 원하는 그룹을 선택합니다.

그룹에 스캔이 비활성화되어 있는 경우 디스플레이에 활성화가 표시됩니다.

그룹에 스캔이 활성화되어 있는 경우 디스플레이에 비활성화가 표시됩니다.

- 5 표시된 옵션(활성화 또는 비활성화)을 선택하고 선택하려면  버튼을 누릅니다..

선택된 옵션에 따라 확인을 위해 무전기에 스캔 활성화 또는 스캔 비활성화가 잠시 표시됩니다.



무전기에 존 스캔 목록이 다시 표시됩니다. 그룹에 스캔이 활성화된 경우 그룹 이름 앞에 확인 표시가 표시됩니다. 그룹에 스캔이 비활성화된 경우 그룹 이름 앞의 확인 표시가 제거됩니다.



멤버 추가 메뉴를 통해 그룹 추가 또는 삭제

Connect Plus 무전기에서는 존 스캔 목록에 중복된 그룹 번호나 그룹 별칭을 지정하거나 "스캔 후보"로 표시할 수 없습니다. 따라서 존 스캔 목록에 그룹을 추가하거나 존 스캔 목록에서 그룹을 삭제하면 단계 6 및 단계 7에서 설명한 "스캔 후보" 목록이 변경되는 경우가 있습니다.

스캔 목록을 편집할 수 있도록 무전기가 프로그래밍된 경우에는 멤버 추가 메뉴를 사용하여 그룹을 현재 선택된 존 스캔 목록의 스캔 목록에 추가하거나 현재 선택된 존 스캔 목록의 스캔 목록에서 삭제할 수 있습니다.

- 1  버튼을 눌러 메뉴에 액세스합니다.을 누릅니다.

- 2  또는  버튼을 눌러 스캔 옵션으로 이동하고 선택하려면  버튼을 누릅니다..

- 3  또는  버튼을 눌러 <구성원 추가>로 이동하고 선택하려면  버튼을 누릅니다..

디스플레이에 존 n의 구성원 추가(n = 현재 선택된 존과 네트워크 ID가 같은 무전기에 있는 첫 번째

Connect Plus 존의 Connect Plus 존 수)가 표시됩니다.

4 다음 중 하나를 수행합니다.

- 스캔 목록에 추가하려는 그룹이 해당 존의 채널 선택기 위치에 할당된 경우에는 **단계 6**로 이동합니다.
- 스캔 목록에 추가하려는 그룹이 다른 **Connect Plus** 존의 채널 선택기 위치에 할당된 경우에는 **단계 5**로 이동합니다.

5 또는 버튼을 눌러 현재 선택된 존과 네트워크 ID가 같은 **Connect Plus** 존 목록을 스크롤합니다.

6 원하는 그룹이 채널 선택기 위치에 할당된 **Connect Plus** 존을 찾은 선택하려면 버튼을 누릅니다..

무전기에 해당 존의 채널 위치에 할당된 그룹 목록 중 첫 번째 항목이 표시됩니다. 목록에 있는 그룹은 현재 선택된 존의 스캔 목록에 추가될 수 있거나 이미 존 스캔 목록에 있으므로 "스캔 후보"라고 합니다.

존에 스캔 목록에 추가할 수 있는 그룹이 없는 경우에는 무전기에 후보 없음이 표시됩니다.

7 또는 을 눌러 후보 그룹 목록을 스크롤합니다.

더하기 기호(+)가 그룹 별칭 바로 앞에 표시된 경우에는 해당 그룹이 현재 선택된 존 스캔 목록에 있음을 나타냅니다.

더하기 기호(+)가 별칭 바로 앞에 표시되지 않은 경우에는 해당 그룹이 현재 스캔 목록에 없지만 추가할 수 있음을 나타냅니다.

8 원하는 그룹 별칭이 표시되면 버튼을 누릅니다.

이 그룹이 현재 선택된 존 스캔 목록에 없으면 (그룹 별칭) 추가 메시지가 표시됩니다.

이 그룹이 현재 선택된 존 스캔 목록에 이미 있으면 (그룹 별칭) 삭제 메시지가 표시됩니다.

9 을 눌러 표시된 메시지(추가 또는 삭제)를 수락합니다.

목록에서 그룹을 삭제하면 더하기 기호(+)가 별칭 바로 앞에 더 이상 표시되지 않으므로 작업이 성공했음을 알 수 있습니다.

목록에 그룹을 추가하면 더하기 기호(+)가 별칭 앞에 표시되므로 작업이 성공했음을 알 수 있습니다.

그룹을 추가하려고 할 때 목록이 이미 꽉 차있으면 무전기에 목록 가득참이 표시됩니다. 이런 경우에는 스캔 목록에서 그룹을 삭제한 후에 새 그룹을 추가해야 합니다.

- 10 완료되면 원하는 메뉴로 돌아갈 때까지  버튼을 누릅니다.

스캔 작업 이해



주의:

무전기가 다른 존에서 존 스캔 목록 멤버의 호출에 참가하고 호출 정지 타이머가 응답하기 전에 만료된 경우 응답하려면 스캔 목록 멤버의 존 및 채널을 탐색하고 새 호출을 시작해야 합니다.

스캔 목록에 있는 그룹에 대한 호출을 받지 못하는 경우가 있을 수 있습니다. 다음과 같은 이유 중 하나로 호출을 받지 못한 경우에는 무전기에 문제로 나타나지 않습니다. 이것은 **Connect Plus**의 정상적인 스캔 작동입니다.

- 스캔 기능이 꺼져 있습니다(디스플레이의 스캔 아이콘 확인).
- 메뉴를 통해 스캔 목록 멤버가 비활성화되었습니다([스캔 목록 편집 페이지의 241](#) 참조).
- 이미 호출에 참여하고 있습니다.

- 사이트에 등록된 스캔된 그룹의 멤버가 없습니다(멀티 사이트 시스템에만 해당).

토크백 스캔

무전기가 선택한 그룹 호출 목록에서 호출을 스캔하고 스캔한 호출 중에 **PTT** 버튼을 누른 경우 무전기의 작동은 무전기 프로그래밍 중에 토크백 스캔의 활성화 여부에 따라 달라집니다. 자세한 내용은 대리점이나 시스템 관리자에게 문의하십시오.

토크백 스캔 비활성화됨

무전기는 스캔한 호출을 그대로 두고 현재 선택한 채널 위치의 연락처에서 전송을 시도합니다. 현재 선택한 연락처에서 호출 정지 시간이 만료되면 무전기는 홈 채널로 돌아가고 스캔 정지 시간 타이머를 시작합니다. 무전기는 스캔 정지 시간 타이머가 만료되면 그룹 스캔을 다시 시작합니다.

토크백 스캔 활성화됨

스캔된 호출의 그룹 정지 시간 중에 **PTT** 버튼을 누르면 무전기가 스캔된 그룹으로의 전송을 시도합니다.



주의:

현재 선택한 존의 채널 위치에 할당되지 않은 그룹에 대한 호출을 스캔하지만 호출의 정지 시간 동안 호출을 받지 못한 경우 적절한 존으로 전환한 다음 해당 그룹에 회신할 채널 위치를 선택합니다.

통화 그룹의 우선 순위 편집

우선 순위 모니터링 기능을 사용하면 다른 호출을 받을 때 무전기가 자동으로 우선 순위가 높은 통화 그룹의 전송을 받을 수 있습니다. 무전기에서 우선 순위가 높은 호출로 전환될 때 신호음이 울립니다.



통화 그룹의 우선 순위 수준으로 P1과 P2가 있습니다. P1이 P2보다 우선 순위가 높습니다.









주의:



기본 비상 복원 그룹 ID가 MOTOTRBO Connect Plus Option Board CPS로 구성되어 있는 경우 통화 그룹의 우선 순위 수준에는 P0, P1 및 P2 세 가지가 있습니다. P0는 영구 비상 복원 그룹 ID이며 우선 순위가 가장 높습니다. 자세한 내용은 대리점이나 시스템 관리자에게 문의하십시오.



- 1  버튼을 눌러 메뉴로 이동합니다.

- 2  또는  을 눌러 스캔 및 선택하려면  버튼을 누릅니다.로 이동합니다.

- 3  또는  버튼을 눌러 목록 보기/편집으로 이동하고 선택하려면  버튼을 누릅니다..

- 4  또는  버튼을 눌러 원하는 통화 그룹으로 이동하고 선택하려면  버튼을 누릅니다..

- 5  또는  버튼을 눌러 우선 순위 편집으로 이동하고 선택하려면  버튼을 누릅니다..

- 6  또는  버튼을 눌러 원하는 우선 순위 레벨로 이동하고 선택하려면  버튼을 누릅니다.. 이전 화면으로 돌아가기 전에 디스플레이에 선택 미니 알림이 표시됩니다. 통화 그룹 왼쪽에 우선 순위 아이콘이 나타납니다.

연락처 설정



주의:

Connect Plus 연락처의 가입자 ID를 추가 또는 편집할 수 있습니다. 가입자 ID 삭제는 대리점에서만 수행할 수 있습니다.

채널에서 프라이버시 기능이 활성화된 경우 해당 채널에서 프라이버시가 활성화 음성 호출을 할 수 있습니다. 무전기와 동일한 프라이버시 키 또는 키 값과 키 ID를 가진 대상 무전기만 발신의 스크램블을 풀 수 있습니다.

연락처 목록에 대한 액세스는 구역 구성에 따라 달라집니다.

- 하나의 구역만 무전기에 구성된 경우 현재 선택된 구역의 목록만 연락처 목록에 바로 표시됩니다.
- 무전기에 여러 구역이 구성된 경우 구역 연락처 폴더는 현재 선택된 구역과 동일한 네트워크 ID를 가진 모든 구역을 표시합니다. 사용자는 이 구역의 연락처에 액세스할 수 있습니다.

연락처는 무전기에서 "주소록" 기능을 제공합니다. 각 항목은 호출을 시작하는 데 사용되는 별칭 또는 ID에 해당합니다.





각 존에서는 최대 100개의 연락처로 구성된 연락처 목록을 제공합니다. 다음 연락처 유형을 사용할 수 있습니다.

- 개별 호출

- 그룹 호출
- 다중 그룹 호출
- 사이트 모든 호출 음성
- 사이트 모든 호출 문자
- 발신 호출

디스패치 호출 연락처 유형은 타사 문자 메시지 서버를 사용하여 디스패치 PC에 문자 메시지를 보내는 데 사용됩니다.

연락처에서 개별 호출 전송

- 1  버튼을 눌러 메뉴에 액세스합니다.을 누릅니다.
- 2  또는  을 눌러 연락처 및 선택하려면  버튼을 누릅니다.로 이동합니다.
항목은 알파벳 순서대로 정렬되어 있습니다.
- 3 마이크를 2.5 ~ 5.0cm(1 ~ 2인치) 띄우고 듭니다.
- 4 **PTT** 버튼을 눌러 전화를 전송합니다.
녹색 LED가 켜집니다.

5 통화 허용 경보음(활성화된 경우)이 끝날 때까지 기다렸다가 마이크에 대고 명확히 말합니다.



6 상대방의 말을 들으려면 **PTT** 버튼을 놓습니다.

대상 무전기에서 응답하면 **LED**가 녹색으로 점멸하고 디스플레이에 발신 중인 사용자의 **ID**가 표시됩니다.

미리 정해진 시간 동안 음성 동작이 없으면 호출이 종료됩니다.

짧은 톤이 울립니다. 디스플레이에 통화 종료가 표시됩니다.

항목은 알파벳 순서대로 정렬되어 있습니다.

3 필요한 별칭의 첫 번째 문자를 입력한 다음  또는  버튼을 눌러 필요한 별칭을 찾습니다.

4 마이크를 2.5 ~ 5.0cm(1 ~ 2인치) 띄우고 듭니다.

5 **PTT** 버튼을 눌러 전화를 전송합니다.

녹색 **LED**가 켜집니다. 디스플레이에 대상 별칭이 표시됩니다.

6 통화 허용 경보음(활성화된 경우)이 끝날 때까지 기다렸다가 마이크에 대고 명확히 말합니다.

7 상대방의 말을 들으려면 **PTT** 버튼을 놓습니다.

대상 무전기에서 응답하면 **LED**가 녹색으로 깜박입니다.

미리 정해진 시간 동안 음성 동작이 없으면 호출이 종료됩니다.



디스플레이에 통화 종료가 표시됩니다.

별칭 검색으로 호출 전송

별칭이나 영숫자 검색을 사용하여 원하는 가입자 별칭을 검색할 수도 있습니다.



이 기능은 연락처에 있는 동안에만 사용할 수 있습니다.



1  버튼을 눌러 메뉴에 액세스합니다.을 누릅니다.

2  또는  을 눌러 연락처 및 선택하려면  버튼을 누릅니다.로 이동합니다.

새 연락처 추가



- 1  버튼을 눌러 메뉴에 액세스합니다.을 누릅니다.

- 2  또는  을 눌러 연락처 및 선택하려면  버튼을 누릅니다.로 이동합니다.

- 3  또는  버튼을 눌러 새 연락처로 이동하고 선택하려면  버튼을 누릅니다..

- 4 키패드로 연락처 번호를 입력한 다음  버튼을 눌러 확인합니다.

- 5 키패드로 연락처 이름을 입력한 다음  버튼을 눌러 확인합니다.

- 6 무전기 연락처를 추가하면  또는  버튼을 눌러 원하는 벨소리 유형으로 이동하고 선택하려면  버튼을 누릅니다..
무전기에서 선택음이 울리고 디스플레이에 연락처 저장 완료가 표시됩니다.



호출 표시 설정

이 기능을 사용하면 무전기 사용자가 호출 또는 문자 메시지 호출음을 구성할 수 있습니다.

호출 경보용 호출음 활성화 또는 비활성화

수신되는 호출 경보에 대한 호출음을 선택하거나 켜거나 끌 수 있습니다.

- 1  버튼을 눌러 메뉴에 액세스합니다.를 누릅니다.

- 2  또는  버튼을 눌러 유틸리티로 이동하고 선택하려면  버튼을 누릅니다..

3 ▲ 또는 ▼ 을 눌러 무전기 설정으로 이동하고
선택하려면  버튼을 누릅니다..

4 ▲ 또는 ▼ 을 눌러 톤/경보로 이동하고 선택하
려면  버튼을 누릅니다..

5 ▲ 또는 ▼ 을 눌러 호출음으로 이동하고 선택하
려면  버튼을 누릅니다..

6 ▲ 또는 ▼ 을 눌러 호출 경보로 이동하고 선택
하려면  버튼을 누릅니다..
현재 신호음은 ✓로 표시됩니다.

7 ▲ 또는 ▼ 을 눌러 원하는 톤으로 이동하고 선
택하려면  버튼을 누릅니다..
✓ 선택한 톤 옆에 가 표시됩니다.

개별 호출음 활성화 및 비활성화

수신되는 개별 호출에 대한 호출음을 켜거나 끌 수 있습니
다.



1  버튼을 눌러 메뉴에 액세스합니다.을 누릅니다.

2 ▲ 또는 ▼ 을 눌러 유틸리티 및 선택하려면
 버튼을 누릅니다.로 이동합니다.

3 ▲ 또는 ▼ 을 눌러 무전기 설정으로 이동하고
선택하려면  버튼을 누릅니다..

4 ▲ 또는 ▼ 버튼을 눌러 톤/경보 및 선택하려면
 버튼을 누릅니다.로 이동합니다.

5 ▲ 또는 ▼ 을 눌러 호출음으로 이동하고 선택하
려면  버튼을 누릅니다..

6  또는  버튼을 눌러 개별 호출로 이동하고 선택하려면  버튼을 누릅니다..

7  버튼을 눌러 개별 호출 경보음을 활성화하거나 비활성화합니다.



개별 호출 경보음이 활성화된 경우 디스플레이의 활성화됨 옆에 ✓가 표시됩니다.



개별 호출 경보음이 비활성화된 경우 ✓가 표시되지 않습니다.



문자 메시지용 호출음 활성화 및 비활성화



수신되는 문자 메시지에 대한 호출음을 켜거나 끌 수 있습니다.



1  버튼을 눌러 메뉴에 액세스합니다.을 누릅니다.



2  또는  을 눌러 유틸리티 및 선택하려면  버튼을 누릅니다.로 이동합니다.

3  또는  을 눌러 무전기 설정으로 이동하고 선택하려면  버튼을 누릅니다..

4  또는  버튼을 눌러 톤/경보 및 선택하려면  버튼을 누릅니다.로 이동합니다.

5  또는  을 눌러 호출음으로 이동하고 선택하려면  버튼을 누릅니다..

6  또는  버튼을 눌러 문자 메시지로 이동하고 선택하려면  버튼을 누릅니다.. 현재 신호음은 ✓로 표시됩니다.

7  또는  을 눌러 원하는 톤으로 이동하고 선택하려면  버튼을 누릅니다.. ✓선택한 톤 옆에 가 표시됩니다.

벨 경보 유형 선택



주의:

프로그래밍된 벨 경보 유형 버튼은 대리점이나 시스템 관리자에 의해 지정됩니다. 무전기가 프로그래밍된 방식에 대해서는 대리점이나 시스템 관리자에게 문의하십시오.

미리 정해진 진동 호출로 무전기 호출을 프로그래밍할 수 있습니다. 전체 톤 상태가 비활성화되어 있으면 무전기에 전체 톤 목록 아이콘이 표시되고, 전체 톤 상태가 활성화되어 있으면 관련된 벨 경보 유형이 표시됩니다.

일시적 벨소리 스타일인 경우에는 무전기가 한 번 진동합니다. 반복적 벨소리 스타일인 경우에는 무전기에서 진동이 반복적으로 울립니다. 진동 및 벨소리로 설정된 경우 수신 무전기 트랜잭션(예: 호출 경보, 메시지)이 있으면 무전기에서 특정 벨 신호음이 울립니다. 이 톤은 선택음이나 부재 중 호출과 같은 소리가 납니다.

알람음 볼륨 높이기

무전기 통화가 무응답 상태로 있는 경우 계속 사용자에게 정보로 알리도록 무전기를 프로그래밍할 수 있습니다. 알람음

이 울릴수록 볼륨이 자동으로 증가되도록 하면 됩니다. 이 기능을 커지는 정보음이라고 합니다.

호출 목록

무전기는 최근의 모든 발신, 응답 및 부재 중 개별 호출에 대한 기록을 보관합니다. 호출 목록 기능을 사용하면 최근 호출을 보고 관리할 수 있습니다.



각 호출 목록에서 다음 작업을 수행할 수 있습니다.



- 삭제
- 세부 항목 보기

최근 호출 목록 보기



목록에는 실패, 응답 및 발신 항목이 있습니다.

1  버튼을 눌러 메뉴에 액세스합니다.을 누릅니다.

2  또는  을 눌러 호출 목록으로 이동하고 선택하려면  버튼을 누릅니다..



3  또는  버튼을 눌러 원하는 목록으로 이동하고 선택하려면  버튼을 누릅니다..



디스플레이에 목록이 표시되며 최근 항목이 목록 맨 위에 나타납니다.

4  또는  버튼을 눌러 목록을 보냅니다.





현재 선택한 별칭이나 ID로 개별 호출을 시작하려면 **PTT** 버튼을 누릅니다.

항목이 없는 호출 목록을 선택할 경우 디스플레이에 목록 비어있음이 표시되고 키패드 톤이 켜져 있는 경우 톤이 작게 울립니다.

4  또는  버튼을 눌러 원하는 별칭 또는 ID로 이동하고 선택하려면  버튼을 누릅니다..



5  또는  버튼을 눌러 삭제 및 선택하려면  버튼을 누릅니다.로 이동합니다.



6 다음 중 하나를 수행합니다.

-  버튼을 눌러 예를 선택하고 항목을 삭제합니다. 디스플레이에 항목 삭제 완료가 표시됩니다.
-  또는  버튼을 눌러 아니요로 이동하고  버튼을 누릅니다. 버튼을 눌러 이전 화면으로 돌아갑니다.

호출 목록에서 호출 삭제



1  버튼을 눌러 메뉴에 액세스합니다.을 누릅니다.



2  또는  을 눌러 호출 목록으로 이동하고 선택하려면  버튼을 누릅니다..



3  또는  을 눌러 원하는 목록 및 선택하려면  버튼을 누릅니다.로 이동합니다.



호출 목록에서 세부 항목 보기

1  버튼을 눌러 메뉴에 액세스합니다.을 누릅니다.

2  또는  을 눌러 호출 목록으로 이동하고 선택하려면  버튼을 누릅니다..

3  또는  을 눌러 원하는 목록 및 선택하려면  버튼을 누릅니다.로 이동합니다.

4  또는  버튼을 눌러 원하는 별칭 또는 ID로 이동하고 선택하려면  버튼을 누릅니다..

5  또는  버튼을 눌러 세부 항목 보기로 이동하고 선택하려면  버튼을 누릅니다..
디스플레이에 호출 목록의 세부 항목이 표시됩니다.

호출 정보 작동

호출 정보 페이지 기능을 사용하면 가능할 경우 호출한 사용자에게 연락하도록 특정 무전기 사용자에게 경보를 보낼 수 있습니다.

이 기능은 연락처, 매뉴얼 다이얼 또는 프로그래밍된 원터치 액세스 버튼을 사용하여 메뉴를 통해 액세스할 수 있습니다.

호출 정보에 응답

다음 절차에 따라 무전기에서 호출 정보에 응답합니다.

호출 정보를 수신하는 경우:

- 반복음이 울립니다.
- 노란색 LED가 깜박입니다.
- 디스플레이에 발신 무전기의 별칭 또는 ID와 함께 호출 정보가 나열된 알람 목록이 표시됩니다.



대리점이나 시스템 관리자의 구성에 따라 다음 중 하나를 수행하여 호출 정보에 응답할 수 있습니다.

- **PTT** 버튼을 누르고 발신자에게 직접 개별 호출로 응답합니다.
- **PTT** 버튼을 눌러 정상적인 통화 그룹 통신을 계속합니다.
호출 정보가 호출 목록 메뉴에서 부재중 호출 옵션으로 이동합니다. 부재중 호출 목록에서 발신자에게 응답할 수 있습니다.

자세한 내용은 [알람 목록 페이지의 175](#) 및 [호출 목록 기능 페이지의 116](#) 부분을 참조하십시오.



연락처 목록에서 호출 경보 전송

1  버튼을 눌러 메뉴에 액세스합니다.을 누릅니다.



2  또는  을 눌러 연락처 및 선택하려면  버튼을 누릅니다.로 이동합니다.

3 다음에 설명한 단계 중 하나를 사용하여 원하는 가입자 별칭 또는 ID를 선택합니다.



- 가입자 별칭 직접 선택

-  또는  버튼을 눌러 원하는 가입자 별칭으로 이동하고 선택하려면  버튼을 누릅니다..

- 매뉴얼 다이얼 메뉴 사용

-  또는  버튼을 눌러 매뉴얼 다이얼로 이동하고 선택하려면  버튼을 누릅니다..

- 매뉴얼 다이얼 문자 입력 화면이 나타납니다. 가입자 ID를 입력하고  을 누릅니다.

4  또는  을 눌러 호출 경보로 이동하고 선택하려면  버튼을 누릅니다..

디스플레이에 호출 경보: <가입자 별칭 또는 ID> 호출 경보 및 가입자 별칭 또는 ID가 표시되어 호출 경보가 전송되었음을 나타냅니다.

무전기에서 호출 경보를 보낼 때 녹색 LED가 켜집니다.

호출 경보 승인이 수신되면 디스플레이에 호출 경보 성공이 표시됩니다.

호출 경보 승인이 수신되지 않으면 디스플레이에 호출 경보 실패가 표시됩니다.

원터치 액세스 버튼으로 호출 경보 전송

프로그래밍된 원터치 액세스 버튼을 눌러 미리 정의된 별칭에 호출 경보를 전송합니다.

디스플레이에 호출 경보와 가입자 별칭 또는 ID가 표시되어 호출 경보가 전송되었음을 나타냅니다.

무전기에서 호출 경보를 보낼 때 녹색 LED가 켜집니다.

호출 경고 승인이 수신되면 디스플레이에 호출 경고 성공이 표시됩니다.

호출 경고 승인이 수신되지 않으면 디스플레이에 호출 경고 실패가 표시됩니다.

프로그래밍된 **음소거 모드** 버튼을 사용하여 이 기능에 액세스합니다.

음소거 모드

음소거 모드는 사용자가 무전기의 모든 오디오 표시등의 음을 소거할 수 있는 옵션을 제공합니다.

음소거 모드 기능이 실행되면 비상 작동과 같은 우선순위가 높은 기능을 제외한 모든 오디오 표시등이 음소거됩니다.

음소거 모드가 종료되면 무전기가 진행 중인 신호음과 오디오 전송을 재개합니다.



주의:

이 기능은 유료입니다. 자세한 내용은 대리점이나 시스템 관리자에게 문의하십시오.

음소거 모드 켜기

다음 절차에 따라 음소거 모드를 켭니다.

음소거 모드가 활성화되면 다음이 발생합니다.



- 선택음이 울립니다.
- 디스플레이에 음소거 모드 켜기가 표시됩니다.
- 빨간색 LED가 깜박이기 시작하며 음소거 모드가 종료될 때까지 깜박입니다.
- 디스플레이의 홈 화면에 **음소거 모드** 아이콘이 표시됩니다.
- 무전기가 음소거됩니다.
- 구성된 기간 동안 음소거 모드 타이머가 카운트를 세기 시작합니다.



음소거 모드 타이머 설정



음소거 모드 기능은 음소거 모드 타이머의 시간을 미리 구성하여 활성화할 수 있습니다. 이 타이머는 무전기 메뉴에서 구성 가능하며 0.5-6시간 범주 내에서 설정할 수 있습니다. 타이머가 만료되면 음소거 모드도 종료됩니다.



타이머의 남은 시간이 0이면 미리 프로그래밍된 **음소거 모드** 버튼을 누를 때까지 음소거 상태를 무한 시간 동안 유지합니다.

- 1  버튼을 눌러 메뉴로 이동합니다.

- 2  또는  버튼을 눌러 유틸리티로 이동합니다.  버튼을 눌러 선택합니다.

- 3  또는  버튼을 눌러 무전기 설정으로 이동합니다.  버튼을 눌러 선택합니다.

- 4  또는  버튼을 눌러 음소거 타이머로 이동합니다.  버튼을 눌러 선택합니다.

- 5  또는  버튼을 눌러 다음 숫자 값을 수정한 뒤  버튼을 누릅니다.

음소거 모드 종료

이 기능은 음소거 모드 타이머가 만료되면 자동으로 종료할 수 있습니다.

다음 방법 중 한 가지를 사용하여 음소거 모드를 수동으로 종료합니다.

- 프로그래밍된 **음소거 모드** 버튼을 누릅니다.
- 아무 항목에서 **PTT** 버튼을 누릅니다.

음소거 모드가 비활성화되면 다음이 발생합니다.

- 해제음이 울립니다.
- 디스플레이에 음소거 모드 끄기가 표시됩니다.
- 점멸하는 빨간색 LED가 꺼집니다.
- **음소거 모드** 아이콘이 홈 화면에서 사라집니다.
- 무전기의 음소거가 해제되고 스피커 상태가 복구됩니다.
- 타이머가 만료되지 않으면 음소거 모드 타이머가 중단됩니다.



주의:

또한 사용자가 음성을 전송하거나 프로그래밍되지 않은 채널로 전환하면 음소거 모드가 종료됩니다.

비상 작동



주의:

무전기에 목음 또는 목음 및 음성 비상 시작이 프로그래밍되어 있는 경우 비상 호출이나 비상 경보가 완료되면 대부분 무전기가 자동으로 목음 작동을 종료합니다. 이 규칙의 예외는 비상 모드로 비상 경보가 구성되어 있고 비상 유형으로 목음이 구성된 경우입니다. 무전기가 이 상태로 구성되어 있으면 **PTT** 또는 비상 끄기용으로 구성된 버튼을 눌러 무음 작동을 취소할 때까지 무음 작동이 계속됩니다.

Connect Plus 자동 폴백 모드에서 작동할 때에는 비상 음성 호출 및 비상 경보가 지원되지 않습니다. 자세한 내용은 [자동 폴백 페이지의 235](#)을 참조하십시오.

비상 경보는 중요 상황을 나타내는 데 사용됩니다. 현재 채널에 활동이 있는 경우를 비롯하여, 아무 때나 모든 화면 디스플레이에서 비상 호출을 시작할 수 있습니다. **비상** 버튼을 눌러 프로그래밍된 비상 모드를 시작합니다. 선택 사항인 맨다운 기능을 사용하여 프로그래밍된 비상 모드를 시작할 수도 있습니다. 무전기의 비상 기능이 비활성화되어 있을 수 있습니다.

대리점에서 프로그래밍된 **비상** 버튼의 버튼 누름 지속 시간을 설정할 수 있습니다. 단, 다른 모든 버튼과 마찬가지로 길게 누르기는 제외입니다.

짧게 누르기

0.05초 ~ 0.75초.

길게 누르기

1.00초 ~ 3.75초.

비상 버튼은 비상 켜기/끄기 기능으로 지정됩니다. **비상** 버튼에 작동 지정은 대리점에 문의하십시오.

- **비상** 버튼을 짧게 누르면 비상 모드가 켜지도록 지정된 경우 **비상** 버튼을 길게 누르면 비상 모드가 종료됩니다.
- **비상** 버튼을 길게 누르면 비상 모드가 켜지도록 지정된 경우 **비상** 버튼을 짧게 누르면 비상 모드가 종료됩니다.

Connect Plus 존에서 무전기가 선택된 상태인 경우 무전기는 세 가지 비상 모드를 지원합니다.

비상 호출

PTT 버튼을 눌러 할당된 비상 시간 슬롯에서 호출해야 합니다.

비상 호출 포함 음성 알림:

할당된 비상 시간 슬롯의 첫 번째 전송인 경우 마이크가 자동으로 활성화되고 **PTT** 버튼을 누를 필요 없이 호출할 수 있습니다. 마이크가 무전기에 프로그래밍된 기간 동안 이 방식으로 "동작" 상태를 유지합니다. 동일한 비상 호출의 후속 전송인 경우에는 **PTT** 버튼을 눌러야 합니다.

비상 정보

비상 정보는 음성 호출이 아니라, 이 경보를 수신하도록 구성된 무전기에 전송되는 비상 통지입니다. 무전기에서는 현재 등록된 사이트의 컨트롤 채널을 통해 비상 경보를 전송합니다. **Connect Plus** 네트워크에서 이 비상 경보를 수신하도록 프로그래밍된 무전기는 어떤 네트워크 사이트에 등록되어 있더라도 비상 경보를 수신합니다.

존 하나당 비상 버튼에 비상 모드 중 하나만 할당할 수 있습니다. 또한 각 비상 모드에는 다음과 같은 유형이 있습니다.

일반

무전기가 비상 기능을 시작하고 상태 표시음 및/또는 표시등으로 이를 나타냅니다.

무음

무전기가 상태 표시음 또는 표시등 없이 비상 기능을 시작합니다. **PTT** 버튼을 눌러 음성 전송을 시작할 때까지 무전기에서 비상 기능의 모든 신호음이나 표시등이 억제됩니다.

무음 및 음성

무전기가 일부 음성 전송에 대해서도 음소거된다는 것을 제외하면, 무음과 동일하게 동작합니다.

들어오는 비상 수신

무전기가 경보음을 울리는 동시에 들어오는 비상에 대한 정보를 표시하도록 프로그래밍되어 있을 수 있습니다. 그럴 경

우 들어오는 비상을 수신하면 디스플레이에 비상 아이콘, 비상을 요청한 무전기의 별칭 또는 ID, 비상에 사용된 그룹 연락처, 하나의 추가 정보 줄이 포함된 비상 세부 정보 화면이 표시됩니다. 추가 정보는 그룹 연락처를 포함하는 존 이름입니다.

현재 무전기는 최근 디코딩된 비상 정보만 표시합니다. 이전 비상이 해제되기 전에 새 비상이 수신되면 새 비상의 세부 정보가 이전 비상의 세부 정보를 대체합니다.

무전기가 프로그래밍된 방식에 따라 비상이 종료된 후에도 비상 세부 정보 화면(또는 알람 목록 화면)이 무전기 디스플레이에 그대로 표시됩니다. 비상 세부 정보를 알람 목록에 저장하거나 다음 섹션에 설명된 대로 비상 세부 정보를 삭제할 수 있습니다.



알람 목록에 비상 세부 정보 저장

비상 세부 정보를 알람 목록에 저장하면 나중에 기본 메뉴에서 알람 목록을 선택하여 다시 세부 정보를 볼 수 있습니다.



- 1 비상 세부 정보(또는 알람 목록) 화면이 표시된 동안  버튼을 누릅니다.

알람 목록 종료 화면이 표시됩니다.

- 2 다음 작업 중 하나를 수행합니다.

- 예를 선택한 다음  버튼을 눌러 비상 세부 정보를 알람 목록에 저장하고 비상 세부 정보(또는 알람 목록) 화면을 종료합니다.
- **아니요**를 선택한 다음  버튼을 눌러 비상 세부 정보(또는 알람 목록) 화면으로 돌아갑니다.

비상 세부 정보 삭제

- 1 비상 세부 정보 화면이 표시되어 있는 동안  버튼을 누릅니다.
삭제 화면이 표시됩니다.
- 2 다음 작업 중 하나를 수행합니다.
 - 예를 선택하고  버튼을 눌러 비상 세부 정보를 삭제합니다.
 - **아니요**를 선택한 다음  버튼을 눌러 비상 세부 정보 화면으로 돌아갑니다.

비상 호출에 응답



주의:

비상 호출 정지 시간에 할당된 기간 내에 비상 호출에 응답하지 않으면 비상 호출이 종료됩니다. 비상 호출 정지 시간이 만료된 후 그룹과 통화하려면 우선 해당 그룹에 할당된 채널 위치를 선택해야 합니다(이미 선택되지 않은 경우). 그런 다음 **PTT**를 눌러 그룹에 비상이 아닌 호출을 시작합니다.

- 1 비상 호출을 수신하면 아무 버튼을 눌러 모든 비상 호출 수신 표시를 중지합니다.
- 2 **PTT** 버튼을 눌러 비상 그룹에 음성 전송을 시작합니다.
이 그룹을 모니터링하는 모든 무전기가 이 음성 전송을 듣게 됩니다.
- 3 통화 허용 경보음(활성화된 경우)이 끝날 때까지 기다렸다가 마이크에 대고 명확히 말합니다.
녹색 LED 표시가 켜집니다.

4 상대방의 말을 들으려면 **PTT** 버튼을 놓습니다.

비상을 시작한 무전기가 응답하면 녹색 **LED**가 깜박입니다. 디스플레이에 그룹 전화 아이콘, 그룹 **ID** 및 발신 중인 무전기 **ID**가 표시됩니다.

비상 복원 호출 무시를 활성화하려면 무전기가 **CPCPS(Connect Plus Customer Programming Software)**에서 구성되어야 합니다.

기능이 활성화되면 무전기에 비상 호출 표시가 표시되지 않으며 기본 비상 복원 그룹 **ID**에서 오디오가 수신되지 않습니다.

자세한 내용은 대리점이나 시스템 관리자에게 문의하십시오.

비상 경보에 응답



주의:

비상 경보에 사용된 그룹 연락처는 음성 통신에 사용할 수 없습니다. 그러면 동일한 그룹의 다른 무전기가 비상 경보를 전송 및 수신할 수 없습니다.

무전기의 비상 경보는 사용자가 비상한 상황에 있다는 의미입니다. 비상 상황을 선언한 발신자의 무전기와 개별 호출을 시작하거나, 지정된 통화 그룹과 그룹 호출을 시작하거나, 무전기에 호출 경보를 전송하거나, 해당 무전기와 원격 모니터를 시작하는 등의 방법으로 경보에 응답할 수 있습니다. 적절한 응답은 조직과 개별 상황에 따라 결정됩니다.

비상 복원 호출 무시

이 기능 향상은 무전기에게 활성화 비상 복원 호출을 무시할 수 있는 옵션을 제공합니다.

비상 호출 시작



주의:

무전기가 묵음으로 설정된 경우에는 비상 모드 중에도 **PTT** 버튼을 눌러 음성 전송을 시작할 때까지 아무 톤이나 표시가 나타나지 않습니다.

무전기가 묵음 및 음성으로 설정된 경우에는 무전기가 비상 모드라는 톤이나 표시가 나타나지 않다가 비상 호출에 회신하는 무전기 전송이 있으면 무전기 음소거가 해제됩니다. 무전기에서 **PTT** 버튼을 눌러 음성 전송을 시작한 경우에만 비상 톤이나 표시가 나타납니다.

"묵음" 및 "묵음 및 음성" 작동 모두에서 비상 호출이 완료되면 무전기가 자동으로 묵음 동작을 종료합니다.

1 프로그래밍된 **비상** 버튼을 누릅니다.

2 **PTT** 버튼을 눌러 비상 그룹에 음성 전송을 시작합니다.

PTT 버튼을 놓으면 비상 호출 정지 시간에 할당된 시간 동안 비상 호출이 지속됩니다.

이 기간 동안 **PTT** 버튼을 누르면 비상 호출이 계속됩니다.

지시 음성 포함 비상 호출 시작

무전기가 이 작동 유형으로 프로그래밍되어 있어야 합니다.

이 작동을 활성화한 경우 프로그래밍된 **비상** 버튼을 누르고 무전기가 시간 슬롯 할당을 받으면 **PTT** 버튼을 누르지 않아도 마이크가 자동으로 활성화됩니다. 이와 같이 활성화된 마이크 상태를 "핫 마이크"라고도 합니다. 비상 호출 중에 "핫 마이크"는 무전기의 첫 번째 음성 전송에 적용됩니다. 동일한 비상 호출의 후속 전송인 경우에는 **PTT** 버튼을 눌러야 합니다.

1 프로그래밍된 **비상** 버튼을 누릅니다.

2 무전기 코드플러그 프로그래밍에 지정된 "핫 마이크" 시간 동안 마이크가 활성 상태로 유지됩니다.

이 기간 동안에는 녹색 LED가 켜집니다.

3 프로그래밍된 기간보다 길게 말하려면 **PTT** 버튼을 계속 누릅니다.

비상 경보 시작



주의:

무전기가 "묵음" 또는 "묵음 및 음성"으로 프로그래밍된 경우에는 비상 경보를 전송하고 있다는 톤이나 표시가 나타나지 않습니다. "묵음"으로 프로그래밍된 경우에는 **PTT**나 "비상 끄기"용으로 구성된 버튼을 누를 때까지 묵음 작동이 지속됩니다. "묵음 및 음성"으로 프로그래밍된 경우에는 사이트 컨트롤러가 비상 경보를 브로드캐스트하기 시작하면 무전기가 자동으로 묵음 작동을 취소합니다.

주황색 **비상** 버튼을 누릅니다.

비상 경보를 사이트 컨트롤러에 송신하면 무전기 디스플레이에 비상 아이콘과 비상 경보 및 TX 알람에 사용된 그룹 연락처가 표시됩니다.

비상 경보가 성공적으로 전송되고 다른 무전기가 수신할 수 있도록 브로드캐스트되면 선택음이 울리고 무전기에 알람 전송이 표시됩니다. 비상 경보에 실패한 경우, 해제음이 울리고 무전기에 알람 실패가 표시됩니다.

비상 모드 종료



주의:

비상 호출 정지 시간이 만료되어 비상 호출이 종료되었지만 비상 상황이 해결되지 않은 경우 **비상** 버튼을 다시 눌러 프로세스를 다시 시작합니다.

프로그래밍된 **비상** 버튼을 눌러 비상 경보를 시작하는 경우 무전기가 **Connect Plus** 시스템에서 응답을 수신하면 비상 모드를 자동으로 종료합니다.

프로그래밍된 **비상** 버튼을 눌러 비상 호출을 시작하는 경우 사용 가능한 채널이 있으면 무전기에 자동으로 할당됩니다. 무전기가 비상 호출을 나타내는 메시지를 전송한 경우 비상 호출을 취소할 수 없습니다. 더 이상 비상 상황이 없을 때 실수로 이 버튼을 누른 경우 할당된 채널을 통해 이 사실을 알

릴 수 있습니다. 무전기의 **PTT** 버튼을 놓으면 비상 호출 정지 시간이 만료된 후 비상 호출이 중단됩니다.

무전기가 **비상 호출(후속 음성 포함)**으로 구성된 경우에는 **“핫 마이크”** 기간을 사용하여 실수를 설명하고 PTT 버튼을 놓아 전송을 중단합니다. 그러면 비상 호출 정지 시간이 만료된 후 비상 호출이 중단됩니다.

문자 메시지

이 무전기는 다른 무전기나 문자 메시지 응용 프로그램에서 문자 메시지와 같은 데이터를 수신할 수 있습니다.

DMR(Digital Mobile Radio) 단문 메시지 및 문자 메시지라는 두 가지 유형의 문자 메시지가 있습니다. **DMR** 단문 메시지의 최대 길이는 **23**자입니다. 문자 메시지의 최대 길이는 제목 줄을 포함하여 **280**자입니다. 제목 줄은 이메일 응용 프로그램에서 보낸 메시지를 받은 경우에만 나타납니다.



주의:

최대 문자 길이는 최신 소프트웨어 및 하드웨어 모델에만 해당합니다. 이전 소프트웨어 및 하드웨어가 있는 무전기 모델의 경우 문자 메시지의 최대 길이는 **140**자입니다. 자세한 내용은 대리점이나 시스템 관리자께 문의하십시오.



단축 문자 메시지 전송

무전기는 대리점에서 프로그래밍된 대로 최대 10개의 단축 문자 메시지를 지원합니다.

단축 문자 메시지를 미리 정의한 경우 전송하기 전에 각 메시지를 편집할 수 있습니다.

메시지를 보내는 경우 다음을 수행하여 수신자를 선택합니다.

- ▲ 또는 ▼ 버튼을 눌러 원하는 별칭으로 이동하고 선택하려면  버튼을 누릅니다..

- ▲ 또는 ▼ 버튼을 눌러 매뉴얼 다이얼로 이동하고 선택하려면  버튼을 누릅니다.. 디스플레이의 첫 번째 줄에 번호:가 표시됩니다. 디스플레이의 두 번째 줄에 커서가 깜박입니다. 가입자 별칭이나 ID를 입력하고  버튼을 누릅니다.

디스플레이에 메시지 보내기가 표시되어 메시지가 전송 중임을 나타냅니다.

메시지가 전송되면 톤이 울리고 디스플레이에 메시지 전송 완료가 표시됩니다.

메시지를 전송할 수 없는 경우에는 낮은 톤이 울립니다. 그리고 디스플레이에 메시지 전송 실패가 표시됩니다.

문자 메시지를 전송하지 못했으면 무전기가 재전송 옵션 화면으로 돌아갑니다([전송 실패 문자 메시지 관리 페이지의 266](#) 참조).

원터치 액세스 버튼을 사용하여 단축 문자 메시지 전송

대리점에서 프로그래밍 가능 버튼을 사용하여 단축 문자 메시지를 전송할 수 있습니다.

프로그래밍된 원터치 액세스 버튼을 눌러 미리 정의된 별칭에 미리 정의된 단축 문자 메시지를 전송합니다.

디스플레이에 메시지 보내기가 표시되어 메시지가 전송 중임을 나타냅니다.

메시지가 전송되면 톤이 울립니다. 그리고 디스플레이에 메시지 전송 완료가 표시됩니다.

메시지를 전송할 수 없는 경우에는 낮은 톤이 울립니다. 그리고 디스플레이에 메시지 전송 실패가 표시됩니다.

문자 메시지를 전송하지 못했으면 무전기가 재전송 옵션 화면으로 돌아갑니다(전송 실패 문자 메시지 관리 페이지의 266 참조).

임시보관함 폴더에 액세스

임시보관함 폴더에는 최근에 저장한 메시지가 최대 10개까지 저장됩니다. 폴더가 다 차면 다음에 저장한 문자 메시지가 폴더에서 가장 오래된 문자 메시지를 자동으로 대체합니다.



주의:

저장된 문자 메시지를 전송하기 전에 편집할 수 있습니다. 키패드 마이크를 사용해야만 가능합니다(저장된 문자 메시지 편집 및 전송 페이지의 265 참조). 홈

화면으로 돌아가려면 언제든지 버튼을 길게 누릅니다.

저장된 문자 메시지 보기

1 문자 메시지 기능에 액세스합니다.



무전기 컨트롤	단계
프로그래밍된 문자 메시지 버튼	프로그래밍된 문자 메시지 버튼을 누릅니다.
메뉴	<p>a 버튼을 눌러 메뉴에 액세스합니다.을 누릅니다.</p> <p>b 또는 버튼을 눌러 메시지 및 선택하려면 버튼을 누릅니다.로 이동합니다.</p>





2 또는 버튼을 눌러 임시 보관함 및 선택하려면 버튼을 누릅니다.로 이동합니다.

3 또는 을 눌러 원하는 메시지 및 선택하려면 버튼을 누릅니다.로 이동합니다.

저장된 문자 메시지 편집 및 전송







- 1 메시지를 보는 동안  버튼을 다시 한 번 누릅니다.

- 2  또는  버튼을 눌러 편집으로 이동하고 선택하려면  버튼을 누릅니다..
깜박이는 커서가 나타납니다.

- 3 키패드를 사용하여 메시지를 입력합니다.
왼쪽으로 한 칸 이동하려면  버튼을 누릅니다. 오른쪽으로 한 칸 이동하려면  또는  키를 누릅니다. 필요 없는 문자를 삭제하려면  키를 누릅니다. 문자 입력 방법을 변경하려면  버튼을 길게 누릅니다.

- 4 메시지를 작성했으면  버튼을 누릅니다.

- 5 다음 방법으로 메시지 받는 사람을 선택합니다.

-  또는  버튼을 눌러 원하는 별칭으로 이동하고 선택하려면  버튼을 누릅니다..
-  또는  버튼을 눌러 매뉴얼 다이얼로 이동하고 선택하려면  버튼을 누릅니다.. 디스플레이의 첫 번째 줄에 번호:가 표시됩니다. 디스플레이의 두 번째 줄에 커서가 깜박입니다. 가일자 별칭이나 ID를 입력하고  버튼을 누릅니다.

디스플레이에 메시지 보내기가 표시되어 메시지가 전송 중임을 나타냅니다.





메시지가 전송되면 톤이 울리고 디스플레이에 메시지 전송 완료가 표시됩니다.



메시지를 전송할 수 없는 경우에는 낮은 톤이 울립니다. 그리고 디스플레이에 메시지 전송 실패가 표시됩니다.



문자 메시지를 전송하지 못했으면 해당 메시지가 보낸 문자함 폴더로 이동되고 전송 실패 아이콘이 표시됩니다.



임시보관함에 저장된 문자 메시지 삭제

1 문자 메시지 기능에 액세스합니다.

무전기 컨트롤	단계
프로그래밍된 문자 메시지 버튼	프로그래밍된 문자 메시지 버튼을 누릅니다.
메뉴	<p>a  버튼을 눌러 메뉴에 액세스합니다.을 누릅니다.</p> <p>b  또는  버튼을 눌러 메시지 및 선택하려면  버튼을 누릅니다.로 이동합니다.</p>

2  또는  버튼을 눌러 임시 보관함 및 선택하려면  버튼을 누릅니다.로 이동합니다.

3  또는  을 눌러 원하는 메시지 및 선택하려면  버튼을 누릅니다.로 이동합니다.

4  또는  버튼을 눌러 삭제로 이동하고  버튼을 눌러 문자 메시지를 삭제합니다.

전송 실패 문자 메시지 관리

재전송 옵션 화면에서 다음 옵션 중 하나를 선택할 수 있습니다.

- 재전송
- 전달
- 편집

문자 메시지 재전송



 버튼을 눌러 동일한 메시지를 동일한 가입자/그룹 별칭 또는 ID로 재전송합니다.



메시지가 전송되면 톤이 울리고 디스플레이에 선택 미니 알림이 표시됩니다.

메시지를 전송할 수 없는 경우 디스플레이에 해제 미
니 알림이 표시됩니다.

문자 메시지 전달

전달을 선택하여 다른 가입자/그룹 별칭이나 ID로 메시지를
전송합니다.

1  또는  을 눌러 전달 및 선택하려면  버튼을 누릅니다.로 이동합니다.

2 메시지 받는 사람을 선택하려면  또는  버
튼을 눌러 원하는 별칭 또는 ID로 이동하고 선택하려
면  버튼을 누릅니다..

디스플레이에 메시지 보내기가 표시되어 메시지가 전송 중
임을 나타냅니다.

메시지가 전송되면 톤이 울리고 디스플레이에 메시지 전송
완료가 표시됩니다.

메시지를 전송할 수 없는 경우에는 낮은 톤이 울립니다. 그
리고 디스플레이에 메시지 전송 실패가 표시됩니다.

전송한 문자 메시지 관리

다른 무전기로 전송된 메시지는 보낸 문자함에 저장됩니다.
최근에 전송한 문자 메시지가 항상 보낸 문자함 목록 맨 위
에 추가됩니다.

보낸 문자함 폴더에는 최근에 전송한 메시지를 최대 30통 저
장할 수 있습니다. 폴더가 다 차면 다음에 전송한 문자 메시
지가 폴더에서 가장 오래된 문자 메시지를 자동으로 대체합
니다.







주의:



홈 화면으로 돌아가려면 언제든지  버튼을 길게
누릅니다.



전송한 문자 메시지 보기

1 문자 메시지 기능에 액세스합니다.

무전기 킥 트롤	단계
프로그래 밍된 문자 메시지 버 튼	프로그래밍된 문자 메시지 버튼을 누릅니다.

무전기 킷 트롤	단계
메뉴	<p>a  버튼을 눌러 메뉴에 액세스합니다.을 누릅니다.</p> <p>b  또는  버튼을 눌러 메시지 및 선택하려면  버튼을 누릅니다.로 이동합니다.</p>

2  또는  버튼을 눌러 보낸 문자함 및 선택하려면  버튼을 누릅니다.으로 이동합니다.

3  또는  버튼을 눌러 원하는 메시지로 이동하고 선택하려면  버튼을 누릅니다..



화면 맨 위의 오른쪽 모서리에 있는 아이콘은 메시지의 상태를 나타냅니다([보낸 문자함 아이콘 페이지의 216](#) 참조).

전송한 문자 메시지 전송

전송한 문자 메시지를 보는 동안 다음 옵션 중 하나를 선택할 수 있습니다.

- 재전송
- 전달
- 편집
- 삭제

1 메시지를 보는 동안  버튼을 다시 한 번 누릅니다.

2  또는  선택하려면  버튼을 누릅니다. 다음 중 하나로 이동하고.

옵션	단계
전달	다른 가입자/그룹 별칭이나 ID로 선택한 문자 메시지를 전송하려면 전달을 선택합니다(문자 메시지 전달 페이지의 267 참조).
삭제	문자 메시지를 삭제하려면 삭제를 선택합니다.

옵션	단계
재전송	<p>동일한 가입자/그룹 별칭이나 ID로 선택한 문자 메시지를 재전송하려면 재전송을 선택합니다.</p> <p>디스플레이에 메시지 보내기가 표시되어 동일한 메시지가 동일한 대상 무전기로 전송 중임을 나타냅니다.</p> <p>메시지가 전송되면 톤이 울리고 디스플레이에 메시지 전송 완료 표시됩니다.</p> <p>메시지를 전송할 수 없는 경우에는 낮은 톤이 울립니다. 그리고 디스플레이에 메시지 전송 실패가 표시됩니다.</p> <p>메시지를 전송하지 못했으면 무전기가 재전송 옵션 화면으로 돌아옵니다. [OK] 버튼을 눌러 메시지를 동일한 가입자/그룹 별칭 또는 ID로 재전송합니다.</p>

메시지를 전송하는 중에 메시지 전송 화면을 종료하면 신호음이나 표시등 없이 무전기는 보낸 문자함 폴더의 메시지 상태를 업데이트합니다.





보낸 문자함의 메시지 상태를 업데이트하기 전에 무전기 모드가 변경되거나 전원이 꺼지면 무전기에서 진행 중인 메시지를 완료할 수 없으며 메시지에 **전송 실패** 아이콘이 자동으로 표시됩니다.



무전기는 한 번에 최대 5개의 진행 중 메시지를 지원 합니다. 이 작업을 진행하는 안에는 무전기에서 새 메시지를 전송할 수 없으며 해당 새 메시지에 **전송 실패** 아이콘이 자동으로 표시됩니다.

보낸 문자함에서 전송한 모든 문자 메시지 삭제



1 문자 메시지 기능에 액세스합니다.

무전기 키프로 트를	단계
프로그래밍된 문자 메시지 버튼	프로그래밍된 문자 메시지 버튼을 누릅니다.







무전기 킨 단계 트롤	
메뉴	<p>a  버튼을 눌러 메뉴에 액세스합니다.을 누릅니다.</p> <p>b  또는  버튼을 눌러 메시지 및 선택하려면  버튼을 누릅니다.로 이동합니다.</p>

- 2  또는  버튼을 눌러 보낸 문자함 및 선택하려면  버튼을 누릅니다.으로 이동합니다.

문자 메시지가 없는 보낸 문자함을 선택할 경우 디스플레이에 목록 비었음이 표시되고 키패드 톤 켜져 있는 경우 톤이 작게 울립니다.

- 3  또는  버튼을 눌러 모두 삭제 및 선택하려면  버튼을 누릅니다.로 이동합니다.

- 4 다음 중 하나를 선택합니다.

-  또는  버튼을 눌러 예로 이동하고 선택하려면  버튼을 누릅니다.. 디스플레이에 선택 미니 알림이 표시됩니다.
-  또는  를 눌러 아니요로 이동한 다음  를 눌러 이전 화면으로 돌아갑니다.



문자 메시지 수신

무전기에서 메시지 수신 중에는 디스플레이에 발신자의 별칭 또는 ID가 있는 알림 목록과 메시지 아이콘이 표시됩니다.

문자 메시지 수신 시 다음 옵션 중 하나를 선택할 수 있습니다.

- Read
- 나중에 읽기
- 삭제



문자 메시지 읽기

- 1  또는  버튼을 눌러 읽기? 및 선택하려면

 버튼을 누릅니다.로 이동합니다.

수신 문자함에 선택한 메시지가 열립니다.

- 2 다음 중 하나를 수행합니다.

- 수신 문자함으로 돌아가려면  버튼을 누릅니다.
- 문자 메시지를 회신, 전달 또는 삭제하려면  버튼을 누 번 누릅니다.

수신된 문자 메시지 관리

수신 문자함을 사용하여 문자 메시지를 관리합니다. 수신 문자함은 최대 30통의 메시지를 저장할 수 있습니다.

수신 문자함의 문자 메시지는 최근에 수신된 순서대로 정렬됩니다.

무전기는 문자 메시지에 대해 다음 옵션을 지원합니다.

- 회신(단축 문자를 통해)

- 전달
- 삭제
- 전체 삭제







주의:



채널 유형이 일치하지 않으면 수신된 모든 메시지를 전달, 삭제 또는 모두 삭제만 가능합니다.



홈 화면으로 돌아가려면 언제든지  버튼을 길게 누릅니다.

수신 문자함의 문자 메시지 보기



- 1  버튼을 눌러 메뉴에 액세스합니다.을 누릅니다.

- 2  또는  버튼을 눌러 메시지 및 선택하려면  버튼을 누릅니다.로 이동합니다.

- 3  또는  버튼을 눌러 수신 문자함 및 선택하려면  버튼을 누릅니다.로 이동합니다.

- 4  또는  버튼을 눌러 메시지를 봅니다.



5 다음 중 하나를 수행합니다.



-  버튼을 눌러 현재 메시지를 선택한 다음  버튼을 다시 눌러 해당 메시지를 회신, 전달 또는 삭제합니다.
- 홈 화면으로 돌아가려면  버튼을 길게 누릅니다.



수신 문자함의 문자 메시지 회신

1 문자 메시지 기능에 액세스합니다.

무전기 킨 단계 트를	
프로그래밍된 문자 메시지 버튼	프로그래밍된 문자 메시지 버튼을 누릅니다.
메뉴	a  버튼을 눌러 메뉴에 액세스합니다.을 누릅니다.

무전기 킨 단계 트를	
	b  또는  버튼을 눌러 메시지 및 선택하려면  버튼을 누릅니다.로 이동합니다.

2  또는  버튼을 눌러 수신 문자함 및 선택하려면  버튼을 누릅니다.로 이동합니다.

3  또는  을 눌러 원하는 메시지 및 선택하려면  버튼을 누릅니다.로 이동합니다.

4  버튼을 한 번 더 눌러 하위 메뉴로 이동합니다.

5 키패드를 사용하여 메시지를 쓰고 편집합니다.

6 메시지를 작성했다면  버튼을 누릅니다. 디스플레이에 메시지 보내기가 표시되어 메시지가 전송 중임을 나타냅니다.

메시지가 전송되면 톤이 울리고 디스플레이에 메시지 완료가 표시됩니다.

메시지를 전송할 수 없는 경우에는 낮은 톤이 울립니다. 그리고 디스플레이에 메시지 전송 실패가 표시됩니다.



메시지를 보낼 수 없으면 무전기가 재전송 옵션 화면으로 돌아갑니다(전송 실패 문자 메시지 관리 페이지의 266 참조).



수신 문자함의 문자 메시지 삭제



1 문자 메시지 기능에 액세스합니다.

무전기 킷 단계 트롤	
프로그래밍된 문자 메시지 버튼	프로그래밍된 문자 메시지 버튼을 누릅니다.
메뉴	a  버튼을 눌러 메뉴에 액세스합니다.을 누릅니다.



무전기 킷 단계 트롤



b  또는  버튼을 눌러 메시지 및 선택하려면  버튼을 누릅니다.로 이동합니다.

2  또는  버튼을 눌러 수신 문자함 및 선택하려면  버튼을 누릅니다.로 이동합니다.

3  또는  을 눌러 원하는 메시지 및 선택하려면  버튼을 누릅니다.로 이동합니다.

4  버튼을 한 번 더 눌러 하위 메뉴로 이동합니다.





5  또는  버튼을 눌러 삭제 및 선택하려면  버튼을 누릅니다.로 이동합니다.



- 6  또는  버튼을 눌러 예로 이동하고  선택합니다.

디스플레이에 메시지 삭제 완료가 표시되고 화면은 수신 문자함으로 돌아갑니다.



수신 문자함의 모든 문자 메시지 삭제



- 1 문자 메시지 기능에 액세스합니다.

무전기 킷 트롤	단계
프로그래밍된 문자 메시지 버튼	프로그래밍된 문자 메시지 버튼을 누릅니다.
메뉴	<p>a  버튼을 눌러 메뉴에 액세스합니다.을 누릅니다.</p> <p>b  또는  버튼을 눌러 메시지 및 선택하려면  버튼을 누릅니다.로 이동합니다.</p>

- 2  또는  버튼을 눌러 수신 문자함 및 선택하려면  버튼을 누릅니다.로 이동합니다.

문자 메시지가 없는 수신 문자함을 선택할 경우 디스플레이에 목록 비었음이 표시됩니다. 그리고 키패드 신호음이 켜져 있는 경우 신호음이 작게 울립니다([키패드 톤 켜기 또는 끄기 페이지의 189](#) 참조).

- 3  또는  버튼을 눌러 모두 삭제 및 선택하려면  버튼을 누릅니다.로 이동합니다.

- 4  또는  버튼을 눌러 예로 이동하고  버튼을 눌러 선택합니다.
디스플레이에 수신 문자함 비우기가 표시됩니다.

개인 정보 보호

이 기능이 활성화된 경우 무단 사용자가 소프트웨어 기반 스크램블링 솔루션을 사용하여 채널에서 도청하는 것을 방지할 수 있습니다. 전송에 대한 신호 및 사용자 ID 부분은 스크램블링되지 않습니다.

프라이버시 활성화 발신을 보내려면 무전기가 현재 채널 선택기 위치에서 프라이버시가 활성화되어 있어야 하지만, 발신을 수신하기 위한 필수 사항은 아닙니다. 프라이버시 활성화 채널 선택기 위치에서는 무전기가 여전히 깨끗한(스크램블링되지 않은) 발신을 수신할 수 있습니다.

무전기는 고급 프라이버시를 지원합니다.

프라이버시 활성화 호출 전송의 스크램블을 풀려면 발신 무전기와 동일한 키 값과 키 ID를 사용하도록 무전기를 프로그래밍해야 합니다.

무전기에서 다른 키 값과 키 ID를 사용한 스크램블링된 호출을 받는 경우에는 아무것도 들리지 않습니다(고급 프라이버시).

무전기에 프라이버시 유형이 할당된 경우 홈 화면에 보안 또는 비보안 아이콘이 표시됩니다. 단, 무전기가 비상 호출이나 비상 알람을 송/수신 중인 경우에는 표시되지 않습니다.

무전기가 발신 중인 동안에는 LED가 녹색으로 켜지고 무전기가 진행 중인 프라이버시 활성화 발신을 수신 중일 때는 LED가 녹색으로 빠르게 깜박입니다.

다음 작업 중 하나를 통해 이 기능에 액세스할 수 있습니다.



- 프로그래밍된 **프라이버시** 버튼을 눌러 프라이버시를 켜거나 끕니다.
- 다음에 설명한 단계에 따라 무전기 메뉴를 사용합니다.









주의:

일부 무전기 모델에는 이러한 프라이버시 기능이 없을 수 있습니다. 자세한 내용은 대리점이나 시스템 관리자에게 문의하십시오.

1  버튼을 눌러 메뉴에 액세스합니다.을 누릅니다.

2  또는  을 눌러 유틸리티 및 선택하려면  버튼을 누릅니다.로 이동합니다.

3  또는  버튼을 눌러 무전기 설정으로 이동하거나  또는  버튼을 눌러 Connect Plus 로 이동하고 선택하려면  버튼을 누릅니다..

4  또는  버튼을 눌러 고급 프라이버시로 이동합니다.

디스플레이에 켜기가 표시되면  버튼을 눌러 프라이버시를 활성화합니다. 선택을 확인하는 메시지가 무전기에 표시됩니다.

디스플레이에 끄기가 표시되면  버튼을 눌러 프 라이버시를 비활성화합니다. 선택을 확인하는 메시지가 무전기에 표시됩니다.

무전기에 프 라이버시 유형이 할당된 경우 상태 표시 줄에 보안 또는 비보안 아이콘이 표시됩니다. 단, 무 전기가 비상 경보를 송/수신 중인 경우에는 표시되지 않습니다.

무단 사용을 방지하고 무전기를 회수하면 활성화할 수 있습니다.



주의:
무전기 폐쇄 또는 복구는 해당 기능이 활성화된 무전 기에서만 수행할 수 있습니다. 자세한 내용은 대리점 이나 시스템 관리자에게 문의하십시오.

무전기 비활성화



프라이버시 활성화(스크램블링된) 호출 전송

프로그래밍된 프라이버시 버튼을 사용하거나 메뉴를 사용하여 프라이버시 기능을 켭니다. 프라이버시 활성화하려면 무전기에 현재 선택된 채널 위치에 프라이버시 기능이 활성화 되어 있어야 합니다. 현재 선택된 채널 위치에 프라이버시 기능이 활성화되어 있으면 무전기에서 전송하는 모든 음성 이 스크램블링됩니다. 여기에는 그룹 호출, 다중 그룹 호출, 스캔 호출 중의 회신, 사이트 전체 호출, 비상 호출 및 개별 호출이 포함됩니다. 무전기와 동일한 키 값과 키 ID를 가진 수신 무전기만 발신의 스크램블을 풀 수 있습니다.

보안







시스템의 무전기를 활성화하거나 비활성화할 수 있습니다. 예를 들어 무전기를 도난 당한 경우 비활성화하여 무전기의

- 1 다음 작업 중 하나를 수행하여 이 기능에 액세스할 수 있습니다.







무전기 킨 트롤	단계
무전기 폐쇄 버튼	<p>a 프로그래밍된 무전기 비활성화 버튼을 누릅니다.</p> <p>b  또는  버튼을 눌러 원하는 별칭 또는 ID로 이동하고 선택하려면  버튼을 누릅니다..</p>



무전기 킷 단계
트롤

무전기 메뉴

- a**  버튼을 눌러 메뉴에 액세스합니다.을 누릅니다.
- b**  또는  을 눌러 연락처 및 선택하려면  버튼을 누릅니다.로 이동합니다. 항목은 알파벳 순서대로 정렬되어 있습니다.
- c** 다음에 설명한 단계 중 하나를 사용하여 원하는 가입자 별칭 또는 ID를 선택합니다.
- 원하는 별칭 또는 ID를 직접 선택합니다.
 -  또는  버튼을 눌러 원하는 별칭 또는 ID로 이동하고 선택하려면  버튼을 누릅니다..
 - 매뉴얼 다이얼 메뉴를 사용합니다.

무전기 킷 단계
트롤

-  또는  버튼을 눌러 매뉴얼 다이얼로 이동하고 선택하려면  버튼을 누릅니다..
-  또는  버튼을 눌러 무전기 번호로 이동하고 선택하려면  버튼을 누릅니다..
- 디스플레이의 첫 번째 줄에 무전기 번호:가 표시되고, 디스플레이의 두 번째 줄에 커서가 깜박입니다. 키패드를 사용하여 가입자 별칭이나 ID를 입력하고  버튼을 누릅니다.

무전기 킷 트롤	단계
	<p>d  또는  버튼을 눌러 무전기 비활성화로 이동하고 선택하려면  버튼을 누릅니다..</p>

디스플레이에 무전기 비활성화: <대상 별칭 또는 ID>가 표시되고 LED가 녹색으로 깜박입니다.







2 승인을 기다립니다.

성공하면 선택음이 울리고 디스플레이에 무전기 폐쇄 성공이 표시됩니다.

실패하면 해제음이 울리고 디스플레이에 무전기 폐쇄 실패가 표시됩니다.



무전기 복구

- 1** 다음 작업 중 하나를 수행하여 이 기능에 액세스할 수 있습니다.

무전기 킷 트롤	단계
무전기 복구 버튼	<p>a 프로그래밍된 무전기 활성화 버튼을 누릅니다.</p> <p>b  또는  버튼을 눌러 원하는 별칭 또는 ID로 이동하고 선택하려면  버튼을 누릅니다..</p>
무전기 메뉴	<p>a  버튼을 눌러 메뉴에 액세스합니다. 버튼을 누릅니다.</p> <p>b  또는  버튼을 눌러 연락처 및 선택하려면  버튼을 누릅니다.로 이동합니다. 항목은 알파벳 순서대로 정렬되어 있습니다.</p> <p>c 다음에 설명한 단계 중 하나를 사용하여 원하는 가입자 별칭 또는 ID를 선택합니다.</p>



무전기
컨트롤

단계

- 원하는 별칭 또는 ID를 직접 선택합니다.
- ▲ 또는 ▼ 버튼을 눌러 원하는 별칭 또는 ID로 이동하고 선택하려면  버튼을 누릅니다..
- 매뉴얼 다이얼 메뉴를 사용합니다.
- ▲ 또는 ▼ 버튼을 눌러 매뉴얼 다이얼로 이동하고 선택하려면  버튼을 누릅니다..
- ▲ 또는 ▼ 버튼을 눌러 무전기 번호로 이동하고 선택

무전기
컨트롤

단계

- 하려면  버튼을 누릅니다..
- 디스플레이의 첫 번째 줄에 무전기 번호:가 표시되고, 디스플레이의 두 번째 줄에 커서가 깜박입니다. 키패드를 사용하여 가입자 별칭이나 ID를 입력하고  버튼을 누릅니다.
- d ▲ 또는 ▼ 버튼을 눌러 무전기 활성화로 이동하고 선택하려면  버튼을 누릅니다..

디스플레이에 무전기 활성화: <가입자 별칭 또는 ID>가 표시되고 LED가 녹색으로 켜집니다.

2 승인을 기다립니다.

성공하면 선택음이 울리고 디스플레이에 무전기 복구 성공이 표시됩니다.

실패하면 해제음이 울리고 디스플레이에 무전기 복구 실패가 표시됩니다.

끗한 오디오 수신을 재설정합니다. 무전기의 Bluetooth 기능은 10미터 범위에서 최대 2.5mW(4dBm)로 작동합니다.

무전기는 다른 유형의 Bluetooth 사용 장치와의 Bluetooth 연결을 동시에 4개까지 지원할 수 있습니다. 헤드셋 및 POD(PTT-Only Device)를 예로 들 수 있습니다. 동일한 유형의 Bluetooth 장치와의 복수 연결은 지원되지 않습니다.

Bluetooth 사용 장치의 전체 기능에 대한 자세한 내용은 해당 Bluetooth 사용 장치의 사용자 설명서를 참조하십시오.

Bluetooth 작동



주의:

CPS를 통해 비활성화된 경우 모든 Bluetooth 관련 기능이 비활성화되고 Bluetooth 장치 데이터베이스가 지워집니다.

이 기능을 사용하면 무선 Bluetooth 연결을 통해 무전기를 Bluetooth 사용 장치(액세서리)와 함께 사용할 수 있습니다. 이 무전기는 Motorola Solutions 및 Commercially available Off-The-Shelf(COTS) Bluetooth 사용 장치를 모두 지원합니다.



Bluetooth는 시야 10미터(32피트) 범위 내에서 작동합니다. 이 범위 내에 있어야 무전기와 Bluetooth 사용 장치 간에 장애 없이 통신이 이루어집니다.



무전기와 Bluetooth 사용 장치를 분리한 경우 무전기를 뒤에도 Bluetooth 사용 장치가 높은 신뢰도로 작동할 것을 기대할 수는 없습니다.

수신 주변 영역에서는 음성과 경보음 품질이 모두 "왜곡되거나" "끊겨서" 들리기 시작합니다. 이 문제를 해결하려면 무전기와 Bluetooth 사용 장치를 가까이(10미터 내) 배치하여 깨

블루투스 켜기 및 끄기









1  버튼을 눌러 메뉴에 액세스합니다.을 누릅니다.

2  또는  을 눌러 Bluetooth 및 선택하려면  버튼을 누릅니다.로 이동합니다.

3  또는  을 눌러 나의 상태 및 선택하려면  버튼을 누릅니다.로 이동합니다.

디스플레이에 켜기와 끄기가 표시됩니다. 현재 상태는 로 표시됩니다.

4 다음 중 하나를 수행합니다.



-  또는  을 눌러 켜기 및 선택하려면  버튼을 누릅니다.로 이동합니다. 디스플레이에 켜기가 나타나고 선택한 상태 옆에 가 표시됩니다.
-  또는  을 눌러 끄기 및 선택하려면  버튼을 누릅니다.로 이동합니다. 디스플레이에 끄기가 나타나고 선택한 상태 옆에 가 표시됩니다.



Bluetooth 장치 찾기 및 연결

찾기 및 연결 작업 중 Bluetooth 사용 장치를 끄면 (또는









 버튼을 누름) 작업이 취소됩니다.



- 1 Bluetooth 사용 장치를 켜고 페어링 모드로 설정합니다. 해당 Bluetooth 사용 장치 사용자 설명서를 참조하십시오.
- 2 무전기에서  버튼을 눌러 메뉴에 액세스합니다.을 누릅니다.

- 3  또는  을 눌러 Bluetooth 및 선택하려면  버튼을 누릅니다.로 이동합니다.

- 4  또는  을 눌러 장치 및 선택하려면  버튼을 누릅니다.로 이동합니다.

5 다음 중 하나를 수행합니다.

-  또는  을 눌러 원하는 장치 및 선택하려면  버튼을 누릅니다.로 이동합니다.
-  또는  을 눌러 장치 찾기로 이동하여 사용 가능한 장치를 찾습니다.  또는  을 눌러 원하는 장치 및 선택하려면  버튼을 누릅니다.로 이동합니다.

- 6  또는  을 눌러 연결 및 선택하려면  버튼을 누릅니다.로 이동합니다. 디스플레이에 <장치>에 연결 중이 표시됩니다. Bluetooth 사용 장치에서 페어링을 완료하려면 추가

단계를 수행해야 할 수 있습니다. 해당 Bluetooth 사용 장치 사용자 설명서를 참조하십시오.

성공하면 무전기 디스플레이에 <장치> 연결 완료가 표시됩니다. 그러면 신호음이 울리고 연결된 장치 옆에 ✓가 나타납니다. 상태 표시줄에 Bluetooth 연결됨 아이콘이 나타납니다.

실패하면 무전기 디스플레이에 연결 실패가 표시됩니다.



Bluetooth 장치 찾기 및 연결(검색 가능 모드)



찾기 및 연결 작업 중 Bluetooth 또는 무전기를 끄면 작업이 취소되므로 주의하십시오.

1 Bluetooth를 켭니다.

블루투스 켜기 및 끄기 페이지의 280을 참조하십시오.

2  버튼을 눌러 메뉴에 액세스합니다.을 누릅니다.

3  또는  을 눌러 Bluetooth 및 선택하려면  버튼을 누릅니다.로 이동합니다.

4  또는  을 눌러 나의 장치 찾기 및 선택하려면  버튼을 누릅니다.로 이동합니다.



이제 프로그래밍된 지속 시간 동안 다른 Bluetooth 사용 장치가 사용자의 무전기를 검색할 수 있습니다. 이를 검색 가능 모드라고 합니다.



5 Bluetooth 사용 장치를 켜 다음 사용자의 무전기와 페어링합니다.



해당 Bluetooth 사용 장치 사용자 설명서를 참조하십시오.



Bluetooth 장치 연결 해제

1 무전기에서  버튼을 눌러 메뉴에 액세스합니다.을 누릅니다.

2  또는  을 눌러 Bluetooth 및 선택하려면  버튼을 누릅니다.로 이동합니다.

3  또는  을 눌러 장치 및 선택하려면  버튼을 누릅니다.로 이동합니다.

4  또는  을 눌러 원하는 장치 및 선택하려면  버튼을 누릅니다.로 이동합니다.

5  또는  버튼을 눌러 연결 해제 및 선택하려면  버튼을 누릅니다.로 이동합니다.

디스플레이에 <장치> 연결 끊는 중이 표시됩니다. Bluetooth 사용 장치에서 연결을 끊으려면 추가 단계를 수행해야 할 수 있습니다. 해당 Bluetooth 사용 장치 사용자 설명서를 참조하십시오.

무전기 디스플레이에 <장치> 연결 끊김이 표시됩니다. 선택음이 울립니다. 그리고 연결된 장치 옆에서 ✓가 사라집니다. 상태 표시줄에서 Bluetooth 연결 완료 아이콘이 사라집니다.

무전기 내부 스피커와 블루투스 장치 간에 오디오 라우팅 전환



무전기 내부 스피커와 외부 블루투스 사용 액세서리 간에 오디오 라우팅을 전환할 수 있습니다.



프로그래밍된 블루투스 오디오 스위치 버튼을 누릅니다.



- 경보음이 울리고 디스플레이에 무전기로 오디오 내보내기가 표시됩니다.
- 경보음이 울리고 디스플레이에 블루투스로 오디오 내보내기가 표시됩니다.



장치 세부 항목 보기

1  버튼을 눌러 메뉴에 액세스합니다.을 누릅니다.

2  또는  을 눌러 Bluetooth 및 선택하려면  버튼을 누릅니다.로 이동합니다.

3  또는  을 눌러 장치 및 선택하려면  버튼을 누릅니다.로 이동합니다.



4  또는  을 눌러 원하는 장치 및 선택하려면  버튼을 누릅니다.로 이동합니다.



5  또는  버튼을 눌러 세부 항목 보기로 이동하고 선택하려면  버튼을 누릅니다..



장치 이름 삭제



분리된 장치를 블루투스 사용 장치 목록에서 제거할 수 있습니다.

1  버튼을 눌러 메뉴에 액세스합니다.을 누릅니다.

2  또는  을 눌러 Bluetooth 및 선택하려면  버튼을 누릅니다.로 이동합니다.

3  또는  을 눌러 장치 및 선택하려면  버튼을 누릅니다.로 이동합니다.



4  또는  을 눌러 원하는 장치 및 선택하려면  버튼을 누릅니다.로 이동합니다.



5  또는  버튼을 눌러 삭제 및 선택하려면  버튼을 누릅니다.로 이동합니다.
디스플레이에 장치 삭제 완료가 표시됩니다.



Bluetooth 마이크 게인

연결된 Bluetooth 사용 장치 마이크 게인 값을 제어할 수 있습니다.



1  버튼을 눌러 메뉴에 액세스합니다.을 누릅니다.

2  또는  을 눌러 Bluetooth 및 선택하려면  버튼을 누릅니다.로 이동합니다.

3  또는  버튼을 눌러 Bluetooth 마이크 개인 및 선택하려면  버튼을 누릅니다.로 이동합니다.

4  또는  버튼을 눌러 Bluetooth 마이크 개인 유형 및 현재 값으로 이동합니다.

값을 편집하려면 선택하려면  버튼을 누릅니다..

5  또는  버튼을 눌러 값을 증가하거나 감소 시킨 다음 선택하려면  버튼을 누릅니다..

실내 위치











주의:

실내 위치 기능은 최신 소프트웨어 및 하드웨어와 모델에만 적용됩니다. 자세한 내용은 대리점이나 시스템 관리자에게 문의하십시오.

실내 위치는 무전기 사용자의 위치를 추적하는 데 사용됩니다. 실내 위치가 활성화되면 무전기가 제한된 검색 가능 모드가 됩니다. 무전기를 찾아 해당 위치를 확인할 전용 비콘이 사용됩니다.

실내 위치 켜기 또는 끄기

다음 작업 중 하나를 수행하여 실내 위치를 켜거나 끌 수 있습니다.

- 메뉴를 통해 이 기능에 액세스합니다.
 - a.  버튼을 눌러 메뉴에 액세스합니다. 버튼을 누릅니다.
 - b.  또는  을 눌러 Bluetooth 및 선택하려면  버튼을 누릅니다.로 이동합니다.
 - c.  또는  을 눌러 실내 위치 및 선택하려면  버튼을 누릅니다.로 이동합니다.
 - d.  을 눌러 실내 위치를 켭니다.

디스플레이에 실내 위치 켜기가 표시됩니다. 선택음이 들립니다. 다음 시나리오 중 하나가 발생합니다.

- 성공할 경우, 홈 화면 디스플레이에 실내 위치 사용 가능 아이콘이 나타납니다.
- 실패하는 경우, 디스플레이에 켜기 실패가 표시됩니다. 해제음이 들립니다.

- e.  을 눌러 실내 위치를 끕니다.

디스플레이에 실내 위치 끄기가 표시됩니다. 선택음이 들립니다.

다음 시나리오 중 하나가 발생합니다.

- 성공할 경우, 홈 화면 디스플레이에서 실내 위치 사용 가능 아이콘이 사라집니다.
- 실패하는 경우, 디스플레이에 끄기 실패가 표시됩니다. 해제음이 들립니다.

- 프로그래밍된 버튼을 사용하여 이 기능에 액세스합니다.

- a. 프로그래밍된 **실내 위치** 버튼을 길게 눌러 실내 위치를 켭니다.

디스플레이에 실내 위치 켜기가 표시됩니다. 선택음이 들립니다.

다음 시나리오 중 하나가 발생합니다.

- 성공할 경우, 홈 화면 디스플레이에 실내 위치 사용 가능 아이콘이 나타납니다.
- 실패하는 경우, 디스플레이에 켜기 실패가 표시됩니다. 실패하는 경우, 해제음이 들립니다.

- b. 프로그래밍된 **실내 위치** 버튼을 눌러 실내 위치를 끕니다.

디스플레이에 실내 위치 끄기가 표시됩니다. 선택음이 들립니다.



다음 시나리오 중 하나가 발생합니다.



- 성공할 경우, 홈 화면 디스플레이에서 실내 위치 사용 가능 아이콘이 사라집니다.
- 실패하는 경우, 디스플레이에 끄기 실패가 표시됩니다. 실패하는 경우, 해제음이 들립니다.



실내 위치 비콘 정보에 액세스

다음 절차에 따라 실내 위치 비콘 정보에 액세스합니다.

- 1  버튼을 눌러 메뉴에 액세스합니다.를 누릅니다.

- 2  또는  을 눌러 Bluetooth 및 선택하려면  버튼을 누릅니다.로 이동합니다.

- 3  또는  을 눌러 실내 위치 및 선택하려면  버튼을 누릅니다.로 이동합니다.

- 4  또는  을 눌러 비콘 및 선택하려면  버튼을 누릅니다.로 이동합니다.

디스플레이에 비콘 정보가 표시됩니다.

알림 목록

무전기에는 채널에서 읽지 않은 문자 메시지, 부재 중 수신 통화, 호출 경보 등의 "읽지 않은" 모든 이벤트를 수집하는 알림 목록이 있습니다.

알림 목록에 하나 이상의 이벤트가 있을 경우 상태 표시줄에 알림 아이콘이 나타납니다.

목록은 최대 40개의 읽지 않은 이벤트를 지원하며 목록이 꽉 차면 다음 이벤트가 가장 오래된 이벤트를 자동으로 대체합니다.







주의:



읽은 이벤트는 알림 목록에서 제거됩니다.

알림 목록에 액세스

다음 절차에 따라 무전기에서 알림 목록에 액세스합니다.

- 1  버튼을 눌러 메뉴에 액세스합니다.을 누릅니다.

- 2  또는  버튼을 눌러 알림 및 선택하려면  버튼을 누릅니다.로 이동합니다.

- 3  또는  버튼을 눌러 원하는 이벤트로 이동하고 선택하려면  버튼을 누릅니다..

홈 화면으로 돌아가려면  버튼을 길게 누릅니다.

Wi-Fi 작동

이 기능을 통해서 Wi-Fi 네트워크를 설정하고 연결할 수 있습니다. Wi-Fi는 무선 펌웨어, 코드플러그 및 언어 팩 및 음성 안내와 같은 리소스에 대한 업데이트를 지원합니다.



주의:

이 기능은 XiR M8668i/CM7668i에만 적용됩니다.

Wi-Fi®는 Wi-Fi Alliance®의 등록 상표입니다.

본 무전기는 WEP/WPA/WPA2 개인용 및 WPA/WPA2 기업용 Wi-Fi 네트워크를 지원합니다.

WEP/WPA/WPA2 개인용 Wi-Fi 네트워크

사전 공유 키(암호) 기반 인증을 사용합니다.

사전 공유 키는 메뉴 또는 CPS/RM을 사용하여 입력할 수 있습니다.

WPA/WPA2 기업용 Wi-Fi 네트워크

인증서 기반 인증을 사용합니다.

무전기에는 인증서가 미리 구성되어 있어야 합니다.



주의:

WPA/WPA2 기업용 Wi-Fi 네트워크에 연결하려면 판매점 또는 시스템 관리자에게 문의하십시오.

대리점이나 시스템 관리자가 프로그래밍된 **Wi-Fi 켜기 또는 끄기** 버튼이 할당합니다. 무전기가 프로그래밍된 방식에 대해서는 대리점이나 시스템 관리자에게 문의하십시오.

프로그래밍된 **Wi-Fi 켜기 또는 끄기** 버튼에 대한 음성 안내는 사용자의 요구 사항에 따라 CPS를 통해 맞춤 설정할 수 있습니다. 자세한 내용은 대리점이나 시스템 관리자에게 문의하십시오.



주의:

감독자 무선 시스템을 사용하여 Wi-Fi를 원격으로 켜거나 끌 수 있습니다(**감독 기능 무전기를 사용하여 Wi-Fi 켜기 또는 끄기** 참조). 자세한 내용은 대리점이나 시스템 관리자에게 문의하십시오.

Wi-Fi 켜기 또는 끄기

절차에 따라 Wi-Fi를 켜고 끕니다.

1 프로그래밍된 **Wi-Fi 켜기 또는 끄기** 버튼을 누릅니다. Wi-Fi 켜기 또는 Wi-Fi 끄기라는 음성 안내가 들립니다.

2 메뉴를 사용하여 이 기능에 액세스합니다.

a 버튼을 눌러 메뉴에 액세스합니다. 버튼을 누릅니다.

b 또는 를 눌러 WiFi 및 선택하려면 버튼을 누릅니다.로 이동합니다.

c 또는 를 눌러 WiFi 켜기 및 선택하려면 버튼을 누릅니다.로 이동합니다.

d 을 눌러 Wi-Fi를 켜거나 끕니다.

Wi-Fi가 켜지면 디스플레이에 가 활성화됨 옆에 표시됩니다.

Wi-Fi가 꺼지면 디스플레이에 가 활성화됨 옆에서 사라집니다.

지정된 무전기를 사용하여 원격으로 Wi-Fi 켜기 또는 끄기(개별 제어)



다음 절차에 따라 개별 제어(일대일)에서 원격으로 Wi-Fi를 켜고 끕니다.









주의:



특정 CPS 설정이 있는 무전기만이 이 기능을 지원합니다. 자세한 내용은 대리점이나 시스템 관리자에게 문의하십시오.

1 다음 중 하나를 수행합니다.

- 프로그래밍 가능 버튼을 길게 누릅니다. 키패드를 사용하여 ID와 선택하려면  버튼을 누릅니다. 을 입력합니다. 단계 3로 진행합니다.
-  버튼을 눌러 메뉴에 액세스합니다. 버튼을 누릅니다.

2  또는  버튼을 눌러 연락처 및 선택하려면  버튼을 누릅니다.로 이동합니다.

3  또는  버튼을 눌러 WiFi 제어로 이동한 다음  버튼을 눌러 선택합니다.

4  또는  버튼을 눌러 켜기 또는 끄기를 선택합니다.

5  버튼을 눌러 선택합니다.

성공한 경우 디스플레이에 선택 미니 알림이 표시됩니다.

실패한 경우 디스플레이에 해제 미니 알림이 표시됩니다.

지정된 무전기를 사용하여 원격으로 Wi-Fi 켜기 또는 끄기(그룹 제어)



절차에 따라 그룹 제어(일대다)에서 원격으로 Wi-Fi를 켜고 끕니다.







주의:



특정 CPS 설정이 있는 무전기만이 이 기능을 지원합니다. 자세한 내용은 대리점이나 시스템 관리자에게 문의하십시오.

1  버튼을 눌러 메뉴에 액세스합니다. 버튼을 누릅니다.

2  또는  버튼을 눌러 연락처 및 선택하려면  버튼을 누릅니다.로 이동합니다.

3  또는  버튼을 눌러 원하는 가입자 별칭 또는 ID를 선택합니다.

4  또는  버튼을 눌러 WiFi 제어로 이동한 다음  버튼을 눌러 선택합니다.

5  또는  버튼을 눌러 켜기 또는 끄기를 선택합니다.

6  버튼을 눌러 선택합니다.

성공한 경우 디스플레이에 전송 성공이 표시됩니다.

실패한 경우 디스플레이에 해제 미니 알림이 표시됩니다.

네트워크 액세스 포인트에 연결

Wi-Fi를 켜면 무전기가 네트워크 액세스 포인트를 스캔하여 연결합니다.









주의:



메뉴를 통해서도 네트워크 액세스 포인트에 연결할 수 있습니다.

WPA 기업용 Wi-Fi 네트워크 액세스 포인트는 사전 구성되어 있습니다. 무전기가 프로그래밍된 방식에 대해서는 대리점이나 시스템 관리자에게 문의하십시오.

1  버튼을 눌러 메뉴에 액세스합니다. 버튼을 누릅니다.

2  또는  를 눌러 WiFi 및 선택하려면  버튼을 누릅니다.로 이동합니다.



3  또는  을 눌러 네트워크 및 선택하려면  버튼을 누릅니다.로 이동합니다.

- 4  또는  을 눌러 네트워크 액세스 포인트 및 선택하려면  버튼을 누릅니다.로 이동합니다.



주의:

WPA 기업용 Wi-Fi의 경우 네트워크 액세스 포인트가 사전 구성되어 있지 않으면 연결 옵션을 사용할 수 없습니다.

- 5  또는  을 눌러 연결 및 선택하려면  버튼을 누릅니다.로 이동합니다.

- 6 WPA 개인용 Wi-Fi의 경우 암호를 입력하고  버튼을 누릅니다.

- 7 WPA 기업용 Wi-Fi의 경우 RM을 사용하여 암호를 구성합니다.

사전 구성된 암호가 맞으면 선택한 네트워크 액세스 포인트에 무전기가 자동으로 연결됩니다.

사전 구성된 암호가 틀리면 디스플레이에 인증 실패가 표시되고 자동으로 이전 메뉴로 돌아갑니다.

연결에 실패하면 무전기 디스플레이에 실패 알림이 잠깐 동안 표시되고 자동으로 이전 메뉴로 돌아갑니다.

Wi-Fi 연결 상태 확인

다음 절차에 따라 Wi-Fi 연결 상태를 확인합니다.

음성 안내를 통해 연결 상태에 대한 프로그래밍된 **Wi-Fi 상태 퀴리** 버튼을 누릅니다. Wi-Fi 꺼짐, Wi-Fi가 켜졌지만 연결 없음 또는 Wi-Fi가 켜지고 연결됨이라는 음성 안내가 들립니다.

- Wi-Fi가 꺼지면 디스플레이에 **WiFi 끄기**가 표시됩니다.
- 무전기가 네트워크에 연결되면 디스플레이에 **WiFi 켜기**, 연결됨이 표시됩니다.
- Wi-Fi가 켜졌지만 무전기가 네트워크에 연결되지 않은 경우 **WiFi 켜기**, 연결 끊어짐이 표시됩니다.

Wi-Fi 상태 퀴리 결과에 대한 음성 안내는 사용자의 요구 사항에 따라 CPS를 통해 맞춤 설정할 수 있습니다. 자세한 내용은 대리점이나 시스템 관리자에게 문의하십시오.

연결에 성공하면 무전기에 알림이 표시되며 네트워크 액세스 포인트가 프로필 목록에 저장됩니다.



주의:

프로그래밍된 **Wi-Fi 상태 쿼리** 버튼은 대리점이나 시스템 관리자에 의해 지정됩니다. 무전기가 프로그래밍된 방식에 대해서는 대리점이나 시스템 관리자에게 문의하십시오.

네트워크 목록 새로 고침

다음 절차에 따라 네트워크 목록을 새로 고칩니다.

- 메뉴를 통해 네트워크 목록을 새로 고치려면 다음 작업을 수행합니다.

- a. 버튼을 눌러 메뉴에 액세스합니다. 버튼을 누릅니다.
- b. 또는 를 눌러 WiFi 및 선택하려면 버튼을 누릅니다.로 이동합니다.
- c. 또는 을 눌러 네트워크 및 선택하려면 버튼을 누릅니다.로 이동합니다.

네트워크 메뉴를 입력하면 무전기에서 자동으로 네트워크 목록을 새로 고칩니다.

- 네트워크 메뉴에 이미 있는 경우, 다음 작업을 수행하여 네트워크 목록을 새로 고침할 수 있습니다.

또는 버튼을 눌러 새로 고침으로 이동하고 선택하려면 버튼을 누릅니다..

무전기에서 새로 고침한 뒤 최신 네트워크 목록을 표시합니다.

네트워크 추가





주의:



이 작업은 WPA 기업용 Wi-Fi 네트워크에는 적용되지 않습니다.

기본 설정 네트워크가 사용 가능한 네트워크 목록에 없는 경우 다음 작업을 수행하여 네트워크를 추가할 수 있습니다.



- 1 버튼을 눌러 메뉴에 액세스합니다.를 누릅니다.

- 2 또는 를 눌러 WiFi 및 선택하려면 버튼을 누릅니다.로 이동합니다.

- 3  또는  을 눌러 네트워크 및 선택하려면  버튼을 누릅니다.로 이동합니다.

- 4  또는  버튼을 눌러 네트워크 추가로 이동하고 선택하려면  버튼을 누릅니다..

- 5 SSID(Service Set Identifier)를 입력하고  을 누릅니다.



- 6  또는  버튼을 눌러 열기로 이동하고 선택하려면  버튼을 누릅니다..



- 7 암호를 입력하고  을 누릅니다.
무전기에 선택 미니 알람이 표시되어 네트워크가 성공적으로 저장되었음을 나타냅니다.



네트워크 액세스 포인트의 세부 항목 보기



네트워크 액세스 포인트의 세부 정보를 볼 수 있습니다.

- 1  버튼을 눌러 메뉴에 액세스합니다.를 누릅니다.

- 2  또는  를 눌러 WiFi 및 선택하려면  버튼을 누릅니다.로 이동합니다.

- 3  또는  을 눌러 네트워크 및 선택하려면  버튼을 누릅니다.로 이동합니다.

- 4  또는  을 눌러 네트워크 액세스 포인트 및 선택하려면  버튼을 누릅니다.로 이동합니다.

- 5  또는  버튼을 눌러 세부 항목 보기로 이동하고 선택하려면  버튼을 누릅니다..



주의:

WPA 개인용 Wi-Fi 및 WPA 기업용 Wi-Fi는 네트워크 액세스 포인트에 대한 서로 다른 세부 정보를 표시합니다.

WPA 개인용 Wi-Fi

연결된 네트워크 액세스 포인트의 경우 무전기에 SSID(Service Set Identifier), 보안 모드, MAC(media

Access Control) 주소 및 IP(Internet Protocol) 주소가 표시됩니다.

연결되지 않은 네트워크 액세스 포인트의 경우 무전기에 SSID 및 보안 모드가 표시됩니다.

WPA 기업용 Wi-Fi

연결된 네트워크 액세스 포인트의 경우 무전기에 SSID, 보안 모드, ID, EAP(Extended Authentication Protocol) 방식, 2단계 인증, 인증서 이름, MAC 주소, IP 주소, 게이트웨이, DNS1 및 DNS2가 표시됩니다.

연결되지 않은 네트워크 액세스 포인트의 경우 무전기에 SSID, 보안 모드, ID, EAP 방식, 2단계 인증 및 인증서 이름이 표시됩니다.

네트워크 액세스 포인트 제거









주의:



이 작업은 기업 Wi-Fi 네트워크에는 적용되지 않습니다.



프로파일 목록에서 네트워크 액세스 포인트를 제거하려면 다음 작업을 수행합니다.



- 1  버튼을 눌러 메뉴에 액세스합니다. 버튼을 누릅니다.

- 2  또는  를 눌러 WiFi 및 선택하려면  버튼을 누릅니다.로 이동합니다.

- 3  또는  을 눌러 네트워크 및 선택하려면  버튼을 누릅니다.로 이동합니다.

- 4  또는  버튼을 눌러 선택한 네트워크 액세스 지점으로 이동하고 선택하려면  버튼을 누릅니다..

- 5  또는  버튼을 눌러 제거로 이동하고 선택하려면  버튼을 누릅니다..

- 6  또는  버튼을 눌러 예로 이동하고 선택하려면  버튼을 누릅니다..
무전기에 선택 미니 알림이 표시되어 선택한 네트워크 액세스 포인트가 성공적으로 제거되었음을 나타냅니다.

공공설비



이 장에서는 무전기에서 사용할 수 있는 유틸리티 기능의 작동에 대해 설명합니다.



무전기 톤/경보 켜기 또는 끄기



필요할 경우 모든 무전기 톤과 경보(들어오는 비상 경보음 제외)를 활성화하거나 비활성화할 수 있습니다.



프로그래밍된 **모든 신호음/경보** 버튼을 누릅니다. 버튼을 눌러 전체 톤을 켜거나 끕니다. 또는 다음에 설명하는 절차에 따라 무전기 메뉴에서 이 기능에 액세스합니다.

1  버튼을 눌러 메뉴에 액세스합니다. 버튼을 누릅니다.

2  또는  버튼을 눌러 유틸리티로 이동하고 선택하려면  버튼을 누릅니다.합니다.

3  또는  버튼을 눌러 무전기 설정으로 이동하고 선택하려면  버튼을 누릅니다.합니다.

4  또는  버튼을 눌러 톤/경보로 이동하고 선택하려면  버튼을 누릅니다.합니다.

5  또는  버튼을 눌러 모든 톤으로 이동하고 선택하려면  버튼을 누릅니다.합니다.

6  버튼을 눌러 전체 톤 및 경보를 활성화하거나 비활성화합니다.



디스플레이의 활성화됨 옆에 ✓가 표시됩니다.



✓아이콘이 활성화 옆에서 사라집니다.



톤/경보 최소 볼륨 레벨 설정



필요할 경우 톤/경보 최소 볼륨 레벨을 조절할 수 있습니다. 이 기능은 톤/경보의 볼륨을 해당 음성의 볼륨보다 크거나 작게 조절합니다.



1  버튼을 눌러 메뉴에 액세스합니다.을 누릅니다.

2  또는  을 눌러 유틸리티 및 선택하려면  버튼을 누릅니다.로 이동합니다.



3  또는  을 눌러 무전기 설정으로 이동하고 선택하려면  버튼을 누릅니다..

4  또는  버튼을 눌러 톤/경보 및 선택하려면  버튼을 누릅니다.로 이동합니다.

5  또는  버튼을 눌러 볼륨 오프셋 및 선택하려면  버튼을 누릅니다.로 이동합니다.

6  또는  버튼을 눌러 원하는 볼륨 값으로 이동합니다.
각각의 해당 볼륨 값과 함께 무전기에서 피드백 경보음이 울립니다.



7 다음 중 하나를 수행합니다.



-  버튼을 눌러 원하는 표시된 볼륨 값을 유지합니다.
-  버튼을 눌러 현재의 최소 볼륨 설정을 변경하지 않고 종료합니다.



통화 허용 경보음 켜기 또는 끄기



필요할 경우 통화 허용 경보음을 활성화하거나 비활성화할 수 있습니다.

1  버튼을 눌러 메뉴에 액세스합니다.을 누릅니다.

2  또는  을 눌러 유틸리티 및 선택하려면  버튼을 누릅니다.로 이동합니다.

3  또는  을 눌러 무전기 설정으로 이동하고 선택하려면  버튼을 누릅니다..

4  또는  버튼을 눌러 톤/경보 및 선택하려면  버튼을 누릅니다.로 이동합니다.



5  또는  버튼을 눌러 통화 허용 경보음 및 선택하려면  버튼을 누릅니다.로 이동합니다.



6  버튼을 눌러 통화 허용 경보음을 활성화하거나 비활성화합니다.
디스플레이의 활성화됨 옆에 ✓가 표시됩니다.
✓아이콘이 활성화 옆에서 사라집니다.



출력 증강 경보음 켜기 및 끄기



출력 증강 경보음을 작동 또는 정지할 수 있습니다.

1  버튼을 눌러 메뉴에 액세스합니다.을 누릅니다.

2  또는  을 눌러 유틸리티 및 선택하려면  버튼을 누릅니다.로 이동합니다.

3  또는  을 눌러 무전기 설정으로 이동하고 선택하려면  버튼을 누릅니다..

4  또는  버튼을 눌러 톤/경보 및 선택하려면  버튼을 누릅니다.로 이동합니다.

5  또는  버튼을 눌러 출력 증강 및 선택하려면  버튼을 누릅니다.로 이동합니다.

6  버튼을 눌러 출력 증강 경보음을 활성화하거나 비활성화합니다.
디스플레이의 활성화됨 옆에 ✓가 표시됩니다.
✓아이콘이 활성화 옆에서 사라집니다.

전원 레벨 설정

무전기 전력 설정을 각 **Connect Plus** 채널에 대해 높음 또는 낮음으로 사용자 정의할 수 있습니다.

높음으로 설정하면 원거리 전송탑 사이트와 **Connect Plus** 모드로 통신할 수 있습니다. 낮음으로 설정하면 근거리 전송탑 사이트와 **Connect Plus** 모드로 통신할 수 있습니다.

프로그래밍된 **전력 레벨** 버튼을 누릅니다. 버튼을 눌러 높음과 낮음 사이에서 전송 전력 레벨을 전환합니다.

다음에 설명하는 단계를 수행하여 무전기 메뉴에서 이 기능에 액세스합니다.

- 1  버튼을 눌러 메뉴에 액세스합니다. 버튼을 누릅니다.

- 2  또는  버튼을 눌러 유틸리티로 이동하고 선택하려면  버튼을 누릅니다.합니다.

- 3  또는  버튼을 눌러 무전기 설정으로 이동하고 선택하려면  버튼을 누릅니다.합니다.

- 4  또는  버튼을 눌러 전원으로 이동하고 선택하려면  버튼을 누릅니다.합니다.



- 5  또는  버튼을 눌러 원하는 설정으로 이동하고 선택하려면  버튼을 누릅니다.합니다.



✓가 선택한 설정 옆에 표시됩니다. 홈 화면으로 돌아가려면 언제든지  버튼을 길게 누릅니다. 화면은 이전 메뉴로 돌아갑니다.



디스플레이 모드 변경



필요에 따라 무전기 디스플레이 모드를 주간이나 야간으로 변경할 수 있습니다. 디스플레이 모드 변경은 디스플레이의 색상표에 영향을 줍니다.

- 1  버튼을 눌러 메뉴에 액세스합니다.을 누릅니다.

- 2  또는  을 눌러 유틸리티 및 선택하려면  버튼을 누릅니다.로 이동합니다.

- 3  또는  을 눌러 무전기 설정으로 이동하고 선택하려면  버튼을 누릅니다..

4  또는  을 눌러 디스플레이 및 선택하려면  버튼을 누릅니다.로 이동합니다.
디스플레이에 주간 모드와 야간 모드가 표시됩니다.

5  또는  버튼을 눌러 원하는 설정으로 이동하고  버튼을 눌러 활성화합니다. ✓ 선택한 설정 옆에 가 표시됩니다.

디스플레이 선명도 조절



필요에 따라 무전기의 디스플레이 밝기를 조절할 수 있습니다.









주의:



밝기 자동이 활성화된 경우에는 디스플레이 밝기를 조절할 수 없습니다.



1  버튼을 눌러 메뉴에 액세스합니다.을 누릅니다.

2  또는  을 눌러 유틸리티 및 선택하려면  버튼을 누릅니다.로 이동합니다.

3  또는  을 눌러 무전기 설정으로 이동하고 선택하려면  버튼을 누릅니다..

4  또는  을 눌러 디스플레이 및 선택하려면  버튼을 누릅니다.로 이동합니다.



5  또는  을 눌러 선명도 및 선택하려면  버튼을 누릅니다.로 이동합니다.
디스플레이에 진행률 표시줄이 나타납니다.



6  버튼을 눌러 디스플레이 선명도를 줄이거나,  버튼을 눌러 디스플레이 선명도를 늘립니다. 1에서 8까지의 설정 중에서 선택합니다.  버튼을 눌러 현재의 입력을 확인합니다.



홈 화면 켜기 또는 끄기



필요할 경우 홈 화면을 활성화하거나 비활성화할 수 있습니다.

1  버튼을 눌러 메뉴에 액세스합니다.을 누릅니다.

2  또는  을 눌러 유틸리티 및 선택하려면  버튼을 누릅니다.로 이동합니다.

3  또는  을 눌러 무전기 설정으로 이동하고 선택하려면  버튼을 누릅니다..

4  또는  을 눌러 디스플레이 및 선택하려면  버튼을 누릅니다.로 이동합니다.

5  또는  버튼을 눌러 초기 화면 및 선택하려면  버튼을 누릅니다.로 이동합니다.

6  버튼을 눌러 홈 화면을 활성화하거나 비활성화합니다.



디스플레이의 활성화됨 옆에 ✓가 표시됩니다.



✓아이콘이 활성화 옆에서 사라집니다.



언어



원하는 언어로 무전기 디스플레이를 설정할 수 있습니다.

1  버튼을 눌러 메뉴에 액세스합니다.을 누릅니다.

2  또는  을 눌러 유틸리티 및 선택하려면  버튼을 누릅니다.로 이동합니다.











3  또는  을 눌러 무전기 설정으로 이동하고 선택하려면  버튼을 누릅니다..

4  또는  버튼을 눌러 언어 및 선택하려면  버튼을 누릅니다.로 이동합니다.

- 5  또는  버튼을 눌러 원하는 언어로 이동하고  버튼을 눌러 활성화합니다. ✓ 선택한 언어 옆에 가 표시됩니다.

LED 표시 켜기 또는 끄기











필요한 경우 LED 표시를 활성화하거나 비활성화할 수 있습니다.

- 1  버튼을 눌러 메뉴에 액세스합니다.을 누릅니다.
- 2  또는  을 눌러 유틸리티 및 선택하려면  버튼을 누릅니다.로 이동합니다.
- 3  또는  을 눌러 무전기 설정으로 이동하고 선택하려면  버튼을 누릅니다..
- 4  또는  버튼을 눌러 LED 표시 및 선택하려면  버튼을 누릅니다.로 이동합니다.

- 5  버튼을 눌러 LED 표시를 활성화하거나 비활성화합니다.
디스플레이의 활성화됨 옆에 ✓가 표시됩니다.
✓아이콘이 활성화 옆에서 사라집니다.

케이블 타입 식별

무전기에 사용되는 케이블 타입을 선택할 수 있습니다.



- 1  버튼을 눌러 메뉴에 액세스합니다.을 누릅니다.
- 2  또는  을 눌러 유틸리티 및 선택하려면  버튼을 누릅니다.로 이동합니다.
- 3  또는  을 눌러 무전기 설정으로 이동하고 선택하려면  버튼을 누릅니다..
- 4  또는  버튼을 눌러 케이블 타입으로 이동하고 선택하려면  버튼을 누릅니다..



5 현재 케이블 타입은 로 표시됩니다.



음성 안내

이 기능을 사용하면 무전기에서 사용자가 막 지정한 현재 존 또는 채널이나 프로그래밍 가능 버튼 누름을 청각적으로 나타낼 수 있습니다. 이 오디오 표시 기능은 고객 요구에 맞게 사용자 정의할 수 있습니다. 이 기능은 사용자가 디스플레이에 표시된 내용을 읽기 어려운 상황일 때 특히 유용합니다.

1  버튼을 눌러 메뉴에 액세스합니다. 버튼을 누릅니다.





2  또는  버튼을 눌러 유틸리티로 이동하고 선택하려면  버튼을 누릅니다.합니다.

3  또는  버튼을 눌러 무전기 설정으로 이동하고 선택하려면  버튼을 누릅니다.합니다.

4  또는  을 눌러 음성 안내로 이동하고 선택하려면  버튼을 누릅니다.합니다.

또한 또는 버튼을 사용하여 선택된 옵션을 변경할 수도 있습니다.



5 다음 중 하나를 수행합니다.



-  버튼을 눌러 음성 안내를 활성화합니다. 디스플레이의 활성화됨 옆에 가 표시됩니다.
-  버튼을 눌러 음성 안내를 비활성화합니다.  아이콘이 활성화 옆에서 사라집니다.



메뉴 타이머



무전기가 홈 화면으로 자동 전환되기 전에 메뉴에 머무를 시간을 설정합니다.



1  버튼을 눌러 메뉴에 액세스합니다.을 누릅니다.

2  또는  을 눌러 유틸리티 및 선택하려면  버튼을 누릅니다.로 이동합니다.

3  또는  을 눌러 무전기 설정으로 이동하고 선택하려면  버튼을 누릅니다..

4  또는  을 눌러 디스플레이 및 선택하려면  버튼을 누릅니다.로 이동합니다.

5  또는  버튼을 눌러 메뉴 타이머로 이동하고 선택하려면  버튼을 누릅니다..

6  또는  버튼을 눌러 원하는 설정으로 이동하고 선택하려면  버튼을 누릅니다..

혼/라이트 켜기 또는 끄기



이 기능은 대리점에서 무전기의 후면 액세스리 커넥터를 통해 설치해야 합니다.



무전기는 혼 및 라이트 기능을 통해 사용자에게 수신 호출을 알릴 수 있습니다. 활성화된 경우 호출이 들어오면 차량의 혼이 울리고 라이트가 켜집니다.



1 다음 중 하나를 수행합니다.

- 프로그래밍된 **경적/라이트** 버튼을 눌러 경적 및 라이트 기능을 켜거나 끕니다. 다음 단계를 건너뛸니다.

-  버튼을 눌러 메뉴에 액세스합니다.을 누릅니다.

2  또는  을 눌러 유틸리티 및 선택하려면  버튼을 누릅니다.로 이동합니다.

3  또는  을 눌러 무전기 설정으로 이동하고 선택하려면  버튼을 누릅니다..

4  또는  버튼을 눌러 경적/라이트 및 선택하려면  버튼을 누릅니다.로 이동합니다.

5  버튼을 눌러 혼/라이트를 활성화하거나 비활성화합니다.



디스플레이의 활성화됨 옆에 ✓가 표시됩니다.



✓아이콘이 활성화 옆에서 사라집니다.



이중 노브 작동 기본 설정 지정



무전기에 두 가지 용도의 **볼륨/채널 노브**가 있습니다. 두 가지 용도의 옵션을 비활성화하면 노브가 볼륨 노브로만 작동하도록 설정됩니다.

- 1  버튼을 눌러 메뉴에 액세스합니다..

- 2  또는  선택하려면  버튼을 누릅니다.
버튼을 눌러 유틸리티로 이동하고.

- 3  또는  선택하려면  버튼을 누릅니다.
버튼을 눌러 무전기 설정으로 이동하고.



- 4  또는  선택하려면  버튼을 누릅니다.
버튼을 눌러 이중 노브로 이동하고.



- 5 디스플레이에 볼륨 전용과 볼륨 & 채널이 표시됩니다.  또는  선택하려면  버튼을 누릅니다.
버튼을 눌러 원하는 설정으로 이동하고.
✓가 선택한 설정 옆에 표시됩니다.
화면은 이전 메뉴로 돌아옵니다.



디지털 마이크 AGC(마이크 AGC-D)

이 기능은 디지털 시스템에서 전송하는 동안 자동으로 무전기의 마이크 게인을 제어합니다. 일정한 수준의 오디오를 제공하기 위해 큰 소리가 억제되거나 작은 소리가 미리 설정된 값만큼 커집니다.



- 1  버튼을 눌러 메뉴에 액세스합니다.을 누릅니다.

- 2  또는  을 눌러 유틸리티 및 선택하려면  버튼을 누릅니다.로 이동합니다.

- 3  또는  을 눌러 무전기 설정으로 이동하고 선택하려면  버튼을 누릅니다..

- 4  또는  버튼을 눌러 마이크 AGC-D로 이동하고 선택하려면  버튼을 누릅니다..





- 5 다음 중 하나를 수행합니다.
 -  버튼을 눌러 **마이크 AGC-D**를 활성화합니다. 디스플레이의 활성화됨 옆에 ✓가 표시됩니다.

-  버튼을 눌러 **마이크 AGC-D** 를 비활성화합니다.  아이콘이 활성화됨.



지능형 오디오



고정된 잡음원과 고정되지 않은 잡음원 모두를 포함하여 환경의 주변 소음을 억제하기 위해 무전기의 오디오 볼륨이 자동으로 조절될 수 있습니다. 이 기능은 수신 전용 기능이며 전송음에는 영향을 주지 않습니다.

- 1  버튼을 눌러 메뉴에 액세스합니다. 버튼을 누릅니다.

무전 단계 기권 트를	
메뉴	<p>a  버튼을 눌러 메뉴에 액세스합니다. 버튼을 누릅니다.</p> <p>b  또는  버튼을 눌러 무전기 설정으로 이동하고 선택하려면  버튼을 누릅니다.합니다.</p>

무전 단계 기권 트를

c  또는  버튼을 눌러 무전기 설정으로 이동하고 선택하려면  버튼을 누릅니다.합니다.



d  또는  버튼을 눌러 지능형 오디오로 이동하고 선택하려면  버튼을 누릅니다..







주의:



또한 또는 버튼을 사용하여 선택된 옵션을 변경할 수도 있습니다.



e 다음 중 하나를 수행합니다.

-  버튼을 눌러 지능형 오디오 를 활성화합니다. 디스플레이의 활성화됨 옆에  가 표시됩니다.

무전 기 컨 트롤	단계
	<ul style="list-style-type: none"> •  버튼을 눌러 지능형 오디오를 비활성화합니다. ✓아이콘이 활성화 옆에서 사라집니다.

2  또는  버튼을 눌러 유틸리티로 이동하고 선택하려면  버튼을 누릅니다.합니다.

3  또는  버튼을 눌러 무전기 설정으로 이동하고 선택하려면  버튼을 누릅니다.합니다.

4  또는  버튼을 눌러 지능형 오디오로 이동하고 선택하려면  버튼을 누릅니다..

5 다음 중 하나를 수행합니다.

-  버튼을 눌러 지능형 오디오를 활성화합니다. 디스플레이의 활성화됨 옆에 ✓가 표시됩니다.



-  버튼을 눌러 지능형 오디오를 비활성화합니다. ✓아이콘이 활성화 옆에서 사라집니다.



유사한 성능을 위한 자동 볼륨 제어가 기본적으로 포함된 권장되는 블루투스 사용 오디오 액세스리에 대해서는 승인된 액세스리 목록을 참조하십시오.



음향 피드백 억제기 기능 켜기 또는 끄기

이 기능은 수신된 호출에서 발생하는 음향 피드백을 최소화합니다.

1  버튼을 눌러 메뉴에 액세스합니다.을 누릅니다.





2  또는  을 눌러 유틸리티 및 선택하려면  버튼을 누릅니다.로 이동합니다.

3  또는  을 눌러 무전기 설정으로 이동하고 선택하려면  버튼을 누릅니다..

4  또는  버튼을 눌러 AF 피드백 억제기 및 선택하려면  버튼을 누릅니다.로 이동합니다.

또한 또는 버튼을 사용하여 선택된 옵션을 변경할 수도 있습니다.

5 다음 중 하나를 수행합니다.

-  버튼을 눌러 음향 피드백 억제기를 활성화합니다. 디스플레이의 활성화됨 옆에 가 표시됩니다.
-  버튼을 눌러 음향 피드백 억제기를 비활성화합니다. 아이콘이 활성화 옆에서 사라집니다.

GNSS 켜기 또는 끄기

GNSS(위성항법시스템)는 무전기의 정확한 위치를 결정하는 위성 탐색 시스템입니다. GNSS에는 GPS(Global Positioning System), GLONASS(Global Navigation Satellite System) 및 BDS(BeiDou Navigation Satellite System)가 포함됩니다.





주의:

선택한 무전기 모델은 GPS, GLONASS 및 BDS를 제공할 수 있습니다. GNSS 위성항법 시스템은 CPS를 사용하여 구성됩니다. 무전기가 프로그래밍된 방식에 대해서는 대리점이나 시스템 관리자에게 문의하십시오.



1 다음 중 하나를 수행합니다.

- 프로그래밍된 **GNSS** 버튼을 눌러 기능을 켜거나 끕니다. 다음 단계를 건너뛵니다.
-  버튼을 눌러 메뉴로 이동합니다.



2



 또는  버튼을 눌러 유틸리티로 이동합니다.  버튼을 눌러 선택합니다.

3

 또는  버튼을 눌러 무전기 설정으로 이동합니다.  버튼을 눌러 선택합니다.

4

 또는  을 눌러 GNSS로 이동합니다.  버튼을 눌러 선택합니다.



- 5  버튼을 눌러 GNSS를 활성화하거나 비활성화합니다.
- 활성화되면  아이콘이 활성화 옆에 표시됩니다.
- 비활성화되면  아이콘이 활성화 옆에서 사라집니다.

GNSS 정보 찾기에 대한 자세한 내용은 [GNSS 정보 확인 페이지의 318](#)을 참조하십시오.

일반 무전기 정보 액세스







무전기에는 다음에 대한 정보가 포함되어 있습니다.



- 배터리
- 틸트 각도(가속도계)
- 무전기 모델 번호 색인
- 옵션 보드 OTA(Over-the-Air) 코드플러그 CRC
- 사이트 번호
- 사이트 정보
- 무전기 별칭 및 ID
- 펌웨어 및 코드플러그 버전
- GNSS 정보

이전 화면으로 돌아가려면 언제든지  버튼을 누르거나, 홈 화면으로 돌아가려면  버튼을 길게 누릅니다. 무전기는 비활성 타이머가 만료되는 즉시 현재 화면을 종료합니다.

무전기 모델 번호 색인 확인







색인 번호는 무전기 모델별 하드웨어를 식별합니다. 무전기 시스템 관리자가 무전기의 새 옵션 보드 코드플러그를 준비할 때 이 번호를 물어볼 수 있습니다.



- 1  버튼을 눌러 메뉴에 액세스합니다.을 누릅니다.
- 2  또는  을 눌러 유틸리티 및 선택하려면  버튼을 누릅니다.로 이동합니다.
- 3  또는  을 눌러 무전기 정보 및 선택하려면  버튼을 누릅니다.로 이동합니다.

- 4  또는  버튼을 눌러 모델 색인으로 이동하고 선택하려면  버튼을 누릅니다.
디스플레이에 모델 번호 색인이 표시됩니다.

옵션 보드 OTA 코드플러그 파일의 CRC 확인

무전기 관리자가 옵션 보드 OTA 코드플러그 파일 CRC(Cyclic Redundancy Check)를 요청한 경우 아래 지침에 따릅니다. 옵션 보드가 최신 코드플러그 업데이트를 OTA로 수신한 경우에만 이 메뉴 옵션이 나타납니다.

- 1  버튼을 눌러 메뉴에 액세스합니다.을 누릅니다.
-
- 2  또는  을 눌러 유틸리티 및 선택하려면  버튼을 누릅니다.로 이동합니다.
-
- 3  또는  을 눌러 무전기 정보 및 선택하려면  버튼을 누릅니다.로 이동합니다.

- 4  또는  버튼을 눌러 OB OTA CPcrc로 이동하고 선택하려면  버튼을 누릅니다..
디스플레이에 몇 가지 문자와 숫자가 표시됩니다. 표시된 정보를 정확히 무전기 시스템 관리자에게 알려줍니다.





사이트 ID(사이트 번호) 표시









주의:

현재 사이트에 등록되어 있지 않으면 디스플레이에 등록되지 않음이 표시됩니다.

Connect Plus 사이트에 등록될 때 무전기에 사이트 ID가 짧게 표시됩니다. 등록 후 일반적으로 무전기에 사이트 번호가 표시되지 않습니다. 등록된 사이트 번호를 표시하려면 다음을 수행합니다.

- 1  버튼을 눌러 메뉴에 액세스합니다.을 누릅니다.
-
- 2  또는  을 눌러 유틸리티 및 선택하려면  버튼을 누릅니다.로 이동합니다.

3  또는  을 눌러 무전기 정보 및 선택하려면  버튼을 누릅니다.로 이동합니다.

4  또는  버튼을 눌러 사이트 번호로 이동하고 선택하려면  버튼을 누릅니다..
디스플레이에 네트워크 ID 및 사이트 번호가 표시됩니다.

사이트 정보 확인



주의:



현재 사이트에 등록되어 있지 않으면 디스플레이에 등록되지 않음이 표시됩니다.



사이트 정보 기능은 서비스 기술자에게 유용할 수 있는 정보를 제공하며, 다음 정보로 구성됩니다.



- 현재 컨트롤 채널 중계기의 중계기 번호.
- **RSSI**: 컨트롤 채널 중계기에서 측정한 마지막 신호 강도 값.
- 컨트롤 채널 중계기에서 전송한 인접 목록(5개 숫자를 씬 표로 구분).

이 기능을 사용하라는 요청을 받으면 화면에 표시된 정보를 정확히 보고합니다.

1  버튼을 눌러 메뉴에 액세스합니다.을 누릅니다.

2  또는  을 눌러 유틸리티 및 선택하려면  버튼을 누릅니다.로 이동합니다.

3  또는  을 눌러 무전기 정보 및 선택하려면  버튼을 누릅니다.로 이동합니다.



4  또는  버튼을 눌러 사이트 정보로 이동하고 선택하려면  버튼을 누릅니다..
디스플레이에 사이트 정보가 표시됩니다.



무전기 ID 확인



이 기능은 무전기 ID를 표시합니다.

다음에 설명된 절차에 따라 무전기 화면에서 이 기능에 액세스합니다.

1  버튼을 눌러 메뉴에 액세스합니다.을 누릅니다.

2  또는  을 눌러 유틸리티 및 선택하려면  버튼을 누릅니다.로 이동합니다.



3  또는  을 눌러 무전기 정보 및 선택하려면  버튼을 누릅니다.로 이동합니다.



4  또는  버튼을 눌러 나의 ID 및 선택하려면  버튼을 누릅니다.로 이동합니다.
디스플레이에 무전기 ID가 표시됩니다.



펌웨어 버전 및 코드플러그 버전 확인

무전기에 펌웨어 버전을 표시합니다.

1  버튼을 눌러 메뉴에 액세스합니다.을 누릅니다.

2  또는  을 눌러 유틸리티 및 선택하려면  버튼을 누릅니다.로 이동합니다.

3  또는  을 눌러 무전기 정보 및 선택하려면  버튼을 누릅니다.로 이동합니다.

4  또는  을 눌러 버전 및 선택하려면  버튼을 누릅니다.로 이동합니다.

다음 정보를 포함하는 목록이 표시됩니다.

- (무전기) 펌웨어 버전
 - (무전기) 코드플러그 버전
 - 옵션 보드 펌웨어 버전
 - 옵션 보드 주파수 버전
 - 옵션 보드 하드웨어 버전
 - 옵션 보드 코드플러그 버전
-

업데이트 확인

Connect Plus에는 특정 파일(옵션 보드 코드플러그, 네트워크 주파수 파일 및 옵션 보드 펌웨어 파일)을 무선(OTA)으로 업데이트하는 기능이 있습니다.



주의:

무전기에 이 기능이 활성화되어 있는지 여부를 확인하려면 대리점이나 네트워크 관리자에게 문의하십시오.

모든 디스플레이 **Connect Plus** 무전기에는 메뉴 옵션을 사용하여 현재 옵션 보드 OTA 코드플러그 CRC, 주파수 파일 버전 또는 옵션 보드 펌웨어 파일 버전을 표시하는 기능이 있습니다. 또한 무선(OTA) 파일 전송이 활성화된 디스플레이 무전기는 "대기 중인 파일"의 버전을 표시할 수 있습니다. "대기 중인 파일"은 **Connect Plus** 무전기가 시스템 메시징을 통해 인식했지만 아직 모든 파일 패킷을 수집하지 못한 주파수 파일 또는 옵션 보드 펌웨어 파일입니다. 디스플레이 **Connect Plus** 무전기에 대기 중인 파일이 있으면 메뉴에 다음 옵션이 나타납니다.

- 대기 중인 파일의 버전 번호 보기
- 지금까지 수집된 패킷의 백분율 보기
- 파일 패킷 수집을 다시 시작하도록 **Connect Plus** 무전기에 요청

무전기에 **Connect Plus** OTA 파일 전송이 활성화된 경우 무전기가 사용자에게 확인을 받지 않고 자동으로 파일 전송에 참여할 수 있습니다. 무전기가 파일 패킷을 수집하는 동안 LED가 적색으로 빠르게 점멸하고 무전기의 홈 화면 상태 표시줄에 대용량 데이터 아이콘이 표시됩니다.



주의:

Connect Plus 무전기는 파일 패킷을 수집하는 동안 호출을 수신할 수 없습니다. 파일 전송을 취소하려면 **PTT** 버튼을 눌렀다가 놓으십시오. 그러면 무전기가 선택한 연락처 이름에 대한 호출을 요청하고 나중에 프로세스가 재개될 때까지 해당 무전기에 대한 파일 전송이 취소됩니다.

파일 전송 프로세스가 다시 시작되게 만들 수 있는 여러 상황이 있습니다. 첫 번째 예는 OTA 파일 유형에 적용됩니다. 또 다른 예는 네트워크 주파수 파일 및 옵션 보드 펌웨어 파일에만 적용됩니다.

- 무전기 시스템 관리자가 OTA 파일 전송을 다시 초기화합니다.
- 옵션 보드 미리 정의된 타이머가 완료되어 옵션 보드가 자동으로 패킷 수집 프로세스를 재개합니다.
- 타이머가 완료되지 않았지만 무전기 사용자가 메뉴 옵션을 통해 파일 전송을 재개하도록 요청합니다.

Connect Plus 무전기가 모든 파일 패킷의 다운로드를 마친 후에는 새로 수집된 파일로 업그레이드해야 합니다. 네트워크

크 주파수 파일의 경우 이 업그레이드는 자동 프로세스이며 무전기 재설정이 필요하지 않습니다. 옵션 보드 코드플러그 파일의 경우 이 업그레이드는 자동 프로세스이지만 옵션 보드가 새 코드플러그 정보를 로드하여 네트워크 사이트를 다시 수집해야 하기 때문에 서비스가 일시적으로 중단됩니다. 무전기가 새 옵션 보드 펌웨어로 업그레이드되는 속도는 대리점이나 시스템 관리자가 무전기를 구성한 방식에 따라 다릅니다. 모든 파일을 수집한 후에 즉시 무전기가 업그레이드될 수도 있고, 다음 번에 사용자가 무전기를 켤 때까지 업그레이드가 대기 상태로 유지될 수 있습니다.



주의:

무전기가 프로그래밍된 방식에 대해서는 대리점이나 시스템 관리자에게 문의하십시오.

새 옵션 보드 펌웨어 파일로 업그레이드하는 프로세스에는 몇 초 정도 걸리며, 이 과정에서 **Connect Plus** 옵션 보드가 무전기를 재설정하게 됩니다. 업그레이드가 시작되면 프로세스가 완료될 때까지 무전기 사용자가 호출을 송신하거나 수신할 수 없습니다. 진행 도중 무전기를 끄지 말라는 메시지가 무전기 디스플레이에 표시됩니다.

펌웨어 파일

다음 섹션에서는 무전기 펌웨어 대한 정보를 제공합니다.



펌웨어 업데이트









주의:



옵션 보드 펌웨어 파일이 최신 버전이 아니고 무전기가 최신 옵션 보드 펌웨어 파일 버전을 부분적으로 수집한 경우 무전기에 버전, *수신, 다운로드의 추가 옵션이 포함된 목록이 표시됩니다.

- 1  버튼을 눌러 메뉴에 액세스합니다. **을** 누릅니다.













- 2  또는  을 눌러 유틸리티 및 선택하려면  버튼을 누릅니다. **로** 이동합니다.



- 3  또는  을 눌러 무전기 정보 및 선택하려면  버튼을 누릅니다. **로** 이동합니다.

- 4  또는  을 눌러 업데이트 및 선택하려면  버튼을 누릅니다. **로** 이동합니다.











- 5  또는  을 눌러 펌웨어 및 선택하려면  버튼을 누릅니다.로 이동합니다.
디스플레이에 최신 버전의 펌웨어가 표시됩니다.
-



대기 중인 펌웨어 - 버전



- 1  버튼을 눌러 메뉴에 액세스합니다.을 누릅니다.
-
- 2  또는  을 눌러 유틸리티 및 선택하려면  버튼을 누릅니다.로 이동합니다.
-
- 3  또는  을 눌러 무전기 정보 및 선택하려면  버튼을 누릅니다.로 이동합니다.
-
- 4  또는  을 눌러 업데이트 및 선택하려면  버튼을 누릅니다.로 이동합니다.
-
- 5  또는  을 눌러 펌웨어 및 선택하려면  버튼을 누릅니다.로 이동합니다.
-

- 6  또는  을 눌러 버전 및 선택하려면  버튼을 누릅니다.로 이동합니다.
옵션 보드 펌웨어 파일이 있는 경우 디스플레이에 대기 중인 펌웨어 버전 번호가 표시됩니다.
대기 중인 옵션 보드 펌웨어 파일이 있는 경우 디스플레이에 펌웨어가 최신 상태임이 표시됩니다.
-

대기 중인 펌웨어 - %수신

- 1  버튼을 눌러 메뉴에 액세스합니다.을 누릅니다.
-
- 2  또는  을 눌러 유틸리티 및 선택하려면  버튼을 누릅니다.로 이동합니다.
-
- 3  또는  을 눌러 무전기 정보 및 선택하려면  버튼을 누릅니다.로 이동합니다.
-
- 4  또는  을 눌러 업데이트 및 선택하려면  버튼을 누릅니다.로 이동합니다.
-

5  또는  을 눌러 펌웨어 및 선택하려면  버튼을 누릅니다.로 이동합니다.

6  또는  을 눌러 수신 백분율 및 선택하려면  버튼을 누릅니다.로 이동합니다.
화면에 지금까지 수집된 펌웨어 파일 패키지의 백분율이 표시됩니다.







주의:
백분율이 100%인 경우 펌웨어 업그레이드를 시작하려면 무전기 전원을 껐다가 켜야 합니다.



대기 중인 펌웨어 - 다운로드



Connect Plus 무전기에 일부 파일만 완료된 이전의 OTA 옵션 보드 펌웨어 파일 전송이 있는 경우 내부 타이머가 만료되면 무전기가 자동으로 파일 전송(계속 진행되고 있는 경우)에 다시 참가합니다. 이 내부 타이머가 만료되기 이전에 현재 진행 중인 옵션 보드 펌웨어 파일 전송에 무전기를 다



시 참여하게 하려면 아래 설명된 대로 다운로드 옵션을 사용합니다.



1  버튼을 눌러 메뉴에 액세스합니다.을 누릅니다.

2  또는  을 눌러 유틸리티 및 선택하려면  버튼을 누릅니다.로 이동합니다.

3  또는  을 눌러 무전기 정보 및 선택하려면  버튼을 누릅니다.로 이동합니다.



4  또는  을 눌러 업데이트 및 선택하려면  버튼을 누릅니다.로 이동합니다.

5  또는  을 눌러 펌웨어 및 선택하려면  버튼을 누릅니다.로 이동합니다.

- 6  또는  을 눌러 다운로드 및 선택하려면  버튼을 누릅니다.로 이동합니다. 디스플레이에 다음과 같이 표시됩니다.

다운로드 가능	다운로드 시작
사용 가능한 다운로드 없음	다운로드할 수 없음

- 7 다음 중 하나를 수행합니다.

- 다운로드를 시작하려면 예를 선택하고  버튼을 누릅니다.
- 이전 화면으로 돌아가려면 아니요를 선택하고  버튼을 눌러 이전 메뉴로 돌아갑니다.

주파수 파일











다음 섹션에서는 무전기 주파수 파일 정보를 제공합니다.

주파수 파일 업데이트







주의:



주파수 파일이 최신 버전이 아니고 무전기가 최신 주파수 파일 버전을 부분적으로 수집한 경우 무전기에 버전, 수신, 다운로드의 추가 옵션이 포함된 목록이 표시됩니다.



- 1  버튼을 눌러 메뉴에 액세스합니다.을 누릅니다.
- 2  또는  을 눌러 유틸리티 및 선택하려면  버튼을 누릅니다.로 이동합니다.
- 3  또는  을 눌러 무전기 정보 및 선택하려면  버튼을 누릅니다.로 이동합니다.
- 4  또는  을 눌러 주파수 및 선택하려면  버튼을 누릅니다.로 이동합니다. 디스플레이의 첫 번째 줄에 최신 버전의 주파수 파일이 표시됩니다.



주파수 파일 대기 중- 버전



1  버튼을 눌러 메뉴에 액세스합니다.을 누릅니다.

2  또는  을 눌러 유틸리티 및 선택하려면
 버튼을 누릅니다.로 이동합니다.

3  또는  을 눌러 무전기 정보 및 선택하려면
 버튼을 누릅니다.로 이동합니다.



4  또는  을 눌러 업데이트 및 선택하려면
 버튼을 누릅니다.로 이동합니다.



5  또는  을 눌러 주파수 및 선택하려면 
버튼을 누릅니다.로 이동합니다.



6  또는  을 눌러 버전 및 선택하려면 
버튼을 누릅니다.로 이동합니다.
대기 중인 주파수 파일이 있는 경우 디스플레이에 대기 중인 주파수 파일 버전 번호가 표시됩니다.



주파수 파일 대기 중- 수신 백분율

1  버튼을 눌러 메뉴에 액세스합니다.을 누릅니다.

2  또는  을 눌러 유틸리티 및 선택하려면
 버튼을 누릅니다.로 이동합니다.

3  또는  을 눌러 무전기 정보 및 선택하려면
 버튼을 누릅니다.로 이동합니다.

4  또는  을 눌러 업데이트 및 선택하려면
 버튼을 누릅니다.로 이동합니다.



5  또는  을 눌러 수신 백분율 및 선택하려면
 버튼을 누릅니다.로 이동합니다.



화면에 지금까지 수집된 주파수 파일 패킷의 백분율이 표시됩니다.



주파수 파일 대기 중- 다운로드



Connect Plus 무전기에 일부 파일만 완료된 이전의 OTA 네트워크 주파수 파일 전송이 있는 경우 내부 타이머가 만료되면 무전기가 자동으로 파일 전송(계속 진행되고 있는 경우)에 다시 참가합니다. 이 내부 타이머가 만료되기 이전에 현재 진행 중인 네트워크 주파수 파일 전송에 무전기를 다시 참여하게 하려면 아래 설명된 대로 다운로드 옵션을 사용합니다.



1  버튼을 눌러 메뉴에 액세스합니다.을 누릅니다.

2  또는  을 눌러 유틸리티 및 선택하려면  버튼을 누릅니다.로 이동합니다.

3  또는  을 눌러 무전기 정보 및 선택하려면  버튼을 누릅니다.로 이동합니다.

4  또는  을 눌러 업데이트 및 선택하려면  버튼을 누릅니다.로 이동합니다.

5  또는  을 눌러 주파수 및 선택하려면  버튼을 누릅니다.로 이동합니다.

6  또는  을 눌러 다운로드 및 선택하려면  버튼을 누릅니다.로 이동합니다.

현재 다운로드 불가능	다운로드할 수 없음
현재 다운로드 가능	다운로드 시작

7 다음 중 하나를 수행합니다.

- 다운로드를 시작하려면 예를 선택하고 누릅니다.
- 아니요를 선택하고 눌러 이전 메뉴로 돌아갑니다.



GNSS 정보 확인



무전기에 다음과 같은 GNSS 정보를 표시합니다.



- 위도
- 경도
- 고도



- 방향
- 속도
- HDOP(Horizontal Dilution of Precision)
- 위성 수
- 버전

1  버튼을 눌러 메뉴에 액세스합니다.을 누릅니다.

2  또는  을 눌러 유틸리티 및 선택하려면  버튼을 누릅니다.로 이동합니다.

3  또는  을 눌러 무전기 정보 및 선택하려면  버튼을 누릅니다.로 이동합니다.

4  또는  버튼을 눌러 GNSS 정보 및 선택하려면  버튼을 누릅니다.로 이동합니다.



5  또는  버튼을 눌러 필요한 항목으로 이동하고 선택하려면  버튼을 누릅니다..
디스플레이에 요청한 GNSS 정보가 표시됩니다.



GNSS에 대한 자세한 내용은 [GNSS 켜기 또는 끄기 페이지의 307](#) 을 참조하십시오.



기업 Wi-Fi 인증서 세부 정보 보기

선택한 기업 Wi-Fi 인증서의 세부 정보를 볼 수 있습니다.

1  버튼을 눌러 메뉴로 이동합니다.

2  또는  버튼을 눌러 유틸리티로 이동합니다.  버튼을 눌러 선택합니다.

3  또는  버튼을 눌러 인증서 메뉴로 이동합니다.  버튼을 눌러 선택합니다.
✓가 준비된 인증서 옆에 나타납니다.

- 4  또는  버튼을 눌러 필요한 인증서로 이동합니다.  버튼을 눌러 선택합니다.
-

무전기에 인증서의 전체 세부 정보가 표시됩니다.



주의:

인증서가 준비되지 않은 경우, 디스플레이에는 상태만 표시됩니다.

기타 시스템

이 시스템의 무전기 사용자가 사용할 수 있는 기능은 이 장에 나와 있습니다.

PTT(Push-To-Talk) 버튼

Push-To-Talk(PTT) 버튼은 두 가지 기본 용도로 사용됩니다.

- 호출 중인 경우에는 **PTT** 버튼을 누르면 호출 중인 다른 무전기에 전송할 수 있습니다. **PTT** 버튼을 누르면 마이크가 활성화됩니다.
- 호출 중이 아닌 동안에는 **PTT** 버튼이 새 호출을 전송하는 데 사용됩니다(참조).

PTT 버튼을 길게 눌러 응답합니다. 상대방의 말을 들으려면 **PTT** 버튼을 놓습니다.

통화 허가음 또는 **PTT** 사이드톤이  활성화되어 있는 경우, 대화하기 전에 짧은 경보음이 끝날 때까지 기다립니다.

 호출 중 무전기에서 채널 프리 표시 기능이 활성화된 경우(대리점에서 프로그래밍한 경우), 호출 중에 대상 무전기(호출을 수신 중인 무전기)에서 **PTT** 버튼을 놓으면 채널이 사용 가능하여 응답할 수 있음을 나타내는 짧은 경보음이 울립니다.

 호출이 중단된 경우 통화 금지 연속음이 계속 들립니다. 통화 금지 연속음이 계속 들리면 **PTT** 버튼을 놓아야 합니다.

프로그래밍 가능 버튼

버튼 누름 지속 시간에 따라 대리점에서 프로그래밍 가능 버튼을 무전기 기능의 바로가기로 프로그래밍할 수 있습니다.

짧게 누르기

눌렀다 빨리 놓습니다.

길게 누르기

프로그래밍된 지속 시간 동안 누른 상태로 유지합니다.



주의:

비상 버튼의 프로그래밍된 지속 시간에 대한 자세한 내용은 **비상 작동 페이지의 398**을 참조하십시오.

지정 가능한 무전기 기능

다음 무전기 기능을 프로그래밍 가능 버튼에 지정할 수 있습니다.

오디오 환경

사용자가 무전기 작동 환경을 선택할 수 있습니다.

오디오 프로필

사용자가 원하는 오디오 프로필을 선택할 수 있습니다.

Bluetooth® 오디오 스위치

무전기 내부 스피커와 외부 Bluetooth 사용 액세스리 간에 오디오 라우팅을 전환합니다.

Bluetooth 연결

Bluetooth 찾기 및 연결 작업을 시작합니다.

Bluetooth 연결 해제

무전기와 Bluetooth 사용 장치 간의 기존 Bluetooth 연결을 모두 종료합니다.

Bluetooth 검색 가능

무전기가 Bluetooth 검색 가능 모드로 전환될 수 있습니다.

호출 정보

연락처 목록으로 직접 이동하여 호출 정보를 보낼 수 있는 연락처를 선택할 수 있습니다.

착신 전환

착신 전환을 켜거나 끕니다.

호출 목록

호출 목록을 선택합니다.

채널 안내

현재 채널에 대한 존 및 채널 안내 음성 메시지를 재생합니다.

연락처

연락처 목록으로 직접 이동할 수 있습니다.

비상

프로그래밍에 따라 비상 알람 또는 호출을 시작하거나 취소합니다.

외부 공용 주소(PA)

연결된 PA 스피커 증폭기와 무전기의 내부 PA 시스템 사이의 오디오 라우팅을 켜거나 끕니다.

실내 위치

실내 위치를 켜거나 끕니다.

지능형 오디오

지능형 오디오를 켜거나 끕니다.

매뉴얼 다이얼

가입자 ID를 입력하여 개별 호출을 시작합니다.

수동 사이트 로밍

수동 사이트 검색을 시작합니다.

마이크 AGC

내부 마이크 AGC(자동 게인 제어)를 켜거나 끕니다.

모니터

선택한 채널의 작동을 모니터링합니다.

⁷ Capacity Plus에는 적용되지 않습니다.

알림

알림 목록으로 직접 이동할 수 있습니다.

방해 채널 삭제⁷

스캔 목록에서 원하지 않는 채널(선택한 채널 제외)을 일시적으로 제거합니다. 선택한 채널은 스캔이 시작되는 사용자가 선택한 존 또는 채널 조합을 말합니다.

원터치 액세스 

미리 정의된 개별 호출, 전화 호출 또는 그룹 호출, 호출 경보, 단축 문자 메시지, 또는 홈 되돌리기를 바로 시작합니다.

옵션 보드 기능

옵션 보드 사용 채널에 대해 옵션 보드 기능을 켜거나 끕니다.

7지속적인 모니터

기능이 비활성화될 때까지 모든 무전기 트래픽에 대해 선택한 채널을 모니터합니다.

전화 

전화 연락처 목록으로 직접 이동할 수 있습니다.

개인 정보 보호 

프라이버시 기능을 켜거나 끕니다.

공용 주소(PA)

무전기의 내부 PA 시스템을 켜거나 끕니다.

무전기 별칭 및 ID

무전기 별칭 및 ID를 제공합니다.

무전기 점검 

무전기가 시스템에서 활성화되었는지 여부를 확인합니다.

무전기 비활성화 

대상 무전기를 원격으로 비활성화할 수 있습니다.

무전기 복구 

대상 무전기를 원격으로 활성화할 수 있습니다.

원격 모니터링

아무런 표시 없이 대상 무전기의 마이크를 켭니다.

중계기/토크어라운드⁷

중계기 사용과 다른 무전기와의 직접 통신 간을 전환합니다.

홈 채널 재설정

새 홈 채널을 설정합니다.

무음 홈 채널 미리 알림

홈 채널 미리 알림을 음소거합니다.

스캔⁸

스캔 기능을 켜거나 끕니다.

사이트 정보

Capacity Plus 다중 사이트의 현재 사이트 이름 및 ID가 표시됩니다.

음성 안내가 활성화되어 있으면 현재 사이트에 대한 사이트 안내 음성 메시지를 재생합니다.

사이트 잠금⁷

사이트 잠금을 켜면 무전기가 현재 사이트만 검색합니다. 사이트 잠금을 끄면 무전기가 현재 사이트에 추가로 다른 사이트를 검색합니다.

텔레메트리 측정 제어

로컬 또는 원격 무전기에서 출력 편을 제어합니다.

문자 메시지

문자 메시지 메뉴를 선택합니다.

송신 중단 리모트 디키

진행 중인 호출(중단 가능)을 중지하여 채널을 사용 가능한 상태로 만듭니다.

트릴 강화

트릴 강화를 켜거나 끕니다.

음성 안내 켜기/끄기

음성 안내를 켜거나 끕니다.

음성 활성화 송신(VOX)

VOX를 켜거나 끕니다.

Wi-Fi

Wi-Fi를 켜거나 끕니다.

존 선택

존 목록에서 선택할 수 있습니다.

지정 가능한 설정 또는 유틸리티 기능

다음 무전기 설정 또는 유틸리티 기능을 프로그래밍 가능 버튼에 지정할 수 있습니다.

톤/경보

전체 톤과 경보를 켜거나 끕니다.

백라이트

디스플레이 백라이트를 켜거나 끕니다.

채널 조정

프로그래밍에 따라 채널을 이전 채널 또는 다음 채널로 변경합니다.

⁸ Capacity Plus 단일 사이트에는 적용되지 않습니다.

디스플레이 모드

주간/야간 디스플레이 모드를 켜거나 끕니다.



출력 수준

전송 전력 레벨을 높게 설정하거나 낮게 설정합니다.

프로그래밍된 기능에 액세스

다음 절차에 따라 무전기에서 프로그래밍된 기능에 액세스합니다.

- 1 다음 중 하나를 수행합니다.
 - 프로그래밍된 버튼을 누릅니다. 단계 3로 진행합니다.
 -  버튼을 눌러 메뉴로 이동합니다.

- 2  또는  버튼을 눌러 메뉴 기능으로 이동하고  버튼을 눌러 기능을 선택하거나 하위 메뉴로 진입합니다.

- 3 다음 중 하나를 수행합니다.
 - 이전 화면으로 돌아가려면  버튼을 누릅니다.

- 홈 화면으로 돌아가려면  버튼을 길게 누릅니다.

일정 시간 사용하지 않으면 무전기에서 메뉴가 자동으로 종료되고 홈 화면으로 돌아갑니다.

메뉴 탐색 버튼은 키패드 마이크에서도 사용할 수 있습니다. 키패드 마이크 버튼 페이지의 33을 참조하십시오.

상태 표시기

이 장에서는 무전기에 사용되는 상태 표시등과 신호음을 설명합니다.

아이콘

무전기의 LCD(Liquid Crystal Display)에 무전기 상태, 텍스트 항목 및 메뉴 항목이 표시됩니다.







표 9: 디스플레이 아이콘







다음 아이콘은 무전기 디스플레이 상단의 상태 표시줄에 표시되는 아이콘입니다. 아이콘은 모양 또는 사용 순서와 채널 별로 맨 왼쪽에 배열됩니다.

	<p>BeiDou에서만 사용 가능⁹</p> <p>BeiDou 전용 기능이 활성화되어 있습니다. 고정 위치를 사용할 수 있는 경우 아이콘이 켜진 상태로 유지됩니다.</p>
	<p>Bluetooth 연결됨</p> <p>Bluetooth 기능이 활성화되어 있습니다. 원격 Bluetooth 장치가 연결되어 있으면 이 아이콘은 켜진 상태로 유지됩니다.</p>

	<p>Bluetooth 연결 안됨</p> <p>Bluetooth 기능은 활성화되어 있지만 원격 Bluetooth 장치가 연결되어 있지 않습니다.</p>
	<p>호출 목록</p> <p>무전기 호출 목록입니다.</p>
	<p>연락처</p> <p>무전기 연락처를 사용할 수 있습니다.</p>
	<p>비상</p> <p>무전기가 비상 모드에 있습니다.</p>
	<p>유연한 수신 목록</p> <p>유연한 수신 목록을 사용합니다.</p>
	<p>GNSS 사용 가능</p> <p>GNSS 기능이 활성화되어 있습니다. 고정 위치를 사용할 수 있는 경우 아이콘이 켜진 상태로 유지됩니다.</p>
	<p>GNSS 사용 불가</p> <p>GNSS 기능이 활성화되어 있지만 위성에서 데이터가 수신되지 않습니다.</p>

⁹ XiR M8660i/XiR M8668i/CM7668i에만 적용 가능.

	대용량 데이터 무선기에서 대용량 데이터를 수신 중이며 채널이 사용 중입니다.
	실내 위치 기능¹⁰ 실내 위치 상태가 켜져 있고 사용 가능합니다.
	실내 위치 사용 불가능¹⁰ 실내 위치 상태가 켜져 있지만 Bluetooth 비활성 상태 또는 Bluetooth가 비콘 스캔을 일시 중지하여 사용할 수 없습니다.
	메시지 수신 메시지입니다.
	모니터 선택한 채널을 모니터링하는 중입니다.
	음소거 모드 음소거 모드가 활성화되고 스피커가 음소거됩니다.

	알림 알림 목록에 하나 이상의 부재 중 이벤트가 있습니다.
	옵션 보드 옵션 보드가 활성화되어 있습니다. (옵션 보드 지원 모델에만 해당)
	옵션 보드 비활성화 옵션 보드가 비활성화되어 있습니다.
	무선 프로그래밍 지연 타이머 무선기가 자동으로 재시작되기 전까지 남은 시간을 나타냅니다.
	RSSI(Received Signal Strength Indicator, 수신 신호 강도 표시기) 표시되는 막대 수는 무선 신호 강도를 나타냅니다. 막대 4개는 가장 강력한 신호를 의미합니다. 이 아이콘은 수신하는 동안에만 표시됩니다.
	응답 금지 응답 금지가 활성화되었습니다.

¹⁰ 최신 소프트웨어 및 하드웨어와 모델에만 적용됩니다.

	벨소리만 벨 모드를 사용합니다.
	스캔¹¹ 스캔 기능이 활성화되어 있습니다.
	스캔-우선순위 1¹¹ 무전기가 우선 1로 지정된 채널/그룹에서 동작을 감지합니다.
	스캔-우선순위 2¹¹ 무전기가 우선 2로 지정된 채널/그룹에서 동작을 감지합니다.
	보안 프라이버시 기능이 활성화되어 있습니다.
	로그인 무전기가 원격 서버에 로그인되었습니다.

	로그아웃 무전기가 원격 서버에서 로그아웃되었습니다.
	무음 무음 모드를 사용합니다.
	사이트 로밍¹² 사이트 로밍 기능이 활성화되어 있습니다.
	토크어라운드¹¹ 중계기가 없는 경우 무전기가 직접 무전기 간 통신으로 구성됩니다.
	신호음 비활성화 신호음이 꺼져 있습니다.
	비보안 프라이버시 기능이 비활성화되어 있습니다.

¹¹ Capacity Plus에는 적용되지 않습니다.

¹² Capacity Plus 단일 사이트에는 적용되지 않습니다.

	보트 스캔 보트 스캔 기능이 활성화되어 있습니다.
	Wi-Fi 우수¹³ Wi-Fi 신호가 우수합니다.
	Wi-Fi 양호¹³ Wi-Fi 신호가 양호합니다.
	Wi-Fi 평균¹³ Wi-Fi 신호가 평균입니다.
	Wi-Fi 불량¹³ Wi-Fi 신호가 약합니다.
	Wi-Fi 사용할 수 없음¹³ Wi-Fi 신호를 사용할 수 없습니다.

표 10: 고급 메뉴 아이콘

다음 아이콘은 메뉴 항목 옆에 표시되어 두 옵션 중에서 선택할 수 있도록 하거나 두 옵션을 제공하는 하위 메뉴가 있음을 나타냅니다.





	확인란(선택됨) 옵션이 선택되었음을 나타냅니다.
	확인란(비어 있음) 옵션이 선택되어 있지 않음을 나타냅니다.
	단색 검은색 상자 하위 메뉴가 있는 메뉴 항목에 대해 선택된 옵션을 나타냅니다.

표 11: Bluetooth 장치 아이콘

다음 아이콘은 장치 유형을 나타내는 데 사용할 수 있는 Bluetooth 사용 장치 목록의 항목 옆에도 나타납니다.



	Bluetooth 오디오 장치 헤드셋과 같은 Bluetooth 사용 오디오 장치입니다.
---	--

¹³ XiR M8668i/CM7668i에만 적용됨.

	<p>Bluetooth 데이터 장치 스캐너와 같은 Bluetooth 사용 데이터 장치입니다.</p>
	<p>Bluetooth PTT 장치 POD(PTT 전용 장치)와 같은 Bluetooth 사용 PTT 장치입니다.</p>

표 12: 호출 아이콘

다음 아이콘은 호출 중에 디스플레이에 나타납니다. 이 아이콘은 연락처 목록에 표시되어 별칭이나 ID 유형을 나타내기도 합니다.

	<p>Bluetooth로 PC 호출 Bluetooth로 PC 호출이 진행 중임을 나타냅니다. 연락처 목록에서는 Bluetooth로 PC 호출 별칭(이름) 또는 ID(번호)를 나타냅니다.</p>
	<p>발신 호출 디스패치 호출 연락처 유형은 타사 문자 메시지 서버를 사용하여 디스패치 PC에 문자 메시지를 보내는 데 사용됩니다.</p>











	<p>그룹 호출/전체 호출 진행 중인 그룹 호출 또는 전체 호출을 나타냅니다. 연락처 목록에서는 그룹 별칭(이름) 또는 ID(번호)를 나타냅니다.</p>
	<p>개별 호출 진행 중인 개별 호출을 나타냅니다. 연락처 목록에서는 가입자 별칭(이름) 또는 ID(번호)를 나타냅니다.</p>
	<p>그룹 호출/전체 호출로 전화 통화 그룹 호출 또는 전체 호출로 전화 통화가 진행 중임을 나타냅니다. 연락처 목록에서는 그룹 별칭(이름) 또는 ID(번호)를 나타냅니다.</p>
	<p>개별 호출로 전화 통화 개별 호출로 전화 통화가 진행 중임을 나타냅니다. 연락처 목록에서는 통화 별칭(이름) 또는 ID(번호)를 나타냅니다.</p>

표 13: 작업 티켓 아이콘

다음 아이콘이 작업 티켓 폴더의 디스플레이에 잠시 나타납니다.

	모든 작업 나열된 모든 작업을 나타냅니다.
	새 작업 새 작업을 나타냅니다.
	진행 중 작업을 전송 중입니다. 이것은 작업 티켓 전송 실패 또는 전송 성공의 표시 전에 나타납니다.
	전송 실패 작업을 보낼 수 없습니다.
	전송 성공 작업이 성공적으로 전송되었습니다.
	우선 순위 1 작업의 우선순위 레벨 1을 나타냅니다.



	우선 순위 2 작업의 우선순위 레벨 2을 나타냅니다.
	우선 순위 3 작업의 우선순위 레벨 3을 나타냅니다.

표 14: 미니 알림 아이콘

작업을 수행하면 다음 아이콘이 디스플레이에 잠시 나타납니다.



	전송 실패(부정) 작업이 실패했습니다.
	전송 성공(긍정) 작업이 성공적으로 수행되었습니다.
	진행 중인 전송(전환) 전송 중입니다. 이 아이콘은 전송 성공 또는 전송 실패를 나타내기 전에 표시 됩니다.

표 15: 보낸 문자함 아이콘

다음 아이콘은 보낸 문자함 폴더에서 디스플레이의 오른쪽 상단에 표시됩니다.

	<p>진행 중 가입자 별칭 또는 ID로의 문자 메시지가 전송 대기 중이며 승인을 기다리고 있습니다. 그룹 별칭 또는 ID로 문자 메시지가 전송 대기 중입니다.</p>
	<p>개별 또는 그룹 메시지 읽음 문자 메시지를 읽었습니다.</p>
	<p>개별 또는 그룹 메시지 읽지 않음 읽지 않은 문자 메시지가 있습니다.</p>
	<p>전송 실패 문자 메시지를 전송하지 못했습니다.</p>

전송 성공
문자 메시지를 성공적으로 보냈습니다.

LED 표시

LED 표시등은 무전기의 작동 상태를 나타냅니다.

빨간색으로 깜박임

전원을 켤 때 자가 테스트에 실패했습니다.

무전기가 비상 전송을 수신 중입니다.

무전기가 배터리 부족 상태에서 전송 중입니다.

무전기에 ARTS(Auto-Range Transponder System)가 구성된 경우 무전기가 통화권 범위를 이탈했습니다.

음소거 모드가 활성화되었습니다.

녹색으로 켜져 있음

무전기 전원이 켜지고 있습니다.

무전기가 전송 중입니다.

무전기가 호출 경보 또는 비상 전송을 수신 중입니다.

녹색으로 깜박임

무전기가 호출 또는 데이터를 수신 중입니다.

무전기에서 무선 프로그래밍 전송을 검색 중입니다.

무전기에서 무선 동작을 감지하고 있습니다.



주의:

디지털 프로토콜의 특성에 따라 이 동작은 무전기의 프로그래밍된 채널에 영향을 줄 수도 있고 주지 않을 수도 있습니다.

무전기가 **Capacity Plus**에서 무선으로 동작을 감지 중일 때는 LED 표시가 없습니다.

녹색으로 2회 깜박임

무전기가 프라이버시 활성화 호출 또는 데이터를 수신 중입니다.

노란색으로 켜져 있음

무전기가 컨벤셔널 채널을 모니터하고 있습니다.

무전기가 **Bluetooth** 검색 가능 모드에 있습니다.

노란색으로 깜박임

무전기가 동작을 스캔하고 있습니다.

무전기가 호출 경보에 응답해야 합니다.

무전기에 유연한 수신 목록이 활성화되어 있습니다.

모든 **Capacity Plus** 다중 사이트 채널이 사용 중입니다.

노란색으로 2회 깜박임

무전기에 자동 로밍이 활성화되었습니다.

무전기에서 새 사이트를 능동 검색하고 있습니다.

무전기가 그룹 호출 경보에 응답해야 합니다.

무전기가 잠겨 있습니다.

Capacity Plus에서 무전기가 중계기에 연결되어 있지 않습니다.

모든 **Capacity Plus** 채널이 사용 중입니다.

신호음

다음은 무전기 스피커를 통해 울리는 신호음입니다.



고음



저음

상태 표시음

상태 표시음은 작업을 수행한 후 무전기의 상태를 청각적으로 나타냅니다.



선택음



해제음

가청음

가청음은 무전기의 상태 또는 수신된 데이터에 대한 무전기의 응답을 청각적으로 나타냅니다.



연속음

단조로운 톤입니다. 종료될 때까지 계속 울립니다.



주기적 신호음

무전기에 설정된 시간에 따라 주기적으로 톤이 울립니다. 톤이 자체적으로 시작, 중지 및 반복됩니다.



반복음

사용자가 종료할 때까지 자체적으로 반복되는 단일음입니다.



일시적 음

무전기에 설정된 시간에 따라 톤이 짧게 한 번 울립니다.

컨벤셔널 아날로그 및 디지털 모드

무전기의 각 채널을 컨벤셔널 아날로그 채널이나 컨벤셔널 디지털 채널로 구성할 수 있습니다.

채널 로커를 사용하여 아날로그 또는 디지털 채널로 전환합니다.

디지털 모드에서 아날로그 모드로 전환하면 특정 기능을 사용할 수 없습니다. 디지털 기능에 해당하는 아이콘이 "회색"으로 표시되어 이 변경 사항을 나타냅니다. 비활성화된 기능은 메뉴에서 숨겨져 있습니다.

또한 무전기에는 아날로그 모드와 디지털 모드 모두에서 사용할 수 있는 기능도 있습니다. 각 기능의 작동 방식에 따른 사소한 차이는 무전기 성능에 영향을 주지 **않습니다**.



주의:

무전기는 듀얼 모드 스캔 중에도 디지털 모드와 아날로그 모드 간에 전환됩니다. 자세한 내용은 **스캔 페이지의 379** 부분을 참조하십시오.

아이콘 정보

이 설명서에서 표시된 아이콘은 컨벤셔널 아날로그 모드 또는 컨벤셔널 디지털 모드 지원 기능 또는 키패드 지원 마이크가 있어야 사용 가능한 기능을 나타내는 데 사용됩니다.



컨벤셔널 **아날로그 모드 전용** 기능을 나타냅니다.



컨벤셔널 디지털 모드 전용 기능을 나타냅니다.

컨벤셔널 아날로그 및 디지털 모드에서 모두 사용되는 기능인 경우에는 모든 아이콘이 표시되지 않습니다.

IP Site Connect

이 기능은 무전기가 인터넷 프로토콜(IP) 네트워크를 사용하여 다양한 가용 사이트에 연결함으로써 단일 사이트 범위를 벗어나 종래의 통신을 확장할 수 있도록 해줍니다. 이것을 컨벤셔널 멀티 사이트 모드라고 합니다.

무전기가 한 사이트 범위에서 벗어나 다른 사이트 범위로 이동하는 경우 해당 무전기는 호출 또는 데이터 전송을 보내거나 받기 위해 새 사이트의 중계기에 연결됩니다. 설정에 따라 이 연결은 자동으로 또는 수동으로 수행됩니다.

자동 사이트 검색의 경우 무전기는 현재 사이트로부터의 신호가 약하거나 무전기가 현재 사이트로부터의 신호를 감지할 수 없을 때 모든 사용 가능한 사이트를 스캔합니다. 그런 다음 무전기는 강도가 가장 높은 RSSI(Received Signal Strength Indicator, 수신 신호 강도 표시기) 값으로 해당 중계기에 고정됩니다.

수동 사이트 검색의 경우 무전기는 로밍 목록에서 현재 범위에 있는 다음 사이트(신호 강도가 가장 높지 않을 수 있음)를 검색한 후 중계기에 고정됩니다.



주의:

각 채널은 스캔 또는 로밍 중 하나만 활성화할 수 있습니다. 동시에 둘 다 활성화할 수는 없습니다.

이 기능이 활성화된 채널은 특정 로밍 목록에 추가할 수 있습니다. 무전기는 자동 로밍 작동 중에 로밍 목록의 채널을 검색하여 최상의 사이트를 찾습니다. 로밍 목록은 최대 16개 채널(선택한 채널 포함)을 지원합니다.



주의:

로밍 목록에 항목을 수동으로 추가하거나 삭제할 수 없습니다. 자세한 내용은 대리점이나 시스템 관리자에게 문의하십시오.

Capacity Plus--단일 사이트

Capacity Plus 단일 사이트는 수백 명의 사용자와 최대 254개의 그룹을 지원하기 위해 채널 풀을 사용하는 MOTOTRBO 무전기 시스템의 단일 사이트 트렁크 구성입니다. 무전기는 중계기 모드에서 이 기능을 통해 프로그래밍된 가용 채널 수를 효율적으로 활용할 수 있습니다.

프로그래밍 가능 버튼을 눌러 Capacity Plus 단일 사이트에 적용되지 않는 기능에 액세스하려고 하면 해제음이 울립니다.

또한 무전기에는 컨벤셔널 디지털 모드, IP Site Connect 및 Capacity Plus에서 사용할 수 있는 기능도 있습니다. 그러나 각 기능의 작동 방식에 따른 사소한 차이는 무전기 성능에 영향을 주지 않습니다.

이 구성에 대한 자세한 내용은 대리점이나 시스템 관리자에게 문의하십시오.

Capacity Plus 다중 사이트

Capacity Plus 다중 사이트는 Capacity Plus와 IP Site Connect 구성의 장점을 모두 결합한 MOTOTRBO 무전기 시스템의 다중 채널 트렁크 구성입니다.

Capacity Plus 다중 사이트는 무전기가 IP 네트워크를 통해 연결되는 다양한 가용 사이트에 연결함으로써 단일 사이트 범위를 벗어나 트렁크 통신을 확장할 수 있도록 해줍니다. 각 가용 사이트에서 지원되는 프로그래밍된 통합 가용 채널 수를 효율적으로 활용하여 용량을 늘릴 수도 있습니다.

무전기가 한 사이트 범위에서 벗어나 다른 사이트 범위로 이동하는 경우 해당 무전기는 호출 또는 데이터 전송을 보내거나 받기 위해 새 사이트의 중계기에 연결됩니다. 설정에 따라 이 연결은 자동으로 또는 수동으로 수행됩니다.

자동으로 연결하도록 설정된 무전기는 현재 사이트로부터의 신호가 약하거나 무전기가 현재 사이트로부터의 신호를 감지할 수 없는 경우 모든 사용 가능한 사이트를 스캔합니다.

그런 다음 무전기는 강도가 가장 높은 RSSI 값과 함께 해당 중계기에 고정됩니다.

수동 사이트 검색의 경우 무전기는 로밍 목록에서 현재 범위에 있는 다음 사이트(신호 강도가 가장 높지 않을 수 있음)를 검색한 후 그 사이트에 고정됩니다.

Capacity Plus 다중 사이트가 활성화된 채널은 특정 로밍 목록에 추가할 수 있습니다. 무전기는 자동 로밍 작동 중에 채널을 검색하여 최상의 사이트를 찾습니다.



주의:

로밍 목록에 항목을 수동으로 추가하거나 삭제할 수 없습니다. 자세한 내용은 대리점이나 시스템 관리자에게 문의하십시오.

Capacity Plus 단일 사이트와 유사하게, Capacity Plus 다중 사이트에 적용되지 않는 기능 아이콘은 메뉴에서 사용할 수 없습니다. 프로그래밍 가능 버튼을 눌러 Capacity Plus 다중 사이트에 적용되지 않는 기능에 액세스하려고 하면 해제는 이 유효합니다.

존 및 채널 선택

이 장에서는 무전기에서 존 또는 채널을 선택하는 방법에 대해 설명합니다. 존은 채널 그룹입니다.



무전기는 최대 99 채널 및 2 개의 존(각 존당 최대 99 개 채널)을 지원합니다.

각 채널은 서로 다른 기능으로 프로그래밍되거나 다른 사용자 그룹을 지원할 수 있습니다.



존 선택

다음 절차에 따라 무전기에서 원하는 존을 선택합니다.

- 다음 중 하나를 수행합니다.
 - 프로그래밍된 **존 선택** 버튼을 누릅니다. 단계 3로 진행합니다.
 -  버튼을 눌러 메뉴로 이동합니다.

-  또는  버튼을 눌러 존으로 이동합니다.
 버튼을 눌러 선택합니다.

디스플레이에  및 현재 존이 표시됩니다.



-  또는  버튼을 눌러 원하는 존으로 이동합니다.  버튼을 눌러 선택합니다.

디스플레이에 <존> 선택 완료가 잠시 표시된 후 선택한 존 화면으로 돌아갑니다.

별칭 검색을 사용하여 존 선택

다음 절차에 따라 별칭 검색을 사용하여 무전기에서 원하는 존을 선택합니다.

-  버튼을 눌러 메뉴로 이동합니다.

-  또는  버튼을 눌러 존으로 이동합니다.
 버튼을 눌러 선택합니다.

디스플레이에  및 현재 존이 표시됩니다.

- 원하는 별칭의 첫 문자를 입력합니다.
디스플레이에 커서가 깜박입니다.

- 원하는 별칭의 나머지 문자를 입력합니다.

별칭 검색은 대소문자를 구분하지 않습니다. 같은 이름의 항목이 두 개 이상 있으면 디스플레이에는 목록에 첫 번째로 나열된 항목이 표시됩니다.

첫 번째 텍스트 줄에 입력한 문자가 표시됩니다. 다음 텍스트 줄에는 간략히 나열된 검색 결과가 표시됩니다.

5  버튼을 눌러 선택합니다.

디스플레이에 <준> 선택 완료가 잠시 표시된 후 선택한 준 화면으로 돌아갑니다.

채널 선택

다음 절차에 따라 준을 선택한 후 무전기에서 원하는 채널을 선택합니다.

다음 중 하나를 수행합니다.

- 위로 스크롤/아래로 스크롤 버튼을 누릅니다.
- 볼륨/채널 노브를 사용합니다.
- 프로그래밍된 채널 조정 버튼을 누릅니다.

호출

이 장에서는 통화를 수신, 응답, 발신 및 중지하는 방법을 설명합니다.

채널을 선택하고 나면 다음 기능 중 하나를 사용하여 가입자 별칭 또는 ID, 그룹 별칭 또는 ID를 선택할 수 있습니다.

별칭 검색

이 방법은 그룹 호출, 개별 호출 및 전체 호출 전용으로 키패드 마이크와 함께 사용됩니다.

연락처 목록

이 방법을 사용하면 연락처 목록으로 직접 이동할 수 있습니다.

매뉴얼 다이얼(연락처 사용)

이 방법은 개별 호출 및 전화 통화 전용으로 키패드 마이크와 함께 사용됩니다.

프로그래밍된 숫자 키

이 방법은 그룹 호출, 개별 호출 및 전체 호출 전용으로 키패드 마이크와 함께 사용됩니다.



주의:

하나의 숫자 키에는 별칭 또는 ID를 하나만 할당할 수 있지만 하나의 별칭 또는 ID에는 숫자 키를 두 개 이상 연결할 수 있습니다. 키패드 마이크의 모든 숫자 키를 지정할 수 있습니다. 자세한 내용은 [프로그래밍 가능 숫자 키에 항목 할당 페이지의 383](#) 부분을 참조하십시오.

프로그래밍된 원터치 액세스 버튼

이 방법은, 개별 호출 및 전화 통화 전용입니다.

프로그래밍된 버튼을 짧게 또는 길게 눌러 한 ID만 원터치 액세스 버튼에 지정할 수 있습니다. 무전기에 여러 개의 원터치 액세스 버튼을 프로그래밍할 수 있습니다.

프로그래밍 가능 버튼

이 방법은 전화 통화 전용(참조)입니다.

블룸/채널 선택기 노브

이 방법은 수동으로 가입자 별칭 또는 ID, 그룹 별칭 또는 ID를 선택합니다.

무전기가 발신 중이면 녹색 LED가 켜지고 무전기가 수신 중이면 녹색으로 깜박입니다.



주의:

무전기가 송신 중이면 녹색 LED가 켜지고 무전기가 프라이버시 활성화 호출을 수신 중이면 녹색으로 2회 깜박입니다.

프라이버시 활성화 호출의 스크램블을 풀려면 발신 무전기(수신 중인 호출을 보낸 무전기)와 동일한 프라이버시 키 또는 키 값과 키 ID(대리점에서 프로그래밍함)가 무전기에 있어야 합니다.

자세한 내용은 [개인 정보 보호 페이지의 433](#) 부분을 참조하십시오.

그룹 호출

그룹 사용자로부터 호출을 송수신하려면 무전기가 해당 그룹의 일부로 구성되어야 합니다.

그룹 호출 전송

다음 절차에 따라 무전기에서 그룹 호출을 전송합니다.

- 1 다음 중 하나를 수행합니다.
 - 활성화 그룹 별칭 또는 ID가 있는 채널을 선택합니다.
 - 프로그래밍된 **원터치 액세스** 버튼을 누릅니다.

- 2 **PTT** 버튼을 눌러 전화를 전송합니다.

녹색 LED가 켜집니다. 디스플레이에 **그룹 호출** 아이콘과 그룹 호출 별칭이 표시됩니다.

- 3 상대방의 말을 들으려면 **PTT** 버튼을 놓습니다.

대상 무전기가 응답하면 녹색 LED가 켜집니다. 디스플레이에 **그룹 호출** 아이콘, 그룹 별칭 또는 ID, 송신 무전기 별칭 또는 ID가 표시됩니다.



- 4  채널 프리 표시 기능이 활성화된 경우 발신 무전기에서 **PTT** 버튼을 놓으면 채널이 사용 가능하여 응답할 수 있음을 나타내는 짧은 경보음이 울립니다. **PTT** 버튼을 눌러 호출에 응답합니다.



미리 정해진 시간 동안 음성 동작이 없으면 호출이 종료됩니다. 무전기가 호출 시작 전 화면으로 돌아갑니다.

연락처 목록을 사용하여 그룹 호출 전송

다음 절차에 따라 연락처 목록을 사용하여 무전기에서 그룹 호출을 전송합니다.

- 1  버튼을 눌러 메뉴로 이동합니다.

- 2  또는  버튼을 눌러 연락처로 이동합니다.
 버튼을 눌러 선택합니다.

- 3  또는  버튼을 눌러 원하는 별칭 또는 ID로 이동합니다.  버튼을 눌러 선택합니다.

- 4 **PTT** 버튼을 눌러 전화를 전송합니다.
녹색 LED가 켜집니다.

- 5 상대방의 말을 들으려면 **PTT** 버튼을 놓습니다.

그룹 내 모든 사용자가 응답하면 녹색 LED가 깜박입니다. 디스플레이에 **그룹 호출** 아이콘, 별칭 또는 ID, 발신 무전기 별칭 또는 ID가 표시됩니다.

- 6  채널 프리 표시 기능이 활성화된 경우 발신 무전기에서 **PTT** 버튼을 놓으면 채널이 사용 가능하여 응답할 수 있음을 나타내는 짧은 경보음이 울립니다. **PTT** 버튼을 눌러 호출에 응답합니다.

미리 정해진 시간 동안 음성 동작이 없으면 호출이 종료됩니다.

프로그래밍 가능 숫자 키를 사용하여 그룹 호출 전송

다음 절차에 따라 프로그래밍 가능한 숫자 키를 사용하여 무전기에서 그룹 호출을 전송합니다.

- 1 홈 화면에 있는 경우 프로그래밍된 숫자 키를 길게 눌러 미리 정의된 별칭이나 ID로 이동합니다.
특정 모드에서 항목에 숫자 키를 지정할 경우 다른 모드에서 숫자 키를 길게 누르면 이 기능이 지원되지 않습니다.

항목에 숫자 키가 연결되어 있지 않으면 해제음이 울립니다.

-
- 2 PTT** 버튼을 눌러 전화를 전송합니다.
녹색 LED가 켜집니다.

-
- 3** 상대방의 말을 들으려면 **PTT** 버튼을 놓습니다.
그룹 내 모든 사용자가 응답하면 녹색 LED가 깜박입니다.

-
- 4**  채널 프리 표시 기능이 활성화된 경우 발신 무전기에서 **PTT** 버튼을 놓으면 채널이 사용 가능하여 응답할 수 있음을 나타내는 짧은 경보음이 울립니다.**PTT** 버튼을 눌러 호출에 응답합니다.

미리 정해진 시간 동안 음성 동작이 없으면 호출이 종료됩니다.무전기가 호출 시작 전 화면으로 돌아갑니다.

자세한 내용은 [프로그래밍 가능 숫자 키에 항목 할당 페이지의 383](#) 부분을 참조하십시오.

그룹 호출에 응답

그룹 사용자로부터 호출을 수신하려면 무전기가 해당 그룹의 일부로 구성되어야 합니다. 다음 절차에 따라 무전기에서 그룹 호출에 응답합니다.

그룹 호출 수신 시:

- 녹색 LED가 깜박입니다.
- 디스플레이의 오른쪽 상단에 **그룹 호출** 아이콘이 표시됩니다.
- 첫 번째 텍스트 줄에 발신자 별칭이 표시됩니다.
- 두 번째 텍스트 줄에 그룹 호출 별칭이 표시됩니다.
- 무전기 음소거가 해제되고 호출 수신 시 스피커를 통해 소리가 납니다.

1 다음 중 하나를 수행합니다.

-  채널 프리 표시 기능이 활성화된 경우 발신 무전기에서 **PTT** 버튼을 놓으면 채널이 사용 가능하여 응답할 수 있음을 나타내는 짧은 경보음이 울립니다.**PTT** 버튼을 눌러 호출에 응답합니다.

- 음성 중단 기능이 활성화된 경우 **PTT** 버튼을 누르면 발신 무전기에서 오디오가 중단되고 채널이 사용 가능한 상태가 되어 응답할 수 있게 됩니다.

녹색 LED가 켜집니다.

2 다음 중 하나를 수행합니다.

- 통화 허용 신호음(활성화된 경우)이 끝날 때까지 기다렸다가 마이크에 대고 명확히 말합니다.
- PTT** 사이드톤(활성화된 경우)이 끝날 때까지 기다렸다가 마이크에 대고 또렷하게 말합니다.

3 상대방의 말을 들으려면 **PTT** 버튼을 놓습니다.

미리 정해진 시간 동안 음성 동작이 없으면 호출이 종료됩니다.

무전기가 홈 화면에 있지 않을 때 그룹 호출을 수신하는 경우, 호출에 응답하기 전에 현재 화면에 그대로 있습니다.

응답하기 전에 발신자 별칭을 확인하려면  버튼을 길게 눌러 홈 화면으로 되돌아갑니다.

개별 호출

개별 호출은 개별 무전기 간 호출을 말합니다.

개별 호출은 두 가지 방법으로 설정할 수 있습니다. 무전기 존재 여부를 확인한 후 호출을 설정하는 유형과 호출을 즉시 설정하는 유형이 있습니다. 대리점에서 이러한 호출 유형 중 하나만 무전기에 프로그래밍할 수 있습니다.

개별 호출 전송

개별 호출을 시작하려면 무전기가 프로그래밍되어야 합니다. 이 기능이 활성화되어 있지 않을 경우 호출을 시작할 때 해제음이 울립니다. 다음 절차에 따라 무전기에서 개별 호출을 전송합니다.

개별 무전기에 액세스하려면 문자 메시지 또는 호출 정보 기능을 사용합니다. 자세한 내용은 [문자 메시지 페이지의 136](#) 또는 [호출 정보 작동 페이지의 394](#)를 참조하십시오.

1 다음 중 하나를 수행합니다.

- 가입자 별칭 또는 ID가 활성화되어 있는 채널을 선택합니다.
- 프로그래밍된 **원터치 액세스** 버튼을 누릅니다.

2 **PTT** 버튼을 눌러 전화를 전송합니다.

녹색 LED가 켜집니다. 디스플레이에 **개별 호출** 아이콘, 가입자 별칭 및 호출 상태가 표시됩니다.

3 통화 허용 신호음(활성화된 경우)이 끝날 때까지 기다렸다가 마이크에 대고 명확히 말합니다.

4 상대방의 말을 들으려면 **PTT** 버튼을 놓습니다.
대상 무전기가 응답하면 녹색 LED가 깜박입니다.



5  채널 프리 표시 기능이 활성화된 경우 발신 무전기에서 **PTT** 버튼을 놓으면 채널이 사용 가능하여 응답할 수 있음을 나타내는 짧은 경보음이 울립니다. **PTT** 버튼을 눌러 호출에 응답합니다.



미리 정해진 시간 동안 음성 동작이 없으면 호출이 종료됩니다. 신호음이 울립니다. 디스플레이에 통화 종료 표시가 표시됩니다.

연락처 목록을 사용하여 개별 호출 전송

다음 절차에 따라 연락처 목록을 사용하여 무전기에서 개별 호출을 전송합니다.

1  버튼을 눌러 메뉴로 이동합니다.

2  또는  버튼을 눌러 연락처로 이동합니다.
 버튼을 눌러 선택합니다.

3  또는  버튼을 눌러 원하는 별칭 또는 ID로 이동합니다.  버튼을 눌러 선택합니다.

4 **PTT** 버튼을 눌러 전화를 전송합니다.
녹색 LED가 켜집니다. 디스플레이에 대상 별칭이 표시됩니다.

5 통화 허용 신호음(활성화된 경우)이 끝날 때까지 기다렸다가 마이크에 대고 명확히 말합니다.

6 상대방의 말을 들으려면 **PTT** 버튼을 놓습니다.
대상 무전기가 응답하면 녹색 LED가 깜박입니다. 디스플레이에 전송 중인 사용자 별칭 또는 ID가 표시됩니다.

7  채널 프리 표시 기능이 활성화된 경우 발신 무전기에서 **PTT** 버튼을 놓으면 채널이 사용 가능하여 응답할 수 있음을 나타내는 짧은 경보음이 울립니다. **PTT** 버튼을 눌러 호출에 응답합니다.

미리 정해진 시간 동안 음성 동작이 없으면 호출이 종료됩니다. 신호음이 울립니다. 디스플레이에 통화 종료 표시가 표시됩니다.

매뉴얼 다이얼을 사용하여 개별 호출 전송



다음 절차에 따라 매뉴얼 다이얼을 사용하여 무전기에서 개별 호출을 전송합니다.

- 1 버튼을 눌러 메뉴로 이동합니다.

- 2 또는 버튼을 눌러 연락처로 이동합니다.
 버튼을 눌러 선택합니다.

- 3 또는 버튼을 눌러 매뉴얼 다이얼로 이동합니다. 버튼을 눌러 선택합니다.

- 4 또는 버튼을 눌러 무전기 번호를 선택합니다. 버튼을 눌러 선택합니다.

- 5 다음 중 하나를 수행합니다.

- 가입자 ID를 입력하고 버튼을 눌러 계속합니다.
- 이전에 연결했던 가입자 ID를 편집하고 버튼을 눌러 계속합니다.

6 PTT 버튼을 눌러 전화를 전송합니다.

녹색 LED가 켜집니다. 디스플레이에 대상 별칭이 표시됩니다.

7 통화 허용 신호음(활성화된 경우)이 끝날 때까지 기다렸다가 마이크에 대고 명확히 말합니다.

8 상대방의 말을 들으려면 PTT 버튼을 놓습니다.

대상 무전기가 응답하면 녹색 LED가 켜집니다. 디스플레이에 전송 중인 사용자 별칭 또는 ID가 표시됩니다.

9 채널 프리 표시 기능이 활성화된 경우 발신 무전기에서 PTT 버튼을 놓으면 채널이 사용 가능하여 응답할 수 있음을 나타내는 짧은 경보음이 울립니다. PTT 버튼을 눌러 호출에 응답합니다.

미리 정해진 시간 동안 음성 동작이 없으면 호출이 종료됩니다. 신호음이 울립니다. 디스플레이에 통화 종료 표시가 표시됩니다.

프로그래밍 가능 숫자 키를 사용하여 개별 호출 전송

다음 절차에 따라 프로그래밍 가능한 숫자 키를 사용하여 무전기에서 개별 호출을 전송합니다.

- 1 홈 화면에 있는 경우 프로그래밍된 숫자 키를 길게 눌러 미리 정의된 별칭이나 ID로 이동합니다.

특정 모드에서 항목에 숫자 키를 지정할 경우 다른 모드에서 숫자 키를 길게 누르면 이 기능이 지원되지 않습니다.

항목에 숫자 키가 연결되어 있지 않으면 해제음이 울립니다.

- 2 **PTT** 버튼을 눌러 전화를 전송합니다.

녹색 LED가 켜집니다. 디스플레이의 오른쪽 상단에 **개별 호출** 아이콘이 표시됩니다. 첫 번째 텍스트 줄에 발신자 별칭이 표시됩니다. 두 번째 텍스트 줄에 통화 상태가 표시됩니다.

- 3 상대방의 말을 들으려면 **PTT** 버튼을 놓습니다.

대상 무전기가 응답하면 녹색 LED가 깜박입니다. 디스플레이에 대상 별칭이 표시됩니다.

- 4  채널 프리 표시 기능이 활성화된 경우 발신 무전기에서 **PTT** 버튼을 놓으면 채널이 사용 가능하여 응답할 수 있음을 나타내는 짧은 경보음이 울립니다. **PTT** 버튼을 눌러 호출에 응답합니다.

미리 정해진 시간 동안 음성 동작이 없으면 호출이 종료됩니다. 신호음이 울립니다. 무전기가 호출 시작 전 화면으로 돌아갑니다.

자세한 내용은 [프로그래밍 가능 숫자 키에 항목 할당 페이지의 383](#) 부분을 참조하십시오.

개별 호출에 응답

다음 절차에 따라 무전기에서 개별 호출에 응답합니다.

개별 호출 수신 시:

- 녹색 LED가 깜박입니다.
- 무전기 음소거가 해제되고 호출 수신 시 스피커를 통해 소리가 납니다.

- 1 다음 중 하나를 수행합니다.

- 채널 프리 표시 기능이 활성화된 경우 발신 무전기에서 **PTT** 버튼을 놓으면 채널이 사용 가능하여 응답할 수 있음을 나타내는 짧은 정보음이 울립니다. **PTT** 버튼을 눌러 호출에 응답합니다.
- 송신 중단 리모트 디키 기능이 활성화된 경우 **PTT** 버튼을 누르면 진행 중인 호출(중단 가능)이 중지되고 채널이 사용 가능한 상태가 되어 응답할 수 있게 됩니다.

녹색 LED가 켜집니다.

2 통화 허용 신호음(활성화된 경우)이 끝날 때까지 기다렸다가 마이크에 대고 명확히 말합니다.

3 상대방의 말을 들으려면 **PTT** 버튼을 놓습니다.
미리 정해진 시간 동안 음성 동작이 없으면 호출이 종료됩니다.

전체 호출

전체 호출은 개별 무전기에서 채널의 모든 무전기로 송신되는 호출을 말합니다. 전체 호출은 사용자의 주의를 필요로 하는 중요 정보를 통보하는 데 사용됩니다. 채널상의 사용자는 전체 호출에 응답할 수 없습니다.

전체 호출 수신

전체 호출 수신 시:

- 신호음이 울립니다.
- 녹색 LED가 깜박입니다.
- 디스플레이의 오른쪽 상단에 **그룹 호출** 아이콘이 표시됩니다.
- 첫 번째 텍스트 줄에 발신자 별칭 ID가 표시됩니다.
- 두 번째 텍스트 줄에 전체 호출이 표시됩니다.
- 무전기 음소거가 해제되고 호출 수신 시 스피커를 통해 소리가 납니다.

호출을 종료하면 무전기가 전체 호출을 수신하기 전 화면으로 돌아갑니다.

전체 호출은 미리 정해진 시간 동안 기다리지 않고 끝납니다.

● 가용 채널 표시 기능이 활성화된 경우 발신 무전기에서 **PTT** 버튼을 놓으면 채널이 사용 가능함을 나타내는 짧은 정보음이 울립니다.

전체 호출에는 응답할 수 없습니다.

**주의:**

무전기에서 호출을 수신하는 동안 다른 채널로 전환하는 경우에는 전체 호출 수신이 중지됩니다. 전체 호출 중에는 호출이 끝날 때까지 메뉴 탐색이나 편집을 계속할 수 없습니다.

전체 호출 전송

전체 호출을 전송하려면 무전기가 프로그래밍되어야 합니다. 다음 절차에 따라 무전기에서 전체 호출을 전송합니다.

- 1 전체 호출 그룹 별칭 또는 ID가 활성화되어 있는 채널을 선택합니다.

- 2 **PTT** 버튼을 눌러 전화를 전송합니다.

녹색 LED가 켜집니다. 디스플레이에 **그룹 호출** 아이콘과 전체 호출이 표시됩니다.

- 3 다음 중 하나를 수행합니다.

- 통화 허용 신호음(활성화된 경우)이 끝날 때까지 기다렸다가 마이크에 대고 명확히 말합니다.

-  **PTT** 사이드톤(활성화된 경우)이 끝날 때까지 기다렸다가 마이크에 대고 또렷하게 말합니다.

채널 상의 사용자는 전체 호출에 응답할 수 없습니다.

프로그래밍 가능 숫자 키를 사용하여 전체 호출 전송

다음 절차에 따라 프로그래밍 가능한 숫자 키를 사용하여 무전기에서 전체 호출을 전송합니다.

- 1 홈 화면에 있는 경우 프로그래밍된 숫자 키를 길게 누르면 미리 정의된 별칭이나 ID로 할당됩니다.

특정 모드에서 항목에 숫자 키를 지정할 경우 다른 모드에서 숫자 키를 길게 누르면 이 기능이 지원되지 않습니다.

항목에 숫자 키가 연결되어 있지 않으면 해제음이 울립니다.

- 2 **PTT** 버튼을 눌러 전화를 전송합니다.

녹색 LED가 켜집니다.

- 3 상대방의 말을 들으려면 **PTT** 버튼을 놓습니다.

대상 무전기가 응답하면 녹색 LED가 켜집니다. 현재 전체 호출에는 응답할 수 없습니다.

- 4  채널 프리 표시 기능이 활성화된 경우 발신 무전기에서 **PTT** 버튼을 놓으면 채널이 사용 가능하여 응답

할 수 있음을 나타내는 짧은 경보음이 울립니다. **PTT** 버튼을 눌러 호출에 응답합니다.

미리 정해진 시간 동안 음성 동작이 없으면 호출이 종료됩니다. 무전기가 호출 시작 전 화면으로 돌아갑니다.

개별 호출의 경우 호출이 끝날 때 짧은 톤이 울립니다.

자세한 내용은 [프로그래밍 가능 숫자 키에 항목 할당 페이지의 383](#) 부분을 참조하십시오.

선택 호출

선택 호출은 개별 무전기 간 호출을 말합니다. 선택 호출은 아날로그 시스템에서의 개별 호출입니다.

선택 호출 송신

선택 호출을 시작하려면 무전기가 프로그래밍되어야 합니다. 다음 절차에 따라 무전기에서 선택 호출을 송신합니다.

- 1 가입자 별칭 또는 ID가 활성화되어 있는 채널을 선택합니다.

- 2 **PTT** 버튼을 눌러 전화를 전송합니다.

녹색 **LED**가 켜집니다. 디스플레이에 **개별 호출** 아이콘, 가입자 별칭 및 호출 상태가 표시됩니다.

- 3 다음 중 하나를 수행합니다.

- 통화 허용 신호음(활성화된 경우)이 끝날 때까지 기다렸다가 마이크에 대고 명확히 말합니다.
-  **PTT** 사이드톤(활성화된 경우)이 끝날 때까지 기다렸다가 마이크에 대고 또렷하게 말합니다.

- 4 상대방의 말을 들으려면 **PTT** 버튼을 놓습니다.

대상 무전기가 응답하면 녹색 **LED**가 켜집니다.

- 5  채널 프리 표시 기능이 활성화된 경우 발신 무전기에서 **PTT** 버튼을 놓으면 채널이 사용 가능하여 응답할 수 있음을 나타내는 짧은 경보음이 울립니다. **PTT** 버튼을 눌러 호출에 응답합니다.

미리 정해진 시간 동안 음성 동작이 없으면 호출이 종료됩니다.

- 6 디스플레이에 통화 종료가 표시됩니다.

선택 호출에 응답 ㉠

다음 절차에 따라 무전기에서 선택 호출에 응답합니다.

선택 호출 수신 시:

- 녹색 LED가 깜박입니다.
- 첫 번째 텍스트 줄에 **개별 호출** 아이콘과 발신자 별칭 또는 선택 호출 또는 경보와 호출이 표시됩니다.
- 무전기 음소거가 해제되고 호출 수신 시 스피커를 통해 소리가 납니다.

1 PTT 버튼을 눌러 호출에 응답합니다.

녹색 LED가 켜집니다.

2 통화 허용 신호음(활성화된 경우)이 끝날 때까지 기다렸다가 마이크에 대고 명확히 말합니다.

3 상대방의 말을 들으려면 **PTT** 버튼을 놓습니다.

미리 정해진 시간 동안 음성 동작이 없으면 호출이 종료됩니다. 신호음이 울립니다. 디스플레이에 통화 종료 표시가 표시됩니다.

전화 통화 ㉡

전화 통화는 개별 무전기에서 전화기로 전송되는 호출을 말합니다.

무전기에서 전화 통화 기능이 활성화되어 있지 않은 경우:

- 디스플레이에 무전기 잠금이 표시됩니다.
- 무전기에서 통화가 음소거됩니다.
- 통화를 종료하면 무전기가 이전 화면으로 돌아갑니다.

전화 통화 중 무전기에서 통화 종료를 시도하는 경우:

- 액세스 해제 코드가 미리 구성된 상태에서 **원터치 액세스** 버튼을 누릅니다.
- 추가 숫자 입력 시 액세스 해제 코드를 입력합니다.

채널에 액세스하거나, 액세스 또는 액세스 해제 코드를 입력하거나, 추가 숫자를 입력하는 중에는 무전기가 **켜기/끄기**, **볼륨 컨트롤**, 및 **채널 선택** 버튼 또는 노브에만 응답합니다. 이 외에 다른 잘못된 버튼을 누르면 톤이 울립니다.

채널 액세스 중 **(5)** 버튼을 눌러 통화 시도를 취소합니다. 신호음이 울립니다.

**주의:**

액세스 코드 또는 액세스 해제 코드는 10자 이내여야 합니다.

자세한 내용은 대리점이나 시스템 관리자에게 문의하십시오.

전화 송신

다음 절차에 따라 무전기에서 전화를 전송합니다.

- 1 프로그래밍된 **원터치 액세스** 버튼을 눌러 미리 정의된 별칭 또는 ID로 이동합니다.
원터치 액세스 버튼 항목이 비어 있으면 해제음이 울립니다. 연락처 목록에서 액세스 코드가 미리 구성되지 않은 경우 디스플레이에 액세스 코드:가 표시됩니다.

- 2 액세스 코드를 입력하고 **OK** 버튼을 눌러 계속합니다.
액세스 코드 또는 액세스 해제 코드는 10자 이내여야 합니다.

- 3 **PTT** 버튼을 눌러 호출에 응답합니다. 상대방의 말을 들으려면 **PTT** 버튼을 놓습니다.

- 4 요청 메시지가 표시된 경우 키패드로 추가 숫자를 입력하고 **OK** 버튼을 눌러 계속합니다.

호출에 필요한 숫자를 추가로 입력하는 동안 호출을 종료하면 무전기가 호출 시작 전 화면으로 돌아갑니다.

이중 신호음 다중 주파수(DTMF) 신호음이 울립니다. 무전기가 이전 화면으로 돌아갑니다.

- 5 **End Call** 버튼을 눌러 통화를 종료합니다.

- 6 다음 중 하나를 수행합니다.

- 액세스 해제 코드가 사전 구성되어 있지 않은 경우 디스플레이에 액세스 해제 코드:가 표시되면 액세스 해제 코드를 입력하고 **OK** 버튼을 눌러 계속합니다.
무전기가 이전 화면으로 돌아갑니다.
- 프로그래밍된 **원터치 액세스** 버튼을 누릅니다.
원터치 액세스 버튼 항목이 비어 있으면 해제음이 울립니다.

DTMF 톤이 울리고 디스플레이에 전화 통화 종료 중이 표시됩니다.

통화를 성공적으로 종료한 경우:







- 신호음이 울립니다.
- 디스플레이에 통화 종료가 표시됩니다.





통화 종료에 실패하면 무전기가 전화 통화 화면으로 돌아갑니다. 마지막 두 단계를 반복하거나 전화기 사용자가 통화를 종료할 때까지 기다립니다.

- 디스플레이의 첫 번째 줄에 전화 번호:가 표시됩니다.
- 디스플레이의 두 번째 줄에 커서가 깜박입니다. 선택한 항목이 비어 있는 경우:
- 해제음이 울립니다.
- 디스플레이에 잘못된 전화 번호가 표시됩니다.

연락처 목록을 사용하여 전화 송신

다음 절차에 따라 연락처 목록을 사용하여 무전기에서 전화를 전송합니다.

- 1  버튼을 눌러 메뉴로 이동합니다.
- 2  또는  버튼을 눌러 연락처로 이동합니다.  버튼을 눌러 선택합니다. 디스플레이에 항목이 알파벳 순으로 표시됩니다.
- 3  또는  버튼을 눌러 원하는 별칭 또는 ID로 이동합니다.  버튼을 눌러 선택합니다. 전화 연락처 화면에서 **PTT** 버튼을 누르는 경우:

- 4  또는  버튼을 눌러 전화 통화로 이동합니다.  버튼을 눌러 선택합니다. 액세스 코드가 사전 구성되어 있지 않은 경우 디스플레이에 액세스 코드:가 표시됩니다.
- 5 액세스 코드를 입력하고  버튼을 눌러 계속합니다. 액세스 코드 또는 액세스 해제 코드는 10자 이내여야 합니다. 첫 번째 텍스트 줄에 발신 중이 표시됩니다. 두 번째 텍스트 줄에는 가입자 별칭 또는 ID와 **통화** 아이콘이 표시됩니다. 통화가 성공한 경우:

- DTMF 톤이 울립니다.
- 전화기 사용자의 발신음이 들립니다.
- 첫 번째 텍스트 줄에 가입자 별칭 또는 ID와 **RSSI** 아이콘이 표시됩니다.
- 두 번째 텍스트 줄에는 전화 및 **통화** 아이콘이 표시됩니다.

통화가 실패한 경우:

- 신호음이 울립니다.
- 디스플레이에 전화 통화 실패가 표시된 다음 액세스 코드:가 표시됩니다.
- 연락처 목록에 액세스 코드가 사전 구성되어 있는 경우 무전기가 통화를 시작하기 전에 있었던 화면으로 돌아갑니다.

6 PTT 버튼을 눌러 호출에 응답합니다.
RSSI 아이콘이 사라집니다.

7 상대방의 말을 들으려면 **PTT** 버튼을 놓습니다.

8 요청 메시지가 표시된 경우 키패드로 추가 숫자를 입력하고  버튼을 눌러 계속합니다.

통화에 필요한 숫자를 추가로 입력하는 동안 통화를 종료하면 무전기가 통화 시작 전 화면으로 돌아갑니다.

DTMF 톤이 울립니다. 무전기가 이전 화면으로 돌아갑니다.

9  버튼을 눌러 통화를 종료합니다.

10 액세스 해제 코드가 사전 구성되어 있지 않은 경우 디스플레이에 액세스 해제 코드:가 표시되면 액세스 해제 코드를 입력하고  버튼을 눌러 계속합니다. 무전기가 이전 화면으로 돌아갑니다. DTMF 톤이 울리고 디스플레이에 전화 통화 종료 중이 표시됩니다. 통화를 성공적으로 종료한 경우:

- 신호음이 울립니다.
- 디스플레이에 통화 종료가 표시됩니다.

통화 종료에 실패하면 무전기가 전화 통화 화면으로 돌아갑니다. **단계 9** 단계 및 **단계 10** 단계를 반복하거나 전화기 사용자가 통화를 종료할 때까지 기다립니다. 전화 연락처 화면에서 **PTT** 버튼을 누르면 톤이 울리고 디스플레이에 통화 시도 시 'OK'를 누르시오가 표시됩니다.

전화기 사용자가 통화를 종료하면 톤이 울리고 디스플레이에 전화 종료가 표시됩니다.

전화에 필요한 숫자를 추가로 입력하는 동안 통화를 종료하면 무전기가 호출 시작 전 화면으로 돌아갑니다.



주의:

채널 액세스 동안  을 눌러 호출 시도를 취소하면 신호음이 울립니다.



액세스 해제 코드가 미리 구성된 상태에서 호출 중에 **원터치 액세스** 버튼을 누르거나, 추가 숫자 입력 시 액세스 해제 코드를 입력하면 무전기에서 호출 종료를 시도합니다.



채널에 액세스하거나, 액세스/액세스 해제 코드를 입력하거나, 추가 숫자를 입력하는 중에는 무전기가 **켜기/끄기** 버튼, **볼륨 노브**, **채널 락커**에만 응답합니다. 이 외에 다른 잘못된 버튼을 누르면 톤이 울립니다.



매뉴얼 다이얼을 사용하여 전화 송신

다음 절차에 따라 매뉴얼 다이얼을 사용하여 무전기에서 전화를 송신합니다.

- 1  버튼을 눌러 메뉴로 이동합니다.

- 2  또는  버튼을 눌러 연락처로 이동합니다.
 버튼을 눌러 선택합니다.

- 3  또는  버튼을 눌러 매뉴얼 다이얼로 이동합니다.  버튼을 눌러 선택합니다.

- 4  또는  버튼을 눌러 전화 번호로 이동합니다.  버튼을 눌러 선택합니다.
디스플레이에 번호:가 표시되며 커서가 깜박입니다.

- 5 전화 번호를 입력하고  버튼을 눌러 계속합니다.
액세스 코드가 사전 구성되어 있지 않은 경우 디스플레이에 액세스 코드:가 표시되며 커서가 깜박입니다.

- 6 액세스 코드를 입력하고  버튼을 눌러 계속합니다.

액세스 코드 또는 액세스 해제 코드는 10자 이내여야 합니다.

7 녹색 LED가 켜집니다. 디스플레이 오른쪽 상단에 **통화** 아이콘이 표시됩니다. 첫 번째 텍스트 줄에 가입자 별칭이 표시됩니다. 두 번째 텍스트 줄에 통화 상태가 표시됩니다.

통화가 성공한 경우:

- DTMF 톤이 울립니다.
- 전화기 사용자의 발신음이 들립니다.
- 첫 번째 텍스트 줄에 가입자 별칭이 표시됩니다.
- 디스플레이 오른쪽 상단에 **통화** 아이콘이 계속 표시됩니다.

통화가 실패한 경우:

- 신호음이 울립니다.
 - 디스플레이에 전화 통화 실패가 표시된 다음 액세스 코드:가 표시됩니다.
 - 연락처 목록에 액세스 코드가 사전 구성되어 있는 경우 무전기가 통화 시작 전 화면으로 돌아갑니다.
-

8  버튼을 눌러 통화를 종료합니다.

9 다음 중 하나를 수행합니다.

- 액세스 해제 코드가 사전 구성되어 있지 않은 경우 디스플레이에 액세스 해제 코드:가 표시되면 액세스 해제 코드를 입력하고  버튼을 눌러 계속합니다. 무전기가 이전 화면으로 돌아갑니다.
- 프로그래밍된 **원터치 액세스** 버튼을 누릅니다. **원터치 액세스** 버튼 항목이 비어 있으면 해제음이 울립니다.

DTMF 톤이 울리고 디스플레이에 전화 통화 종료 중이 표시됩니다.

통화를 성공적으로 종료한 경우:

- 신호음이 울립니다.
- 디스플레이에 통화 종료가 표시됩니다.

통화 종료에 실패하면 무전기가 전화 통화 화면으로 돌아갑니다. **단계 8**을(를) 반복하여 호출을 종료합니다.

**주의:**

전화 연락처 화면에서 **PTT** 버튼을 누르면 톤이 울리고 디스플레이에 통화 시도 시 'OK'를 누르시오가 표시됩니다.

전화기 사용자가 통화를 종료하면 톤이 울리고 디스플레이에 호출 종료가 표시됩니다.

호출에 필요한 숫자를 추가로 입력하는 동안 호출을 종료하면 무전기가 호출 시작 전 화면으로 돌아갑니다.

채널 액세스 동안  을 눌러 호출 시도를 취소하면 신호음이 울립니다.



액세스 해제 코드가 미리 구성된 상태에서 호출 중에 **원터치 액세스** 버튼을 누르거나, 추가 숫자 입력 시 액세스 해제 코드를 입력하면 무전기에서 호출 종료를 시도합니다.



채널에 액세스하거나, 액세스/액세스 해제 코드를 입력하거나, 추가 숫자를 입력하는 중에는 무전기가 **켜기/끄기** 버튼, **블륨 노브**, **채널 락키**에만 응답합니다. 이 외에 다른 잘못된 버튼을 누르면 톤이 울립니다.

별칭 검색을 사용하여 그룹 호출, 개별 호출, 전화 호출 또는 전체 호출 전송





절차에 따라 별칭 검색을 사용하여 호출합니다.

- 1  버튼을 눌러 메뉴로 이동합니다.

- 2  또는  버튼을 눌러 연락처로 이동합니다.
 버튼을 눌러 선택합니다.
디스플레이에 항목이 알파벳 순으로 표시됩니다.

- 3  또는  을 눌러 원하는 가입자 별칭 또는 ID로 이동합니다. 디스플레이의 첫 번째 줄에 전화 번호:가 표시됩니다. 디스플레이의 두 번째 줄에 커서가 깜박입니다. 키패드로 전화 번호를 입력합니다.

- 4  버튼을 눌러 선택합니다. 선택한 항목이 비어 있으면 해제음이 울리고 디스플레이에 잘못된 전화 번호가 표시됩니다.

5  또는  을 눌러 전화 연결 통화 및  버튼을 눌러 선택합니다. 로 이동합니다. 연락처 목록에 액세스 코드가 사전 구성되어 있지 않은 경우 디스플레이의 첫 번째 줄에 액세스 코드:가 표시됩니다. 디스플레이의 두 번째 줄에 커서가 깜박입니다. 액세스 코드를 입력하고  버튼을 눌러 계속합니다. 성공하면 DTMF 톤이 울립니다. 전화기 사용자의 발신음이 들립니다. 디스플레이의 첫 번째 줄에 가입자 별칭 또는 ID, RSSI 아이콘이 표시됩니다. 디스플레이의 두 번째 줄에 전화 및 전화 아이콘이 표시됩니다. 실패하면 톤이 울리고 디스플레이에 전화 접속 통화 실패가 표시됩니다. 무전기가 액세스 코드 입력 화면으로 돌아갑니다. 연락처 목록에 액세스 코드가 사전 구성되어 있는 경우 무전기가 호출을 시작하기 전에 있었던 화면으로 돌아갑니다.

6 말을 하려면 **PTT** 버튼을 누르고, 상대방의 말을 들으려면 **PTT** 버튼을 놓습니다. 전송 중에는 **RSSI** 아이콘이 사라집니다.

7 추가 숫자를 입력하려면, 전화로 요청된 경우 다음 중 하나를 수행합니다.

- 아무 키패드 키를 눌러 추가 숫자 입력을 시작합니다. 디스플레이의 첫 번째 줄에 추가 숫자:가 표시됩니다. 디스플레이의 두 번째 줄에 커서가 깜박입

니다. 추가 숫자를 입력하고  버튼을 눌러 계속합니다. DTMF 톤이 울리고 무전기가 이전 화면으로 돌아갑니다.



- 원터치 액세스** 버튼을 누릅니다. DTMF 톤이 울립니다. **원터치 액세스** 버튼 항목이 비어 있으면 해제음이 울립니다.

8  버튼을 눌러 통화를 종료합니다. 연락처 목록에 액세스 해제 코드가 사전 구성되어 있지 않은 경우 디스플레이의 첫 번째 줄에 액세스 해제 코드:가 표시됩니다. 디스플레이의 두 번째 줄에 커서가 깜박입

니다. 액세스 해제 코드를 입력하고  버튼을 눌러 계속합니다. 무전기가 이전 화면으로 돌아갑니다. DTMF 톤이 울리고 디스플레이에 전화 종료 중이 표시됩니다. 성공하면 톤이 울리고 디스플레이에 전화 종료가 표시됩니다. 무전기가 전화 화면으로 돌아갑니다. 전화 연락처 화면에서 **PTT** 버튼을 누르면 톤이 울리고 디스플레이에 통화 시도 시 'OK'를 누르시오가 표시됩니다. 전화기 사용자가 통화를 종료하면 톤이 울리고 디스플레이에 전화 종료가 표시됩니다. 전화에 필요한 숫자를 추가로 입력하는 동안 통화를 종료하면 무전기가 호출 시작 전 화면으로 돌아갑니다.

**주의:**

채널 액세스 동안  을 눌러 호출 시도를 취소하면 신호음이 울립니다. 또는 별칭 검색을 종료합니

다.  또는  을 눌러 별칭 검색을 종료합니다. 액세스 해제 코드가 미리 구성된 상태에서 호출 중에 **원터치 액세스** 버튼을 누르거나, 추가 숫자 입력 시 액세스 해제 코드를 입력하면 무전기에서 호출 종료를 시도합니다. 채널에 액세스하거나, 액세스/액세스 해제 코드를 입력하거나, 추가 숫자를 입력하는 중에는 무전기가 켜기/끄기 버튼, 볼륨 노브, 채널 락 커에만 응답합니다. 이 외에 다른 잘못된 버튼을 누르면 톤이 울립니다.

이중 신호음 다중 주파수(DTMF)

이중 톤 다중 주파수(DTMF) 기능을 사용하면 무전기 시스템에서 인터페이스를 전화 시스템에 연결해 무전기를 작동할 수 있습니다.



모든 무전기 톤과 경보를 비활성화하여 DTMF 톤을 끌 수 있습니다. 자세한 내용은 **무전기 신호음/경보 켜기 또는 끄기 페이지의 188** 부분을 참조하십시오.

DTMF 호출 시작

다음 절차에 따라 무전기에서 DTMF 호출을 시작합니다.

1 PTT 버튼을 길게 누릅니다.

2 다음 중 하나를 수행합니다.

- 원하는 번호를 입력하여 DTMF 호출을 시작하십시오.
-  을 눌러 DTMF 호출을 시작하십시오.
-  을 눌러 DTMF 호출을 시작하십시오.

그룹 호출로 전화 통화에 응답

다음 절차에 따라 무전기에서 그룹 호출로 전화 통화에 응답합니다.

그룹 호출로 전화 통화를 수신한 경우:

- 디스플레이 오른쪽 상단에 **통화** 아이콘이 표시됩니다.
- 디스플레이에 그룹 별칭 또는 통화가 표시됩니다.

무전기에서 전화 기능이 활성화되어 있지 않은 경우 디스플레이의 첫 번째 줄에 사용 없음이 표시되고 무전기에서

통화가 음소거됩니다. 통화를 종료하면 무전기가 이전 화면으로 돌아갑니다.

1 **PTT** 버튼을 눌러 호출에 응답합니다. 상대방의 말을 들으려면 **PTT** 버튼을 놓습니다.

2  버튼을 눌러 통화를 종료합니다.

디스플레이에 전화 통화 종료 중이 표시됩니다.
통화를 성공적으로 종료한 경우:

- 신호음이 울립니다.
- 디스플레이에 통화 종료가 표시됩니다.

통화 종료에 실패하면 무전기가 전화 통화 화면으로 돌아갑니다. 이 단계를 반복하여 호출을 종료합니다. 또는 전화 사용자가 종료할 때까지 기다립니다.

전체 호출로 전화 통화에 응답

전화 통화를 전체 호출로 받으면 전체 호출 유형이 채널에 지정된 경우에만 호출에 응답하거나 호출을 종료할 수 있습니다. 다음 절차에 따라 무전기에서 전체 호출로 전화 통화에 응답합니다.

전체 호출로 전화 통화를 수신한 경우:

- 디스플레이 오른쪽 상단에 **통화** 아이콘이 표시됩니다.
- 디스플레이에 전체 호출 및 통화가 표시됩니다.

무전기에서 전화 기능이 활성화되어 있지 않은 경우 디스플레이의 첫 번째 줄에 사용 않음이 표시되고 무전기에서 통화가 음소거됩니다.

통화를 종료하면 무전기가 이전 화면으로 돌아갑니다.

1 **PTT** 버튼을 눌러 호출에 응답합니다.

2 상대방의 말을 들으려면 **PTT** 버튼을 놓습니다.

3  버튼을 눌러 통화를 종료합니다.

디스플레이에 전화 통화 종료 중이 표시됩니다.
통화를 성공적으로 종료한 경우:

- 신호음이 울립니다.
- 디스플레이에 전체 호출 및 통화 종료가 표시됩니다.

통화 종료에 실패하면 무전기가 전화 통화 화면으로 돌아갑니다. **단계 3**을(를) 반복하여 호출을 종료합니다.

개별 호출로 전화 통화에 응답 ❷

다음 절차에 따라 무전기에서 개별 호출로 전화 통화에 응답합니다.

개별 호출로 전화 통화를 수신한 경우:

- 디스플레이 오른쪽 상단에 **통화** 아이콘이 표시됩니다.
- 디스플레이에 발신자 별칭 또는 통화가 표시됩니다.

무전기에서 전화 기능이 활성화되어 있지 않은 경우 디스플레이의 첫 번째 줄에 사용 없음이 표시되고 무전기에서 통화가 음소거됩니다. 통화를 종료하면 무전기가 이전 화면으로 돌아갑니다.

1 PTT 버튼을 눌러 호출에 응답합니다. 상대방의 말을 들으려면 **PTT** 버튼을 놓습니다.

2  버튼을 눌러 통화를 종료합니다.

디스플레이에 전화 통화 종료 중이 표시됩니다. 통화를 성공적으로 종료한 경우:

- 신호음이 울립니다.
- 디스플레이에 통화 종료가 표시됩니다.

통화 종료에 실패하면 무전기가 전화 통화 화면으로 돌아갑니다. 이 단계를 반복하여 호출을 종료합니다. 또는 전화 사용자가 종료할 때까지 기다립니다.

무전기 호출 중지 ❷

이 기능을 사용하면 진행 중인 그룹 또는 개별 호출을 중지하여 채널을 전송 가능한 상태로 만들 수 있습니다. 예를 들어 사용자가 **PTT** 버튼을 실수로 눌러 무전기가 "마이크 고정" 상태가 되면 이 기능을 사용할 수 있습니다. 이 기능을 사용할 수 있도록 무전기를 프로그래밍해야 합니다. 다음 절차에 따라 무전기에서 호출을 중지합니다.

1 프로그래밍된 **전송 중단 리모트 디키** 버튼을 누릅니다.

디스플레이에 원격 디키가 표시됩니다.

2 승인을 기다립니다.

성공 시:

- 선택음이 울립니다.
- 디스플레이에 리모트 디키 성공이 표시됩니다.

실패 시:

- 해제음이 울립니다.
- 디스플레이에 리모트 디키 실패가 표시됩니다.



주의:

자세한 내용은 대리점이나 시스템 관리자에게 문의하십시오.

토크어라운드

이 기능을 사용하면 중계기가 작동되고 있지 않은 경우 또는 무전기가 중계기의 범위를 벗어나지만 다른 무전기와 대화 범위 안에 있는 경우 계속해서 통신할 수 있습니다.

전원을 꺼도 토크어라운드 설정이 유지됩니다.



주의:



이 기능은 동일한 주파수에 있는 **Capacity Plus** 단일 사이트, **Capacity Plus** 다중 사이트 및 **Citizens** 대역 채널에는 적용되지 않습니다.



중계기 및 토크어라운드 모드 전환





다음 절차에 따라 무전기에서 중계기 및 토크어라운드 모드를 전환합니다.

- 1 다음 중 하나를 수행합니다.

- 프로그래밍된 **중계기/토크어라운드** 버튼을 누릅니다. 다음 단계를 건너뛴니다.
-  버튼을 눌러 메뉴로 이동합니다.

- 2  또는  버튼을 눌러 유틸리티로 이동합니다.  버튼을 눌러 선택합니다.

- 3  또는  버튼을 눌러 무전기 설정으로 이동합니다.  버튼을 눌러 선택합니다.

- 4  또는  버튼을 눌러 토크어라운드로 이동합니다.  버튼을 눌러 선택합니다.
활성화되면  아이콘이 활성화 옆에 표시됩니다.
비활성화되면  아이콘이 활성화 옆에서 사라집니다.
화면이 자동으로 이전 화면으로 돌아갑니다.

브로드캐스트 음성 호출

브로드캐스트 음성 호출은 모든 사용자에서 전체 통화 그룹으로의 단방향 음성 호출입니다.

브로드캐스트 음성 호출 기능을 사용하면 호출 발신 사용자는 통화 그룹에 전송만 할 수 있으며 호출 수신자가 응답할 수 없습니다(호출 정지 시간 없음).

이 기능을 사용할 수 있도록 무전기를 프로그래밍해야 합니다. 자세한 내용은 대리점이나 시스템 관리자에게 문의하십시오.

브로드캐스트 음성 호출

무전기의 브로드캐스트 음성 호출을 위한 프로그래밍 방법입니다.

1 활성화 그룹 별칭 또는 ID가 있는 채널을 선택합니다.

2 **PTT** 버튼을 눌러 전화를 전송합니다.

녹색 LED가 켜집니다. 디스플레이에는 브로드캐스트 호출, 그룹 호출 아이콘과 별칭이 표시됩니다.

3 다음 중 하나를 수행합니다.

- 통화 허용 신호음(활성화된 경우)이 끝날 때까지 기다렸다가 마이크에 대고 명확히 말합니다.
- **PTT** 사이드톤(활성화된 경우)이 끝날 때까지 기다렸다가 마이크에 대고 또렷하게 말합니다.



주의:

채널 상의 사용자는 브로드캐스트 음성 호출에 응답할 수 없습니다.

호출을 종료하면 무전기가 이전 메뉴로 돌아갑니다.

프로그래밍 가능 숫자 키를 사용한 브로드캐스트 음성 호출

프로그래밍 가능한 숫자 키를 사용하여 무전기에서 브로드캐스트 음성 호출을 하려면 다음 절차를 따르십시오.

1 홈 화면에서 사전 정의된 별칭 또는 ID에 할당된 프로그래밍된 숫자 키를 길게 누릅니다.

특정 모드에서 항목에 숫자 키를 지정할 경우 다른 모드에서 해당 숫자 키를 길게 누르면 이 기능이 지원되지 않습니다.

항목에 숫자 키가 연결되어 있지 않으면 해제음이 울립니다.

2 **PTT** 버튼을 눌러 전화를 전송합니다.



녹색 LED가 켜집니다.

자세한 내용은 [프로그래밍 가능 숫자 키에 항목 할당 페이지의 383](#) 부분을 참조하십시오.

별칭 검색을 사용한 브로드캐스트 음성 호출



다음 절차에 따라 별칭 검색을 사용하여 무전기에서 브로드캐스트 음성 호출을 전송합니다.

1  버튼을 눌러 메뉴로 이동합니다.

2  또는  버튼을 눌러 연락처로 이동합니다.



 버튼을 눌러 선택합니다.

디스플레이에 항목이 알파벳 순으로 표시됩니다.

3  또는  을 눌러 원하는 가입자 별칭 또는 ID로 이동합니다. 디스플레이의 첫 번째 줄에 전화 번

호:가 표시됩니다. 디스플레이의 두 번째 줄에 커서가 깜박입니다. 키패드로 전화 번호를 입력합니다.

4  버튼을 눌러 선택합니다. 선택한 항목이 비어 있으면 해제음이 울리고 디스플레이에 잘못된 전화 번호가 표시됩니다.

5  또는  을 눌러 전화 연결 통화 및  버튼을 눌러 선택합니다.로 이동합니다. 연락처 목록에 액세스 코드가 사전 구성되어 있지 않은 경우 디스플레이의 첫 번째 줄에 액세스 코드:가 표시됩니다. 디스플레이의 두 번째 줄에 커서가 깜박입니다. 액세스 코드를 입력하고  버튼을 눌러 계속합니다. 성공하면 DTMF 톤이 울립니다. 전화기 사용자의 발신음이 들립니다. 디스플레이의 첫 번째 줄에 가입자 별칭 또는 ID, RSSI 아이콘이 표시됩니다. 디스플레이의 두 번째 줄에 전화 및 전화 아이콘이 표시됩니다. 실패하면 톤이 울리고 디스플레이에 전화 접속 통화 실패가 표시됩니다. 무전기가 액세스 코드 입력 화면으로 돌아갑니다. 연락처 목록에 액세스 코드가 사전 구성되어 있는 경우 무전기가 호출을 시작하기 전에 있었던 화면으로 돌아갑니다.

6 말을 하려면 **PTT** 버튼을 누르고, 상대방의 말을 들으려면 **PTT** 버튼을 놓습니다. 전송 중에는 **RSSI** 아이콘이 사라집니다.

7 추가 숫자를 입력하려면, 전화로 요청된 경우 다음 중 하나를 수행합니다.

- 아무 키패드나 키를 눌러 추가 숫자 입력을 시작합니다. 디스플레이의 첫 번째 줄에 추가 숫자:가 표시됩니다. 디스플레이의 두 번째 줄에 커서가 깜박입니다. 추가 숫자를 입력하고 **OK** 버튼을 눌러 계속합니다. **DTMF** 톤이 울리고 무전기가 이전 화면으로 돌아갑니다.
- 원터치 액세스** 버튼을 누릅니다. **DTMF** 톤이 울립니다. **원터치 액세스** 버튼 항목이 비어 있으면 해제음이 울립니다.

8 **☎** 버튼을 눌러 통화를 종료합니다. 연락처 목록에 액세스 해제 코드가 사전 구성되어 있지 않은 경우 디스플레이의 첫 번째 줄에 액세스 해제 코드:가 표시됩니다. 디스플레이의 두 번째 줄에 커서가 깜박입니

다. 액세스 해제 코드를 입력하고 **OK** 버튼을 눌러 계속합니다. 무전기가 이전 화면으로 돌아갑니다. **DTMF** 톤이 울리고 디스플레이에 전화 통화 종료 중이 표시됩니다. 성공하면 톤이 울리고 디스플레이

에 전화 종료가 표시됩니다. 무전기가 전화 화면으로 돌아갑니다. 실패하면 무전기가 전화 화면으로 돌아갑니다. 전화 연락처 화면에서 **PTT** 버튼을 누르면 톤이 울리고 디스플레이에 'OK'를 눌러서 통화하기가 표시됩니다. 전화기 사용자가 통화를 종료하면 톤이 울리고 디스플레이에 전화 종료가 표시됩니다. 전화에 필요한 숫자를 추가로 입력하는 동안 통화가 종료되면 무전기가 호출 시작 전 화면으로 돌아갑니다.



주의:

채널 액세스 동안 **☎** 을 눌러 호출 시도를 취소하면 신호음이 울립니다. 또는 별칭 검색을 종료합니다. **OK** 버튼 또는 **☎** 을 눌러 별칭 검색을 종료합니다. 액세스 해제 코드가 미리 구성된 상태에서 호출 중에 원터치 액세스 버튼을 누르거나, 추가 숫자 입력 시 액세스 해제 코드를 입력하면 무전기에서 호출 종료를 시도합니다. 채널에 액세스하거나, 액세스/액세스 해제 코드를 입력하거나, 추가 숫자를 입력하는 중에는 무전기가 켜기/끄기 버튼, 볼륨 노브, 채널 로커에만 응답합니다. 이 외에 다른 잘못된 버튼을 누르면 톤이 울립니다.

브로드캐스트 음성 호출 수신

브로드캐스트 음성 호출 수신 시:

- 신호음이 울립니다.
- 녹색 LED가 깜박입니다.
- 디스플레이의 오른쪽 상단에 **그룹 호출** 아이콘이 표시됩니다.
- 첫 번째 텍스트 줄에 발신자 별칭 ID가 표시됩니다.
- 두 번째 텍스트 줄에 브로드캐스트 호출이 표시됩니다.
- 무전기 음소거가 해제되고 호출 수신 시 스피커를 통해 소리가 납니다.

통화를 종료하면 무전기가 이전 화면으로 돌아갑니다.

브로드캐스트 음성 호출은 미리 정해진 시간까지 대기하지 않고 종료됩니다.

브로드캐스트 음성 호출에 응답할 수 없습니다.



주의:

무전기에서 호출을 수신하는 동안 다른 채널로 전환하는 경우에는 브로드캐스트 음성 호출 수신에 중지가 됩니다. 브로드캐스트 음성 호출 중에는 호출이 끝날 때까지 메뉴 탐색이나 편집을 계속할 수 없습니다.

주소 미지정 호출

주소 미지정 호출은 16개의 사전 정의된 그룹 ID 중 하나로 그룹 호출을 하는 것입니다.

이 기능은 CPS-RM을 사용해 구성됩니다. 사전 정의된 ID 중 하나에 대한 연락처가 주소 미지정 호출을 시작 및/또는 수신하는 데 필요합니다. 자세한 내용은 대리점이나 시스템 관리자에게 문의하십시오.

주소 미지정 호출

1 **활성 그룹 별칭 또는 ID가 있는 채널을 선택합니다.**

2 **PTT 버튼을 눌러 전화를 전송합니다.**

녹색 LED가 켜집니다. 텍스트 줄에는 주소 미지정 호출, **그룹 호출** 아이콘과 별칭이 표시됩니다.

3 다음 중 하나를 수행합니다.

- 통화 허용 신호음(활성화된 경우)이 끝날 때까지 기다렸다가 마이크에 대고 명확히 말합니다.
- **PTT** 사이드톤(활성화된 경우)이 끝날 때까지 기다렸다가 마이크에 대고 또렷하게 말합니다.

4 상대방의 말을 들으려면 **PTT** 버튼을 놓습니다.

대상 무전기가 응답하면 녹색 LED가 켜집니다. 일시적 음이 울립니다. 디스플레이에는 주소 미지정 호

출, **그룹 호출** 아이콘 및 별칭 또는 ID, 및 발신 무전기 별칭 또는 ID가 표시됩니다.

- 5** 가용 채널 표시 기능이 활성화된 경우 발신 무전기에서 **PTT** 버튼을 놓는 순간 채널이 사용 가능하여 응답할 수 있음을 나타내는 짧은 경보음이 울립니다. **PTT** 버튼을 눌러 호출에 응답합니다.

미리 정해진 시간 동안 음성 동작이 없으면 호출이 종료됩니다.

호출 발신자는  버튼을 눌러 그룹 호출을 종료할 수 있습니다.

- 가용 채널 표시 기능이 활성화된 경우 발신 무전기에서 **PTT** 버튼을 놓으면 채널이 사용 가능하여 응답할 수 있음을 나타내는 짧은 경보음이 울립니다. **PTT** 버튼을 눌러 호출에 응답합니다.
- 음성 중단 기능이 활성화된 경우 **PTT** 버튼을 누르면 발신 무전기에서 오디오가 중단되고 채널이 사용 가능한 상태가 되어 응답할 수 있게 됩니다.

녹색 LED가 켜집니다.

- 2** 다음 중 하나를 수행합니다.

- 통화 허용 신호음(활성화된 경우)이 끝날 때까지 기다렸다가 마이크에 대고 명확히 말합니다.
- **PTT** 사이드톤(활성화된 경우)이 끝날 때까지 기다렸다가 마이크에 대고 또렷하게 말합니다.

- 3** 상대방의 말을 들으려면 **PTT** 버튼을 놓습니다.

미리 정해진 시간 동안 음성 동작이 없으면 호출이 종료됩니다.

주소 미지정 호출에 응답

주소 미지정 호출 수신 시:

- 녹색 LED가 깜박입니다.
- 일시적 음이 울립니다.
- 텍스트 줄에 주소 미지정 호출, 발신자 별칭, 그룹 호출 별칭이 표시됩니다.
- 무전기 음소거가 해제되고 호출 수신 시 스피커를 통해 소리가 납니다.

- 1** 다음 중 하나를 수행합니다.

개방 음성 채널 모드(OVCM)

개방 음성 채널 모드(OVCM)에서 특정 시스템에서 작동하도록 사전 설정되지 않은 무전기는 그룹 또는 개별 호출 중에 수신 및 전송할 수 있습니다.

OVCМ 그룹 호출은 브로드캐스트 호출도 지원합니다. 이 기능을 사용하도록 무전기를 프로그래밍하십시오. 자세한 내용은 대리점이나 시스템 관리자에게 문의하십시오.

OVCМ 호출

OVCМ으로 호출하려면 무전기가 프로그래밍되어야 합니다. 무전기에서 OVCМ으로 호출하려면 다음 절차를 따르십시오.

1 PTT 버튼을 눌러 전화를 전송합니다.

녹색 LED가 켜집니다.

텍스트 줄에는 호출 유형 아이콘, OVCМ 및 별칭이 표시됩니다. 이는 무전기가 OVCМ 상태임을 나타냅니다.

2 다음 중 하나를 수행합니다.

- 통화 허용 신호음(활성화된 경우)이 끝날 때까지 기다렸다가 마이크에 대고 명확히 말합니다.
- PTT 사이드톤(활성화된 경우)이 끝날 때까지 기다렸다가 마이크에 대고 또렷하게 말합니다.

OVCМ 호출에 응답

OVCМ 호출 수신 시:

- 녹색 LED가 깜박입니다.
- 텍스트 줄에 호출 유형 아이콘, OVCМ 및 별칭이 표시됩니다.
- 무전기 음소거가 해제되고 호출 수신 시 스피커를 통해 소리가 납니다.

1 다음 중 하나를 수행합니다.

- 가용 채널 표시 기능이 활성화된 경우 발신 무전기에서 PTT 버튼을 놓으면 채널이 사용 가능하여 응답할 수 있음을 나타내는 짧은 경보음이 울립니다. PTT 버튼을 눌러 호출에 응답합니다.
- 음성 중단 기능이 활성화된 경우 PTT 버튼을 누르면 발신 무전기에서 오디오가 중단되고 채널이 사용 가능한 상태가 되어 응답할 수 있게 됩니다.

녹색 LED가 켜집니다.

2 다음 중 하나를 수행합니다.

- 통화 허용 신호음(활성화된 경우)이 끝날 때까지 기다렸다가 마이크에 대고 명확히 말합니다.

- **PTT** 사이드톤(활성화된 경우)이 끝날 때까지 기다렸다가 마이크에 대고 또렷하게 말합니다.

3 상대방의 말을 들으려면 **PTT** 버튼을 놓습니다.

미리 정해진 시간 동안 음성 동작이 없으면 호출이 종료됩니다.

고급 기능

이 장에서는 무전기에서 사용할 수 있는 기능 작동에 대해 설명합니다.

대리점에서 또는 시스템 관리자가 특정 요구에 맞게 무전기를 사용자 정의했을 수 있습니다. 자세한 내용은 대리점이나 시스템 관리자에게 문의하십시오.

홈 채널 미리 알림

이 기능은 무전기가 일정 시간 동안 홈 채널에 설정되어 있지 않는 경우 미리 알림을 제공합니다.

이 기능이 **CPS**를 통해 활성화된 경우 무전기가 일정 시간 동안 홈 채널에 설정되지 않으면 다음 상황이 주기적으로 발생합니다.

- 홈 채널 미리 알림음과 안내음이 울립니다.
- 디스플레이의 첫 번째 줄에 비가 표시됩니다.

- 첫 번째 줄에 홈 채널이 표시됩니다.

다음 작업 중 하나를 수행하여 미리 알림에 응답할 수 있습니다.

- 홈 채널로 복귀합니다.
- 프로그래밍 가능 버튼을 사용하여 미리 알림을 일시적으로 음소거합니다.
- 프로그래밍 가능 버튼을 사용하여 새로운 홈 채널을 설정합니다.

홈 채널 미리 알림 음소거

홈 채널 미리 알림이 울리면 미리 알림을 일시적으로 음소거할 수 있습니다.

무음 홈 채널 미리 알림 프로그래밍 가능 버튼을 누릅니다.



디스플레이의 첫 번째 줄에 HCR이 표시되고 두 번째 줄에 음소거됨이 표시됩니다.



새 홈 채널 설정



홈 채널 미리 알림이 발생하면 새 홈 채널을 설정할 수 있습니다.





1 다음 중 하나를 수행합니다.

- 현재 채널을 새로운 홈 채널로 설정하려면 **홈 채널 재설정** 프로그래밍 가능 버튼을 누릅니다. 다음 단계를 건너뛴니다.
디스플레이의 첫 번째 줄에 채널 별칭이 표시되고 두 번째 줄에 새 홈 채널이 표시됩니다.
-  버튼을 눌러 메뉴로 이동합니다.

2  또는  버튼을 눌러 유틸리티로 이동합니다.  버튼을 눌러 선택합니다.

3  또는  버튼을 눌러 무전기 설정으로 이동합니다.  버튼을 눌러 선택합니다.

4  또는  버튼을 눌러 홈 채널로 이동합니다.  버튼을 눌러 선택합니다.

5  또는  버튼을 눌러 원하는 새 홈 채널 별칭으로 이동합니다.  버튼을 눌러 선택합니다.
디스플레이에서 선택한 홈 채널 별칭 옆에 가 표시됩니다.



무전기 점검

이 기능을 사용하면 시스템에서 다른 무전기가 활성화되어 무전기 사용자를 방해하고 있지 않은지 여부를 확인할 수 있습니다. 대상 무전기에는 어떠한 청각적/시각적 표시도 나타나지 않습니다. 이 기능은 가입자 별칭 또는 ID에만 적용할 수 있습니다. 이 기능을 사용할 수 있도록 무전기를 프로그래밍해야 합니다.

무전기 점검 전송

다음 절차에 따라 무전기에서 무전기 점검을 전송합니다.

1 프로그래밍된 **무전기 점검** 버튼을 누릅니다.

- 2  또는  버튼을 눌러 원하는 별칭 또는 ID로 이동합니다.  버튼을 눌러 선택합니다.
- 디스플레이에 전환 미니 알림이 표시되어 요청이 진행 중임을 나타냅니다. 녹색 LED가 켜집니다.

승인을 기다립니다.

무전기가 승인을 기다리고 있는 동안  을 누르면 신호음이 울리고 무전기가 모든 재시도를 종료하며 무전기 점검 모드를 종료합니다.

성공 시:

- 선택음이 울립니다.
- 디스플레이에 선택 미니 알림이 표시됩니다.











실패 시:

- 해제음이 울립니다.
- 디스플레이에 해제 미니 알림이 표시됩니다.



무전기가 가입자 별칭 또는 ID 화면으로 돌아갑니다.

매뉴얼 다이얼을 사용하여 무전기 점검 전송

다음 절차에 따라 매뉴얼 다이얼을 사용하여 무전기 점검을 전송합니다.

- 1  버튼을 눌러 메뉴로 이동합니다.
- 2  또는  버튼을 눌러 연락처로 이동합니다.  버튼을 눌러 선택합니다.
- 3  또는  버튼을 눌러 매뉴얼 다이얼로 이동합니다.  버튼을 눌러 선택합니다.
- 4  또는  버튼을 눌러 무전기 번호를 선택합니다.  버튼을 눌러 선택합니다.
- 5 다음 중 하나를 수행합니다.
 - 가입자 별칭 또는 ID를 입력하고  버튼을 눌러 계속합니다.

- 이전에 연결했던 ID를 편집하고  버튼을 눌러 계속합니다.

- 6  또는  버튼을 눌러 무전기 점검으로 이동합니다.  버튼을 눌러 선택합니다.

디스플레이에 전환 미니 알람이 표시되어 요청이 진행 중임을 나타냅니다. 녹색 LED가 켜집니다.

- 7 승인을 기다립니다.

무전기가 승인을 기다리는 동안  버튼을 누르면 신호음이 울리고 무전기가 모든 재시도를 종료하며 무전기 점검 모드를 종료합니다.

성공 시:

- 선택음이 울립니다.
- 디스플레이에 선택 미니 알람이 표시됩니다.

실패 시:

- 해제음이 울립니다.
- 디스플레이에 해제 미니 알람이 표시됩니다.

무전기가 가입자 별칭 또는 ID 화면으로 돌아갑니다.

원격 모니터링

이 기능을 사용하면 가입자 별칭 또는 ID로 대상 무전기의 마이크를 켤 수 있습니다. 이 기능을 사용하면 대상 무전기와 관련된 모든 오디오 동작을 원격으로 모니터링할 수 있습니다.

원격 모니터에는 두 가지 유형이 있습니다.

- 인증 없는 원격 모니터
- 인증 있는 원격 모니터

인증된 원격 모니터는 유료로 이용할 수 있는 기능입니다. 인증된 원격 모니터에서 대상 무전기의 마이크를 켜려면 확인이 필요합니다.

무전기가 사용자 인증이 설정된 대상 무전기에 이 기능을 실행할 때 암호구가 필요합니다. 암호구는 CPS를 통해 대상 무전기로 미리 프로그래밍할 수 있습니다.



이 기능을 사용할 수 있도록 무전기와 대상 무전기 모두를 프로그래밍해야 합니다.

프로그래밍된 지속 시간 후 또는 대상 무전기에서 사용자 작업이 있는 경우 이 기능이 자동으로 중지됩니다.

원격 모니터 시작

다음 절차에 따라 무전기에서 원격 모니터를 시작합니다.

1 프로그래밍된 **원격 모니터** 버튼을 누릅니다.

2  또는  버튼을 눌러 원하는 별칭 또는 ID로 이동합니다.

3  버튼을 눌러 선택합니다. 다음 시나리오 중 하나가 발생합니다.

- 디스플레이에 전환 미니 알람이 표시되어 요청이 진행 중임을 나타냅니다. 녹색 LED가 켜집니다.
- 암호구 화면이 표시됩니다.

암호구를 입력합니다.  버튼을 눌러 계속합니다.

- 암호구가 올바르면 디스플레이에 전환 미니 알람이 표시되어 요청이 진행 중임을 나타냅니다. 녹색 LED가 켜집니다.
 - 암호구가 틀리면 디스플레이에 해제 미니 알람이 표시되고 이전 화면으로 돌아갑니다.
-

4 승인을 기다립니다.

성공 시:

- 선택음이 울립니다.

- 디스플레이에 선택 미니 알람이 표시됩니다.
- 무전기에서 프로그래밍된 시간 동안 모니터링된 무전기로부터 음성을 수신하기 시작하고 디스플레이에 원격 모니터가 표시됩니다. 타이머가 만료 되면 경보음이 울리고 LED가 꺼집니다.



실패 시:

- 해제음이 울립니다.
 - 디스플레이에 해제 미니 알람이 표시됩니다.
-



연락처 목록을 사용하여 원격 모니터 시작



다음 절차에 따라 연락처 목록을 사용하여 무전기에서 원격 모니터를 시작합니다.

1  버튼을 눌러 메뉴로 이동합니다.

2  또는  버튼을 눌러 연락처로 이동합니다.

 버튼을 눌러 선택합니다.

3  또는  버튼을 눌러 원하는 별칭 또는 ID로 이동합니다.  버튼을 눌러 선택합니다.

4  또는  버튼을 눌러 원격 모니터로 이동합니다.

5  버튼을 눌러 선택합니다. 다음 시나리오 중 하나가 발생합니다.

- 디스플레이에 전환 미니 알림이 표시되어 요청이 진행 중임을 나타냅니다. 녹색 LED가 켜집니다.
- 암호구 화면이 표시됩니다.

암호구를 입력합니다.  버튼을 눌러 계속합니다.

- 암호구가 올바르면 디스플레이에 전환 미니 알림이 표시되어 요청이 진행 중임을 나타냅니다. 녹색 LED가 켜집니다.
 - 암호구가 틀리면 디스플레이에 해제 미니 알림이 표시되고 이전 화면으로 돌아갑니다.
-

6 승인을 기다립니다.
성공 시:

- 선택음이 울립니다.
- 디스플레이에 선택 미니 알림이 표시됩니다.
- 무전기에서 프로그래밍된 시간 동안 모니터링된 무전기로부터 음성을 수신하기 시작하고 디스플레이에 원격 모니터가 표시됩니다. 타이머가 만료되면 정보음이 울리고 LED가 꺼집니다.



실패 시:

- 해제음이 울립니다.
 - 디스플레이에 해제 미니 알림이 표시됩니다.
-

매뉴얼 다이얼을 사용하여 원격 모니터 시작

다음 절차에 따라 매뉴얼 다이얼을 사용하여 무전기에서 원격 모니터를 시작합니다.

1  버튼을 눌러 메뉴로 이동합니다.

2  또는  버튼을 눌러 연락처로 이동합니다.

 버튼을 눌러 선택합니다.

3 ▲ 또는 ▼ 버튼을 눌러 매뉴얼 다이얼로 이동합니다. [OK] 버튼을 눌러 선택합니다.

4 ▲ 또는 ▼ 버튼을 눌러 무전기 번호를 선택합니다. [OK] 버튼을 눌러 선택합니다.

5 다음 중 하나를 수행합니다.

- 가입자 별칭 또는 ID를 입력하고 [OK] 버튼을 눌러 계속합니다.
 - 이전에 연결했던 ID를 편집하고 [OK] 버튼을 눌러 계속합니다.
-

6 ▲ 또는 ▼ 버튼을 눌러 원격 모니터로 이동합니다.

7 [OK] 버튼을 눌러 선택합니다. 다음 시나리오 중 하나가 발생합니다.

- 디스플레이에 전환 미니 알람이 표시되어 요청이 진행 중임을 나타냅니다. 녹색 LED가 켜집니다.
- 암호구 화면이 표시됩니다.

암호구를 입력합니다. [OK] 버튼을 눌러 계속합니다.

- 암호구가 올바르면 디스플레이에 전환 미니 알람이 표시되어 요청이 진행 중임을 나타냅니다. 녹색 LED가 켜집니다.
 - 암호구가 틀리면 디스플레이에 해제 미니 알람이 표시되고 이전 화면으로 돌아갑니다.
-

8 승인을 기다립니다.

성공 시:

- 선택음이 울립니다.
- 디스플레이에 선택 미니 알람이 표시됩니다.
- 무전기에서 프로그래밍된 시간 동안 모니터링된 무전기로부터 음성을 수신하기 시작하고 디스플레이에 원격 모니터가 표시됩니다. 타이머가 만료되면 경보음이 울리고 LED가 꺼집니다.

실패 시:

- 해제음이 울립니다.
 - 디스플레이에 해제 미니 알람이 표시됩니다.
-

스캔 목록

스캔 목록은 생성된 후 개별 채널 또는 그룹에 지정됩니다. 무전기는 현재 채널 또는 그룹에 대해 스캔 목록에 지정된 채널 또는 그룹 순서대로 돌아가며 음성 동작을 스캔합니다.

무전기는 최대 **250개** 스캔 목록을 지원하며 목록 하나에 최대 **16개** 구성원이 포함될 수 있습니다.

각 스캔 목록에는 아날로그 및 디지털 항목이 혼합될 수 있습니다.

스캔 목록을 편집하여 채널을 추가 또는 삭제하거나 우선 순위를 지정할 수 있습니다.

전면 패널 프로그래밍 모드를 통해 무전기에 새 스캔 목록을 연결할 수 있습니다. 자세한 내용은 [전면 패널 구성 페이지의 177](#) 부분을 참조하십시오.

멤버 별칭 왼쪽에 **우선 순위** 아이콘이 표시되어(설정된 경우) 멤버가 우선 **1** 채널 목록에 있는지, 아니면 우선 **2** 채널 목록에 있는지 나타냅니다. 스캔 목록에 여러 개의 우선 **1** 또는 우선 **2** 채널이 있을 수 없습니다. 우선 순위가 **없음**으로 설정된 경우 **우선 순위** 아이콘이 나타나지 않습니다.







주의:



이 기능은 **Capacity Plus**에는 적용되지 않습니다.



스캔 목록의 항목 보기

다음 절차에 따라 무전기에서 스캔 목록의 항목을 봅니다.

- 1  버튼을 눌러 메뉴로 이동합니다.

- 2  또는  버튼을 눌러 스캔으로 이동합니다.
 버튼을 눌러 선택합니다.



- 3  또는  버튼을 눌러 스캔 목록으로 이동합니다.  버튼을 눌러 선택합니다.



- 4  또는  버튼을 눌러 목록에서 각 멤버를 봅니다.

별칭 검색을 사용하여 스캔 목록의 항목 보기

다음 절차에 따라 별칭 검색을 사용하여 무전기에서 스캔 목록의 항목을 봅니다.

1  버튼을 눌러 메뉴로 이동합니다.

2  또는  버튼을 눌러 스캔으로 이동합니다.
 버튼을 눌러 선택합니다.

3  또는  버튼을 눌러 스캔 목록으로 이동합니다.  버튼을 눌러 선택합니다.



4 원하는 별칭의 첫 문자를 입력합니다.
 디스플레이에 커서가 깜박입니다.



5 원하는 별칭의 나머지 문자를 입력합니다.
 별칭 검색은 대소문자를 구분하지 않습니다. 같은 이름의 항목이 두 개 이상 있으면 디스플레이에는 목록에 첫 번째로 나열된 항목이 표시됩니다.
 첫 번째 텍스트 줄에 입력한 문자가 표시됩니다. 다음 텍스트 줄에는 간략히 나열된 검색 결과가 표시됩니다.



스캔 목록에 새 항목 추가



다음 절차에 따라 무전기의 스캔 목록에 새 항목을 추가합니다.



1  버튼을 눌러 메뉴로 이동합니다.

2  또는  버튼을 눌러 스캔으로 이동합니다.
 버튼을 눌러 선택합니다.







3  또는  버튼을 눌러 스캔 목록으로 이동합니다.  버튼을 눌러 선택합니다.

4  또는  버튼을 눌러 멤버 추가로 이동합니다.  버튼을 눌러 선택합니다.

5  또는  버튼을 눌러 원하는 별칭 또는 ID로 이동합니다.  버튼을 눌러 선택합니다.

- 6  또는  버튼을 눌러 원하는 우선 순위 레벨로 이동합니다.  버튼을 눌러 선택합니다. 디스플레이에 선택 미니 알림이 표시된 다음 기타 추가?가 표시됩니다.

7 다음 중 하나를 수행합니다.

-  또는  버튼을 누르고 예를 선택하여 다른 항목을 추가합니다.  버튼을 눌러 선택합니다. 단계 5 및 단계 6 단계를 반복합니다.
-  또는  버튼을 누르고 아니오를 선택하여 현재 목록을 저장합니다.  버튼을 눌러 선택합니다.

별칭 검색을 사용하여 스캔 목록에 새 항목 추가



다음 절차에 따라 별칭 검색을 사용하여 무전기의 스캔 목록에 새 항목을 추가합니다.

- 1  버튼을 눌러 메뉴로 이동합니다.
- 2  또는  버튼을 눌러 스캔으로 이동합니다.  버튼을 눌러 선택합니다.
- 3  또는  버튼을 눌러 스캔 목록으로 이동합니다.  버튼을 눌러 선택합니다.
- 4  또는  버튼을 눌러 멤버 추가로 이동합니다.  버튼을 눌러 선택합니다.
- 5 원하는 별칭의 첫 문자를 입력합니다. 디스플레이에 커서가 깜박입니다.
- 6 원하는 별칭의 나머지 문자를 입력합니다.



별칭 검색은 대소문자를 구분하지 않습니다. 같은 이름의 항목이 두 개 이상 있으면 디스플레이에는 목록에 첫 번째로 나열된 항목이 표시됩니다.



첫 번째 텍스트 줄에 입력한 문자가 표시됩니다. 다음 텍스트 줄에는 간략히 나열된 검색 결과가 표시됩니다.

7  버튼을 눌러 선택합니다.

8  또는  버튼을 눌러 원하는 우선 순위 레벨로 이동합니다.  버튼을 눌러 선택합니다. 디스플레이에 선택 미나 알림이 표시된 다음 기타 추가?가 표시됩니다.

9 다음 중 하나를 수행합니다.



-  또는  버튼을 누르고 예를 선택하여 다른 항목을 추가합니다.  버튼을 눌러 선택합니다. 단계 5 ~ 단계 8 단계를 반복합니다.



-  또는  버튼을 누르고 아니오를 선택하여 현재 목록을 저장합니다.  버튼을 눌러 선택합니다.



스캔 목록에서 항목 삭제



다음 절차에 따라 스캔 목록에서 항목을 삭제합니다.







1  버튼을 눌러 메뉴로 이동합니다.

2  또는  버튼을 눌러 스캔으로 이동합니다.  버튼을 눌러 선택합니다.

3  또는  버튼을 눌러 스캔 목록으로 이동합니다.  버튼을 눌러 선택합니다.

4  또는  버튼을 눌러 원하는 별칭 또는 ID로 이동합니다.  버튼을 눌러 선택합니다.

- 5  또는  버튼을 눌러 삭제로 이동합니다.
 버튼을 눌러 선택합니다.
 디스플레이에 항목 삭제?가 표시됩니다.













- 6 다음 중 하나를 수행합니다.
-  또는  버튼을 누르고 예를 선택하여 항목을 삭제합니다.  버튼을 눌러 선택합니다.
 디스플레이에 선택 미니 알림이 표시됩니다.
 -  또는  버튼을 누르고 아니오를 선택하여 이전 화면으로 돌아갑니다.  버튼을 눌러 선택합니다.



- 7 다른 항목을 삭제하려면 **단계 4 ~ 단계 6** 단계를 반복합니다.

- 8 원하는 별칭 또는 ID를 전체 삭제한 후에는  버튼을 길게 눌러 홈 화면으로 돌아갑니다.

스캔 목록에서 항목 우선 순위 설정

다음 절차에 따라 무전기의 스캔 목록에서 항목의 우선 순위를 설정합니다.

- 1  버튼을 눌러 메뉴로 이동합니다.
-
- 2  또는  버튼을 눌러 스캔으로 이동합니다.
 버튼을 눌러 선택합니다.
-
- 3  또는  버튼을 눌러 스캔 목록으로 이동합니다.  버튼을 눌러 선택합니다.
-
- 4  또는  버튼을 눌러 원하는 별칭 또는 ID로 이동합니다.  버튼을 눌러 선택합니다.
-
- 5  또는  버튼을 눌러 우선 순위 편집으로 이동합니다.  버튼을 눌러 선택합니다.

6  또는  버튼을 눌러 원하는 우선 순위 레벨로 이동합니다.  버튼을 눌러 선택합니다.

이전 화면으로 돌아가기 전에 디스플레이에 선택 미니 알림이 표시됩니다. 멤버 별칭 왼쪽에 **우선 순위** 아이콘이 나타납니다.

스캔

스캔을 시작하면 무전기가 현재 채널에 대해 프로그래밍된 스캔 목록의 각 항목을 돌아가며 음성 동작을 조회합니다.



주의:

이 기능은 **Capacity Plus**에는 적용되지 않습니다.

듀얼 모드 스캔 중에 사용자가 디지털 채널에 있고 무전기가 아날로그 채널에 고정되어 있는 경우에는 무전기가 호출 시간 동안 디지털 모드에서 아날로그 모드로 자동 전환됩니다. 그 반대의 경우에도 마찬가지입니다.

스캔은 다음과 같은 두 가지 방법으로 시작할 수 있습니다.

주 채널 스캔(수동)

무전기가 스캔 목록의 모든 채널 또는 그룹을 스캔합니다. 스캔으로 전환할 때 설정에 따라 마지막으로 스캔한 활성 채널이나 그룹, 또는 스캔이 시작되었던 채널에서 무전기가 스캔을 자동으로 시작할 수 있습니다.

자동 스캔(자동)

자동 스캔이 활성화된 채널 또는 그룹을 선택하면 무전기가 스캔을 자동으로 시작합니다.



주의:

스캔으로 그룹 메시지 수신으로 구성하면 무전기가 홈 외 채널에서 그룹 메시지를 수신할 수 있습니다. 무전기는 홈 채널에서 그룹 메시지에 회신할 수 있지만 홈 외 채널에서는 회신할 수 없습니다. 자세한 내용은 대리점이나 시스템 관리자에게 문의하십시오.



스캔 켜기 또는 끄기

다음 절차에 따라 무전기에서 스캔을 켜거나 끕니다.

1



 버튼을 눌러 메뉴로 이동합니다.

2



 또는  버튼을 눌러 스캔으로 이동합니다.

 버튼을 눌러 선택합니다.

3

 또는  을 눌러 스캔 상태로 이동합니다.

 버튼을 눌러 선택합니다.

- 4  또는  을 눌러 원하는 스캔 상태로 이동하고  를 눌러 선택합니다.

스캔이 활성화된 경우:

- 디스플레이에 스캔 켜기 및 스캔 아이콘이 표시됩니다.
- 노란색 LED가 깜박입니다.

스캔이 비활성화된 경우:

- 디스플레이에 스캔 끄기가 표시됩니다.
- 스캔 아이콘이 사라집니다.
- LED가 꺼집니다.

스캔 중 전송 응답

스캔 도중에는 동작이 감지되는 채널 또는 그룹에서 무전기가 중지됩니다. 무전기는 보류 시간이라고 하는 프로그래밍된 시간 동안 해당 채널에 머무릅니다. 다음 절차에 따라 스캔 중 전송에 응답합니다.

- 1  채널 프리 표시 기능이 활성화된 경우 발신 무전기에서 **PTT** 버튼을 놓으면 채널이 사용 가능하여 응답

할 수 있음을 나타내는 짧은 경보음이 울립니다. 보류 시간 중에 **PTT** 버튼을 누릅니다.

녹색 LED가 켜집니다.

- 2 상대방의 말을 들으려면 **PTT** 버튼을 놓습니다.

보류 시간 내에 응답하지 않으면 무전기가 다른 채널 또는 그룹 스캔 작업으로 돌아갑니다.

방해 채널 삭제

어떤 채널이 계속해서 원하지 않는 호출이나 소음을 발생시킬 경우("방해" 채널) 스캔 목록에서 원하지 않는 채널을 일시적으로 제거할 수 있습니다. 이 기능은 선택한 채널로 지정된 채널에는 적용되지 않습니다. 다음 절차에 따라 무전기에서 방해 채널을 삭제합니다.

- 1 무전기가 원하지 않는 채널이나 방해 채널에 고정되는 경우 경보음이 울릴 때까지 프로그래밍된 **방해 채널 삭제** 버튼을 누릅니다.
- 2 프로그래밍된 **방해 채널 삭제** 버튼에서 손을 땁니다. 방해 채널이 삭제됩니다.

방해 채널 복원

다음 절차에 따라 무전기에서 방해 채널을 복원합니다.

다음 중 하나를 수행합니다.

- 무전기를 끈 다음 다시 전원을 켭니다.
- 프로그래밍된 **스캔** 버튼이나 메뉴를 통해 스캔을 중지했다가 다시 시작합니다.
- **채널 업/다운** 버튼을 사용하여 채널을 변경합니다.

보트 스캔

투표 스캔은 다른 아날로그 채널에서 동일한 정보를 송신하는 기지국이 여러 개 있는 지역에서 광역 서비스를 제공합니다.

무전기가 여러 기지국의 아날로그 채널을 스캔하고 투표 프로세스를 수행하여 강도가 가장 높은 수신 신호를 선택합니다. 설정이 완료되면 무전기가 해당 기지국의 전송을 수신합니다.

투표 스캔 중에는 노란색 LED가 깜박이고 디스플레이에 **투표 스캔** 아이콘이 표시됩니다.

투표 스캔 중에 송신에 응답하려면 **스캔 중 전송 응답 페이지의 380** 부분과 동일한 절차를 수행합니다.

연락처 설정

연락처는 무전기에서 주소록 기능을 제공합니다. 각 항목은 호출을 시작하는 데 사용되는 별칭 또는 ID에 해당합니다. 항목은 알파벳 순서대로 정렬되어 있습니다.

각 항목은 컨텍스트에 따라 그룹 호출, 개별 호출, 전체 호출, PC 호출 또는 디스패치 호출이라는 서로 다른 통화 유형과 연결됩니다.

PC 호출 및 디스패치 호출은 데이터와 관련되어 있습니다. 이러한 호출은 응용 프로그램에서만 사용할 수 있습니다. 자세한 내용은 데이터 응용 프로그램 설명서를 참조하십시오.

 또한 연락처 모음 메뉴를 사용하여 각 항목을 키패드 마이크의 프로그래밍 가능 숫자 키에 지정합니다. 숫자 키에 항목이 지정되면 무전기가 해당 항목에 대한 신속 다이얼을 수행할 수 있습니다.



주의:

항목에 지정된 각 숫자 키 앞에는 확인 표시가 있습니다. 비어 있음 앞에 확인 표시가 있으면 항목에 숫자 키를 지정하지 않은 것입니다.

연락처에 있는 각 항목에는 다음 정보가 표시됩니다.







- 호출 유형
- 호출 별칭
- 호출 ID

**주의:**

채널에서 프라이버시 기능이 활성화된 경우 해당 채널에서 프라이버시 활성 그룹 호출, 개별 호출 및 전체 호출을 전송할 수 있습니다. 무전기와 동일한 프라이버시 키 또는 키 값과 키 ID를 가진 대상 무전기만 발신의 암호를 풀 수 있습니다.

연락처 목록을 사용하여 그룹 호출 전송

다음 절차에 따라 연락처 목록을 사용하여 무전기에서 그룹 호출을 전송합니다.

- 1  버튼을 눌러 메뉴로 이동합니다.
- 2  또는  버튼을 눌러 연락처로 이동합니다.
 버튼을 눌러 선택합니다.
- 3  또는  버튼을 눌러 원하는 별칭 또는 ID로 이동합니다.  버튼을 눌러 선택합니다.
- 4 **PTT** 버튼을 눌러 전화를 전송합니다.
녹색 LED가 켜집니다.

- 5 상대방의 말을 들으려면 **PTT** 버튼을 놓습니다.





그룹 내 모든 사용자가 응답하면 녹색 LED가 깜박입니다. 디스플레이에 **그룹 호출** 아이콘, 별칭 또는 ID, 발신 무전기 별칭 또는 ID가 표시됩니다.



- 6  채널 프리 표시 기능이 활성화된 경우 발신 무전기에서 **PTT** 버튼을 놓으면 채널이 사용 가능하여 응답할 수 있음을 나타내는 짧은 경보음이 울립니다. **PTT** 버튼을 눌러 호출에 응답합니다.

미리 정해진 시간 동안 음성 동작이 없으면 호출이 종료됩니다.

연락처 목록을 사용하여 개별 호출 전송

다음 절차에 따라 연락처 목록을 사용하여 무전기에서 개별 호출을 전송합니다.

- 1  버튼을 눌러 메뉴로 이동합니다.
- 2  또는  버튼을 눌러 연락처로 이동합니다.
 버튼을 눌러 선택합니다.

3  또는  버튼을 눌러 원하는 별칭 또는 ID로 이동합니다.  버튼을 눌러 선택합니다.

4 **PTT** 버튼을 눌러 전화를 전송합니다.
녹색 LED가 켜집니다. 디스플레이에 대상 별칭이 표시됩니다.

5 통화 허용 신호음(활성화된 경우)이 끝날 때까지 기다렸다가 마이크에 대고 명확히 말합니다.

6 상대방의 말을 들으려면 **PTT** 버튼을 놓습니다.
대상 무전기가 응답하면 녹색 LED가 깜박입니다. 디스플레이에 전송 중인 사용자 별칭 또는 ID가 표시됩니다.



7  채널 프리 표시 기능이 활성화된 경우 발신 무전기에서 **PTT** 버튼을 놓으면 채널이 사용 가능하여 응답할 수 있음을 나타내는 짧은 경보음이 울립니다. **PTT** 버튼을 눌러 호출에 응답합니다.



미리 정해진 시간 동안 음성 동작이 없으면 호출이 종료됩니다. 신호음이 울립니다. 디스플레이에 통화 종료 표시가 표시됩니다.



프로그래밍 가능 숫자 키에 항목 할당

다음 절차에 따라 무전기에서 프로그래밍 가능한 숫자 키에 항목을 지정합니다.

1  버튼을 눌러 메뉴로 이동합니다.



2  또는  버튼을 눌러 연락처로 이동합니다.
 버튼을 눌러 선택합니다.

3  또는  버튼을 눌러 원하는 별칭 또는 ID로 이동합니다.  버튼을 눌러 선택합니다.



4  또는  버튼을 눌러 프로그램 키를 선택합니다.  버튼을 눌러 선택합니다.

5 다음 중 하나를 수행합니다.

- 원하는 숫자 키가 항목에 지정되지 않는 경우



 또는  버튼을 눌러 원하는 숫자 키로 이동합니다.  버튼을 눌러 선택합니다.

- 원하는 숫자 키가 항목에 지정되어 있는 경우 디스플레이에 이 키는 할당됨이 표시된 다음 첫 번째 텍스트 줄에 덮어쓸까요?가 표시됩니다. 다음 중 하나를 수행합니다.

 또는  버튼을 눌러 예를 선택합니다.

 버튼을 눌러 선택합니다.

무전기에서 선택음이 울리고 디스플레이에 연락처 저장 완료와 선택 미니 알림이 표시됩니다.

 또는  을 눌러 아니요를 선택하여 이전 단계로 돌아갑니다.

각 항목을 서로 다른 숫자 키에 연결할 수 있습니다. 항목에 할당된 각 숫자 키 앞에는 ✓ 표시가 있습니다. 비었음 앞에 ✓ 표시가 있으면 해당 숫자 키가 할당되지 않은 것입니다. 특정 모드에서 항목에 숫자 키를 지정할 경우 다른 모드에서 숫자 키를 길게 누르면 이 기능이 지원되지 않습니다.

화면이 자동으로 이전 메뉴로 돌아갑니다.



항목과 프로그래밍 가능 숫자 키의 관계 제거

다음 절차에 따라 무전기에서 항목과 프로그래밍 가능한 숫자 키의 관계를 제거합니다.



1 다음 중 하나를 수행합니다.

- 프로그래밍된 숫자 키를 길게 눌러 원하는 별칭이나 ID로 이동합니다. [단계 4](#)로 진행합니다.
-  버튼을 눌러 메뉴로 이동합니다.



2



 또는  버튼을 눌러 연락처로 이동합니다.
 버튼을 눌러 선택합니다.



3

 또는  버튼을 눌러 원하는 별칭 또는 ID로 이동합니다.  버튼을 눌러 선택합니다.

4

 또는  버튼을 눌러 프로그램 키를 선택합니다.  버튼을 눌러 선택합니다.

- 5  또는  버튼을 눌러 비어 있음을 선택합니다.  버튼을 눌러 선택합니다.
첫 번째 텍스트 줄에 모든 키에서 삭제가 표시됩니다.
-

- 6  또는  버튼을 눌러 예를 선택합니다.  버튼을 눌러 선택합니다.



주의:

항목이 삭제되면 항목과 프로그래밍된 해당 숫자 키의 관계가 제거됩니다.



선택음이 울립니다. 디스플레이에 연락처 저장됨이 표시됩니다.



화면이 자동으로 이전 메뉴로 돌아갑니다.



새 연락처 추가

다음 절차에 따라 무전기에 새 연락처를 추가합니다.

- 1  버튼을 눌러 메뉴로 이동합니다.
-

- 2  또는  버튼을 눌러 연락처로 이동합니다.  버튼을 눌러 선택합니다.
-

- 3  또는  버튼을 눌러 새 연락처로 이동합니다.  버튼을 눌러 선택합니다.
-

- 4  또는  을 눌러 연락처 유형 무전기 연락처 또는 전화 연락처를 선택합니다.  버튼을 눌러 선택합니다.
-

- 5 키패드로 연락처 번호를 입력하고  버튼을 눌러 계속합니다.
-



- 6 키패드로 연락처 이름을 입력하고  버튼을 눌러 계속합니다.
-

- 7 ▲ 또는 ▼ 버튼을 눌러 원하는 호출음 유형으로 이동합니다.  버튼을 눌러 선택합니다. 선택음이 울립니다. 디스플레이에 선택 미니 알림이 표시됩니다.

- 4 ▲ 또는 ▼ 버튼을 눌러 초기화로 이동합니다.  버튼을 눌러 선택합니다. 선택음이 울립니다. 디스플레이에 선택 미니 알림이 표시됩니다. 디스플레이에서 선택한 기본 별칭 또는 ID 옆에 ✓이 표시됩니다.

기본 연락처 설정

다음 절차에 따라 무전기에서 기본 연락처를 설정합니다.



- 1  버튼을 눌러 메뉴로 이동합니다.
- 2 ▲ 또는 ▼ 버튼을 눌러 연락처로 이동합니다.  버튼을 눌러 선택합니다.
- 3 ▲ 또는 ▼ 버튼을 눌러 원하는 별칭 또는 ID로 이동합니다.  버튼을 눌러 선택합니다.

호출 표시 설정

이 기능을 사용하면 무전기 사용자가 호출 또는 문자 메시지 호출음을 구성할 수 있습니다.

호출 경보용 호출음 활성화 또는 비활성화

다음 절차에 따라 무전기에서 호출 경보용 호출음을 켜거나 끕니다.



- 1  버튼을 눌러 메뉴로 이동합니다.
- 2 ▲ 또는 ▼ 버튼을 눌러 유틸리티로 이동합니다.  버튼을 눌러 선택합니다.

3 ▲ 또는 ▼ 버튼을 눌러 무전기 설정으로 이동합니다.  버튼을 눌러 선택합니다.

4 ▲ 또는 ▼ 버튼을 눌러 신호음/경보로 이동합니다.  버튼을 눌러 선택합니다.

5 ▲ 또는 ▼ 버튼을 눌러 호출음으로 이동합니다.  버튼을 눌러 선택합니다.

6 ▲ 또는 ▼ 버튼을 눌러 호출 경보로 이동합니다.  버튼을 눌러 선택합니다.

7 ▲ 또는 ▼ 버튼을 눌러 원하는 신호음으로 이동합니다.  버튼을 눌러 선택합니다.  디스플레이에 선택한 신호음 옆에  가 표시됩니다.

개별 호출용 호출음 활성화 또는 비활성화





다음 절차에 따라 무전기에서 개별 호출용 호출음을 활성화하거나 비활성화합니다.



1  버튼을 눌러 메뉴로 이동합니다.

2 ▲ 또는 ▼ 버튼을 눌러 유틸리티로 이동합니다.  버튼을 눌러 선택합니다.

3 ▲ 또는 ▼ 버튼을 눌러 무전기 설정으로 이동합니다.  버튼을 눌러 선택합니다.

4 ▲ 또는 ▼ 버튼을 눌러 톤/경보로 이동합니다.  버튼을 눌러 선택합니다.



5 ▲ 또는 ▼ 버튼을 눌러 호출음으로 이동합니다.  버튼을 눌러 선택합니다.

6  또는  을 눌러 개별 호출로 이동합니다.



 버튼을 눌러 선택합니다.

개별 호출 경보음이 활성화된 경우 디스플레이의 커기 옆에 가 표시됩니다.

개별 호출 경보음이 비활성화된 경우 디스플레이의 끄기 옆에 가 표시됩니다.

7  또는  버튼을 눌러 원하는 신호음으로 이동합니다.

 버튼을 눌러 선택합니다.



활성화되면 아이콘이 활성화 옆에 표시됩니다.비활성화되면 아이콘이 활성화 옆에서 사라집니다.

선택 호출용 호출음 활성화 또는 비활성화





다음 절차에 따라 무전기에서 선택 호출용 호출음을 활성화하거나 비활성화합니다.



1  버튼을 눌러 메뉴로 이동합니다.

2  또는  버튼을 눌러 유틸리티로 이동합니다.



 버튼을 눌러 선택합니다.

3  또는  버튼을 눌러 무전기 설정으로 이동합니다.



 버튼을 눌러 선택합니다.

4  또는  버튼을 눌러 톤/경보로 이동합니다.

 버튼을 눌러 선택합니다.

5  또는  버튼을 눌러 호출음으로 이동합니다.

 버튼을 눌러 선택합니다.

6  또는  버튼을 눌러 선택 호출로 이동합니다.





 버튼을 눌러 선택합니다.

디스플레이에  및 현재 신호음이 표시됩니다.

- 7 ▲ 또는 ▼ 버튼을 눌러 원하는 신호음으로 이동합니다.  버튼을 눌러 선택합니다. ✓ 디스플레이에 선택한 신호음 옆에 가 표시됩니다.

문자 메시지용 호출음 활성화 또는 비활성화

다음 절차에 따라 무전기에서 문자 메시지용 호출음을 활성화하거나 비활성화합니다.

- 1  버튼을 눌러 메뉴로 이동합니다.
- 2 ▲ 또는 ▼ 버튼을 눌러 유틸리티로 이동합니다.  버튼을 눌러 선택합니다.
- 3 ▲ 또는 ▼ 버튼을 눌러 무전기 설정으로 이동합니다.  버튼을 눌러 선택합니다.
- 4 ▲ 또는 ▼ 버튼을 눌러 톤/경보로 이동합니다.  버튼을 눌러 선택합니다.

- 5 ▲ 또는 ▼ 버튼을 눌러 호출음으로 이동합니다.  버튼을 눌러 선택합니다.



- 6 ▲ 또는 ▼ 을 눌러 문자 메시지로 이동합니다.  버튼을 눌러 선택합니다. 디스플레이에 ✓ 및 현재 신호음이 표시됩니다.



- 7 ▲ 또는 ▼ 버튼을 눌러 원하는 신호음으로 이동합니다.  버튼을 눌러 선택합니다. 디스플레이에서 새로 선택한 신호음 옆에 ✓가 표시됩니다.



문자 텔레메트리 상태용 호출음 활성화 또는 비활성화



다음 절차에 따라 무전기에서 문자 텔레메트리 상태용 호출음을 활성화하거나 비활성화합니다.





- 1  버튼을 눌러 메뉴로 이동합니다.

- 2  또는  버튼을 눌러 유틸리티로 이동합니다.  버튼을 눌러 선택합니다.

- 3  또는  버튼을 눌러 무전기 설정으로 이동합니다.  버튼을 눌러 선택합니다.

- 4  또는  버튼을 눌러 신호음/경보로 이동합니다.  버튼을 눌러 선택합니다.



- 5  또는  버튼을 눌러 호출음으로 이동합니다.  버튼을 눌러 선택합니다.



- 6  또는  을 눌러 텔리메트리로 이동합니다.  버튼을 눌러 선택합니다.
현재 신호음은  로 표시됩니다.



벨 스타일 지정

특정 연락처의 개별 호출, 호출 경보 및 문자 메시지를 수신할 때 미리 정의된 11가지 경보음 중 하나가 울리도록 무전기를 프로그래밍할 수 있습니다. 목록을 탐색하면 무전기에서 각각의 벨 스타일이 울립니다. 다음 절차에 따라 무전기에서 벨 스타일을 지정합니다.

- 1  버튼을 눌러 메뉴로 이동합니다.



- 2  또는  버튼을 눌러 연락처로 이동합니다.  버튼을 눌러 선택합니다.
항목은 알파벳 순서대로 정렬되어 있습니다.

- 3  또는  버튼을 눌러 원하는 별칭 또는 ID로 이동합니다.  버튼을 눌러 선택합니다.

- 4  또는  을 눌러 보기/편집으로 이동합니다.  버튼을 눌러 선택합니다.

5 디스플레이에 벨소리 메뉴가 나타날 때까지  를 누릅니다.

✓는 현재 선택된 신호음을 나타냅니다.

6  또는  을 눌러 원하는 신호음으로 이동합니다.  버튼을 눌러 선택합니다.

선택한 신호음 옆에 ✓A가 표시됩니다.



무전기의 시스템 구성에 따라 부재중 호출 경보를 호출 로그에 포함시킬 수 있습니다. 각 호출 목록에서 다음 작업을 수행할 수 있습니다.



- 별칭 또는 ID를 연락처에 저장
- 호출 삭제
- 전체 호출 삭제
- 세부 항목 보기

최근 호출 목록 보기

다음 절차에 따라 무전기에서 최근 호출 목록을 봅니다.

1  버튼을 눌러 메뉴로 이동합니다.

2  또는  버튼을 눌러 호출 목록으로 이동합니다.  버튼을 눌러 선택합니다.

3  또는  버튼을 눌러 원하는 목록으로 이동합니다. 부재 중, 응답 및 발신 목록 중 하나를 선택할 수 있습니다.

알람음 볼륨 높이기



무전기 호출이 무응답 상태로 있는 경우 계속 경보로 알리도록 무전기를 프로그래밍할 수 있습니다. 알람음이 울릴수록 볼륨이 자동으로 증가되도록 하면 됩니다. 이 기능을 끄지는 경보음이라고 합니다.

호출 목록 기능

무전기는 최근의 모든 발신, 응답 및 부재 중 개별 호출에 대한 기록을 보관합니다. 호출 목록 기능을 사용하면 최근 호출을 보고 관리할 수 있습니다.

 버튼을 눌러 선택합니다.

디스플레이에 가장 최근의 항목이 표시됩니다.



4  또는  버튼을 눌러 목록을 봅니다.



PTT 버튼을 눌러 디스플레이에 현재 표시된 별칭 또는 ID로 호출을 시작할 수 있습니다.

호출 목록에서 호출 삭제 ●

다음 절차에 따라 호출 목록에서 호출을 삭제합니다.

1  버튼을 눌러 메뉴로 이동합니다.



2  또는  버튼을 눌러 호출 목록으로 이동합니다.  버튼을 눌러 선택합니다.



3  또는  버튼을 눌러 원하는 목록으로 이동합니다.  버튼을 눌러 선택합니다.

목록이 비어 있는 경우:





- 신호음이 울립니다.

- 디스플레이에 목록 비어 있음이 표시됩니다.

4  또는  버튼을 눌러 원하는 별칭 또는 ID로 이동합니다.  버튼을 눌러 선택합니다.

5  또는  을 눌러 항목 삭제?로 이동합니다.  버튼을 눌러 선택합니다.



6 다음 중 하나를 수행합니다.



-  버튼을 눌러 예를 선택하고 항목을 삭제합니다. 디스플레이에 항목 삭제 완료가 표시됩니다.
-  또는  버튼을 눌러 아니오로 이동합니다.  버튼을 눌러 선택합니다. 무전기가 이전 화면으로 돌아갑니다.



호출 목록 세부 항목 보기 ●



다음 절차에 따라 무전기에서 호출 세부 정보를 확인합니다.

- 1  버튼을 눌러 메뉴로 이동합니다.

- 2  또는  버튼을 눌러 호출 목록으로 이동합니다.  버튼을 눌러 선택합니다.

- 3  또는  버튼을 눌러 원하는 목록으로 이동합니다.  버튼을 눌러 선택합니다.

- 4  또는  버튼을 눌러 원하는 별칭 또는 ID로 이동합니다.  버튼을 눌러 선택합니다.

- 5  또는  버튼을 눌러 세부 항목 보기로 이동합니다.  버튼을 눌러 선택합니다.
디스플레이에 호출 세부 정보가 표시됩니다.

호출 목록의 별칭 또는 ID 저장

다음 절차에 따라 호출 목록에서 무전기의 별칭 또는 ID를 저장합니다.

- 1  버튼을 눌러 메뉴로 이동합니다.

- 2  또는  버튼을 눌러 호출 목록으로 이동합니다.  버튼을 눌러 선택합니다.

- 3  또는  버튼을 눌러 원하는 목록으로 이동합니다.  버튼을 눌러 선택합니다.

- 4  또는  버튼을 눌러 원하는 별칭 또는 ID로 이동합니다.  버튼을 눌러 선택합니다.

- 5  또는  버튼을 눌러 저장으로 이동합니다.
 버튼을 눌러 선택합니다.
디스플레이에 커서가 깜박입니다.

- 6 원하는 별칭의 나머지 문자를 입력합니다.  버튼을 눌러 선택합니다.

별칭 없이 ID만 저장할 수 있습니다.
디스플레이에 선택 미니 알림이 표시됩니다.

호출 정보 승인이 수신되지 않으면 디스플레이에 해제 미니 알림이 표시됩니다.

호출 정보 작동

호출 정보 페이지 기능을 사용하면 호출한 사용자에게 연락하도록 특정 무전기 사용자에게 경보를 보낼 수 있습니다.

이 기능은 가입자 별칭 또는 ID에만 적용할 수 있으며 연락처, 매뉴얼 다이얼 또는 프로그래밍된 **원터치 액세스** 버튼을 이용하여 메뉴를 통해 액세스할 수 있습니다.

호출 정보 전송











다음 절차에 따라 무전기에서 호출 정보를 전송합니다.

- 1 프로그래밍된 **원터치 액세스** 버튼을 누릅니다.
디스플레이에 호출 정보와 가입자 별칭 또는 ID가 표시됩니다. 녹색 LED가 켜집니다.

- 2 승인을 기다립니다.
호출 정보 승인이 수신되면 디스플레이에 선택 미니 알림이 표시됩니다.

연락처 목록을 사용하여 호출 정보 전송

다음 절차에 따라 연락처 목록을 사용하여 무전기에서 호출 정보를 전송합니다.

- 1  버튼을 눌러 메뉴로 이동합니다.
- 2  또는  버튼을 눌러 연락처로 이동합니다.
 버튼을 눌러 선택합니다.
- 3  또는  버튼을 눌러 원하는 별칭 또는 ID로 이동합니다.  버튼을 눌러 선택합니다.
- 4  또는  버튼을 눌러 호출 정보로 이동합니다.  버튼을 눌러 선택합니다.
디스플레이에 호출 정보와 가입자 별칭 또는 ID가 표시됩니다. 녹색 LED가 켜집니다.



5 승인을 기다립니다.



- 호출 정보 승인이 수신되면 디스플레이에 선택 미니 알림이 표시됩니다.
- 호출 정보 승인이 수신되지 않으면 디스플레이에 해제 미니 알림이 표시됩니다.

매뉴얼 다이얼을 사용하여 호출 정보 전송



다음 절차에 따라 매뉴얼 다이얼을 사용하여 무전기에서 호출 정보를 송신합니다.

1  버튼을 눌러 메뉴로 이동합니다.

2  또는  버튼을 눌러 연락처로 이동합니다.
 버튼을 눌러 선택합니다.

3  또는  버튼을 눌러 매뉴얼 다이얼로 이동합니다.  버튼을 눌러 선택합니다.
디스플레이에 커서가 깜박입니다.

4 가입자 ID를 입력하고  버튼을 눌러 계속합니다.

5  또는  버튼을 눌러 호출 정보로 이동합니다.  버튼을 눌러 선택합니다.

디스플레이에 호출 정보와 가입자 별칭 또는 ID가 표시됩니다. 녹색 LED가 켜집니다.

6 승인을 기다립니다.

- 호출 정보 승인이 수신되면 디스플레이에 선택 미니 알림이 표시됩니다.
- 호출 정보 승인이 수신되지 않으면 디스플레이에 해제 미니 알림이 표시됩니다.

호출 정보에 응답

다음 절차에 따라 무전기에서 호출 정보에 응답합니다.

호출 정보를 수신하는 경우:

- 반복음이 울립니다.
- 노란색 LED가 깜박입니다.

- 디스플레이에 발신 무전기의 별칭 또는 ID와 함께 호출 정보가 나열된 알림 목록이 표시됩니다.

대리점이나 시스템 관리자의 구성에 따라 다음 중 하나를 수행하여 호출 정보에 응답할 수 있습니다.

- PTT** 버튼을 누르고 발신자에게 직접 개별 호출로 응답합니다.
- PTT** 버튼을 눌러 정상적인 통화 그룹 통신을 계속합니다.
호출 정보가 호출 목록 메뉴에서 부재중 호출 옵션으로 이동합니다. 부재 중 호출 목록에서 발신자에게 응답할 수 있습니다.

자세한 내용은 [알림 목록 페이지의 175](#) 및 [호출 목록 기능 페이지의 116](#) 부분을 참조하십시오.

음소거 모드

음소거 모드는 사용자가 무전기의 모든 오디오 표시등의 음을 소거할 수 있는 옵션을 제공합니다.

음소거 모드 기능이 실행되면 비상 작동과 같은 우선순위가 높은 기능을 제외한 모든 오디오 표시등이 음소거됩니다.

음소거 모드가 종료되면 무전기가 진행 중인 신호음과 오디오 전송을 재개합니다.



주의:

이 기능은 유료입니다. 자세한 내용은 대리점이나 시스템 관리자에게 문의하십시오.

음소거 모드 켜기

다음 절차에 따라 음소거 모드를 켭니다.

프로그래밍된 **음소거 모드** 버튼을 사용하여 이 기능에 액세스합니다.

음소거 모드가 활성화되면 다음이 발생합니다.



- 선택음이 울립니다.
- 디스플레이에 음소거 모드 켜기가 표시됩니다.
- 빨간색 LED가 깜박이기 시작하며 음소거 모드가 종료될 때까지 깜박입니다.
- 디스플레이의 홈 화면에 **음소거 모드** 아이콘이 표시됩니다.
- 무전기가 음소거됩니다.
- 구성된 기간 동안 음소거 모드 타이머가 카운트를 세기 시작합니다.



음소거 모드 타이머 설정



음소거 모드 기능은 음소거 모드 타이머의 시간을 미리 구성하여 활성화할 수 있습니다. 이 타이머는 무전기 메뉴에서 구성 가능하며 0.5-6시간 범주 내에서 설정할 수 있습니다. 타이머가 만료되면 음소거 모드도 종료됩니다.



타이머의 남은 시간이 0이면 미리 프로그래밍된 **음소거 모드** 버튼을 누를 때까지 음소거 상태를 무한 시간 동안 유지합니다.

- 1  버튼을 눌러 메뉴로 이동합니다.

- 2  또는  버튼을 눌러 유틸리티로 이동합니다.  버튼을 눌러 선택합니다.

- 3  또는  버튼을 눌러 무전기 설정으로 이동합니다.  버튼을 눌러 선택합니다.

- 4  또는  버튼을 눌러 음소거 타이머로 이동합니다.  버튼을 눌러 선택합니다.

- 5  또는  버튼을 눌러 다음 숫자 값을 수정한 뒤  버튼을 누릅니다.
-

음소거 모드 종료

이 기능은 음소거 모드 타이머가 만료되면 자동으로 종료할 수 있습니다.

다음 방법 중 한 가지를 사용하여 음소거 모드를 수동으로 종료합니다.

- 프로그래밍된 **음소거 모드** 버튼을 누릅니다.
 - 아무 항목에서 **PTT** 버튼을 누릅니다.
-

음소거 모드가 비활성화되면 다음이 발생합니다.

- 해제음이 울립니다.
- 디스플레이에 음소거 모드 끄기가 표시됩니다.
- 점멸하는 빨간색 LED가 꺼집니다.
- **음소거 모드** 아이콘이 홈 화면에서 사라집니다.
- 무전기의 음소거가 해제되고 스피커 상태가 복구됩니다.
- 타이머가 만료되지 않으면 음소거 모드 타이머가 중단됩니다.



주의:

또한 사용자가 음성을 전송하거나 프로그래밍되지 않은 채널로 전환하면 음소거 모드가 종료됩니다.

- 비상 경보
- 비상 알람 및 호출
- 비상 알람 후 음성 알람 

비상 작동

비상 알람은 중요 상황을 나타내는 데 사용됩니다. 현재 채널에서 동작이 없을 때라도 언제든지 비상 작업을 시작할 수 있습니다.

대리점에서 프로그래밍된 **비상 버튼**의 버튼 누름 지속 시간을 설정할 수 있습니다. 단, 다른 모든 버튼과 마찬가지로 길게 누르기는 제외입니다.

짧게 누르기

지속 시간 0.05초 ~ 0.75초.

길게 누르기

지속 시간 1.00초 ~ 3.75초.

비상 버튼은 비상 켜기/끄기 기능으로 지정됩니다. **비상 버튼**에 작동 지정은 대리점에 문의하십시오.



주의:

비상 버튼을 짧게 누르면 비상 모드가 시작되는 경우 길게 누르면 비상 모드가 종료됩니다.

비상 버튼을 길게 누르면 비상 모드가 시작되는 경우 짧게 누르면 비상 모드가 종료됩니다.

무전기는 다음과 같은 세 가지 비상 알람을 지원합니다.



주의:

위의 비상 알람 중 하나만 프로그래밍된 **비상 버튼**이나 비상 쏫 스위치에 지정할 수 있습니다.

또한 알람마다 다음과 같은 유형이 있습니다.

일반

무전기가 경보 신호를 발신하며 상태 표시음 및/또는 표시등으로 이를 나타냅니다.

무음

무전기가 경보 신호를 발신하지만 상태 표시음 및/또는 표시등은 작동하지 않습니다. 프로그래밍된 **핫 마이크** 전송 기간이 종료되거나 **PTT** 버튼을 누를 때까지 무전기가 해당 스피커를 통해 소리 없이 호출을 수신합니다.

무음 및 음성

무전기가 상태 표시음이나 표시등 작동 없이 경보 신호를 발신하지만 호출 수신 시 스피커를 통해 소리가 나도록 합니다.





비상 알람 수신

다음 절차에 따라 무전기에서 비상 알람을 수신합니다.

비상 알람 수신 시:

- 신호음이 울립니다.
- 빨간색 LED가 깜박입니다.
- 디스플레이에 **비상** 아이콘 및 비상 발신자 별칭이 표시되거나 두 개 이상의 알람이 있는 경우 모든 비상 발신자 별칭이 알람 목록에 표시됩니다.

1 다음 중 하나를 수행합니다.

- 알람이 하나만 수신되면  버튼을 눌러 세부 항목을 더 봅니다.
- 알람이 여러 개 수신되면  또는  버튼을 눌러 원하는 별칭으로 이동하고  버튼을 눌러 세부 항목을 더 봅니다.

2  버튼을 눌러 동작 옵션을 봅니다.

3  버튼을 누르고 예를 선택하여 알람 목록을 종료합니다.

4  버튼을 눌러 메뉴로 이동합니다.

5 알람 목록을 다시 보려면 알람 목록을 선택합니다.



6 사용자가 비상 모드를 종료할 때까지 신호음이 울리고 LED가 적색으로 깜박입니다. 그러나 신호음이 울리지 않게 할 수 있습니다. 다음 중 하나를 수행합니다.

- **PTT** 버튼을 눌러 비상 알람을 수신한 무전기 그룹을 호출합니다.
- 프로그래밍 가능 버튼을 누릅니다.
- 비상 모드를 종료합니다. **비상 알람 수신 후 비상 모드 종료 페이지의 400**을 참조하십시오.

비상 알람에 응답

다음 절차에 따라 무전기에서 비상 알람에 응답합니다.

1 디스플레이에 알람 목록이 표시되는지 확인합니다.

 또는  버튼을 눌러 원하는 별칭 또는 ID로 이동합니다.

2  채널 프리 표시 기능이 활성화된 경우 발신 무전기에서 **PTT** 버튼을 놓으면 채널이 사용 가능하여 응답할 수 있음을 나타내는 짧은 경보음이 울립니다. **PTT**

버튼을 누르면 비상 알람 대상으로 지정된 동일한 그룹에 비상 시가 아닌 음성을 전송합니다.

녹색 LED가 켜집니다. 무전기가 비상 모드로 유지됩니다.

3 다음 중 하나를 수행합니다.

- 통화 허용 신호음(활성화된 경우)이 끝날 때까지 기다렸다가 마이크에 대고 명확히 말합니다.
-  PTT 사이드톤(활성화된 경우)이 끝날 때까지 기다렸다가 마이크에 대고 또렷하게 말합니다.

4 상대방의 말을 들으려면 PTT 버튼을 놓습니다.

비상을 시작한 무전기가 응답하는 경우:

- 녹색 LED가 깜박입니다.
- 디스플레이에 **그룹 호출** 아이콘, ID, 발신 무전기 ID 및 알람 목록이 표시됩니다.

비상 음성은 비상을 시작한 무전기에서만 전송할 수 있습니다. 비상을 수신한 무전기를 포함한 다른 모든 무전기가 비상 시가 아닌 음성을 전송합니다.

비상 알람 수신 후 비상 모드 종료

비상 알람을 수신한 후에는 다음 중 하나를 수행하여 비상 모드를 종료합니다.

- 알람 항목을 삭제합니다.
- 무전기의 전원을 끕니다.

비상 알람 전송

이 기능을 사용하면 무전기 그룹에 경보 표시를 발생시키는 비상 알람(비음성 신호)을 전송할 수 있습니다. 무전기가 묵음으로 설정되면 비상 모드 중에 신호음이나 상태 표시 화면이 나타나지 않습니다.

다음 절차에 따라 무전기에서 비상 알람을 전송합니다.

1 프로그래밍된 비상 켜기 버튼을 누릅니다.

다음 결과 중 하나가 나타납니다.

- 디스플레이에 송신 알람과 대상 별칭이 표시됩니다.
-  디스플레이에 송신 텔레그램과 대상 별칭이 표시됩니다.

녹색 LED가 켜집니다. **비상** 아이콘이 표시됩니다.

**주의:**

프로그래밍된 경우, 비상 검색 신호음이 울립니다. 이 신호음은 무전기에서 음성을 전송하거나 수신할 때에는 음소거되고, 무전기의 비상 모드가 종료되면 중지됩니다. 비상 검색 신호음은 CPS를 통해 프로그래밍할 수 있습니다.

2 승인을 기다립니다.

성공 시:

- 비상 신호음이 울립니다.
- 빨간색 LED가 깜박입니다.
- 디스플레이에 알람 전송이 표시됩니다.

모든 재시도 횟수를 초과하여 실패한 경우:

- 신호음이 울립니다.
- 디스플레이에 알람 실패가 표시됩니다.

비상 알람 모드가 종료되고 무전기가 홈 화면으로 돌아옵니다.

비상 알람 및 호출 전송

이 기능을 사용하면 호출로 비상 알람을 무전기 그룹으로 전송할 수 있습니다. 그룹 내 무전기 중 하나가 승인하면 무전기 그룹 전체가 프로그래밍된 비상 채널상에서 통신할 수 있습니다.

다음 절차에 따라 무전기에서 호출을 통해 비상 알람을 전송합니다.

- 1 프로그래밍된 **비상 켜기** 버튼이나 **비상** 풋 스위치를 누릅니다. 디스플레이에 알람 전송(무전기 ID와 번갈아 나타남)이 표시됩니다.

다음을 참조하십시오.

- 디스플레이에 송신 텔레그램과 대상 별칭이 표시됩니다.

녹색 LED가 켜집니다. **비상** 아이콘이 표시됩니다.

**주의:**

프로그래밍된 경우, 비상 검색 신호음이 울립니다. 이 신호음은 무전기에서 음성을 전송하거나 수신할 때에는 음소거되고, 무전기의 비상 모드가 종료되면 중지됩니다. 비상 검색 신호음은 대리점이나 시스템 관리자에 의해 프로그래밍될 수 있습니다.

2 승인을 기다립니다.

성공 시:

- 비상 신호음이 울립니다.
- 빨간색 LED가 깜박입니다.
- 디스플레이에 알람 전송이 표시됩니다.
- 디스플레이에 비상과 대상 그룹 별칭이 표시되면 무전기가 비상 호출 모드로 전환됩니다.

3 PTT 버튼을 눌러 전화를 전송합니다.

녹색 LED가 켜집니다. 디스플레이에 **그룹 호출** 아이콘이 표시됩니다.

4 다음 중 하나를 수행합니다.

- 통화 허용 신호음(활성화된 경우)이 끝날 때까지 기다렸다가 마이크에 대고 명확히 말합니다.
-  PTT 사이드톤(활성화된 경우)이 끝날 때까지 기다렸다가 마이크에 대고 또렷하게 말합니다.

5 상대방의 말을 들으려면 PTT 버튼을 놓습니다.

디스플레이에 발신자 및 그룹 별칭이 표시됩니다.

6  채널 프리 표시 기능이 활성화된 경우 발신 무전기에서 **PTT** 버튼을 놓으면 채널이 사용 가능하여 응답할 수 있음을 나타내는 짧은 경보음이 울립니다. **PTT** 버튼을 눌러 호출에 응답합니다.

7 호출이 끝나고 비상 모드를 종료하려면 **비상 끄기** 버튼을 누릅니다.

무전기가 홈 화면으로 돌아갑니다.

비상 알람 후 음성 알람

이 기능을 사용하면 지시 음성이 포함된 비상 알람을 무전기 그룹으로 전송할 수 있습니다. 무전기 마이크가 자동으로 활성화되어 **PTT** 버튼을 누르지 않고도 무전기 그룹과 통신할 수 있습니다. 이와 같이 활성화된 마이크 상태를 **핫 마이크**라고도 합니다.



주의:

이 무전기는 후면 액세스리 커넥터에 연결된 비 **IMPRES** 마이크를 감지할 수 없습니다. 프로그래밍된 특정 커넥터에서 마이크가 감지되지 않으면 대체 커넥터를 확인합니다. 이 때 무전기는 감지된 마이크에 우선 순위를 부여합니다.

무전기의 비상 주기 모드가 활성화된 경우 **핫 마이크**와 수신 기간이 프로그래밍된 기간 동안 반복됩니다. 비상 주기 모드 동안 수신된 호출이 스피커를 통해 울립니다.

프로그래밍된 수신 주기 중에 **PTT** 버튼을 누르면 **PTT** 버튼에서 손을 떼라는 금지 신호음이 들립니다. 무전기에서 **PTT** 버튼 작동을 무시하고 비상 모드를 누른 채로 유지합니다.

핫 마이크 중에 **PTT** 버튼을 누르고 **핫 마이크** 기간이 만료된 후에도 계속 누르고 있으면 **PTT** 버튼을 놓을 때까지 무전기가 전송을 계속합니다.

비상 알람 요청에 실패하면 무전기가 요청 전송을 다시 시도하지 않고 **핫 마이크** 상태로 바로 전환됩니다.



주의:

액세서리에 따라 **핫 마이크**가 지원되지 않을 수도 있습니다. 자세한 내용은 대리점이나 시스템 관리자에게 문의하십시오.

비상 알람 후 음성 알림 전송

다음 절차에 따라 무전기에서 지시 음성이 포함된 비상 알람을 전송합니다.

- 1 프로그래밍된 **비상 켜기** 버튼이나 **비상** 풋 스위치를 누릅니다.

다음 결과 중 하나가 나타납니다.

- 디스플레이에 송신 알람과 대상 별칭이 표시됩니다.
- 디스플레이에 송신 텔레그램과 대상 별칭이 표시됩니다.

녹색 **LED**가 켜집니다. **비상** 아이콘이 표시됩니다.

-
- 2 디스플레이에 알람 전송이 표시되면 마이크에 대고 명확히 말합니다.

다음과 같은 경우 무전기에서 자동으로 전송을 중지합니다.

- 비상 주기 모드가 활성화된 경우 **핫 마이크**와 호출 수신 간 주기 기간이 만료될 때
- 비상 주기 모드가 비활성화된 경우 **핫 마이크** 기간이 만료될 때

-
- 3 **비상 끄기** 버튼을 눌러 비상 모드를 종료합니다. 무전기가 홈 화면으로 돌아갑니다.
-

비상 모드 재시작

이 기능은 비상 알람을 전송 중인 무전기에만 적용됩니다.
다음 절차에 따라 무전기에서 비상 모드를 재시작합니다.

다음 중 하나를 수행합니다.

- 무전기가 비상 모드에 있는 동안 채널을 변경합니다. 새 채널에서 비상 알람이 활성화되면 무전기가 비상 모드를 종료하고 재시작합니다.
- 비상 시작 또는 전송 상태 중에 프로그래밍된 **비상 켜기** 버튼을 누릅니다. 무전기가 이 상태를 종료하고 비상 모드를 재시작합니다.

비상 알람 전송 후 비상 모드 종료

이 기능은 비상 알람을 전송 중인 무전기에만 적용됩니다.
다음의 경우 무전기에서 긴급 모드가 종료됩니다.

- 송신이 수신된 경우(비상 알람만 해당)
- 모든 경보 전송 재시도 횟수를 초과한 경우



주의:

무전기 전원이 꺼지면 비상 모드가 종료됩니다. 무전기를 다시 켜도 비상 모드가 자동으로 다시 시작되지 않습니다.







다음 절차에 따라 무전기에서 비상 모드를 종료합니다.



다음 중 하나를 수행합니다.

- 프로그래밍된 **비상 끄기** 버튼을 누릅니다.
- 비상 시스템이 구성되지 않는 새 채널로 채널을 변경합니다.
디스플레이에 비상 아님이 표시됩니다.

알람 목록에서 알람 항목 삭제

다음 절차를 따라 비상 모드를 종료하기 위해 알람 목록에서 알람 항목을 삭제합니다.

- 1  버튼을 눌러 메뉴로 이동합니다.
- 2  또는  을 눌러 알람 목록으로 이동합니다.
 버튼을 눌러 선택합니다.
- 3  또는  을 눌러 원하는 알람 항목으로 이동합니다.  버튼을 눌러 선택합니다.

- 4  또는  버튼을 눌러 삭제로 이동합니다.
 버튼을 눌러 선택합니다.

문자 메시지

이 무전기는 다른 무전기나 문자 메시지 응용 프로그램에서 문자 메시지와 같은 데이터를 수신할 수 있습니다.

DMR(Digital Mobile Radio) 단문 메시지 및 문자 메시지라는 두 가지 유형의 문자 메시지가 있습니다. DMR 단문 메시지의 최대 길이는 23자입니다. 문자 메시지의 최대 길이는 제목 줄을 포함하여 280자입니다. 제목 줄은 이메일 응용 프로그램에서 보낸 메시지를 받은 경우에만 나타납니다.



주의:











최대 문자 길이는 최신 소프트웨어 및 하드웨어 모델에만 해당합니다. 이전 소프트웨어 및 하드웨어가 있는 무전기 모델의 경우 문자 메시지의 최대 길이는 140자입니다. 자세한 내용은 대리점이나 시스템 관리자에게 문의하십시오.

문자 메시지

문자 메시지는 수신 문자함에 저장되며 최근에 수신된 순서대로 정렬됩니다.

문자 메시지 보기



다음 절차에 따라 무전기에서 문자 메시지를 봅니다.



- 1  버튼을 눌러 메뉴로 이동합니다.
- 2  또는  버튼을 눌러 메시지로 이동합니다.
 버튼을 눌러 선택합니다.
- 3  또는  버튼을 눌러 수신 문자함으로 이동합니다.  버튼을 눌러 선택합니다.
수신 문자함이 비어 있는 경우:
 - 디스플레이에 목록 비어 있음이 표시됩니다.
 - 키패드 신호음이 켜져 있는 경우 신호음이 울립니다.
- 4  또는  버튼을 눌러 원하는 메시지로 이동합니다.  버튼을 눌러 선택합니다.
이메일 응용 프로그램에서 메시지를 보낸 경우에는 제목 줄이 표시됩니다.



텔레메트리 상태 문제 메시지 보기

다음 절차에 따라 수신 문자함에서 텔레메트리 상태 문자 메시지를 봅니다.

1  버튼을 눌러 메뉴로 이동합니다.

2  또는  버튼을 눌러 메시지로 이동합니다.
 버튼을 눌러 선택합니다.

3  또는  버튼을 눌러 수신 문자함으로 이동합니다.  버튼을 눌러 선택합니다.

4  또는  버튼을 눌러 원하는 메시지로 이동합니다.  버튼을 눌러 선택합니다.

텔레메트리 상태 문자 메시지에는 회신할 수 없습니다.

디스플레이에 텔레메트리: <상태 문자 메시지>가 표시됩니다.

5 홈 화면으로 돌아가려면  버튼을 길게 누릅니다.

문자 메시지에 응답

다음 절차에 따라 무전기에서 문자 메시지에 응답합니다.

문자 메시지 수신 시:







- 디스플레이에 발신자의 별칭 또는 ID와 함께 알림 목록이 표시됩니다.
- 디스플레이에 **메시지** 아이콘이 표시됩니다.





주의:



PTT 버튼을 누르면 무전기에서 문자 메시지 경보 화면이 종료되고 메시지의 발신자에 대한 개별 또는 그룹 호출이 설정됩니다.

1 다음 중 하나를 수행합니다.

-  또는  버튼을 눌러 읽기로 이동합니다.
 버튼을 눌러 선택합니다.
디스플레이에 문자 메시지가 표시됩니다. 이메일 응용 프로그램에서 메시지를 보낸 경우에는 제목 줄이 표시됩니다.
-  또는  버튼을 눌러 나중에 읽기로 이동합니다.  버튼을 눌러 선택합니다.
무전기가 문자 메시지 수신 이전 화면으로 돌아갑니다.

-  또는  버튼을 눌러 삭제로 이동합니다.
 버튼을 눌러 선택합니다.

2 다음 중 하나를 수행합니다.

- 수신함으로 돌아가려면  을 누릅니다.
- 문자 메시지를 회신, 전달 또는 삭제하려면  버튼을 누 번 누릅니다.

단축 문자를 사용하여 문자 메시지에 회신

다음 절차에 따라 무전기에서 단축 문자를 사용하여 문자 메시지에 회신합니다.

1 다음 중 하나를 수행합니다.

- 프로그래밍된 **문자 메시지** 버튼을 누릅니다. **단계 3** 단계로 이동합니다.
-  버튼을 눌러 메뉴로 이동합니다.

- ### 2 또는 버튼을 눌러 메시지로 이동합니다. 버튼을 눌러 선택합니다.



- ### 3 또는 버튼을 눌러 수신 문자함으로 이동합니다. 버튼을 눌러 선택합니다.

- ### 4 또는 버튼을 눌러 원하는 메시지로 이동합니다. 버튼을 눌러 선택합니다. 이메일 응용 프로그램에서 메시지를 보낸 경우에는 제목 줄이 표시됩니다.

- ### 5 버튼을 눌러 하위 메뉴로 이동합니다.

- ### 6 또는 버튼을 눌러 회신으로 이동합니다. 버튼을 눌러 선택합니다.

- ### 7 또는 버튼을 눌러 단축 회신으로 이동합니다. 버튼을 눌러 선택합니다.

- 8  또는  버튼을 눌러 원하는 메시지로 이동합니다.  버튼을 눌러 선택합니다.
디스플레이에 전환 미니 알림이 표시되어 메시지가 전송 중임을 나타냅니다.

9 승인을 기다립니다.

성공 시:

- 신호음이 울립니다.
- 디스플레이에 선택 미니 알림이 표시됩니다.

실패 시:

- 신호음이 울립니다.
- 디스플레이에 해제 미니 알림이 표시됩니다.
- 무전기가 재전송 옵션 화면으로 돌아갑니다.

문자 메시지 재전송

다음 절차에 따라 무전기에서 문자 메시지를 재전송합니다.

재전송 옵션 화면에 있는 경우:

 버튼을 눌러 동일한 메시지를 동일한 가입자 또는 그룹 별칭이나 ID로 재전송합니다.

성공 시:

- 선택음이 울립니다.
- 디스플레이에 선택 미니 알림이 표시됩니다.



실패 시:



- 해제음이 울립니다.
- 디스플레이에 해제 미니 알림이 표시됩니다.
- 무전기가 재전송 옵션 화면으로 돌아갑니다.

문자 메시지 전달

다음 절차에 따라 무전기에서 문자 메시지를 전달합니다.

재전송 옵션 화면에 있는 경우:

- 1  또는  버튼을 눌러 전달로 이동하고  버튼을 눌러 다른 가입자나 그룹 별칭 또는 ID로 동일한 메시지를 전송합니다.

- 2  또는  버튼을 눌러 원하는 별칭 또는 ID로 이동합니다.  버튼을 눌러 선택합니다.
디스플레이에 전환 미니 알림이 표시되어 메시지가 전송 중임을 나타냅니다.

3 승인을 기다립니다.

성공 시:

- 선택음이 울립니다.
- 디스플레이에 선택 미니 알림이 표시됩니다.

실패 시:

- 해제음이 울립니다.
- 디스플레이에 해제 미니 알림이 표시됩니다.











주의:

또한 대상 무전기 주소를 수동으로 선택할 수도 있습니다([매뉴얼 다이얼을 사용하여 문자 메시지 전달 페이지의 409](#) 참조).

매뉴얼 다이얼을 사용하여 문자 메시지 전달



다음 절차에 따라 무전기의 매뉴얼 다이얼을 사용하여 문자 메시지를 전달합니다.

- 1  또는  버튼을 눌러 전달로 이동합니다.
 버튼을 눌러 선택합니다.
- 2  버튼을 눌러 다른 가입자나 그룹 별칭 또는 ID로 동일한 메시지를 전송합니다.
- 3  또는  버튼을 눌러 매뉴얼 다이얼로 이동합니다.  버튼을 눌러 선택합니다.
디스플레이에 무전기 번호:가 표시됩니다.
- 4 가입자 ID를 입력하고  버튼을 눌러 계속합니다.
디스플레이에 전환 미니 알림이 표시되어 메시지가 전송 중임을 나타냅니다.

5 승인을 기다립니다.

성공 시:

- 신호음이 울립니다.
- 디스플레이에 선택 미니 알림이 표시됩니다.

실패 시:

- 신호음이 울립니다.
- 디스플레이에 해제 미니 알림이 표시됩니다.

- 왼쪽으로 한 칸 이동하려면 ◀ 버튼을 누릅니다.
- 오른쪽으로 한 칸 이동하려면 ▶ 또는 (F5) 버튼을 누릅니다.
- 필요 없는 문자를 삭제하려면 (*<) 버튼을 누릅니다.
- 문자 입력 방법을 변경하려면 (F6) 버튼을 길게 누릅니다.

문자 메시지 편집

메시지를 편집하려면 편집을 선택합니다.



주의:

이메일 응용 프로그램에서 수신한 메시지의 제목 줄 (있는 경우)은 편집할 수 없습니다.

- 1 ▲ 또는 ▼ 버튼을 눌러 편집합니다. (F4) 버튼을 눌러 선택합니다.
디스플레이에 커서가 깜박입니다.
- 2 키패드를 사용하여 메시지를 편집합니다.

- 3 메시지를 작성했으면 (F5) 버튼을 누릅니다.

4 다음 중 하나를 수행합니다.



- ▲ 또는 ▼ 을 눌러 전송으로 이동하고 (F4) 을 눌러 메시지를 전송합니다.
- ▲ 또는 ▼ 을 눌러 저장으로 이동하고 (F4) 을 눌러 임시 보관함 폴더에 메시지를 저장합니다.
- (F6) 을 눌러 메시지를 편집합니다.



-  을 눌러 메시지를 삭제하거나 임시 보관함 폴더로 저장합니다.

문자 메시지 작성

다음 절차에 따라 무전기에서 문자 메시지를 작성합니다.



- 1 다음 중 하나를 수행합니다.
 - 프로그래밍된 **문자 메시지** 버튼을 누릅니다. **단계 3**로 진행합니다.
 -  버튼을 눌러 메뉴로 이동합니다.

- 2  또는  버튼을 눌러 메시지로 이동합니다.
 버튼을 눌러 선택합니다.

- 3  또는  버튼을 눌러 작성으로 이동합니다.
 버튼을 눌러 선택합니다.
깜박이는 커서가 나타납니다.

- 4 키패드를 사용하여 메시지를 입력합니다.





왼쪽으로 한 칸 이동하려면  버튼을 누릅니다.

오른쪽으로 한 칸 이동하려면  또는  버튼을 누릅니다.

필요 없는 문자를 삭제하려면  버튼을 누릅니다.

문자 입력 방법을 변경하려면  버튼을 길게 누릅니다.

- 5 메시지를 작성했다면  버튼을 누릅니다.
다음 중 하나를 수행합니다.







-  버튼을 눌러 메시지를 보냅니다.
-  버튼을 누릅니다.  or  버튼을 눌러 메시지 편집, 삭제 또는 저장 중에서 선택하십시오.  버튼을 눌러 선택합니다.

문자 메시지 전송

다음 절차에 따라 무전기로 문자 메시지를 전송합니다.

새로 작성된 문자 메시지 또는 저장된 문자 메시지가 있다고 가정합니다.

메시지 수신자를 선택합니다. 다음 중 하나를 수행합니다.

-  또는  버튼을 눌러 원하는 별칭 또는 ID로 이동합니다.  버튼을 눌러 선택합니다.
-  또는  버튼을 눌러 매뉴얼 다이얼로 이동합니다.  버튼을 눌러 선택합니다. 가입자 ID를 입력합니다. 디스플레이의 첫 번째 줄에 무전기 번호:가 표시되고, 디스플레이의 두 번째 줄에 커서가 깜박입니다. 가입자 별칭이나 ID를 입력합니다.  를 누릅니다.

디스플레이에 전환 미니 알림이 표시되어 메시지가 전송 중임을 나타냅니다.

성공 시:

- 신호음이 울립니다.
- 디스플레이에 선택 미니 알림이 표시됩니다.

실패 시:

- 낮은 신호음이 울립니다.

- 디스플레이에 해제 미니 알림이 표시됩니다.
- 메시지가 보낸 문자함 폴더로 이동합니다.
- 메시지에 전송 실패 아이콘이 표시됩니다.



주의:

새로 작성한 문자 메시지의 경우 무전기가 재전송 옵션 화면으로 돌아갑니다.



수신 문자함의 문자 메시지 삭제

다음 절차에 따라 무전기에서 수신 문자함의 문자 메시지를 삭제합니다.

1 다음 중 하나를 수행합니다.

- 프로그래밍된 **문자 메시지** 버튼을 누릅니다. 단계 3로 진행합니다.
-  버튼을 눌러 메뉴로 이동합니다.

2

-  또는  버튼을 눌러 메시지로 이동합니다.  버튼을 눌러 선택합니다.

3 ▲ 또는 ▼ 버튼을 눌러 수신 문자함으로 이동합니다. [OK] 버튼을 눌러 선택합니다.

수신 문자함이 비어 있는 경우:

- 디스플레이에 목록 비어 있음이 표시됩니다.
- 신호음이 울립니다.

4 ▲ 또는 ▼ 버튼을 눌러 원하는 메시지로 이동합니다. [OK] 버튼을 눌러 선택합니다.

이메일 응용 프로그램에서 메시지를 보낸 경우에는 제목 줄이 표시됩니다.

5 [OK] 버튼을 눌러 하위 메뉴로 이동합니다.

6 ▲ 또는 ▼ 버튼을 눌러 삭제로 이동합니다. [OK] 버튼을 눌러 선택합니다.

7 ▲ 또는 ▼ 버튼을 눌러 예를 선택합니다. [OK] 버튼을 눌러 선택합니다.

디스플레이에 선택 미나 알림이 표시됩니다. 화면이 수신 문자함으로 돌아갑니다.

수신 문자함의 모든 문자 메시지 삭제 ●

다음 절차에 따라 무전기에서 수신 문자함의 모든 문자 메시지를 삭제합니다.

1 다음 중 하나를 수행합니다.



- 프로그래밍된 **문자 메시지** 버튼을 누릅니다. 단계 3로 진행합니다.
- [OK] 버튼을 눌러 메뉴로 이동합니다.



2 ▲ 또는 ▼ 버튼을 눌러 메시지로 이동합니다. [OK] 버튼을 눌러 선택합니다.

3 ▲ 또는 ▼ 버튼을 눌러 수신 문자함으로 이동합니다. [OK] 버튼을 눌러 선택합니다.

수신 문자함이 비어 있는 경우:

- 디스플레이에 목록 비어 있음이 표시됩니다.
- 신호음이 울립니다.

4  또는  버튼을 눌러 전체 삭제로 이동합니다.  버튼을 눌러 선택합니다.

5  또는  버튼을 눌러 예를 선택합니다.  버튼을 눌러 선택합니다.
디스플레이에 선택 미니 알림이 표시됩니다.

전송한 문자 메시지 ●

다른 무전기로 전송된 메시지는 보낸 문자함 폴더에 저장됩니다. 최근에 전송한 문자 메시지는 항상 보낸 문자함 폴더 맨 위에 추가됩니다. 전송한 문자 메시지를 재전송, 전달, 편집 또는 삭제할 수 있습니다.

보낸 문자함 폴더에는 최근에 전송한 메시지를 최대 30통 저장할 수 있습니다. 폴더가 다 차면 다음에 전송한 문자 메시지가 폴더에서 가장 오래된 문자 메시지를 자동으로 대체합니다.

메시지를 전송하는 중에 메시지 전송 화면을 종료하면 디스플레이에 표시가 나타나거나 경보음이 울리지 않고 무전기는 보낸 문자함 폴더의 메시지 상태를 업데이트합니다.

보낸 문자함 폴더의 메시지 상태를 업데이트하기 전에 무전기 모드가 변경되거나 전원이 꺼지면 무전기에서 진행 중인 메시지를 완료할 수 없으며 메시지에 **전송 실패** 아이콘이 자동으로 표시됩니다.

무전기는 한 번에 최대 5개의 진행 중 메시지를 지원합니다. 이 작업을 진행하는 안에는 무전기에서 새 메시지를 전송할 수 없으며 해당 새 메시지에 **전송 실패** 아이콘이 자동으로 표시됩니다.

언제든지  를 길게 누르면 무전기가 홈 화면으로 돌아갑니다.







주의:
채널 유형(예: 컨벤셔널 디지털, **Capacity Plus** 채널)이 일치하지 않으면 전송 메시지를 편집, 전달 또는 삭제만 할 수 있습니다.



전송한 문자 메시지 보기 ●



다음 절차에 따라 무전기에서 전송한 문자 메시지를 봅니다.

- 1 다음 중 하나를 수행합니다.

- 프로그래밍된 **문자 메시지** 버튼을 누릅니다. 단계 3로 진행합니다.
-  버튼을 눌러 메뉴로 이동합니다.

- 2  또는  버튼을 눌러 메시지로 이동합니다.
 버튼을 눌러 선택합니다.





- 3  또는  버튼을 눌러 보낸 문자함으로 이동합니다.  버튼을 눌러 선택합니다.
보낸 문자함 폴더가 비어 있는 경우:
- 디스플레이에 목록 비어 있음이 표시됩니다.
 - 키패드 신호음이 켜져 있는 경우 낮은 신호음이 울립니다.

- 4  또는  버튼을 눌러 원하는 메시지로 이동합니다.  버튼을 눌러 선택합니다.
화면 오른쪽 위에 있는 아이콘은 메시지 상태를 나타냅니다. **보낸 문자함 아이콘**를 참조하십시오.

전송한 문자 메시지 전송

다음 절차에 따라 무전기에서 전송한 문자 메시지를 전송합니다.

전송한 메시지를 볼 때:

- 1 메시지를 보는 동안  을 누릅니다.
- 2 전송한 문자 메시지를 재전송하거나 전달할 수 있습니다. 다음 중 하나를 수행합니다.
 -  을 눌러 재전송으로 이동합니다.  버튼을 눌러 선택합니다.
 -  을 눌러 전달로 이동합니다.  버튼을 눌러 선택합니다.

디스플레이에 전환 미나 알림이 표시되어 메시지가 전송 중임을 나타냅니다.

- 3 승인을 기다립니다.

성공 시:

- 선택음이 울립니다.
- 디스플레이에 선택 미나 알림이 표시됩니다.

실패 시:



- 해제음이 울립니다.
- 디스플레이에 해제 미니 알림이 표시됩니다.
- 무전기가 재전송 옵션 화면으로 이동합니다. 자세한 내용은 **문자 메시지 재전송 페이지의 139** 부분을 참조하십시오.

보낸 문자함 폴더에서 전송한 문자 메시지 삭제

다음 절차에 따라 무전기의 보낸 문자함 폴더에서 보낸 문자 메시지를 삭제합니다.

전송한 메시지를 볼 때:

1  를 누릅니다.



2  또는  버튼을 눌러 삭제로 이동합니다.
 버튼을 눌러 선택합니다.



보낸 문자함 폴더에서 전송한 모든 문자 메시지 삭제

다음 절차에 따라 무전기의 보낸 문자함 폴더에서 보낸 모든 문자 메시지를 삭제합니다.

1 다음 중 하나를 수행합니다.



- 프로그래밍된 **문자 메시지** 버튼을 누릅니다. 단계 3로 진행합니다.
 -  버튼을 눌러 메뉴로 이동합니다.
-

2  또는  버튼을 눌러 메시지로 이동합니다.
 버튼을 눌러 선택합니다.







3  또는  버튼을 눌러 보낸 문자함으로 이동합니다.  버튼을 눌러 선택합니다.

보낸 문자함 폴더가 비어 있는 경우:

- 디스플레이에 목록 비어 있음이 표시됩니다.
 - 신호음이 울립니다.
-

- 4  또는  버튼을 눌러 전체 삭제로 이동합니다.  버튼을 눌러 선택합니다.

5 다음 중 하나를 수행합니다.

-  또는  버튼을 눌러 예를 선택합니다.  버튼을 눌러 선택합니다. 디스플레이에 선택 미니 알림이 표시됩니다.
-  또는  버튼을 눌러 아니오로 이동합니다.  버튼을 눌러 선택합니다. 무전기가 이전 화면으로 돌아갑니다.

저장된 문자 메시지

문자 메시지를 저장하고 나중에 전송할 수 있습니다.











문자 메시지를 작성하거나 편집하는 동안 **PTT** 버튼을 누르거나 모드를 변경하여 무전기에서 문자 메시지 작성/편집 화면이 종료되는 경우, 현재 문자 메시지는 자동으로 임시보관함 폴더에 저장됩니다.

최근에 전송한 문자 메시지가 항상 임시보관함 목록 맨 위에 추가됩니다.

초안 폴더에는 최근에 저장한 메시지가 최대 10개까지 저장됩니다. 폴더가 다 차면 다음에 저장한 문자 메시지가 폴더에서 가장 오래된 문자 메시지를 자동으로 대체합니다.

저장된 문자 메시지 보기



다음 절차에 따라 무전기에서 저장된 문자 메시지를 봅니다.





- 1 다음 중 하나를 수행합니다.
 - 프로그래밍된 **문자 메시지** 버튼을 누릅니다. **단계 3**로 진행합니다.
 -  버튼을 눌러 메뉴로 이동합니다.
- 2  또는  버튼을 눌러 메시지로 이동합니다.  버튼을 눌러 선택합니다.
- 3  또는  버튼을 눌러 임시보관함으로 이동합니다.  버튼을 눌러 선택합니다.
- 4  또는  버튼을 눌러 원하는 메시지로 이동합니다.  버튼을 눌러 선택합니다.

저장된 문자 메시지 편집







다음 절차에 따라 무전기에서 저장된 문자 메시지를 편집합니다.

- 1 메시지를 보는 동안  을 누릅니다.

- 2  또는  버튼을 눌러 편집합니다.  버튼을 눌러 선택합니다.
깜박이는 커서가 나타납니다.

- 3 키패드를 사용하여 메시지를 입력합니다.
왼쪽으로 한 칸 이동하려면  버튼을 누릅니다.
오른쪽으로 한 칸 이동하려면  또는  버튼을 누릅니다.
필요 없는 문자를 삭제하려면  버튼을 누릅니다.
문자 입력 방법을 변경하려면  버튼을 길게 누릅니다.



- 4 메시지를 작성했으면  버튼을 누릅니다.
다음 중 하나를 수행합니다.

-  또는  을 눌러 전송으로 이동합니다.
 버튼을 눌러 메시지를 보냅니다.
-  를 누릅니다.  또는  버튼을 눌러 메시지를 저장하거나 삭제합니다.  버튼을 눌러 선택합니다.



임시 보관함 폴더에 저장된 문자 메시지 삭제

다음 절차에 따라 무전기에서 임시 보관함에 저장된 문자 메시지를 삭제합니다.



- 1 다음 중 하나를 수행합니다.
 - 프로그래밍된 **문자 메시지** 버튼을 누릅니다. **단계 3**로 진행합니다.
 -  버튼을 눌러 메뉴로 이동합니다.

2  또는  버튼을 눌러 메시지로 이동합니다.



 버튼을 눌러 선택합니다.

3  또는  버튼을 눌러 임시보관함으로 이동

합니다.  버튼을 눌러 선택합니다.

4  또는  버튼을 눌러 원하는 메시지로 이동

합니다.  버튼을 눌러 선택합니다.

5  또는  버튼을 눌러 삭제로 이동합니다.

 을 눌러 문자 메시지를 삭제합니다.

단축 문자 메시지

무전기는 대리점에서 프로그래밍된 대로 최대 50개의 단축 문자 메시지를 지원합니다.

단축 문자 메시지를 미리 정의한 경우 전송하기 전에 각 메시지를 편집할 수 있습니다.

단축 문자 메시지 전송

다음 절차에 따라 무전기에서 사전 정의된 별칭으로 사전 정의된 단축 문자 메시지를 전송합니다.



1 다음 중 하나를 수행합니다.

- 프로그래밍된 **문자 메시지** 버튼을 누릅니다. **단계 6**로 진행합니다.



- 프로그래밍된 **원터치 액세스** 버튼을 누릅니다. 디스플레이에 전환 미니 알림이 표시되어 메시지가 전송 중임을 나타냅니다.

단계 6로 진행합니다.



-  버튼을 눌러 메뉴로 이동합니다.

2  또는  버튼을 눌러 메시지로 이동합니다.

 버튼을 눌러 선택합니다.

3  또는  버튼을 눌러 단축 문자로 이동합니

다.  버튼을 눌러 선택합니다.

4  또는  버튼을 눌러 원하는 단축 문자 메시지로 이동합니다.  버튼을 눌러 선택합니다.

5 다음을 수행하여 수신자를 선택하고 메시지를 전송합니다.

디스플레이에 전환 미니 알림이 표시되어 메시지가 전송 중임을 나타냅니다.

6 승인을 기다립니다.

성공 시:

- 선택음이 울립니다.
- 디스플레이에 선택 미니 알림이 표시됩니다.

실패 시:

- 해제음이 울립니다.
- 디스플레이에 해제 미니 알림이 표시됩니다.
- 무전기가 재전송 옵션 화면으로 이동합니다. 자세한 내용은 [문자 메시지 재전송 페이지의 139](#) 부분을 참조하십시오.

텍스트 입력 구성

무전기에서 다른 문자를 구성할 수 있습니다.

무전기에서 다음과 같은 텍스트 입력 설정을 구성할 수 있습니다.



- 단어 예측
- 단어 교정
- 대문자
- 나의 단어

무전기에서는 다음 텍스트 입력 방법을 지원합니다.

- 숫자
- 기호
- 자동 완성 또는 여러 번 누름
- 언어(프로그래밍된 경우)







주의:



이전 화면으로 돌아가려면 언제든지  버튼을 누르고, 홈 화면으로 돌아가려면  버튼을 길게 누릅니다. 무전기는 비활성 타이머가 만료되는 즉시 현재 화면을 종료합니다.



단어교정 기능 활성화 또는 비활성화



텍스트 편집기에 입력한 단어가 내장된 사전에 없는 경우 대체 단어 옵션을 제공합니다.

- 1  버튼을 눌러 메뉴로 이동합니다.





- 2  또는  버튼을 눌러 유틸리티로 이동합니다.  버튼을 눌러 선택합니다.

- 3  또는  버튼을 눌러 무전기 설정으로 이동합니다.  버튼을 눌러 선택합니다.

- 4  또는  버튼을 눌러 문자 입력으로 이동합니다.  버튼을 눌러 선택합니다.

- 5  또는  버튼을 눌러 단어 교정으로 이동합니다.  버튼을 눌러 선택합니다.



- 6 다음 중 하나를 수행합니다.



-  또는  버튼을 눌러 단어 교정으로 이동합니다.  버튼을 눌러 선택합니다.
- 버튼을 눌러 단어 교정 기능을 활성화합니다. 활성화되면  아이콘이 활성화 옆에 표시됩니다.
- 버튼을 눌러 단어 교정 기능을 비활성화합니다. 비활성화되면  아이콘이 활성화 옆에서 사라집니다.



단어 예측 활성화 또는 비활성화



단어 예측: 무전기는 사용자가 자주 입력하는 흔하게 사용되는 단어 시퀀스를 기억할 수 있습니다. 이 기능을 통해 사용자가 흔하게 사용되는 단어 시퀀스 중 첫 번째 단어를 텍스트 편집기에 입력하면 다음에 입력할 단어를 무전기가 자동으로 예측할 수 있습니다.

- 1  버튼을 눌러 메뉴로 이동합니다.





- 2  또는  버튼을 눌러 유틸리티로 이동합니다.  버튼을 눌러 선택합니다.

3  또는  버튼을 눌러 무전기 설정으로 이동합니다.  버튼을 눌러 선택합니다.

4  또는  버튼을 눌러 문자 입력으로 이동합니다.  버튼을 눌러 선택합니다.

5  또는  을 눌러 단어 예측으로 이동합니다.  버튼을 눌러 선택합니다.



6 다음 중 하나를 수행합니다.



-  버튼을 눌러 단어 예측 기능을 활성화합니다. 활성화되면  아이콘이 활성화 옆에 표시됩니다.
 -  을 눌러 마이크 동적 왜곡 컨트롤을 비활성화합니다. 비활성화되면  아이콘이 활성화 옆에서 사라집니다.
-



대문자



이 기능은 문장을 새로 시작할 때 첫 번째 단어의 첫 문자를 자동으로 대문자로 표시할 때 사용됩니다.

1  버튼을 눌러 메뉴로 이동합니다.





2  또는  버튼을 눌러 유틸리티로 이동합니다.  버튼을 눌러 선택합니다.

3  또는  버튼을 눌러 무전기 설정으로 이동합니다.  버튼을 눌러 선택합니다.

4  또는  버튼을 눌러 문자 입력으로 이동합니다.  버튼을 눌러 선택합니다.







5  또는  버튼을 눌러 대문자로 이동합니다.  버튼을 눌러 선택합니다.



6 다음 중 하나를 수행합니다.



-  버튼을 눌러 대문자 기능을 활성화합니다. 활성화되면  아이콘이 활성화 옆에 표시됩니다.
-  버튼을 눌러 대문자 기능을 비활성화합니다. 비활성화되면  아이콘이 활성화 옆에서 사라집니다.



사용자 지정 단어 보기

무전기의 내장된 사전에 사용자 지정 단어를 추가할 수 있습니다. 무전기에는 이러한 사용자 지정 단어를 저장하는 목록이 포함되어 있습니다.

- 1  버튼을 눌러 메뉴로 이동합니다.
- 2  또는  버튼을 눌러 유틸리티로 이동합니다.  버튼을 눌러 선택합니다.
- 3  또는  버튼을 눌러 무전기 설정으로 이동합니다.  버튼을 눌러 선택합니다.





- 4  또는  버튼을 눌러 문자 입력으로 이동합니다.  버튼을 눌러 선택합니다.



- 5  또는  버튼을 눌러 내 단어로 이동합니다.  버튼을 눌러 선택합니다.



- 6  또는  을 눌러 단어 목록으로 이동합니다.  버튼을 눌러 선택합니다. 디스플레이에 사용자 지정 단어 목록이 표시됩니다.



사용자 지정 단어 편집



무전기에 저장된 사용자 지정 단어를 편집할 수 있습니다.



- 1  버튼을 눌러 메뉴로 이동합니다.
- 2  또는  버튼을 눌러 유틸리티로 이동합니다.  버튼을 눌러 선택합니다.



3  또는  버튼을 눌러 무전기 설정으로 이동합니다.  버튼을 눌러 선택합니다.

4  또는  버튼을 눌러 문자 입력으로 이동합니다.  버튼을 눌러 선택합니다.





5  또는  버튼을 눌러 내 단어로 이동합니다.  버튼을 눌러 선택합니다.

6  또는  을 눌러 단어 목록으로 이동합니다.  버튼을 눌러 선택합니다.
디스플레이에 사용자 지정 단어 목록이 표시됩니다.

7  또는  을 눌러 원하는 단어로 이동합니다.  버튼을 눌러 선택합니다.

8  또는  을 눌러 편집으로 이동합니다.  버튼을 눌러 선택합니다.

9 키패드로 사용자 지정 단어를 편집합니다.

- 왼쪽으로 한 칸 이동하려면  버튼을 누릅니다.
 - 오른쪽으로 한 칸 이동하려면  키를 누릅니다.
 - 필요 없는 문자를 삭제하려면  키를 누릅니다.
 - 문자 입력 방법을 변경하려면  버튼을 길게 누릅니다.
-

10 사용자 지정 단어를 완성한 후  버튼을 누릅니다.



디스플레이에 전환 미니 알림이 표시되어 사용자 지정 단어가 저장 중임을 나타냅니다.



- 사용자 지정 단어가 저장되면 경보음이 울리고 디스플레이에 선택 미니 알림이 표시됩니다.
- 사용자 지정 단어가 저장되지 않으면 낮은 경보음이 울리고 디스플레이에 해제 미니 알림이 표시됩니다.



사용자 지정 단어 추가



무전기에 내장된 사전에 사용자 지정 단어를 추가할 수 있습니다.



- 1  버튼을 눌러 메뉴로 이동합니다.





- 2  또는  버튼을 눌러 유틸리티로 이동합니다.  버튼을 눌러 선택합니다.

- 3  또는  버튼을 눌러 무전기 설정으로 이동합니다.  버튼을 눌러 선택합니다.

- 4  또는  버튼을 눌러 문자 입력으로 이동합니다.  버튼을 눌러 선택합니다.

- 5  또는  버튼을 눌러 내 단어로 이동합니다.  버튼을 눌러 선택합니다.

- 6  또는  을 눌러 새 단어 추가로 이동합니다.  버튼을 눌러 선택합니다.
디스플레이에 사용자 지정 단어 목록이 표시됩니다.

- 7 키패드로 사용자 지정 단어를 편집합니다.
 - 왼쪽으로 한 칸 이동하려면  버튼을 누릅니다.
 - 오른쪽으로 한 칸 이동하려면  키를 누릅니다.
 - 필요 없는 문자를 삭제하려면  키를 누릅니다.
 - 문자 입력 방법을 변경하려면  버튼을 길게 누릅니다.

- 8 사용자 지정 단어를 완성한 후  버튼을 누릅니다.

디스플레이에 전환 미니 알림이 표시되어 사용자 지정 단어가 저장 중임을 나타냅니다.



- 사용자 지정 단어가 저장되면 경보음이 울리고 디스플레이에 선택 미니 알림이 표시됩니다.



- 사용자 지정 단어가 저장되지 않으면 낮은 경보음이 울리고 디스플레이에 해제 미니 알림이 표시됩니다.



사용자 지정 단어 삭제



다음 절차에 따라 무전기에 저장된 사용자 지정 단어를 삭제합니다.



- 1  버튼을 눌러 메뉴로 이동합니다.

- 2  또는  버튼을 눌러 유틸리티로 이동합니다.  버튼을 눌러 선택합니다.



- 3  또는  버튼을 눌러 무전기 설정으로 이동합니다.  버튼을 눌러 선택합니다.

- 4  또는  버튼을 눌러 문자 입력으로 이동합니다.  버튼을 눌러 선택합니다.

- 5  또는  버튼을 눌러 내 단어로 이동합니다.  버튼을 눌러 선택합니다.





- 6  또는  을 눌러 원하는 단어로 이동합니다.

 버튼을 눌러 선택합니다.

- 7  또는  버튼을 눌러 삭제로 이동합니다.

 버튼을 눌러 선택합니다.



- 8 다음 중 하나를 선택합니다.



- 항목 삭제?에서  을 눌러 예를 선택합니다. 디스플레이에 항목 삭제 완료가 표시됩니다.
-  또는  버튼을 눌러 아니오로 이동합니다. 이전 화면으로 돌아가려면  버튼을 누릅니다.



사용자 지정 단어 전체 삭제



다음 절차를 따라 무전기의 내장 사전에서 모든 사용자 지정 단어를 삭제합니다.



- 1  버튼을 눌러 메뉴로 이동합니다.

2  또는  버튼을 눌러 유틸리티로 이동합니다.  버튼을 눌러 선택합니다.

3  또는  버튼을 눌러 무전기 설정으로 이동합니다.  버튼을 눌러 선택합니다.



4  또는  버튼을 눌러 문자 입력으로 이동합니다.  버튼을 눌러 선택합니다.

5  또는  버튼을 눌러 내 단어로 이동합니다.  버튼을 눌러 선택합니다.

6  또는  버튼을 눌러 전체 삭제로 이동합니다.  버튼을 눌러 선택합니다.

7 다음 중 하나를 수행합니다.

- 항목 삭제?에서  을 눌러 예를 선택합니다. 디스플레이에 모든 항목 삭제 완료가 표시됩니다.

-  또는  버튼을 누르고 아니오를 선택하여 이전 화면으로 돌아갑니다.  버튼을 눌러 선택합니다.

작업 티켓

이 기능을 사용하면 수행할 작업이 나열된 디스패치의 메시지를 받을 수 있습니다.



주의:

이 기능은 사용자 요구 사항에 따라 CPS를 통해 지정할 수 있습니다. 자세한 내용은 대리점이나 시스템 관리자에게 문의하십시오.

다음과 같이 서로 다른 작업 티켓을 포함하는 두 개의 폴더가 있습니다.

내 작업 폴더

로그인한 사용자 ID에 지정된 개인 작업 티켓.

공유 작업 폴더

개인 그룹에 할당된 공유 작업 티켓.

작업 티켓을 작업 티켓 폴더로 정렬하기 위해 작업 티켓에 응답할 수 있습니다. 기본적으로 작업 티켓 폴더는 **전체**, **신규**, **시작됨** 및 **완료됨**입니다. 10개의 추가 폴더에 대해서는 대리점이나 시스템 관리자에게 문의하십시오.

**주의:**

작업 티켓은 무전기를 켜다가 다시 켜 후에도 유지됩니다.

모든 작업 티켓은 **모든 폴더**에 있습니다. 무전기가 프로그램밍된 방식에 따라, 작업 티켓은 우선순위 레벨에 따라 정렬된 다음, 수신된 시간을 기준으로 정렬됩니다. 새로운 작업 티켓, 최근 상태 변경이 있는 작업 티켓, 우선순위가 가장 높은 작업 티켓이 먼저 나열됩니다. 최대 작업 티켓 수에 도달하면 무전기의 마지막 작업 티켓이 다음 작업 티켓으로 자동으로 바뀝니다. 무전기는 모델에 따라 최대 100개 또는 500개의 작업 티켓을 지원합니다. 자세한 내용은 대리점이나 시스템 관리자에게 문의하십시오. 무전기는 작업 티켓 ID가 같은 중복된 작업 티켓을 자동으로 감지하고 취소합니다.

작업 티켓의 중요성에 따라 디스패처는 작업 티켓에 우선순위 레벨을 추가합니다. 다음과 같은 세 가지 우선순위 레벨이 있습니다. 우선순위 1, 우선순위 2 및 우선순위 3. 우선순위 1이 가장 높은 우선순위이고 우선순위 3이 가장 낮은 우선순위입니다. 우선순위가 없는 작업 티켓도 있습니다.



디스패처가 다음과 같이 변경하면 무전기가 업데이트됩니다.



- 작업 티켓의 내용을 수정합니다.
- 작업 티켓의 우선순위 레벨을 추가하거나 편집합니다.
- 작업 티켓을 폴더에서 폴더로 이동합니다.
- 작업 티켓을 취소합니다.



작업 티켓 폴더에 액세스

다음 절차에 따라 작업 티켓 폴더에 액세스합니다.

- 1 다음 중 하나를 수행합니다.
 - 프로그래밍된 **작업 티켓** 버튼을 누릅니다. **단계 3**로 진행합니다.
 -  버튼을 눌러 메뉴로 이동합니다.

- 2  또는  을 눌러 작업 티켓으로 이동합니다.  버튼을 눌러 선택합니다.



- 3  또는  을 눌러 원하는 폴더로 이동합니다.  버튼을 눌러 선택합니다.

- 4  또는  을 눌러 원하는 작업 티켓으로 이동합니다.  버튼을 눌러 선택합니다.

원격 서버의 로그인 또는 로그아웃

이 기능을 사용하면 사용자 ID를 사용하여 원격 서버에 로그인하고 로그아웃할 수 있습니다.

- 1  버튼을 눌러 메뉴로 이동합니다.

- 2  또는  을 눌러 로그인으로 이동합니다.
 버튼을 눌러 선택합니다.
이미 로그인한 경우 메뉴에 로그아웃이 표시됩니다.
디스플레이에 전환 미니 알림이 표시되어 요청이 진행 중임을 나타냅니다.



- 3 승인을 기다립니다.
성공 시:
 - 선택음이 울립니다.
 - 디스플레이에 선택 미니 알림이 표시됩니다.
 실패 시:
 - 해제음이 울립니다.
 - 디스플레이에 해제 미니 알림이 표시됩니다.



작업 티켓 작성

무전기에서 작업 티켓을 작성할 수 있습니다. 작업 티켓은 작업 티켓 템플릿에 기반하며, 수행해야 하는 작업을 전송합니다.

작업 티켓 템플릿을 구성하려면 CPS 프로그래밍 소프트웨어가 필요합니다.

- 1  버튼을 눌러 메뉴로 이동합니다.



- 2  또는  을 눌러 작업 티켓으로 이동합니다.
 버튼을 눌러 선택합니다.

- 3  또는  버튼을 눌러 티켓 작성으로 이동합니다.  버튼을 눌러 선택합니다.



작업 티켓에 응답

다음 절차에 따라 무전기에서 작업 티켓에 응답합니다.



- 1  버튼을 눌러 메뉴로 이동합니다.

2  또는  을 눌러 작업 티켓으로 이동합니다.



 버튼을 눌러 선택합니다.

3  또는  을 눌러 원하는 폴더로 이동합니다.

 버튼을 눌러 선택합니다.

4  또는  을 눌러 원하는 작업 티켓으로 이동합니다.  버튼을 눌러 선택합니다.

5  버튼을 한 번 더 눌러 하위 메뉴로 이동합니다. 해당 숫자 키(1-9)를 눌러 **단축 회신**으로 이동할 수도 있습니다.

6  또는  을 눌러 원하는 작업 티켓으로 이동합니다.  버튼을 눌러 선택합니다.

디스플레이에 전환 미니 알림이 표시되어 요청이 진행 중임을 나타냅니다.

7 승인을 기다립니다.

성공 시:

- 선택음이 울립니다.
- 디스플레이에 선택 미니 알림이 표시됩니다.



실패 시:



- 해제음이 울립니다.
- 디스플레이에 해제 미니 알림이 표시됩니다.



하나의 작업 티켓 템플릿을 사용하여 작업 티켓 전송

하나의 작업 티켓 템플릿으로 무전기를 구성한 경우 다음 작업을 수행하여 작업 티켓을 전송합니다.

1 키패드를 사용하여 원하는 호실을 입력합니다.  버튼을 눌러 선택합니다.

2  또는  을 눌러 방 상태로 이동합니다.  버튼을 눌러 선택합니다.

3  또는  버튼을 눌러 원하는 옵션으로 이동합니다.  버튼을 눌러 선택합니다.

- 4  또는  을 눌러 전송으로 이동합니다.  버튼을 눌러 선택합니다.

디스플레이에 전환 미니 알림이 표시되어 요청이 진행 중임을 나타냅니다.

- 5 승인을 기다립니다.

성공 시:



- 선택음이 울립니다.
- 디스플레이에 선택 미니 알림이 표시됩니다.



실패 시:

- 해제음이 울립니다.
- 디스플레이에 해제 미니 알림이 표시됩니다.

둘 이상의 작업 티켓 템플릿을 사용하여 작업 티켓 전송

둘 이상의 작업 티켓 템플릿으로 무전기를 구성했다면 다음 작업을 수행하여 작업 티켓을 전송합니다.

- 1  또는  버튼을 눌러 원하는 옵션으로 이동합니다.  버튼을 눌러 선택합니다.

- 2  또는  을 눌러 전송으로 이동합니다.  버튼을 눌러 선택합니다.

디스플레이에 전환 미니 알림이 표시되어 요청이 진행 중임을 나타냅니다.

- 3 승인을 기다립니다.

성공 시:

- 선택음이 울립니다.
- 디스플레이에 선택 미니 알림이 표시됩니다.



실패 시:



- 해제음이 울립니다.
- 디스플레이에 해제 미니 알림이 표시됩니다.



작업 티켓 삭제



다음 절차에 따라 무전기에서 작업 티켓을 삭제합니다.

- 1 다음 중 하나를 수행합니다.
 - 프로그래밍된 **작업 티켓** 버튼을 누릅니다. **단계 4**로 진행합니다.
 -  버튼을 눌러 메뉴로 이동합니다.



- 2  또는  을 눌러 작업 티켓으로 이동합니다.  버튼을 눌러 선택합니다.

- 3  또는  을 눌러 원하는 폴더로 이동합니다.  버튼을 눌러 선택합니다.

- 4  또는  버튼을 눌러 모든 폴더로 이동합니다.  버튼을 눌러 선택합니다.

- 5  또는  을 눌러 원하는 작업 티켓으로 이동합니다.  버튼을 눌러 선택합니다.

- 6 작업 티켓을 보는 동안  버튼을 다시 한 번 누릅니다.

- 7  또는  버튼을 눌러 삭제로 이동합니다.

 버튼을 눌러 선택합니다.

디스플레이에 전환 미니 알림이 표시되어 요청이 진행 중임을 나타냅니다.

- 8 승인을 기다립니다.

성공 시:

- 선택음이 울립니다.
- 디스플레이에 선택 미니 알림이 표시됩니다.

실패 시:



- 해제음이 울립니다.
- 디스플레이에 해제 미니 알림이 표시됩니다.

모든 작업 티켓 삭제



다음 절차에 따라 무전기에서 모든 작업 티켓을 삭제합니다.

- 1 다음 중 하나를 수행합니다.
 - 프로그래밍된 **작업 티켓** 버튼을 누릅니다. **단계 3**로 진행합니다.



-  버튼을 눌러 메뉴로 이동합니다.

- 2  또는  을 눌러 작업 티켓으로 이동합니다.



 버튼을 눌러 선택합니다.

- 3  또는  을 눌러 원하는 폴더로 이동합니다.

 버튼을 눌러 선택합니다.



- 4  또는  버튼을 눌러 모든 폴더로 이동합니

다.  버튼을 눌러 선택합니다.

- 5  또는  버튼을 눌러 전체 삭제로 이동합니



다.  버튼을 눌러 선택합니다.

- 6 다음 중 하나를 수행합니다.

-  또는  버튼을 눌러 예를 선택합니다.

 버튼을 눌러 선택합니다.

디스플레이에 선택 미니 알림이 표시됩니다.

-  또는  버튼을 눌러 아니오로 이동합니

다.  버튼을 눌러 선택합니다.

무전기가 이전 화면으로 돌아갑니다.

개인 정보 보호

이 기능은 무단 사용자가 소프트웨어 기반 스크램블링 솔루션을 사용하여 채널에서 도청하는 것을 방지할 수 있습니다. 전송에 대한 신호 및 사용자 ID 부분은 스크램블링되지 않습니다.

프라이버시 활성화 전송을 보내려면 채널상에서 무전기의 프라이버시가 활성화되어 있어야 하지만, 이는 전송을 수신하기 위한 필수 사항은 아닙니다. 프라이버시 활성화 채널에서는 무전기가 깨끗하고 스크램블링되지 않은 전송을 계속 수신할 수 있습니다.

일부 무전기 모델은 이러한 프라이버시 기능이 없거나 구성이 다를 수 있습니다. 자세한 내용은 대리점이나 시스템 관리자에게 문의하십시오.

무전기는 두 가지 프라이버시 유형을 지원하지만 하나만 무전기에 지정할 수 있습니다. 9개의 범주는 다음과 같습니다.

- 기본 프라이버시
- 향상된 개인 정보 보호

프라이버시 활성화 호출 또는 데이터 전송의 스크램블을 풀려면 발신 무전기와 동일한 프라이버시 키(기본 프라이버시용) 또는 동일한 키 값과 키 ID(고급 프라이버시용)를 사용하도록 무전기가 프로그래밍되어야 합니다.

무전기에서 다른 프라이버시 키 또는 다른 키 값과 키 ID를 사용한 스크램블링된 호출을 받는 경우에는 왜곡된 전송(기본 프라이버시)을 듣거나 아무것도 듣지 못합니다(고급 프라이버시).

프라이버시 활성화 채널에서는 무전기가 프로그래밍된 방식에 따라 무전기가 깨끗하거나 스크램블링되지 않은 호출을 수신할 수 있습니다. 또한 무전기가 프로그래밍된 방식에 따라 무전기가 경고음을 울리거나 울리지 않을 수도 있습니다.

무전기가 전송 중이면 녹색 LED가 켜지고 무전기가 진행 중인 프라이버시 사용 전송을 수신 중이면 녹색 LED가 빠르게 깜박입니다.



주의:

이 기능은 동일한 주파수에 있는 Citizens 대역 채널에는 적용되지 않습니다.

프라이버시 기능 켜기 또는 끄기

다음 절차에 따라 무전기에서 프라이버시 기능을 켜거나 끕니다.

- 1 다음 중 하나를 수행합니다.

- 프로그래밍된 **프라이버시** 버튼을 누릅니다. 아래 단계를 건너뛴니다.
- 버튼을 눌러 메뉴로 이동합니다.



- 2 또는 버튼을 눌러 유틸리티로 이동합니다. 버튼을 눌러 선택합니다.

- 3 또는 버튼을 눌러 무전기 설정으로 이동합니다. 버튼을 눌러 선택합니다.

- 4 또는 버튼을 눌러 프라이버시로 이동합니다. 버튼을 눌러 선택합니다.

- 5 다음 중 하나를 수행합니다.

- 또는 버튼을 눌러 켜기로 이동합니다. 버튼을 눌러 선택합니다. ✓가 디스플레이의 켜기 옆에 표시됩니다.

-  또는  버튼을 눌러 **끄기**로 이동합니다.
 버튼을 눌러 선택합니다. ✓가 디스플레이의 **끄기** 옆에 표시됩니다.

프로그래밍된 **응답 금지** 버튼을 누릅니다.

성공 시:

- 선택음이 울립니다.
- 디스플레이에 선택 미니 알림이 일시적으로 표시됩니다.

실패 시:

- 해제음이 울립니다.
- 디스플레이에 해제 미니 알림이 일시적으로 표시됩니다.

응답 금지

이 기능을 사용하면 수신되는 어떤 전송에도 무전기가 응답하지 않도록 해줍니다.



주의:

이 기능은 유료입니다. 무전기가 프로그래밍된 방식에 대해서는 대리점이나 시스템 관리자에게 문의하십시오.

이 기능을 사용하면 무전기에서 무전기 점검, 호출 경보, 무선 비활성화, 원격 모니터링, 자동 등록 서비스(ARS), 비공개 메시지 응답, GNSS 위치 보고서 전송 등과 같이 수신되는 전송에 응답하여 전송을 발송하지 않습니다. 이 기능을 사용하면 무전기가 확인된 개인 통화를 받지 않을 수 있습니다. 하지만 무전기에서 수동으로 전송 내역을 보낼 수 있습니다.

응답 금지 켜기 또는 끄기

다음 절차에 따라 무전기의 응답 금지를 활성화하거나 비활성화할 수 있습니다.

멀티 사이트 컨트롤

현재 무전기 채널이 IP Site Connect 또는 Capacity Plus 다중 사이트 구성의 일부인 경우 이러한 기능을 사용할 수 있습니다.

수동 사이트 검색 시작

신호 강도가 약하여 신호가 더 좋은 사이트를 찾으려면 다음 절차에 따라 수동 사이트 검색을 시작합니다.

무전기가 새 사이트를 찾는 경우:

- 선택음이 울립니다.

무전기에서 새 사이트를 찾지 못한 경우:

- 해제음이 울립니다.

사이트 잠금 켜기/끄기

사이트 잠금을 켜면 무전기가 현재 사이트만 검색합니다. 사이트 잠금을 끄면 무전기가 현재 사이트에 추가로 다른 사이트를 검색합니다.

프로그래밍된 **사이트 잠금** 버튼을 누릅니다.

사이트 잠금 기능이 켜진 경우:

- 무전기가 현재 사이트로 잠기면 성공음이 울립니다.
- 디스플레이에 사이트 잠금 완료가 표시됩니다.



사이트 잠금 기능이 꺼진 경우:



- 무전기가 잠기지 않으면 해제음이 울립니다.
- 디스플레이에 사이트 해제 완료가 표시됩니다.



인접 사이트 목록에 액세스

사용자는 이 기능으로 현재 홈 사이트의 인접 사이트 목록을 확인할 수 있습니다. 다음 절차에 따라 인접 사이트 목록에 액세스합니다.

1  버튼을 눌러 메뉴로 이동합니다.

2  또는  버튼을 눌러 유틸리티로 이동합니다.  버튼을 눌러 선택합니다.

3  또는  을 눌러 무전기 정보로 이동합니다.  버튼을 눌러 선택합니다.

4  또는  을 눌러 인접 사이트로 이동합니다.  버튼을 눌러 선택합니다.

보안

이 기능을 사용하여 시스템의 무전기를 활성화하거나 비활성화할 수 있습니다.

예를 들어 도난된 무전기를 비활성화하여 무단 사용자가 사용하지 못하도록 하고 무전기를 되찾았을 때 활성화할 수 있습니다.

무전기를 활성화하거나 비활성화하는 방법에는 무전기의 인증 유무에 따라 2가지로 볼 수 있습니다.

인증된 무전기 비활성화는 유료로 사용할 수 있는 기능입니다. 인증된 무전기 비활성화 상태에서 무전기를 활성화하거나 비활성화할 때 확인이 필요합니다. 무전기가 사용자 인증이 설정된 대상 무전기에 이 기능을 실행할 때 암호구가 필요합니다. 암호구는 CPS를 통해 대상 무전기에서 미리 프로그래밍할 수 있습니다.

무전기 활성화 또는 무전기 비활성화 작업 중에  을 누르면 승인 메시지가 수신되지 않습니다.





주의:

자세한 내용은 대리점이나 시스템 관리자에게 문의하십시오.

무전기 비활성화 ●

다음 절차에 따라 무전기를 비활성화합니다.

1 프로그래밍된 무전기 비활성화 버튼을 누릅니다.

2  또는  버튼을 눌러 원하는 별칭 또는 ID로 이동합니다.

3  버튼을 눌러 선택합니다. 다음 시나리오 중 하나가 발생합니다.

- 디스플레이에 전환 미니 알림이 표시되어 요청이 진행 중임을 나타냅니다. 녹색 LED가 깜박입니다.
- 암호구 화면이 표시됩니다.

암호구를 입력합니다.  버튼을 눌러 계속합니다.

- 암호구가 올바르면 디스플레이에 전환 미니 알림이 표시되어 요청이 진행 중임을 나타냅니다. 녹색 LED가 켜집니다.
- 암호구가 틀리면 디스플레이에 해제 미니 알림이 표시되고 이전 화면으로 돌아갑니다.

4 승인을 기다립니다.

성공 시:

- 선택음이 울립니다.
- 디스플레이에 선택 미니 알림이 표시됩니다.



실패 시:



- 해제음이 울립니다.
- 디스플레이에 해제 미니 알림이 표시됩니다.



연락처 목록을 사용하여 무전기 비활성화

다음 절차에 따라 연락처 목록을 사용하여 무전기를 비활성화합니다.

- 1  버튼을 눌러 메뉴로 이동합니다.

- 2  또는  버튼을 눌러 연락처로 이동합니다.
 버튼을 눌러 선택합니다.

- 3  또는  버튼을 눌러 원하는 별칭 또는 ID로 이동합니다.  버튼을 눌러 선택합니다.

- 4  또는  버튼을 눌러 무전기 비활성화로 이동합니다.

- 5  버튼을 눌러 선택합니다. 다음 시나리오 중 하나가 발생합니다.
 - 디스플레이에 전환 미니 알림이 표시되어 요청이 진행 중임을 나타냅니다. 녹색 LED가 깜박입니다.

- 암호구 화면이 표시됩니다.
암호구를 입력합니다.  버튼을 눌러 계속합니다.
- 암호구가 올바르면 디스플레이에 전환 미니 알림이 표시되어 요청이 진행 중임을 나타냅니다. 녹색 LED가 켜집니다.
- 암호구가 틀리면 디스플레이에 해제 미니 알림이 표시되고 이전 화면으로 돌아갑니다.

6 승인을 기다립니다.

성공 시:

- 선택음이 울립니다.
- 디스플레이에 선택 미니 알림이 표시됩니다.



실패 시:



- 해제음이 울립니다.
- 디스플레이에 해제 미니 알림이 표시됩니다.



매뉴얼 다이얼을 사용하여 무전기 비활성화

다음 절차에 따라 매뉴얼 다이얼을 사용하여 무전기를 비활성화합니다.



- 1  버튼을 눌러 메뉴로 이동합니다.



- 2  또는  버튼을 눌러 연락처로 이동합니다.
 버튼을 눌러 선택합니다.

- 3  또는  버튼을 눌러 매뉴얼 다이얼로 이동합니다.  버튼을 눌러 선택합니다.

- 4  또는  버튼을 눌러 무전기 번호를 선택합니다.  버튼을 눌러 선택합니다.
첫 번째 텍스트 줄에 무전기 번호:가 표시됩니다.

- 5 가입자 ID를 입력하고  버튼을 눌러 계속합니다.

- 6  또는  버튼을 눌러 무전기 비활성화로 이동합니다.

- 7  버튼을 눌러 선택합니다. 다음 시나리오 중 하나가 발생합니다.
 - 디스플레이에 전환 미니 알림이 표시되어 요청이 진행 중임을 나타냅니다. 녹색 LED가 깜박입니다.
 - 암호구 화면이 표시됩니다.
 - 암호구를 입력합니다.  버튼을 눌러 계속합니다.
 - 암호구가 올바르면 디스플레이에 전환 미니 알림이 표시되어 요청이 진행 중임을 나타냅니다. 녹색 LED가 켜집니다.
 - 암호구가 틀리면 디스플레이에 해제 미니 알림이 표시되고 이전 화면으로 돌아갑니다.



- 8 승인을 기다립니다.
 - 성공 시:
 - 선택음이 울립니다.
 - 디스플레이에 선택 미니 알림이 표시됩니다.
 - 실패 시:

- 해제음이 울립니다.
- 디스플레이에 해제 미니 알림이 표시됩니다.

무전기 활성화

다음 절차에 따라 무전기를 활성화합니다.

1 프로그래밍된 **무전기 활성화** 버튼을 누릅니다.

2  또는  버튼을 눌러 원하는 별칭 또는 ID로 이동합니다.

3  버튼을 눌러 선택합니다. 다음 시나리오 중 하나가 발생합니다.

- 디스플레이에 무전기 활성화 및 가입자 별칭 또는 ID가 표시됩니다. 녹색 LED가 켜집니다.
- 암호구 화면이 표시됩니다.

암호구를 입력합니다.  버튼을 눌러 계속합니다.

- 암호구가 올바르면 디스플레이에 전환 미니 알림이 표시되어 요청이 진행 중임을 나타냅니다. 녹색 LED가 켜집니다.
- 암호구가 틀리면 디스플레이에 해제 미니 알림이 표시되고 이전 화면으로 돌아갑니다.

4 승인을 기다립니다.

성공 시:

- 선택음이 울립니다.
- 디스플레이에 선택 미니 알림이 표시됩니다.



실패 시:

- 해제음이 울립니다.
- 디스플레이에 해제 미니 알림이 표시됩니다.



연락처 목록을 사용하여 무전기 활성화

다음 절차에 따라 연락처 목록을 사용하여 무전기를 활성화합니다.



1  버튼을 눌러 메뉴로 이동합니다.

2  또는  버튼을 눌러 연락처로 이동합니다.

 버튼을 눌러 선택합니다.

3  또는  버튼을 눌러 원하는 별칭 또는 ID로

이동합니다.  버튼을 눌러 선택합니다.

4  또는  버튼을 눌러 무전기 활성화로 이동합니다.

5  버튼을 눌러 선택합니다. 다음 시나리오 중 하나가 발생합니다.

- 녹색 LED가 깜박입니다. 디스플레이에 무전기 활성화 및 가입자 별칭 또는 ID가 표시됩니다. 녹색 LED가 켜집니다.
- 암호구 화면이 표시됩니다.

암호구를 입력합니다.  버튼을 눌러 계속합니다.

- 암호구가 올바르면 디스플레이에 전환 미니 알림이 표시되어 요청이 진행 중임을 나타냅니다. 녹색 LED가 켜집니다.

- 암호구가 틀리면 디스플레이에 해제 미니 알림이 표시되고 이전 화면으로 돌아갑니다.

6 승인을 기다립니다.

성공 시:

- 선택음이 울립니다.
- 디스플레이에 선택 미니 알림이 표시됩니다.

실패 시:



- 해제음이 울립니다.
- 디스플레이에 해제 미니 알림이 표시됩니다.

매뉴얼 다이얼을 사용하여 무전기 활성화





다음 절차에 따라 매뉴얼 다이얼을 사용하여 무전기를 활성화합니다.



1  버튼을 눌러 메뉴로 이동합니다.

2  또는  버튼을 눌러 연락처로 이동합니다.

 버튼을 눌러 선택합니다.

3  또는  버튼을 눌러 매뉴얼 다이얼로 이동



합니다.  버튼을 눌러 선택합니다.

4  또는  을 눌러 개별 호출로 이동합니다.

 버튼을 눌러 선택합니다.

첫 번째 텍스트 줄에 무전기 번호:가 표시됩니다.

5 가입자 ID를 입력하고  버튼을 눌러 계속합니다.

6  또는  버튼을 눌러 무전기 활성화로 이동합니다.

7  버튼을 눌러 선택합니다. 다음 시나리오 중 하나가 발생합니다.

- 녹색 LED가 깜박입니다. 디스플레이에 무전기 활성화 및 가입자 별칭 또는 ID가 표시됩니다. 녹색 LED가 켜집니다.

- 암호구 화면이 표시됩니다.

암호구를 입력합니다.  버튼을 눌러 계속합니다.

- 암호구가 올바르면 디스플레이에 전환 미니 알람이 표시되어 요청이 진행 중임을 나타냅니다. 녹색 LED가 켜집니다.
 - 암호구가 틀리면 디스플레이에 해제 미니 알람이 표시되고 이전 화면으로 돌아갑니다.
-

8 승인을 기다립니다.

성공 시:

- 선택음이 울립니다.
- 디스플레이에 선택 미니 알람이 표시됩니다.

실패 시:

- 해제음이 울립니다.
 - 디스플레이에 해제 미니 알람이 표시됩니다.
-

단독 작업자

이 기능은 무전기 버튼 또는 채널 선택 스위치를 작동할 때와 같이 미리 정해진 시간 동안 사용자 활동이 없으면 비상 상태임을 알립니다.

프로그래밍된 기간 동안 사용자 활동이 없는 경우, 무전기는 비활성 타이머가 만료되는 즉시 상태 표시음을 통해 사용자에게 사전 경고를 보냅니다.

미리 정해진 알람 타이머가 만료될 때까지도 사용자가 승인하지 않으면 무전기는 비상 알람을 시작합니다.

이 기능에는 다음 비상 알람 중 하나만 지정됩니다.

- 비상 경보
- 비상 알람 및 호출
- 비상 알람 후 음성 알람 

무전기는 조치를 취할 때까지 음성 메시지가 계속되도록 비상 상태를 유지합니다. 비상 모드를 종료하는 방법에 대한 자세한 내용은 [비상 작동 페이지의 398](#) 부분을 참조하십시오.



주의:

이 기능은 이 기능이 활성화된 무전기에만 적용됩니다. 자세한 내용은 대리점이나 시스템 관리자에게 문의하십시오.

Bluetooth

이 기능을 사용하면 Bluetooth 연결을 통해 무전기를 Bluetooth 사용 장치(액세서리)와 함께 사용할 수 있습니다. 이 무전기는 Motorola Solutions 및 Commercially available Off-The-Shelf(COTS) Bluetooth 사용 장치를 모두 지원합니다.

Bluetooth는 시야 10m(32피트) 범위 내에서 작동합니다. 이 범위 내에 있어야 무전기와 Bluetooth 사용 장치 간에 장애 없이 통신이 이루어집니다. 높은 신뢰성을 위해 무전기와 액세서리를 분리하지 말 것을 권장합니다.

수신 주변 영역에서는 음성과 경보음 품질이 모두 "왜곡되거나" "끊겨서" 들리기 시작합니다. 이 문제를 해결하려면 무전기와 Bluetooth 사용 장치를 가까이(10m 내) 배치하여 깨끗한 오디오 수신을 재설정합니다. 무전기의 Bluetooth 기능은 10m 범위에서 최대 2.5mW(4dBm)로 작동합니다.

무전기는 다른 유형의 Bluetooth 사용 장치와의 Bluetooth 연결을 동시에 3개까지 지원할 수 있습니다. 헤드셋, 스캐너 및 POD(PTT-Only Device)를 예로 들 수 있습니다. 동일한 유형의 Bluetooth 장치와의 복수 연결은 지원되지 않습니다.

해당 Bluetooth 사용 장치의 전체 기능에 대한 자세한 내용은 Bluetooth 지원 장치의 사용 설명서를 참조하십시오.



**주의:**





CPS를 통해 비활성화된 경우 모든 Bluetooth 관련 기능이 비활성화되고 Bluetooth 장치 데이터베이스가 지워집니다.

블루투스 켜기 및 끄기









절차에 따라 Bluetooth를 켜고 끕니다.

- 1  버튼을 눌러 메뉴로 이동합니다.

- 2  또는  버튼을 눌러 Bluetooth로 이동합니다.  버튼을 눌러 선택합니다.

- 3  또는  을 눌러 내 상태로 이동합니다.  버튼을 눌러 선택합니다.
디스플레이에 켜기와 끄기가 표시됩니다. 현재 상태는  로 표시됩니다.

- 4 다음 중 하나를 수행합니다.



-  또는  버튼을 눌러 켜기로 이동합니다.  버튼을 눌러 선택합니다.  가 디스플레이의 켜기 옆에 표시됩니다.
-  또는  버튼을 눌러 끄기로 이동합니다.  버튼을 눌러 선택합니다.  가 디스플레이의 끄기 옆에 표시됩니다.



블루투스 장치에 연결

절차에 따라 Bluetooth 장치를 연결합니다.









블루투스 사용 장치를 켜고 페어링 모드로 설정합니다.

- 1  버튼을 눌러 메뉴로 이동합니다.

- 2  또는  버튼을 눌러 Bluetooth로 이동합니다.  버튼을 눌러 선택합니다.

- 3  또는  버튼을 눌러 장치로 이동합니다.  버튼을 눌러 선택합니다.

4 다음 중 하나를 수행합니다.

-  또는  버튼을 눌러 원하는 장치로 이동합니다.  버튼을 눌러 선택합니다.
-  또는  을 눌러 장치 찾기로 이동한 후 사용 가능한 장치를 찾습니다.  또는  버튼을 눌러 원하는 장치로 이동합니다.  버튼을 눌러 선택합니다.

5 또는 을 눌러 연결로 이동합니다. 버튼을 눌러 선택합니다.

블루투스 사용 장치에서 페어링을 완료하려면 추가 단계를 수행해야 할 수 있습니다. Bluetooth 사용 장치의 사용자 설명서를 참조하십시오.

디스플레이에 <장치>에 연결 중이 표시됩니다.

승인을 기다립니다.

성공 시:

- 선택음이 울립니다.
- 디스플레이에 <장치>에 연결됨 및 **Bluetooth 연결** 아이콘이 표시됩니다.

- 디스플레이에서 연결된 장치 옆에 가 표시됩니다.

실패 시:

- 해제음이 울립니다.
- 디스플레이에 연결 실패가 표시됩니다.









주의:

PIN 코드가 필요한 경우 **비밀번호를 사용하여 무전기에 액세스 페이지의 172** 부분을 참조하십시오.

검색 가능 모드에서 블루투스 장치에 연결

절차에 따라 검색 가능 모드에서 Bluetooth 장치를 연결합니다.

Bluetooth 사용 장치를 켜고 페어링 모드로 설정합니다.

- 1  버튼을 눌러 메뉴로 이동합니다.
- 2  또는  을 눌러 Bluetooth로 이동합니다.  버튼을 눌러 선택합니다.
- 3  또는  을 눌러 내 장치 찾기로 이동합니다.  버튼을 눌러 선택합니다. 이제 프로그래밍

하는 과정에서 다른 Bluetooth 사용 장치가 사용자의 무전기를 검색할 수 있습니다. 이를 검색 가능 모드로 합니다.

승인을 기다립니다.

성공 시:

- 선택음이 울립니다.
- 디스플레이에 <장치>에 연결됨 및 Bluetooth 연결 아이콘이 표시됩니다.
- 디스플레이에서 연결된 장치 옆에 ✓가 표시됩니다.



실패 시:



- 해제음이 울립니다.
- 디스플레이에 연결 실패가 표시됩니다.

블루투스 장치 연결 해제



절차에 따라 Bluetooth 장치의 연결을 해제합니다.

1  버튼을 눌러 메뉴로 이동합니다.



2  또는  버튼을 눌러 Bluetooth로 이동합니다.  버튼을 눌러 선택합니다.

3  또는  버튼을 눌러 장치로 이동합니다.

 버튼을 눌러 선택합니다.

4  또는  버튼을 눌러 원하는 장치로 이동합니다.

 버튼을 눌러 선택합니다.

5  또는  버튼을 눌러 연결 해제로 이동합니다.

 버튼을 눌러 선택합니다.

디스플레이에 <디바이스>에서 연결 끊는중이 표시됩니다.



주의:

Bluetooth 사용 장치에서 연결을 끊으려면 추가 단계를 수행해야 할 수 있습니다. Bluetooth 사용 장치의 모든 사용자 설명서를 참조하십시오.

승인을 기다립니다.

- 신호음이 울립니다.
- 디스플레이에 <디바이스> 연결끊김이 표시되고 Bluetooth 연결 아이콘이 사라집니다.

- 연결된 장치 옆에 있는 ✓가 사라집니다.

무전기 내부 스피커와 블루투스 장치 간에 오디오 라우팅 전환

다음 절차에 따라 무전기 내부 스피커와 외부 Bluetooth 장치 간에 오디오 라우팅을 전환할 수 있습니다.

프로그래밍된 Bluetooth 오디오 스위치 버튼을 누릅니다.



디스플레이에 다음 결과 중 하나가 표시됩니다.



- 신호음이 울립니다. 디스플레이에 무전기로 오디오 내보내기가 표시됩니다.
- 신호음이 울립니다. 디스플레이에 Bluetooth로 오디오 내보내기가 표시됩니다.



장치 세부 항목 보기



다음 절차에 따라 무전기에서 장치 세부 정보를 확인합니다.

-  버튼을 눌러 메뉴로 이동합니다.

-  또는  버튼을 눌러 Bluetooth로 이동합니다.  버튼을 눌러 선택합니다.

-  또는  버튼을 눌러 장치로 이동합니다.  버튼을 눌러 선택합니다.



-  또는  버튼을 눌러 원하는 장치로 이동합니다.  버튼을 눌러 선택합니다.



-  또는  버튼을 눌러 세부 항목 보기로 이동합니다.  버튼을 눌러 선택합니다.



장치 이름 삭제



분리된 장치를 블루투스 사용 장치 목록에서 제거할 수 있습니다.



-  버튼을 눌러 메뉴로 이동합니다.



2  또는  버튼을 눌러 Bluetooth로 이동합니다.  버튼을 눌러 선택합니다.



3  또는  버튼을 눌러 장치로 이동합니다.  버튼을 눌러 선택합니다.



4  또는  버튼을 눌러 원하는 장치로 이동합니다.  버튼을 눌러 선택합니다.

5  또는  버튼을 눌러 삭제로 이동합니다.  버튼을 눌러 선택합니다. 디스플레이에 장치 삭제 완료가 표시됩니다.

2  또는  버튼을 눌러 Bluetooth로 이동합니다.  버튼을 눌러 선택합니다.

3  또는  버튼을 눌러 Bluetooth 마이크 개인으로 이동합니다.  버튼을 눌러 선택합니다.

4  또는  버튼을 눌러 Bluetooth 마이크 개인 유형 및 현재 값으로 이동합니다.  버튼을 눌러 선택합니다. 여기에서 값을 편집할 수 있습니다.

5  또는  버튼을 눌러 값을 늘이거나 줄입니다.  버튼을 눌러 선택합니다.

Bluetooth 마이크 개인

이 기능을 사용하여 연결된 Bluetooth 사용 장치의 마이크 개인 값을 제어할 수 있습니다.

1  버튼을 눌러 메뉴로 이동합니다.

실내 위치



주의:









실내 위치 기능은 최신 소프트웨어 및 하드웨어와 모델에만 적용됩니다. 자세한 내용은 대리점이나 시스템 관리자에게 문의하십시오.

실내 위치는 무전기 사용자의 위치를 추적하는 데 사용됩니다. 실내 위치가 활성화되면 무전기가 제한된 검색 가능 모

드가 됩니다. 무전기를 찾아 해당 위치를 확인할 전용 비콘이 사용됩니다.

실내 위치 켜기 또는 끄기

다음 작업 중 하나를 수행하여 실내 위치를 켜거나 끌 수 있습니다.

- 메뉴를 통해 이 기능에 액세스합니다.
 - a.  버튼을 눌러 메뉴에 액세스합니다. 버튼을 누릅니다.
 - b.  또는  을 눌러 Bluetooth 및 선택하려는  버튼을 누릅니다.로 이동합니다.
 - c.  또는  을 눌러 실내 위치 및 선택하려는  버튼을 누릅니다.로 이동합니다.
 - d.  을 눌러 실내 위치를 켵니다.
디스플레이에 실내 위치 켜기가 표시됩니다. 선택음이 들립니다.
다음 시나리오 중 하나가 발생합니다.
 - 성공할 경우, 홈 화면 디스플레이에 실내 위치 사용 가능 아이콘이 나타납니다.

- 실패하는 경우, 디스플레이에 켜기 실패가 표시됩니다. 해제음이 들립니다.

- e.  을 눌러 실내 위치를 끍니다.

디스플레이에 실내 위치 끄기가 표시됩니다. 선택음이 들립니다.

다음 시나리오 중 하나가 발생합니다.

- 성공할 경우, 홈 화면 디스플레이에서 실내 위치 사용 가능 아이콘이 사라집니다.
- 실패하는 경우, 디스플레이에 끄기 실패가 표시됩니다. 해제음이 들립니다.

- 프로그래밍된 버튼을 사용하여 이 기능에 액세스합니다.

- a. 프로그래밍된 **실내 위치** 버튼을 길게 눌러 실내 위치를 켵니다.

디스플레이에 실내 위치 켜기가 표시됩니다. 선택음이 들립니다.





다음 시나리오 중 하나가 발생합니다.



- 성공할 경우, 홈 화면 디스플레이에 실내 위치 사용 가능 아이콘이 나타납니다.



- 실패하는 경우, 디스플레이에 켜기 실패가 표시됩니다. 실패하는 경우, 해제음이 들립니다.
- b. 프로그래밍된 **실내 위치** 버튼을 눌러 실내 위치를 끕니다.
- 디스플레이에 실내 위치 끄기가 표시됩니다. 선택음이 들립니다.
- 다음 시나리오 중 하나가 발생합니다.
- 성공할 경우, 홈 화면 디스플레이에서 실내 위치 사용 가능 아이콘이 사라집니다.
 - 실패하는 경우, 디스플레이에 끄기 실패가 표시됩니다. 실패하는 경우, 해제음이 들립니다.

실내 위치 비콘 정보에 액세스

다음 절차에 따라 실내 위치 비콘 정보에 액세스합니다.

- 1  버튼을 눌러 메뉴에 액세스합니다.를 누릅니다.
-
- 2  또는  을 눌러 Bluetooth 및 선택하려면  버튼을 누릅니다.로 이동합니다.
-

- 3  또는  을 눌러 실내 위치 및 선택하려면  버튼을 누릅니다.로 이동합니다.
-

- 4  또는  을 눌러 비콘 및 선택하려면  버튼을 누릅니다.로 이동합니다.
-

디스플레이에 비콘 정보가 표시됩니다.

알림 목록

무전기에는 채널에서 읽지 않은 문자 메시지, 텔리메트리 메시지, 부재중 수신통화, 호출 경보 등의 읽지 않은 모든 이벤트를 수집하는 알림 목록이 있습니다.

알림 목록에 하나 이상의 이벤트가 있는 경우 디스플레이에 **알림** 아이콘이 표시됩니다.



목록은 최대 40개의 읽지 않은 이벤트를 지원하며 목록이 가득 차면 다음 이벤트가 가장 오래된 이벤트를 자동으로 대체합니다. 읽은 이벤트는 알림 목록에서 제거됩니다.





문자 메시지, 부재 중 호출, 호출 경보 이벤트의 경우 알림의 최대 수는 문자 메시지 30개와 부재 중 호출 또는 호출 경보 10개입니다. 이 최대 수는 개별 기능(작업 티켓이나 문자 메시지 또는 부재중 호출/호출 경보)의 목록 기능에 따라 달라집니다.

알림 목록에 액세스

다음 절차에 따라 무전기에서 알림 목록에 액세스합니다.

- 1  버튼을 눌러 메뉴로 이동합니다.

- 2  또는  버튼을 눌러 알림으로 이동합니다.
 버튼을 눌러 선택합니다.

- 3  또는  버튼을 눌러 원하는 이벤트로 이동합니다.  버튼을 눌러 선택합니다.
홈 화면으로 돌아가려면  버튼을 길게 누릅니다.

ARTS

ARTS(Auto-Range Transponder System)는 해당 무전기가 ARTS가 구성된 다른 무전기의 통화권 범위를 이탈했을 때 사용자에게 이를 알려주는 아날로그 전용 기능입니다.

ARTS가 구성된 무전기는 주기적으로 신호를 송신 또는 수신함으로써 무전기가 상호 간에 통화권 범위 내에 있는지 확인합니다.

무전기에 표시되는 상태 표시는 다음과 같습니다.

최초 정보

신호음이 울립니다.

디스플레이에 채널 별칭 다음에 통화권 내가 표시됩니다.

ARTS 통화권 내 정보

신호음이 울립니다.(프로그래밍된 경우).

디스플레이에 채널 별칭 다음에 통화권 내가 표시됩니다.

ARTS 통화권을 벗어남 정보

신호음이 울립니다. 빨간색 LED가 빠르게 깜박입니다.

디스플레이에 통화권 이탈과 홈 화면이 교대로 표시됩니다.



주의:

자세한 내용은 대리점이나 시스템 관리자에게 문의하십시오.

OTAP(무선 프로그래밍)

물리적으로 연결하지 않아도 OTAP(무선 프로그래밍)를 통해 대리점에서 무전기를 원격으로 업데이트할 수 있습니다. 또한 OTAP를 통해 일부 설정을 구성할 수도 있습니다.

무전기에서 OTAP가 진행 중일 경우 녹색 LED가 깜박입니다.

무전기에서 대용량 데이터를 수신 중이면:

- 디스플레이에 **대용량 데이터** 아이콘이 표시됩니다.
- 채널이 사용 중 모드가 됩니다.
- **PTT** 버튼을 누르면 실패음이 울립니다.

구성에 따라 OTAP가 완료되면:

- 신호음이 울립니다. 디스플레이에 업데이트 재시작 중이 표시됩니다. 전원이 꺼졌다 다시 켜지며 무전기가 다시 시작됩니다.
- 지금 재시작 또는 연기를 선택할 수 있습니다. 지연을 선택하면 무전기가 이전 화면으로 돌아갑니다. 자동으로 재시작되기 전까지 디스플레이에 **OTAP 지연 타이머** 아이콘이 표시됩니다.

자동 재시작 후 무전기 전원이 켜지면:

- 성공한 경우 디스플레이에 소프트웨어 업데이트 완료가 표시됩니다.
- 실패한 경우 디스플레이에 소프트웨어 업데이트 실패가 표시됩니다.

업데이트된 소프트웨어 버전에 대해서는 [소프트웨어 업데이트 정보 확인 페이지의 207](#) 부분을 참조하십시오.

송신 금지

사용자는 송신 금지 기능으로 무전기의 모든 전송을 차단할 수 있습니다.





주의:

송신 금지 모드에서 블루투스 및 Wi-Fi 기능을 사용할 수 있습니다.

송신 금지 활성화

다음 절차에 따라 송신 금지를 활성화합니다.

다음 작업 중 하나를 수행합니다.

-  또는  을 눌러 전송 금지 및 선택하려면  버튼을 누릅니다.로 이동합니다.
- **송신 금지** 프로그래밍 가능 버튼을 누릅니다.

- 선택음이 울립니다.
- 디스플레이에 전송 금지 켜기가 표시됩니다.



주의:

송신 금지 상태는 무전기 전원을 켜 후에도 변경되지 않습니다.

송신 금지 비활성화

다음 절차에 따라 송신 금지를 비활성화합니다.

다음 작업 중 하나를 수행합니다.

- ▲ 또는 ▼ 을 눌러 전송 금지 및 선택하려면  버튼을 누릅니다.로 이동합니다.
 - 송신 금지 프로그래밍 가능 버튼을 누릅니다.
-
- 해제음이 울립니다. 송신이 정상 작동으로 돌아옵니다.
 - 디스플레이에 전송 금지 끄기가 표시됩니다.

타사 주변 기기 연결 모드 선택

다음 절차에 따라 다음과 같은 타사 주변 기기 연결 모드 중 하나를 선택합니다.

- Motorola Solutions
- PC 및 오디오
- 데이터 액세스리
- 텔레메트리

• 일반

-  버튼을 눌러 메뉴로 이동합니다.

 - ▲ 또는 ▼ 버튼을 눌러 유틸리티로 이동합니다.  버튼을 눌러 선택합니다.

 - ▲ 또는 ▼ 버튼을 눌러 무전기 설정으로 이동합니다.  버튼을 눌러 선택합니다.

 - ▲ 또는 ▼ 버튼을 눌러 케이블 타입으로 이동합니다.  버튼을 눌러 선택합니다.

 - ▲ 또는 ▼ 버튼을 눌러 원하는 연결 모드로 이동합니다.  버튼을 눌러 선택합니다.
 디스플레이에 선택된 연결 모드가 나타납니다. 화면이 이전 메뉴로 돌아갑니다.
-

수신 신호 강도 표시기

이 기능을 사용하여 RSSI(Received Signal Strength Indicator, 수신 신호 강도 표시기) 값을 확인할 수 있습니다.

디스플레이 오른쪽 상단에 **RSSI** 아이콘이 표시됩니다.

RSSI 아이콘에 대한 자세한 내용은 **디스플레이 아이콘** 부분을 참조하십시오.

RSSI 값 보기

4방향 탐색 키패드 마이크(Motorola Solutions 부품 번호: RMN5127_)를 무전기에 장착합니다.

홈 화면에서 4방향 탐색 키패드를 사용해 ◀ 버튼을 세 번 누르고 즉시 ▶ 버튼을 세 번 누릅니다.

디스플레이에 현재 RSSI 값이 표시됩니다.

홈 화면으로 돌아가려면 (↶) 버튼을 길게 누릅니다.

비밀번호 잠금 기능

이 기능을 사용하면 장치를 켜올 때 암호를 물어 무전기 액세스 권한을 제한할 수 있습니다.

키패드 마이크 또는 위로 스크롤/아래로 스크롤 버튼을 사용하여 암호를 입력할 수 있습니다.

비밀번호를 사용하여 무전기에 액세스

다음 절차에 따라 암호를 사용하여 무전기에 액세스합니다.

- 1 현재 4자리 비밀번호를 입력합니다.



주의:

비상 쏫 스위치를 사용하면 무전기에 액세스하기 위한 암호 입력이 취소됩니다.

- 키패드 마이크를 사용합니다.
- ▲ 또는 ▼ 버튼을 눌러 각 자리의 숫자 값을 편집한 다음 (OK) 버튼을 눌러 입력하고 다음 자리로 이동합니다.

- 2 (OK) 버튼을 눌러 비밀번호를 입력합니다.

성공하면 무전기 전원이 켜집니다.

실패 시:

- 첫 번째 및 두 번째 시도가 실패하면 디스플레이에 암호 불일치가 표시됩니다. 단계 1 단계를 반복합니다.

- 세 번째 시도가 실패하면 디스플레이에 암호 불일치가 표시된 다음 무전기 잠금이 표시됩니다. 신호음이 울립니다. 노란색 LED가 2회 깜박입니다. 무전기가 15분 동안 잠금 상태가 됩니다.



주의:

잠긴 상태에서 무전기는 **켜기/끄기/볼륨 조절 노브** 및 프로그래밍된 **백라이트** 버튼 입력에만 응답합니다.

잠금 상태에서 무전기 잠금 해제

잠금 상태에서는 무전기가 호출을 수신할 수 없습니다. 다음 절차에 따라 잠금 상태에서 무전기 잠금을 해제합니다.











다음 중 하나를 수행합니다.

- 무전기 전원이 켜져 있으면 15분 동안 기다린 다음 **비밀번호를 사용하여 무전기에 액세스 페이지의 172**의 단계를 반복하여 무전기에 액세스합니다.
- 무전기 전원이 꺼지면 무전기 전원을 켭니다. 잠금 상태 시 15분 타이머가 다시 시작됩니다. 신호음이 울립니다. 노란색 LED가 2회 깜박입니다. 디스플레이에 무전기 잠금이 표시됩니다.

15분 동안 기다린 다음 **비밀번호를 사용하여 무전기에 액세스 페이지의 172**의 단계를 반복하여 무전기에 액세스합니다.

비밀번호 잠금 켜기 또는 끄기

다음 절차에 따라 무전기에서 비밀번호 잠금을 켜거나 끕니다.

-  버튼을 눌러 메뉴로 이동합니다.
-  또는  버튼을 눌러 유틸리티로 이동합니다.  버튼을 눌러 선택합니다.
-  또는  버튼을 눌러 무전기 설정으로 이동합니다.  버튼을 눌러 선택합니다.
-  또는  버튼을 눌러 암호 잠금으로 이동합니다.  버튼을 눌러 선택합니다.
- 현재 4자리 비밀번호를 입력합니다.
 - 키패드 마이크를 사용합니다.

- ▲ 또는 ▼ 버튼을 눌러 각 자리의 숫자 값을 편집할 다음 OK 버튼을 눌러 입력하고 다음 자리로 이동합니다.
각 자리를 누를 때마다 선택음이 울립니다.

6 OK 버튼을 눌러 비밀번호를 입력합니다.
비밀번호가 틀리면 디스플레이에 비밀번호 불일치가 표시되고 자동으로 이전 메뉴로 돌아갑니다.

7 다음 중 하나를 수행합니다.

- ▲ 또는 ▼ 버튼을 눌러 켜기로 이동합니다.
OK 버튼을 눌러 선택합니다.
✓가 디스플레이의 켜기 옆에 표시됩니다.
- ▲ 또는 ▼ 버튼을 눌러 끄기로 이동합니다.
OK 버튼을 눌러 선택합니다.
✓가 디스플레이의 끄기 옆에 표시됩니다.

비밀번호 변경

다음 절차에 따라 무전기에서 암호를 변경합니다.

1 OK 버튼을 눌러 메뉴로 이동합니다.

2 ▲ 또는 ▼ 버튼을 눌러 유틸리티로 이동합니다.
OK 버튼을 눌러 선택합니다.

3 ▲ 또는 ▼ 버튼을 눌러 무전기 설정으로 이동합니다.
OK 버튼을 눌러 선택합니다.

4 ▲ 또는 ▼ 버튼을 눌러 암호 잠금으로 이동합니다.
OK 버튼을 눌러 선택합니다.

5 현재 4자리 암호를 입력하고 OK 버튼을 눌러 계속합니다.
비밀번호가 틀리면 디스플레이에 비밀번호 불일치가 표시되고 자동으로 이전 메뉴로 돌아갑니다.

6 ▲ 또는 ▼ 버튼을 눌러 암호 변경으로 이동합니다.
OK 버튼을 눌러 선택합니다.

7 4자리 새 암호를 입력하고  버튼을 눌러 계속합니다.

8 4자리 새 암호를 다시 입력하고  버튼을 눌러 계속합니다.



성공한 경우 디스플레이에 암호 변경 완료가 표시됩니다.



실패한 경우 디스플레이에 암호 일치하지 않음이 표시됩니다.

화면이 자동으로 이전 메뉴로 돌아갑니다.

홈 화면으로 돌아가려면 언제든지  버튼을 길게 누릅니다.

1  버튼을 눌러 메뉴로 이동합니다.

2  또는  버튼을 눌러 유틸리티로 이동합니다.  버튼을 눌러 선택합니다.

3  또는  버튼을 눌러 무전기 프로그래밍으로 이동합니다.  버튼을 눌러 선택합니다.

전면 패널 구성





무전기의 편리한 사용을 위해 전면 패널 구성(FPC)의 특정 기능 매개 변수를 사용자 정의할 수 있습니다.

전면 패널 구성 모드 들어가기

다음 절차에 따라 무전기에서 전면 패널 프로그래밍 모드에 들어갑니다.

FPP 모드 매개변수 편집

기능 매개 변수를 탐색하는 동안 필요할 때 다음 버튼을 사용합니다.

-   , - 옵션을 스크롤하거나, 값을 증가/감소시키거나, 세로로 탐색합니다.
-  - 옵션을 선택하거나 하위 메뉴로 진입합니다.
-  - 짧게 눌러 이전 메뉴로 돌아가거나 선택 화면을 종료합니다. 홈 화면으로 돌아가려면 길게 누릅니다.

Wi-Fi 작동

이 기능을 통해서 Wi-Fi 네트워크를 설정하고 연결할 수 있습니다. Wi-Fi는 무선 펌웨어, 코드플러그 및 언어 팩 및 음성 안내와 같은 리소스에 대한 업데이트를 지원합니다.



주의:

이 기능은 XiR M8668i/CM7668i에만 적용됩니다.

Wi-Fi®는 Wi-Fi Alliance®의 등록 상표입니다.

본 무전기는 WEP/WPA/WPA2 개인용 및 WPA/WPA2 기업용 Wi-Fi 네트워크를 지원합니다.

WEP/WPA/WPA2 개인용 Wi-Fi 네트워크

사전 공유 키(암호) 기반 인증을 사용합니다.

사전 공유 키는 메뉴 또는 CPS/RM을 사용하여 입력할 수 있습니다.

WPA/WPA2 기업용 Wi-Fi 네트워크

인증서 기반 인증을 사용합니다.

무전기에는 인증서가 미리 구성되어 있어야 합니다.



주의:

WPA/WPA2 기업용 Wi-Fi 네트워크에 연결하려면 판매점 또는 시스템 관리자에게 문의하십시오.

대리점이나 시스템 관리자가 프로그래밍된 **Wi-Fi 켜기 또는 끄기** 버튼이 할당합니다. 무전기가 프로그래밍된 방식에 대해서는 대리점이나 시스템 관리자에게 문의하십시오.

프로그래밍된 **Wi-Fi 켜기 또는 끄기** 버튼에 대한 음성 안내는 사용자의 요구 사항에 따라 CPS를 통해 맞춤 설정할 수 있습니다. 자세한 내용은 대리점이나 시스템 관리자에게 문의하십시오.







주의:



감독자 무선 시스템을 사용하여 Wi-Fi를 원격으로 켜거나 끌 수 있습니다(**감독 기능 무전기를 사용하여 Wi-Fi 켜기 또는 끄기** 참조). 자세한 내용은 대리점이나 시스템 관리자에게 문의하십시오.

Wi-Fi 켜기 또는 끄기

절차에 따라 Wi-Fi를 켜고 끕니다.

- 1 프로그래밍된 **Wi-Fi 켜기 또는 끄기** 버튼을 누릅니다. Wi-Fi 켜기 또는 Wi-Fi 끄기라는 음성 안내가 들립니다.



- 2 메뉴를 사용하여 이 기능에 액세스합니다.
 - a  버튼을 눌러 메뉴에 액세스합니다. 버튼을 누릅니다.
 - b  또는  를 눌러 WiFi 및 선택하려면  버튼을 누릅니다.로 이동합니다.

c  또는  를 눌러 WiFi 켜기 및 선택하려면  버튼을 누릅니다.로 이동합니다.

d  을 눌러 Wi-Fi를 켜거나 끕니다.

Wi-Fi가 켜지면 디스플레이에 가 활성화됨 옆에 표시됩니다.

Wi-Fi가 꺼지면 디스플레이에 가 활성화됨 옆에서 사라집니다.

- 프로그래밍 가능 버튼을 길게 누릅니다. 키패드를 사용하여 ID와 선택하려면  버튼을 누릅니다.을 입력합니다. 단계 3로 진행합니다.
-  버튼을 눌러 메뉴에 액세스합니다. 버튼을 누릅니다.

지정된 무전기를 사용하여 원격으로 Wi-Fi 켜기 또는 끄기(개별 제어)



다음 절차에 따라 개별 제어(일대일)에서 원격으로 Wi-Fi를 켜고 끕니다.







주의:

특정 CPS 설정이 있는 무전기만 이 기능을 지원합니다. 자세한 내용은 대리점이나 시스템 관리자에게 문의하십시오.

1 다음 중 하나를 수행합니다.

2  또는  버튼을 눌러 연락처 및 선택하려면  버튼을 누릅니다.로 이동합니다.

3  또는  버튼을 눌러 WiFi 제어로 이동한 다음  버튼을 눌러 선택합니다.

4  또는  버튼을 눌러 켜기 또는 끄기를 선택합니다.

5  버튼을 눌러 선택합니다.

성공한 경우 디스플레이에 선택 미니 알림이 표시됩니다.

실패한 경우 디스플레이에 해제 미니 알림이 표시됩니다.

지정된 무전기를 사용하여 원격으로 Wi-Fi 켜기 또는 끄기(그룹 제어)



절차에 따라 그룹 제어(일대다)에서 원격으로 Wi-Fi를 켜고 끕니다.







주의:



특정 CPS 설정이 있는 무전기만이 이 기능을 지원합니다. 자세한 내용은 대리점이나 시스템 관리자에게 문의하십시오.

- 1  버튼을 눌러 메뉴에 액세스합니다. 버튼을 누릅니다.

- 2  또는  버튼을 눌러 연락처 및 선택하려면  버튼을 누릅니다.로 이동합니다.

- 3  또는  버튼을 눌러 원하는 가입자 별칭 또는 ID를 선택합니다.

- 4  또는  버튼을 눌러 WiFi 제어로 이동한 다음  버튼을 눌러 선택합니다.

- 5  또는  버튼을 눌러 켜기 또는 끄기를 선택합니다.

- 6  버튼을 눌러 선택합니다.

성공한 경우 디스플레이에 전송 성공이 표시됩니다.

실패한 경우 디스플레이에 해제 미니 알림이 표시됩니다.

네트워크 액세스 포인트에 연결

Wi-Fi를 켜면 무전기가 네트워크 액세스 포인트를 스캔하여 연결합니다.









주의:



메뉴를 통해서도 네트워크 액세스 포인트에 연결할 수 있습니다.

WPA 기업용 Wi-Fi 네트워크 액세스 포인트는 사전 구성되어 있습니다. 무전기가 프로그래밍된 방식에 대해서는 대리점이나 시스템 관리자에게 문의하십시오.

- 1  버튼을 눌러 메뉴에 액세스합니다. 버튼을 누릅니다.

2  또는  를 눌러 WiFi 및 선택하려면  버튼을 누릅니다.로 이동합니다.



3  또는  을 눌러 네트워크 및 선택하려면  버튼을 누릅니다.로 이동합니다.

4  또는  을 눌러 네트워크 액세스 포인트 및 선택하려면  버튼을 누릅니다.로 이동합니다.



주의:

WPA 기업용 Wi-Fi의 경우 네트워크 액세스 포인트가 사전 구성되어 있지 않으면 연결 옵션을 사용할 수 없습니다.

5  또는  을 눌러 연결 및 선택하려면  버튼을 누릅니다.로 이동합니다.

6 WPA 개인용 Wi-Fi의 경우 암호를 입력하고  버튼을 누릅니다.

7 WPA 기업용 Wi-Fi의 경우 RM을 사용하여 암호를 구성합니다.

사전 구성된 암호가 맞으면 선택한 네트워크 액세스 포인트에 무전기가 자동으로 연결됩니다.

사전 구성된 암호가 틀리면 디스플레이에 인증 실패가 표시되고 자동으로 이전 메뉴로 돌아갑니다.

연결에 성공하면 무전기에 알림이 표시되며 네트워크 액세스 포인트가 프로필 목록에 저장됩니다.

연결에 실패하면 무전기 디스플레이에 실패 알림이 잠깐 동안 표시되고 자동으로 이전 메뉴로 돌아갑니다.

Wi-Fi 연결 상태 확인

다음 절차에 따라 Wi-Fi 연결 상태를 확인합니다.

음성 안내를 통해 연결 상태에 대한 프로그래밍된 **Wi-Fi 상태 쿼리** 버튼을 누릅니다. Wi-Fi 꺼짐, Wi-Fi가 켜졌지만 연결 없음 또는 Wi-Fi가 켜지고 연결됨이라는 음성 안내가 들립니다.

- Wi-Fi가 꺼지면 디스플레이에 **wifi 끄기**가 표시됩니다.
- 무전기가 네트워크에 연결되면 디스플레이에 **wifi 켜기**, 연결됨이 표시됩니다.

- Wi-Fi가 켜졌지만 무전기가 네트워크에 연결되지 않은 경우 Wi-Fi 켜기, 연결 끊어짐이 표시됩니다.

Wi-Fi 상태 쿼리 결과에 대한 음성 안내는 사용자의 요구 사항에 따라 CPS를 통해 맞춤 설정할 수 있습니다. 자세한 내용은 대리점이나 시스템 관리자에게 문의하십시오.



주의:

프로그래밍된 **Wi-Fi 상태 쿼리** 버튼은 대리점이나 시스템 관리자에 의해 지정됩니다. 무전기가 프로그래밍된 방식에 대해서는 대리점이나 시스템 관리자에게 문의하십시오.

네트워크 목록 새로 고침

다음 절차에 따라 네트워크 목록을 새로 고칩니다.

- 메뉴를 통해 네트워크 목록을 새로 고치려면 다음 작업을 수행합니다.
 - a. 버튼을 눌러 메뉴에 액세스합니다. 버튼을 누릅니다.
 - b. 또는 를 눌러 Wi-Fi 및 선택하려면 버튼을 누릅니다.로 이동합니다.

- c. 또는 을 눌러 네트워크 및 선택하려면

버튼을 누릅니다.로 이동합니다.

네트워크 메뉴를 입력하면 무전기에서 자동으로 네트워크 목록을 새로 고칩니다.

- 네트워크 메뉴에 이미 있는 경우, 다음 작업을 수행하여 네트워크 목록을 새로 고침할 수 있습니다.

또는 버튼을 눌러 새로 고침으로 이동하

고 선택하려면 버튼을 누릅니다..

무전기에서 새로 고침한 뒤 최신 네트워크 목록을 표시합니다.

네트워크 추가









주의:



이 작업은 WPA 기업용 Wi-Fi 네트워크에는 적용되지 않습니다.

기본 설정 네트워크가 사용 가능한 네트워크 목록에 없는 경우 다음 작업을 수행하여 네트워크를 추가할 수 있습니다.



- 1 버튼을 눌러 메뉴에 액세스합니다.를 누릅니다.

2  또는  를 눌러 WiFi 및 선택하려면  버튼을 누릅니다.로 이동합니다.

3  또는  을 눌러 네트워크 및 선택하려면  버튼을 누릅니다.로 이동합니다.

4  또는  버튼을 눌러 네트워크 추가로 이동하고 선택하려면  버튼을 누릅니다..

5 SSID(Service Set Identifier)를 입력하고  을 누릅니다.



6  또는  버튼을 눌러 열기로 이동하고 선택하려면  버튼을 누릅니다..



7 암호를 입력하고  을 누릅니다.
무전기에 선택 미니 알림이 표시되어 네트워크가 성공적으로 저장되었음을 나타냅니다.



네트워크 액세스 포인트의 세부 항목 보기



네트워크 액세스 포인트의 세부 정보를 볼 수 있습니다.

1  버튼을 눌러 메뉴에 액세스합니다.를 누릅니다.

2  또는  를 눌러 WiFi 및 선택하려면  버튼을 누릅니다.로 이동합니다.

3  또는  을 눌러 네트워크 및 선택하려면  버튼을 누릅니다.로 이동합니다.

4  또는  을 눌러 네트워크 액세스 포인트 및 선택하려면  버튼을 누릅니다.로 이동합니다.

5  또는  버튼을 눌러 세부 항목 보기로 이동하고 선택하려면  버튼을 누릅니다..



주의:

WPA 개인용 Wi-Fi 및 WPA 기업용 Wi-Fi는 네트워크 액세스 포인트에 대한 서로 다른 세부 정보를 표시합니다.

WPA 개인용 Wi-Fi

연결된 네트워크 액세스 포인트의 경우 무전기에 SSID(Service Set Identifier), 보안 모드, MAC(media Access Control) 주소 및 IP(Internet Protocol) 주소가 표시됩니다.

연결되지 않은 네트워크 액세스 포인트의 경우 무전기에 SSID 및 보안 모드가 표시됩니다.



WPA 기업용 Wi-Fi



연결된 네트워크 액세스 포인트의 경우 무전기에 SSID, 보안 모드, ID, EAP(Extended Authentication Protocol) 방식, 2단계 인증, 인증서 이름, MAC 주소, IP 주소, 게이트웨이, DNS1 및 DNS2가 표시됩니다.



연결되지 않은 네트워크 액세스 포인트의 경우 무전기에 SSID, 보안 모드, ID, EAP 방식, 2단계 인증 및 인증서 이름이 표시됩니다.



프로파일 목록에서 네트워크 액세스 포인트를 제거하려면 다음 작업을 수행합니다.

- 1  버튼을 눌러 메뉴에 액세스합니다. 버튼을 누릅니다.

- 2  또는  를 눌러 WiFi 및 선택하려면  버튼을 누릅니다.로 이동합니다.

- 3  또는  을 눌러 네트워크 및 선택하려면  버튼을 누릅니다.로 이동합니다.



- 4  또는  버튼을 눌러 선택한 네트워크 액세스 지점으로 이동하고 선택하려면  버튼을 누릅니다..

- 5  또는  버튼을 눌러 제거로 이동하고 선택하려면  버튼을 누릅니다..

네트워크 액세스 포인트 제거

주의:

이 작업은 기업 Wi-Fi 네트워크에는 적용되지 않습니다.

6  또는  버튼을 눌러 예로 이동하고 선택하려면  버튼을 누릅니다..

무전기에 선택 미니 알림이 표시되어 선택한 네트워크 액세스 포인트가 성공적으로 제거되었음을 나타냅니다.

공공설비

이 장에서는 무전기에서 사용할 수 있는 유틸리티 기능의 작동에 대해 설명합니다.

스켈치 레벨

스켈치 레벨을 조정하여 일반적인 배경 잡음보다 더 높은 채널이나 신호 강도가 약한 원하지 않는 호출을 걸러낼 수 있습니다.

보통

기본 설정입니다.

타이트

이 설정은 원치 않는 호출 및/또는 배경 잡음을 걸러냅니다. 원격 위치에서 온 호출도 걸러질 수 있습니다.







주의:



이 기능은 동일한 주파수에 있는 Citizens 대역 채널에는 적용되지 않습니다.



스켈치 레벨 설정

다음 절차에 따라 무전기에서 스켈치 레벨을 설정합니다.







- 1 다음 중 하나를 수행합니다.
 - 프로그래밍된 **스켈치** 버튼을 누릅니다. 다음 단계를 건너뛴니다.
 -  버튼을 눌러 메뉴로 이동합니다.

- 2  또는  버튼을 눌러 유틸리티로 이동합니다.  버튼을 눌러 선택합니다.

- 3  또는  버튼을 눌러 무전기 설정으로 이동합니다.  버튼을 눌러 선택합니다.

- 4  또는  버튼을 눌러 스켈치로 이동합니다.  버튼을 눌러 선택합니다.

5 다음 중 하나를 수행합니다.

-  또는  버튼을 눌러 평상으로 이동합니다.  버튼을 눌러 선택합니다.
 ✓가 디스플레이의 평상 옆에 표시됩니다.
-  또는  버튼을 눌러 타이트로 이동합니다.  버튼을 눌러 선택합니다.
 ✓가 디스플레이의 타이트 옆에 표시됩니다.
 화면이 자동으로 이전 메뉴로 돌아갑니다.

전력 레벨

전력 레벨을 각 채널에 대해 높음 또는 낮음으로 사용자 정의할 수 있습니다.

고

높음을 사용하면 원거리에 있는 무전기와 통신할 수 있습니다.

저

낮음을 사용하면 근거리에 있는 무전기와 통신할 수 있습니다.



주의:

이 기능은 동일한 주파수에 있는 Citizens 대역 채널에는 적용되지 않습니다.



전력 레벨 설정

다음 절차에 따라 무전기에서 전력 레벨을 설정합니다.



1 다음 중 하나를 수행합니다.

- 프로그래밍된 **전력 레벨** 버튼을 누릅니다. 아래 단계를 건너뛴니다.
-  버튼을 눌러 메뉴로 이동합니다.



2

-  또는  버튼을 눌러 유틸리티로 이동합니다.  버튼을 눌러 선택합니다.







3

-  또는  버튼을 눌러 무전기 설정으로 이동합니다.  버튼을 눌러 선택합니다.

4

-  또는  버튼을 눌러 전력으로 이동합니다.  버튼을 눌러 선택합니다.

5 다음 중 하나를 수행합니다.

-  또는  버튼을 눌러 높음으로 이동합니다.  버튼을 눌러 선택합니다.
✓가 디스플레이의 높음 옆에 표시됩니다.
-  또는  버튼을 눌러 낮음으로 이동합니다.  버튼을 눌러 선택합니다.
✓가 디스플레이의 낮음 옆에 표시됩니다.

6 홈 화면으로 돌아가려면  버튼을 길게 누릅니다.



무전기 신호음/경보 켜기 또는 끄기



필요한 경우 들어오는 비상 경보음을 제외한 모든 무전기 신호음과 경보를 활성화하거나 비활성화할 수 있습니다. 다음 절차에 따라 무전기에서 신호음 및 경보를 켜거나 끕니다.



1 다음 중 하나를 수행합니다.



- 프로그래밍된 **신호음/경보** 버튼을 누릅니다. 다음 단계를 건너뛸니다.

-  버튼을 눌러 메뉴로 이동합니다.

2  또는  버튼을 눌러 유틸리티로 이동합니다.  버튼을 눌러 선택합니다.

3  또는  버튼을 눌러 무전기 설정으로 이동합니다.  버튼을 눌러 선택합니다.

4  또는  버튼을 눌러 톤/경보로 이동합니다.  버튼을 눌러 선택합니다.

5  또는  버튼을 눌러 전체 톤으로 이동합니다.  버튼을 눌러 선택합니다.



6  버튼을 눌러 전체 톤 및 경보를 활성화하거나 비활성화합니다. 디스플레이에 다음 결과 중 하나가 표시됩니다.



- 활성화되면 ✓아이콘이 활성화 옆에 표시됩니다.
- 비활성화되면 ✓아이콘이 활성화 옆에서 사라집니다.



키패드 톤 켜기 또는 끄기



다음 절차에 따라 무전기에서 키패드 톤을 켜거나 끕니다.

- 1  버튼을 눌러 메뉴로 이동합니다.



- 2  또는  버튼을 눌러 유틸리티로 이동합니다.  버튼을 눌러 선택합니다.

- 3  또는  버튼을 눌러 무전기 설정으로 이동합니다.  버튼을 눌러 선택합니다.

- 4  또는  버튼을 눌러 톤/경보로 이동합니다.  버튼을 눌러 선택합니다.

- 5  또는  버튼을 눌러 키패드 톤으로 이동합니다.  버튼을 눌러 선택합니다.



- 6  을 눌러 키패드 톤을 활성화하거나 비활성화합니다. 디스플레이에 다음 결과 중 하나가 표시됩니다.



- 활성화되면  아이콘이 활성화 옆에 표시됩니다.
- 비활성화되면  아이콘이 활성화 옆에서 사라집니다.



신호음/경보 볼륨 오프셋 레벨 설정



이 기능은 신호음 또는 경보의 볼륨을 해당 음성의 볼륨보다 크거나 작게 조절합니다. 다음 절차에 따라 무전기에서 신호음 및 경보의 볼륨 오프셋 레벨을 설정합니다.



- 1  버튼을 눌러 메뉴로 이동합니다.

- 2  또는  버튼을 눌러 유틸리티로 이동합니다.  버튼을 눌러 선택합니다.



- 3  또는  버튼을 눌러 무전기 설정으로 이동합니다.  버튼을 눌러 선택합니다.

- 4  또는  버튼을 눌러 톤/경보로 이동합니다.  버튼을 눌러 선택합니다.

5  또는  을 눌러 볼륨 오프셋으로 이동합니다.  버튼을 눌러 선택합니다.

6  또는  버튼을 눌러 원하는 볼륨 오프셋 레벨로 이동합니다.
각각의 해당 볼륨 오프셋 레벨과 함께 피드백 신호음이 울립니다.



7 다음 중 하나를 수행합니다.



-  버튼을 눌러 선택합니다. 원하는 볼륨 오프셋 수준이 저장되었습니다.
- 종료하려면  을 누릅니다. 변경 내용은 무시됩니다.



통화 허용 신호음 켜기 또는 끄기



다음 절차에 따라 무전기에서 통화 허용 신호음을 켜거나 끕니다.

1  버튼을 눌러 메뉴로 이동합니다.

2  또는  버튼을 눌러 유틸리티로 이동합니다.  버튼을 눌러 선택합니다.



3  또는  버튼을 눌러 무전기 설정으로 이동합니다.  버튼을 눌러 선택합니다.

4  또는  버튼을 눌러 톤/경보로 이동합니다.  버튼을 눌러 선택합니다.

5  또는  버튼을 눌러 통화 허용으로 이동합니다.  버튼을 눌러 선택합니다.

6  버튼을 눌러 통화 허용 경보음을 활성화하거나 비활성화합니다.



디스플레이에 다음 결과 중 하나가 표시됩니다.



- 활성화되면  아이콘이 활성화 옆에 표시됩니다.
- 비활성화되면  아이콘이 활성화 옆에서 사라집니다.



전원 켜짐 신호음 켜기 또는 끄기



다음 절차에 따라 무전기에서 전원 켜짐 신호음을 켜거나 끕니다.



- 1  버튼을 눌러 메뉴로 이동합니다.

- 2  또는  버튼을 눌러 유틸리티로 이동합니다.  버튼을 눌러 선택합니다.

- 3  또는  버튼을 눌러 무전기 설정으로 이동합니다.  버튼을 눌러 선택합니다.

- 4  또는  버튼을 눌러 톤/경보로 이동합니다.  버튼을 눌러 선택합니다.



- 5  또는  버튼을 눌러 출력 증강으로 이동합니다.  버튼을 눌러 선택합니다.



- 6  버튼을 눌러 출력 증강 톤을 활성화하거나 비활성화합니다. 디스플레이에 다음 결과 중 하나가 표시됩니다.
 - 활성화되면  아이콘이 활성화 옆에 표시됩니다.
 - 비활성화되면  아이콘이 활성화 옆에서 사라집니다.



문자 메시지 정보음 설정

연락처 목록의 각 항목에 대한 문자 메시지 정보음을 일시적 또는 반복으로 사용자 지정할 수 있습니다. 다음 절차에 따라 무전기에서 문자 메시지 정보음을 설정합니다.







- 1  버튼을 눌러 메뉴로 이동합니다.

- 2  또는  버튼을 눌러 연락처로 이동합니다.  버튼을 눌러 선택합니다.

- 3  또는  버튼을 눌러 원하는 별칭 또는 ID로 이동합니다.  버튼을 눌러 선택합니다.

4  또는  버튼을 눌러 메시지 경보로 이동합니다.  버튼을 눌러 선택합니다.

5 다음 중 하나를 수행합니다.

-  또는  버튼을 눌러 일시적으로 이동합니다.  버튼을 눌러 선택합니다.
✓가 디스플레이의 일시적 옆에 표시됩니다.
-  또는  버튼을 눌러 반복적으로 이동합니다.  버튼을 눌러 선택합니다.
✓가 디스플레이의 반복적 옆에 표시됩니다.



디스플레이 모드 변경



필요에 따라 무전기의 디스플레이 모드를 주간이나 야간으로 변경할 수 있습니다. 이 기능은 디스플레이의 색상표에 영향을 줍니다. 다음 절차에 따라 무전기의 디스플레이 모드를 변경합니다.



1 다음 중 하나를 수행합니다.



- 프로그래밍된 **디스플레이 모드** 버튼을 누릅니다. 다음 단계를 건너뛸니다.

-  버튼을 눌러 메뉴로 이동합니다.

2  또는  버튼을 눌러 유틸리티로 이동합니다.  버튼을 눌러 선택합니다.

3  또는  버튼을 눌러 무전기 설정으로 이동합니다.  버튼을 눌러 선택합니다.



4  또는  버튼을 눌러 디스플레이로 이동합니다.  버튼을 눌러 선택합니다.
디스플레이에 주간 모드와 야간 모드가 표시됩니다.



5  또는  버튼을 눌러 원하는 설정으로 이동합니다.  버튼을 눌러 선택합니다.
디스플레이에서 선택된 설정 옆에 ✓가 표시됩니다.



디스플레이 선명도 조절



다음 절차에 따라 무전기의 디스플레이 선명도를 조절합니다. 밝기 자동이 활성화된 경우에는 디스플레이 밝기를 조절할 수 없습니다.

- 1 다음 중 하나를 수행합니다.
 - 프로그래밍된 **선명도** 버튼을 누릅니다. 다음 단계를 건너뛵니다.
 -  버튼을 눌러 메뉴로 이동합니다.

- 2  또는  버튼을 눌러 유틸리티로 이동합니다.  버튼을 눌러 선택합니다.

- 3  또는  버튼을 눌러 무전기 설정으로 이동합니다.  버튼을 눌러 선택합니다.



- 4  또는  버튼을 눌러 선명도로 이동합니다.  버튼을 눌러 선택합니다. 디스플레이에 선명도 표시줄이 나타납니다.

- 5  또는  버튼을 눌러 디스플레이 선명도를 낮추거나 높입니다.  버튼을 눌러 선택합니다. 설정 값은 1~8 사이입니다.

혼/라이트 켜기 또는 끄기

무전기는 혼 및 라이트 기능을 통해 사용자에게 수신 호출을 알릴 수 있습니다. 활성화된 경우 호출이 들어오면 혼이 울리고 차량의 라이트가 켜집니다. 이 기능은 대리점에서 무전기 후면 액세서리 커넥터를 통해 설치해야 합니다. 다음 절차에 따라 무전기에서 모든 혼 및 라이트를 켜거나 끕니다.

- 1 다음 중 하나를 수행합니다.
 - 프로그래밍된 **혼/라이트** 버튼을 누릅니다. 아래 단계를 건너뛵니다.
 -  버튼을 눌러 메뉴로 이동합니다.

- 2  또는  버튼을 눌러 유틸리티로 이동합니다.  버튼을 눌러 선택합니다.

3 ▲ 또는 ▼ 버튼을 눌러 무전기 설정으로 이동합니다. [OK] 버튼을 눌러 선택합니다.

4 ▲ 또는 ▼ 버튼을 눌러 혼/라이트로 이동합니다. [OK] 버튼을 눌러 선택합니다.

5 [OK] 버튼을 눌러 혼/라이트를 활성화하거나 비활성화합니다. 디스플레이에 다음 결과 중 하나가 표시됩니다.

- 활성화되면 ✓ 아이콘이 활성화 옆에 표시됩니다.
- 비활성화되면 ✓ 아이콘이 활성화 옆에서 사라집니다.

LED 표시등 켜기 또는 끄기

다음 절차에 따라 무전기에서 LED 표시등을 켜거나 끕니다.

1 [OK] 버튼을 눌러 메뉴로 이동합니다.

2 ▲ 또는 ▼ 버튼을 눌러 유틸리티로 이동합니다. [OK] 버튼을 눌러 선택합니다.

3 ▲ 또는 ▼ 버튼을 눌러 무전기 설정으로 이동합니다. [OK] 버튼을 눌러 선택합니다.

4 ▲ 또는 ▼ 버튼을 눌러 LED 표시등으로 이동합니다. [OK] 버튼을 눌러 선택합니다.

5 [OK] 버튼을 눌러 LED 표시를 활성화하거나 비활성화합니다.

디스플레이에 다음 결과 중 하나가 표시됩니다.



- 활성화되면 ✓ 아이콘이 활성화 옆에 표시됩니다.
- 비활성화되면 ✓ 아이콘이 활성화 옆에서 사라집니다.



공용 주소 시스템 켜기 또는 끄기



다음 절차에 따라 무전기의 내부 공용 주소(PA) 시스템을 활성화하거나 비활성화합니다.

1 다음 중 하나를 수행합니다.



- 프로그래밍된 **공용 주소** 버튼을 누릅니다. 다음 단계를 건너뛸니다.
-  버튼을 눌러 메뉴로 이동합니다.

2  또는  버튼을 눌러 유틸리티로 이동합니다.  버튼을 눌러 선택합니다.

3  또는  버튼을 눌러 무전기 설정으로 이동합니다.  버튼을 눌러 선택합니다.

4  또는  버튼을 눌러 공용 주소로 이동합니다.  버튼을 눌러 선택합니다.

5  버튼을 눌러 공용 주소를 활성화하거나 비활성화합니다.



- 활성화되면  아이콘이 활성화 옆에 표시됩니다.
- 비활성화되면  아이콘이 활성화 옆에서 사라집니다.



외부 공용 주소 시스템 켜기 또는 끄기



다음 절차에 따라 무전기의 외부 공용 주소(PA) 시스템을 활성화하거나 비활성화합니다.



1 다음 중 하나를 수행합니다.

- 프로그래밍된 **외부 공용 주소** 버튼을 누릅니다. 다음 단계를 건너뛸니다.
-  버튼을 눌러 메뉴로 이동합니다.

2  또는  버튼을 눌러 유틸리티로 이동합니다.  버튼을 눌러 선택합니다.







3  또는  버튼을 눌러 무전기 설정으로 이동합니다.  버튼을 눌러 선택합니다.



4  또는  버튼을 눌러 외부 공용 주소로 이동합니다.  버튼을 눌러 선택합니다.



- 5  버튼을 눌러 외부 공용 주소를 활성화하거나 비활성화합니다.
- 활성화되면  아이콘이 활성화 옆에 표시됩니다.
 - 비활성화되면  아이콘이 활성화 옆에서 사라집니다.



홈 화면 켜기 또는 끄기

다음 절차에 따라 홈 화면을 활성화하거나 비활성화할 수 있습니다.

- 1  버튼을 눌러 메뉴로 이동합니다.
-
- 2  또는  버튼을 눌러 유틸리티로 이동합니다.  버튼을 눌러 선택합니다.
-
- 3  또는  버튼을 눌러 무전기 설정으로 이동합니다.  버튼을 눌러 선택합니다.

- 4  또는  을 눌러 표시로 이동합니다.  버튼을 눌러 선택합니다.



- 5  또는  을 눌러 초기 화면으로 이동합니다.  버튼을 눌러 선택합니다.



- 6  버튼을 눌러 홈 화면을 활성화하거나 비활성화합니다.
- 디스플레이에 다음 결과 중 하나가 표시됩니다.
- 활성화되면  아이콘이 활성화 옆에 표시됩니다.
 - 비활성화되면  아이콘이 활성화 옆에서 사라집니다.



언어 설정



다음 절차에 따라 무전기에서 언어를 설정합니다.

- 1  버튼을 눌러 메뉴로 이동합니다.

2  또는  버튼을 눌러 유틸리티로 이동합니다.  버튼을 눌러 선택합니다.

3  또는  버튼을 눌러 무전기 설정으로 이동합니다.  버튼을 눌러 선택합니다.



4  또는  을 눌러 언어로 이동합니다.  버튼을 눌러 선택합니다.



5  또는  버튼을 눌러 원하는 언어로 이동합니다.  버튼을 눌러 선택합니다.
디스플레이에서 선택한 언어 옆에 ✓가 표시됩니다.



케이블 타입 식별

무전기에 사용되는 케이블 유형을 선택하려면 다음 단계를 수행하십시오.

1  버튼을 눌러 메뉴로 이동합니다.

2  또는  버튼을 눌러 유틸리티로 이동합니다.  버튼을 눌러 선택합니다.

3  또는  버튼을 눌러 무전기 설정으로 이동합니다.  버튼을 눌러 선택합니다.

4  또는  버튼을 눌러 케이블 타입으로 이동합니다.  버튼을 눌러 선택합니다.

5 현재 케이블 타입은 ✓로 표시됩니다.

음성 활성화 송신

음성 활성화 송신(VOX)을 사용하면 프로그래밍된 채널에서 핸즈프리 음성이 활성화된 호출을 시작할 수 있습니다. 무전기에서는 프로그래밍된 기간 동안, VOX 가능 액세서리의 마이크가 음성을 감지할 때마다 자동으로 송신합니다.



주의:

이 기능은 동일한 주파수에 있는 Citizens 대역 채널에는 적용되지 않습니다.

다음 중 하나를 수행하여 VOX를 활성화 또는 비활성화할 수 있습니다.

- 무전기를 켜다가 다시 전원을 켜서 VOX를 활성화합니다.
- 위로 스크롤/아래로 스크롤 버튼으로 채널을 변경하여 VOX를 활성화합니다.
- 볼륨/채널 노브로 채널을 변경하여 VOX를 활성화합니다.
- 프로그래밍된 **VOX** 버튼을 통해 VOX를 켜고 끄거나 메뉴를 통해 VOX를 활성화하거나 비활성화할 수 있습니다.
- 무전기 작동 중 **PTT** 버튼을 누르면 VOX가 비활성화됩니다.



주의:

이 기능을 켜거나 끄는 것은 이 기능이 활성화된 무전기에만 적용됩니다. 자세한 내용은 대리점이나 시스템 관리자에게 문의하십시오.

음성 활성화 전송 켜기 또는 끄기

다음 절차에 따라 무전기에서 VOX를 켜거나 끕니다.

- 1 다음 중 하나를 수행합니다.

- 프로그래밍된 **VOX** 버튼을 누릅니다. 아래 단계를 건너뛴니다.
- 버튼을 눌러 메뉴로 이동합니다.

- 2 또는 버튼을 눌러 유틸리티로 이동합니다. 버튼을 눌러 선택합니다.

- 3 또는 버튼을 눌러 무전기 설정으로 이동합니다. 버튼을 눌러 선택합니다.

- 4 또는 버튼을 눌러 VOX로 이동합니다. 버튼을 눌러 선택합니다.

- 5 을 눌러 **VOX**를 활성화하거나 비활성화합니다.



주의:

통화 허용 신호음이 활성화된 경우 트리거 단어를 사용하여 호출을 시작합니다. 통화 허용 신호음이 끝날 때까지 기다렸다가 마이크에 대고 명확히 말합니다. 자세한 내용은 **통화 허용 신호음 켜기 또는 끄기 페이지의 190** 부분을 참조하십시오.

음성 안내 켜기 또는 끄기

이 기능을 사용하면 무전기에서 사용자가 방금 지정한 현재 존 또는 채널이나 사용자가 방금 누른 프로그래밍 가능 버튼을 청각적으로 나타낼 수 있습니다.

이 기능은 사용자가 디스플레이에 표시된 내용을 읽는 데 어려움을 겪고 있을 때 특히 유용합니다.

이 오디오 표시 기능은 고객 요구에 따라 사용자 정의할 수 있습니다. 다음 절차에 따라 무전기에서 음성 안내를 켜거나 끕니다.

옵션 보드 켜기 또는 끄기

각 채널 내의 옵션 보드 기능을 프로그래밍 가능 버튼에 지정할 수 있습니다. 하나의 채널에서 최대 6개 옵션 보드 기능을 지원할 수 있습니다. 다음 절차에 따라 무전기에서 옵션 보드를 켜거나 끕니다.

프로그래밍된 **옵션 보드** 버튼을 누릅니다.

TTS

TTS 기능은 대리점이나 시스템 관리자만 활성화할 수 있습니다. TTS 기능이 활성화되면 음성 안내 기능이 자동으로 비

활성화됩니다. 음성 안내 기능이 활성화되면 TTS 기능이 자동으로 비활성화됩니다.





이 기능은 무전기에서 다음 기능을 소리로 나타냅니다.



- 현재 채널
- 현재 존
- 프로그래밍된 버튼 기능 켜기/끄기
- 수신된 문자 메시지의 내용
- 수신된 작업 티켓의 내용



이 오디오 표시 기능은 고객 요구에 맞게 사용자 정의할 수 있습니다. 이 기능은 사용자가 디스플레이에 표시된 내용을 읽기 어려운 상황일 때 특히 유용합니다.



TTS 설정

다음 절차에 따라 TTS 기능을 설정합니다.

- 1  버튼을 눌러 메뉴로 이동합니다.
- 2  또는  버튼을 눌러 유틸리티로 이동합니다.  버튼을 눌러 선택합니다.

3  또는  버튼을 눌러 무전기 설정으로 이동합니다.  버튼을 눌러 선택합니다.

4  또는  버튼을 눌러 음성 안내로 이동합니다.  버튼을 눌러 선택합니다.

5  또는  을 눌러 다음 기능 중 하나로 이동합니다.  버튼을 눌러 선택합니다.
사용할 수 있는 기능은 다음과 같습니다.



- 모두
- 메시지
- 작업 티켓
- 채널
- 구역
- 프로그램 버튼



✓ 선택한 설정 옆에 가 표시됩니다.



자동 호출 전달 켜기 또는 끄기

자동으로 음성 호출을 다른 무전기로 전달하도록 무전기를 설정할 수 있습니다.



1  버튼을 눌러 메뉴로 이동합니다.



2  또는  버튼을 눌러 유틸리티로 이동합니다.  버튼을 눌러 선택합니다.

3  또는  버튼을 눌러 무전기 설정으로 이동합니다.  버튼을 눌러 선택합니다.

4  또는  버튼을 눌러 호출 전달로 이동합니다.  버튼을 눌러 선택합니다.











5 다음 중 하나를 수행합니다.







-  또는  버튼을 눌러 호출 전달을 활성화합니다. 활성화되면 ✓ 아이콘이 활성화 옆에 표시됩니다.

-  또는  버튼을 눌러 호출 전달을 비활성화합니다. 비활성화되면  아이콘이 활성화 옆에서 사라집니다.

메뉴 타이머 설정

무전기가 홈 화면으로 자동 전환되기 전에 메뉴에 머무를 시간을 설정할 수 있습니다. 다음 절차에 따라 메뉴 타이머를 설정합니다.





- 1  버튼을 눌러 메뉴로 이동합니다.
- 2  또는  버튼을 눌러 유틸리티로 이동합니다.  버튼을 눌러 선택합니다.
- 3  또는  버튼을 눌러 무전기 설정으로 이동합니다.  버튼을 눌러 선택합니다.
- 4  또는  버튼을 눌러 디스플레이로 이동합니다.  버튼을 눌러 선택합니다.



- 5  또는  버튼을 눌러 메뉴 타이머로 이동합니다.  버튼을 눌러 선택합니다.
- 6  또는  버튼을 눌러 원하는 설정으로 이동합니다.  버튼을 눌러 선택합니다.



아날로그 마이크 AGC 켜기 또는 끄기

아날로그 마이크 AGC(자동 게인 제어)는 아날로그 시스템에서 송신하는 동안 자동으로 무전기의 마이크 게인을 제어합니다.

이 기능을 사용하면 일정한 수준의 음량을 제공하기 위해 큰 소리가 억제되거나 작은 소리가 미리 설정된 값만큼 커집니다. 다음 절차에 따라 무전기에서 아날로그 마이크 AGC를 켜거나 끕니다.



- 1  버튼을 눌러 메뉴로 이동합니다.
- 2  또는  버튼을 눌러 유틸리티로 이동합니다.  버튼을 눌러 선택합니다.

3  또는  버튼을 눌러 무전기 설정으로 이동합니다.  버튼을 눌러 선택합니다.

4  또는  버튼을 눌러 마이크 AGC-A로 이동합니다.  버튼을 눌러 선택합니다.



5  버튼을 눌러 아날로그 마이크 AGC를 활성화하거나 비활성화합니다.



디스플레이에 다음 결과 중 하나가 표시됩니다.



- 활성화되면  아이콘이 활성화 옆에 표시됩니다.
- 비활성화되면  아이콘이 활성화 옆에서 사라집니다.

다. 다음 절차에 따라 무전기에서 디지털 마이크 AGC를 켜거나 끕니다.

1  버튼을 눌러 메뉴로 이동합니다.

2  또는  버튼을 눌러 유틸리티로 이동합니다.  버튼을 눌러 선택합니다.

3  또는  버튼을 눌러 무전기 설정으로 이동합니다.  버튼을 눌러 선택합니다.

4  또는  버튼을 눌러 마이크 AGC-D로 이동합니다.  버튼을 눌러 선택합니다.

5  을 눌러 디지털 마이크 AGC를 활성화하거나 비활성화합니다.

디스플레이에 다음 결과 중 하나가 표시됩니다.

- 활성화되면  아이콘이 활성화 옆에 표시됩니다.

디지털 마이크 AGC 켜기 또는 끄기

디지털 마이크 AGC(자동 게인 제어)는 디지털 시스템에서 전송하는 동안 자동으로 무전기의 마이크 게인을 제어합니다.

이 기능을 사용하면 일정한 수준의 음량을 제공하기 위해 큰 소리가 억제되거나 작은 소리가 미리 설정된 값만큼 커집니다.

- 비활성화되면  아이콘이 활성화 옆에서 사라집니다.

지능형 오디오 켜기 또는 끄기



정상성 잡음원과 비정상성 잡음원 모두를 포함하여 환경의 현재 주변 소음을 억제하기 위해 무전기의 오디오 볼륨이 자동으로 조절됩니다. 이 기능은 수신 전용 기능이며 전송음에는 영향을 주지 않습니다. 다음 절차에 따라 무전기에서 지능형 오디오를 켜거나 끕니다.









주의:

이 기능은 Bluetooth 세션 중에는 적용되지 않습니다.









- 1 다음 중 하나를 수행합니다.
 - 프로그래밍된 **지능형 오디오** 버튼을 누릅니다. 아래 단계를 건너뛴니다.
 -  버튼을 눌러 메뉴로 이동합니다.

- 2  또는  버튼을 눌러 유틸리티로 이동합니다.  버튼을 눌러 선택합니다.

- 3  또는  버튼을 눌러 무전기 설정으로 이동합니다.  버튼을 눌러 선택합니다.

- 4  또는  버튼을 눌러 지능형 오디오로 이동합니다.  버튼을 눌러 선택합니다.



- 5 다음 중 하나를 수행합니다.



-  또는  버튼을 눌러 켜기로 이동합니다.  버튼을 눌러 선택합니다.  가 디스플레이의 켜기 옆에 표시됩니다.
-  또는  버튼을 눌러 끄기로 이동합니다.  버튼을 눌러 선택합니다.  가 디스플레이의 끄기 옆에 표시됩니다.



음향 피드백 억제기 기능 켜기 또는 끄기



이 기능은 수신된 호출에서 발생하는 음향 피드백 억제를 최소화합니다. 다음 절차에 따라 무전기에서 음향 피드백 억제기를 켜거나 끕니다.

- 1  버튼을 눌러 메뉴로 이동합니다.

- 2  또는  버튼을 눌러 유틸리티로 이동합니다.  버튼을 눌러 선택합니다..

- 3  또는  버튼을 눌러 무전기 설정으로 이동합니다.  버튼을 눌러 선택합니다.



- 4  또는  버튼을 눌러 AF 억제기로 이동합니다.  버튼을 눌러 선택합니다.



- 5 다음 중 하나를 수행합니다.
 - 을 눌러 음향 피드백 억제기를 활성화합니다. 활성화되면  아이콘이 활성화 옆에 표시됩니다.
 - 을 눌러 음향 피드백 억제기를 비활성화합니다. 비활성화되면  아이콘이 활성화 옆에서 사라집니다.



트릴 강화 켜기 또는 끄기

치경음 트릴(굴리는 "R") 발음이 있는 단어가 많이 포함된 언어로 이야기할 경우 이 기능을 활성화할 수 있습니다. 다음 절차에 따라 무전기에서 트릴 강화를 켜거나 끕니다.







- 1 다음 중 하나를 수행합니다.
 - 프로그래밍된 **트릴 강화** 버튼을 누릅니다. 아래 단계를 건너뛴니다.
 -  버튼을 눌러 메뉴로 이동합니다.

- 2  또는  버튼을 눌러 유틸리티로 이동합니다.  버튼을 눌러 선택합니다.

- 3  또는  버튼을 눌러 무전기 설정으로 이동합니다.  버튼을 눌러 선택합니다.

- 4  또는  버튼을 눌러 트릴 강화로 이동합니다.  버튼을 눌러 선택합니다.

- 5 다음 중 하나를 수행합니다.

-  또는  버튼을 눌러 켜기로 이동합니다.
 버튼을 눌러 선택합니다. ✓가 디스플레이의 켜기 옆에 표시됩니다.
-  또는  버튼을 눌러 끄기로 이동합니다.
 버튼을 눌러 선택합니다. ✓가 디스플레이의 끄기 옆에 표시됩니다.

오디오 환경

사용자 환경에 따라 무전기의 오디오 환경을 사용자 정의할 수 있습니다.

기본

기본 설정입니다.

크게

이 설정은 잡음 방지 장치를 활성화하고 주변 소음이 심한 환경에서 사용할 수 있도록 스피커 볼륨을 높입니다.



작업 그룹



이 설정은 무전기 그룹이 서로 근처에 있을 때 AF 억제기를 활성화하고 AGC를 비활성화하여 사용합니다.



오디오 환경 설정



다음 절차에 따라 무전기에서 환경에 적합한 오디오 환경을 설정합니다.

- 1  버튼을 눌러 메뉴로 이동합니다.

- 2  또는  버튼을 눌러 유틸리티로 이동합니다.  버튼을 눌러 선택합니다.

- 3  또는  버튼을 눌러 무전기 설정으로 이동합니다.  버튼을 눌러 선택합니다.

- 4  또는  버튼을 눌러 오디오 환경으로 이동합니다.  버튼을 눌러 선택합니다.

- 5  또는  버튼을 눌러 원하는 설정으로 이동합니다.  버튼을 눌러 선택합니다.
설정은 다음과 같습니다.
 - 출하시 기본 설정은 기본값을 선택합니다.

- 주변 소음이 심한 환경에서 스피커 볼륨을 높이려면 크게를 선택합니다.
 - 서로 인접한 무전기 그룹으로 사용할 때 음향 피드백을 줄이려면 작업 그룹을 선택합니다.
- 디스플레이에서 선택된 설정 옆에 ✓가 표시됩니다.

오디오 프로필

사용자 선호도에 따라 무전기의 오디오 프로필을 사용자 정의할 수 있습니다.

기본

기본 설정입니다.

레벨 1, 레벨 2 및 레벨 3













이 설정은 40대, 50대 및 60대 이상 성인에게 흔한 소음성 난청을 보완하기 위해 고안되었습니다.

고음 강조, 중음 강조 및 저음 강조

이 설정은 날카로운 소리, 비음이 높은 소리. 깊은 소리를 강조할 수 있도록 고안되었습니다.

오디오 프로필 설정

다음 절차에 따라 무전기에서 오디오 프로필을 설정합니다.

- 1  버튼을 눌러 메뉴로 이동합니다.
- 2  또는  버튼을 눌러 유틸리티로 이동합니다.  버튼을 눌러 선택합니다.
- 3  또는  버튼을 눌러 무전기 설정으로 이동합니다.  버튼을 눌러 선택합니다.
- 4  또는  버튼을 눌러 오디오 프로필로 이동합니다.  버튼을 눌러 선택합니다.
- 5  또는  버튼을 눌러 원하는 설정으로 이동합니다.  버튼을 눌러 선택합니다.
 설정은 다음과 같습니다.
 - 기본값을 선택하여 이전에 선택한 오디오 프로필을 비활성화하고 출하시 기본값으로 돌아갑니다.
 - 40대 이상 성인에게 흔한 소음성 난청을 보완하기 위해 고안된 오디오 프로필로 레벨 1, 레벨 2 또는 레벨 3을 선택합니다.

- 날카로운 소리, 비음 또는 깊은 소리에 대한 기본 설정을 지정하는 오디오 프로필로 고음 강조, 중음 강조 또는 저음 강조를 선택합니다.

디스플레이에서 선택된 설정 옆에 ✓가 표시됩니다.

GNSS 켜기 또는 끄기



GNSS(위성항법시스템)는 무전기의 정확한 위치를 결정하는 위성 탐색 시스템입니다. GNSS에는 GPS(Global Positioning System) 및 BDS(BeiDou Navigation Satellite System)가 포함됩니다.









주의:

선택한 무전기 모델은 GPS 및 BDS를 제공할 수 있습니다. GNSS 위성항법 시스템은 CPS를 사용하여 구성됩니다. 무전기가 프로그래밍된 방식에 대해서는 대리점이나 시스템 관리자에게 문의하십시오.

- 1 다음 단계 중 하나를 수행하여 무전기에서 GNSS를 켜거나 끕니다.
 - 프로그래밍된 **GNSS** 버튼을 누릅니다.
 -  버튼을 눌러 메뉴로 이동합니다. 다음 단계로 진행합니다.

- 2  또는  버튼을 눌러 유틸리티로 이동합니다.  버튼을 눌러 선택합니다.

- 3  또는  버튼을 눌러 무전기 설정으로 이동합니다.  버튼을 눌러 선택합니다.

- 4  또는  을 눌러 GNSS로 이동합니다.  버튼을 눌러 선택합니다.











- 5  버튼을 눌러 GNSS를 활성화하거나 비활성화합니다.
 활성화되면 ✓아이콘이 활성화 옆에 표시됩니다.
 비활성화되면 ✓아이콘이 활성화 옆에서 사라집니다.

유연한 수신 목록

유연한 수신 목록은 수신 통화 그룹 목록에 구성원을 만들고 지정할 수 있는 기능입니다. 무전기에서는 목록에서 최대 16명의 멤버를 지원할 수 있습니다. (이 기능은 Capacity Plus에서 지원됩니다.)

유연한 수신 목록 켜기 또는 끄기

아래 절차에 따라 유연한 수신 목록을 켜거나 끌 수 있습니다.

- 다음 중 하나를 수행합니다.
 - 프로그래밍된 **유연한 수신 목록** 버튼을 누릅니다. 다음 단계를 건너뛸니다.
 -  버튼을 눌러 메뉴로 이동합니다.
-  또는  을 눌러 유연한 수신 목록으로 이동합니다.  버튼을 눌러 선택합니다.
- 다음 중 하나를 수행합니다.
 -  또는  버튼을 눌러 켜기로 이동합니다.  버튼을 눌러 선택합니다. 선택음이 울립니다. 디스플레이에 선택 미니 알림이 표시됩니다.
 -  또는  버튼을 눌러 끄기로 이동합니다.  버튼을 눌러 선택합니다. 해제음이 울립니다.

디스플레이에 해제 미니 알림이 표시됩니다.

일반 무전기 정보

무전기에는 다양한 일반 매개변수에 대한 정보가 포함되어 있습니다.

무전기의 일반 정보는 다음과 같습니다.

- 무전기 별칭 및 ID.
- 펌웨어 및 코드플러그 버전.
- 소프트웨어 업데이트.
- GNSS 정보.
- 사이트 정보.



주의:

이전 화면으로 돌아가려면  버튼을 누릅니다.

홈 화면으로 돌아가려면  버튼을 길게 누릅니다. 무전기는 비활성 타이머가 만료되는 즉시 현재 화면을 종료합니다.

무전기 별칭 및 ID 확인



다음 절차에 따라 무전기에서 무전기 별칭 및 ID를 확인합니다.



1 다음 중 하나를 수행합니다.



- 프로그래밍된 **무전기 별칭 및 ID** 버튼을 누릅니다.
다음 단계를 건너뛴니다.
선택음이 울립니다.

프로그래밍된 **무전기 별칭 및 ID** 버튼을 눌러 이전 화면으로 돌아갈 수 있습니다.

-  버튼을 눌러 메뉴로 이동합니다.

2  또는  버튼을 눌러 유틸리티로 이동합니다.  버튼을 눌러 선택합니다.



3  또는  버튼을 눌러 무전기 정보로 이동합니다.  버튼을 눌러 선택합니다.



4  또는  을 눌러 내 ID로 이동합니다.  버튼을 눌러 선택합니다.
첫 번째 텍스트 줄에 무전기 별칭이 표시됩니다. 두 번째 텍스트 줄에 무전기 ID가 표시됩니다.



펌웨어 및 코드플러그 버전 확인

다음 절차에 따라 무전기의 펌웨어 및 코드플러그 버전을 확인합니다.

1  버튼을 눌러 메뉴로 이동합니다.

2  또는  버튼을 눌러 유틸리티로 이동합니다.  버튼을 눌러 선택합니다.

3  또는  버튼을 눌러 무전기 정보로 이동합니다.  버튼을 눌러 선택합니다.



4  또는  버튼을 눌러 버전으로 이동합니다.  버튼을 눌러 선택합니다.



디스플레이에 현재 펌웨어 및 코드플러그 버전이 표시됩니다.



소프트웨어 업데이트 정보 확인

이 기능을 사용하면 최근에 OTAP 또는 Wi-Fi를 통해 수행된 소프트웨어 업데이트의 날짜와 시간이 표시됩니다. 다음 절차에 따라 무전기에서 소프트웨어 업데이트 정보를 확인합니다.

- 1  버튼을 눌러 메뉴로 이동합니다.

- 2  또는  버튼을 눌러 유틸리티로 이동합니다.  버튼을 눌러 선택합니다.

- 3  또는  버튼을 눌러 무전기 정보로 이동합니다.  버튼을 눌러 선택합니다.

- 4  또는  버튼을 눌러 소프트웨어 업데이트로 이동합니다.  버튼을 눌러 선택합니다.
디스플레이에 최신 소프트웨어 업데이트 날짜와 시간이 표시됩니다.

소프트웨어 업데이트 메뉴는 성공한 OTAP 또는 Wi-Fi 세션이 하나 이상 있을 때만 사용할 수 있습니다. 자세한 내용은



OTAP(무선 프로그래밍) 페이지의 451 부분을 참조하십시오.

GNSS 정보 확인

무전기에 다음과 같은 GNSS 정보를 표시합니다.

- 위도
- 경도
- 고도
- 방향
- 속도
- HDOP(Horizontal Dilution of Precision)
- 위성 수
- 버전

- 1  버튼을 눌러 메뉴로 이동합니다.

- 2  또는  버튼을 눌러 유틸리티로 이동합니다.  버튼을 눌러 선택합니다.

3 ▲ 또는 ▼ 버튼을 눌러 무전기 정보로 이동합니다.  버튼을 눌러 선택합니다.

4 ▲ 또는 ▼ 버튼을 눌러 GNSS 정보로 이동합니다.  버튼을 눌러 선택합니다.

5 ▲ 또는 ▼ 버튼을 눌러 원하는 항목으로 이동합니다.  버튼을 눌러 선택합니다. 디스플레이에 요청한 GNSS 정보가 표시됩니다.

사이트 정보 표시

다음 절차에 따라 무전기가 켜져 있는 현재 사이트의 이름을 표시합니다.

1  버튼을 눌러 메뉴로 이동합니다.

2 ▲ 또는 ▼ 버튼을 눌러 유틸리티로 이동합니다.  버튼을 눌러 선택합니다.

3 ▲ 또는 ▼ 버튼을 눌러 무전기 정보로 이동합니다.  버튼을 눌러 선택합니다.

4 ▲ 또는 ▼ 버튼을 눌러 사이트 정보로 이동합니다.  버튼을 눌러 선택합니다.

디스플레이에 현재 사이트 이름이 표시됩니다.

기업 Wi-Fi 인증서 세부 정보 보기



선택한 기업 Wi-Fi 인증서의 세부 정보를 볼 수 있습니다.

1  버튼을 눌러 메뉴로 이동합니다.

2 ▲ 또는 ▼ 버튼을 눌러 유틸리티로 이동합니다.  버튼을 눌러 선택합니다.

3 ▲ 또는 ▼ 버튼을 눌러 인증서 메뉴로 이동합니다.  버튼을 눌러 선택합니다.

✓가 준비된 인증서 옆에 나타납니다.

- 4  또는  버튼을 눌러 필요한 인증서로 이동합니다.  버튼을 눌러 선택합니다.
-

무전기에 인증서의 전체 세부 정보가 표시됩니다.



주의:

인증서가 준비되지 않은 경우, 디스플레이에는 상태만 표시됩니다.

승인된 액세스서리 목록

Motorola Solutions은 무전기의 생산성을 향상시키는 액세스서리 목록을 제공합니다.

안테나

- 콤비네이션 GNSS(GPS/Galileo/QZSS/GLONASS), UHF, 403–527MHz, 2.0dB 게인, 구멍 관통 장착형, BNC(HAE6017_)
- 콤비네이션 GPS/UHF, 470 – 527MHz, 1/4 웨이브, 구멍 관통 장착형, BNC(HAE6018_)
- UHF, 403–527MHz, 2.0dB 게인, 구멍 관통 장착형, BNC(HAE6021_)
- 콤비네이션 GPS/UHF, 494 – 512MHz, 3.0dB 게인, 구멍 관통 장착형, BNC(HAE6023_)
- 콤비네이션 GPS/UHF, 470 – 494MHz, 3.0dB 게인, 구멍 관통 장착형, BNC(HAE6025_)
- 800/900, 806 – 941MHz, 스테리비, 구멍 관통 장착형, 미니-U(HAF4013_)
- 800/900, 806 – 941MHz, 1/4 웨이브, 구멍 관통 장착형, 미니-U(HAF4025_)
- 800/900, 806 – 941MHz, 3db 게인, 구멍 관통 장착형, 미니-U(HAF4026_)
- 800/900, 806–941MHz, 5.0dB 게인, 구멍 관통 장착형, 미니-U(HAF4027_)
- 콤비네이션 GPS+RF, 806–941MHz, 1/4 웨이브, 구멍 관통 장착형, 미니-U(HAF4029_)
- 콤비네이션 GPS+RF, 806–941MHz, 3.0dB 게인, 구멍 관통 장착형, 미니-U(HAF4030_)
- 콤비네이션 GPS+RF, 806–941MHz, 5.0dB 게인, 구멍 관통 장착형, 미니-U(HAF4032_)
- 콤비네이션 GPS+RF, 806–941MHz, 5.0dB 게인, 구멍 관통 장착형, 미니-U(HAF4033_)
- UHF, 300–340MHz, 1/4 웨이브, 구멍 관통 장착형, BNC(PMAD4140_)
- 콤비네이션 GPS/GNSS/UHF, 350–400MHz, 1/4 웨이브, 구멍 관통 장착형, BNC(PMAD4102_)
- UHF, 350–400MHz, 1/4 웨이브, 구멍 관통 장착형, BNC(PMAD4107_)
- UHF, 320–360MHz, 1/4 웨이브, 구멍 관통 장착형, BNC(PMAD4141_)

- 콤비네이션 GNSS(GPS/Galileo/QZSS/GLONASS), UHF, 300–340MHz, 1/4 웨이브, 구멍 관통 장착형, BNC(PMAD4142_)
- 콤비네이션 GNSS(GPS/Galileo/QZSS/GLONASS), UHF, 320–360MHz, 1/4 웨이브, 구멍 관통 장착형, BNC(PMAD4143_)
- 콤비네이션 GNSS(GPS/Galileo/QZSS/GLONASS), UHF, 403–430MHz, 1/4 웨이브, 구멍 관통 장착형, BNC(PMAE4035_)
- 콤비네이션 GNSS(GPS/Galileo/QZSS/GLONASS), UHF, 406–420MHz, 3.5dB 게인, 구멍 관통 장착형, BNC(PMAE4036_)
- 콤비네이션 GNSS(GPS/Galileo/QZSS/GLONASS), UHF, 450–470MHz, 1/4 웨이브, 구멍 관통 장착형, BNC(PMAE4037_)
- 콤비네이션 GNSS(GPS/Galileo/QZSS/GLONASS), UHF, 450–470MHz, 5dB 게인, 구멍 관통 장착형, BNC(PMAE4038_)
- 고정 장착형 GPS 활성 안테나(PMAN4000_)
- 윈도우 장착형 GPS 활성 안테나(PMAN4001_)
- 자기 장착형 GPS 활성 안테나(PMAN4002_)
- 콤비네이션 GNSS(GPS/Galileo/QZSS/BeiDou-2), NMO 장착 베이스, BNC(PMAN4003_)
- VHF, 136–144MHz, 1/4 웨이브, 구멍 관통 장착형, BNC(RAD4198_)
- VHF, 146–150.8MHz, 1/4 웨이브, 구멍 관통 장착형, BNC(RAD4199_)
- VHF, 150.8–162MHz, 1/4 웨이브, 구멍 관통 장착형, BNC(RAD4200_)
- VHF, 162–174MHz, 1/4 웨이브, 구멍 관통 장착형, BNC(RAD4201_)
- 콤비네이션 GNSS(GPS/Galileo/QZSS/GLONASS), VHF, 136–144MHz, 1/4 웨이브, 구멍 관통 장착형, BNC(RAD4219_)
- 콤비네이션 GNSS(GPS/Galileo/QZSS/GLONASS), VHF, 146–150.8MHz, 1/4 웨이브, 구멍 관통 장착형, BNC(RAD4220_)
- 콤비네이션 GNSS(GPS/Galileo/QZSS/GLONASS), VHF, 150.8–162MHz, 1/4 웨이브, 구멍 관통 장착형, BNC(RAD4221_)
- 콤비네이션 GNSS(GPS/Galileo/QZSS/GLONASS), VHF, 162–174MHz, 1/4 웨이브, 구멍 관통 장착형, BNC(RAD4222_)
- UHF, 403–430MHz, 1/4 웨이브, 구멍 관통 장착형, BNC(RAE4151_)

- UHF, 450–470MHz, 1/4 웨이브, 구멍 관통 장착형, BNC(RAE4152_)
- UHF, 450–470MHz, 5.0dB 게인, 구멍 관통 장착형, BNC(RAE4154_)
- UHF, 406–420MHz, 3.5dB 게인, 구멍 관통 장착형, BNC(RAE4158_)

기본 **PMAN4003_** 에 사용하는 경우에만 해당:

- UHF, 494–512MHz, 3.0dB 게인, 구멍 관통 장착형 (HAE6027_)
- UHF, 470–494MHz, 3.0dB 게인, 구멍 관통 장착형 (HAE6028_)
- UHF, 403–527MHz, 2.0dB 게인, 구멍 관통 장착형 (HAE6029_)(표준 안테나 기반에서도 사용)
- UHF, 470–527MHz, 1/4 웨이브, 구멍 관통 장착형 (HAE6030_)
- UHF, 403–430MHz, 1/4 웨이브(PMAE4039_)
- UHF, 450–470MHz, 1/4 웨이브(PMAE4041_)
- UHF, 406–420MHz, 3.5dB 게인(PMAE4040_)
- UHF, 450–470MHz, 3.5dB 게인(PMAE4042_)
- UHF, 450–470MHz, 5.0dB 게인(PMAE4043_)
- VHF, 162–174MHz, 1/4 웨이브(RAD4223_)

- VHF, 150.8–162MHz, 1/4 웨이브(RAD4224_)
- VHF, 146–150.8MHz, 1/4 웨이브(RAD4225_)
- VHF, 136–144MHz, 1/4 웨이브(RAD4226_)
- VHF, 146–172MHz, 3.0dB 게인(RAD4227_)

오디오 액세스리

- HK200 블루투스 헤드셋(미국 플러그)(89409N)
- HK200 블루투스 헤드셋(영국 플러그)(ASMHK200VP-GB2A)
- HK200 블루투스 헤드셋(유럽 플러그)(ASMHK200-GB3A)
- HK200 블루투스 헤드셋(한국 플러그)(ASMHK200-KR2A)
- HK200 블루투스 헤드셋(중국 플러그)(ASMHK200-CN2A)
- HK200 블루투스 헤드셋(호주 플러그)(ASMHK200-AU2A)
- 전화기형 핸드셋(HMN4098_)
- 업무 수행용 무선 이어폰, 12인치 케이블(NNTN8125_)
- 업무 수행용 무선 이어폰, 9.5인치 케이블(NNTN8126_)
- 업무 수행용 무선 PTT POD(NNTN8127_)

- 비보안 무선 헤드셋 및 PTT 오디오를 갖춘 PTT 장치, 12인치 케이블 (NNTN8189_)
- Bluetooth 액세스리 키트, SP, 9.5인치 케이블 (NNTN8190_)
- 무선 비밀 키트: 2선 이어버드 두 세트(검정색 1개 및 흰색 1개), 1선 이어버드(검은색) 및 모든 기성품 헤드폰에 연결 가능한 3.5mm 어댑터 포함(NNTN8296_) ¹⁴
- 완전한 서베일런스 키트용 무선 넥루프 Y 어댑터 및 유지 후크(NNTN8385_) ¹⁶
- 비즈니스 무선 액세스리 키트(PMLN6463_)
- 무선 R2.17A 장거리 원격 스피커 마이크(PMMN4095_)
- 무선 R2.17 모바일 마이크 게이트웨이(PMMN4097_)
- 유연하게 맞는 회전형 이어폰, 붐 마이크 포함 (PMLN7181_) ¹⁶
- 유연하게 맞는 회전형 이어폰, 붐 마이크 포함, 멀티팩 (PMLN7203_) ¹⁶
- 완전한 서베일런스 이어피스 키트(RLN4922_) ¹⁶
- XBT 넥 밴드, 비보안 무선 헤비듀티 헤드셋(RLN6490_)
- XBT 오버헤드, 비보안 무선 헤비듀티 헤드셋 (RLN6491_)
- 회전형 이어폰, Bluetooth 액세스리 키트 포드용 인라인 마이크 포함, 3개 팩(RLN6550_) ¹⁶
- 탁상용 마이크(RMN5050_)
- 소형 마이크(RMN5052_)
- IMPRES 4방향 탐색 키패드 마이크(RMN5127_)
- 오디오 성능이 향상된 헤비듀티 마이크(RMN5053_)
- 오디오 성능이 향상된 바이저 마이크(RMN5054_)

케이블

- 소형 마이크 교체 케이블(3075336B07)
- 헤비듀티/키패드 마이크 교체 케이블(3075336B10)
- 배터리 전원 케이블, 3미터(10피트) 케이블, 15암페어(1-25W)(HKN4137_)
- 배터리 전원 케이블, 3미터(10피트) 케이블, 20암페어(1-45W)(HKN4191_)
- 배터리 전원 케이블, 6미터(20피트) 케이블, 20암페어(1-45W)(HKN4192_)
- 모바일 전면(MMP) 프로그래밍 케이블(HKN6184_)
- MAP 프로그래밍 케이블(PMKN4010_)

¹⁴ 본 무전기가 여기에 나열된 액세스리와 호환됩니다. 자세한 내용은 대리점에 문의하십시오.

- MAP 프로그래밍 및 테스트 케이블(PMKN4016_)
- 모바일 및 증계기 후면 액세스리 커넥터 유니버설 케이블(PMKN4018_)
- 차량용 마이크 연장 케이블, 10피트(PMKN4033_)
- 차량용 마이크 연장 케이블, 20피트(PMKN4034_)
- 원격 장착(3미터) 케이블(PMKN4143_)
- 원격 장착(5미터) 케이블(PMKN4144_)
- 시동 감지 케이블(RKN4136_)

탁상용 액세스리

- 미국 전선 코드(3060665A04)
- GPN6145용 무전기 전원 케이블(GKN6266_)
- 스피커 미장착 탁상 트레이(GLN7318_)
- 스위치 모드 전원 케이블(1 – 25와트 모델)(CE 마크)(GPN6145_)
- 전원 공급 장치 및 케이블(HPN4007_)
- 전원 공급 장치 14볼트 15암페어 UNI 117/240 VAC(영국 플러그)(HPN4011_)

- 전원 공급 장치 14볼트 15암페어 UNI 117/240 VAC(미국 플러그)(HPN4007_)
- 후면 액세스리 커넥터용 하드웨어 키트(PMLN5072_)
- 스피커 장착 탁상 트레이(GSN4005_)

장착 키트

- 스크린 보호 덮개, 투명(팩당 장치 1개)(AY000269A01_)¹⁵
- 대시보드 내부(DIN) 장착 키트(RLN6465_)
- 로우 프로파일 트러니온 키트(RLN6466_)
- 하이 프로파일 트러니온 키트(RLN6467_)
- 키 잠금식 트러니온 키트(RLN6468_)
- 로우 프로파일 트러니온 - 가방(RLN6469_)
- 원격 장착 트랜시버 인터페이스(PMLN6402_)
- 원격 장착 컨트롤 헤드 인터페이스(PMLN6403_)

기타 액세스리

- 과부하 보호 장치, 타워 장착 키트(DQT1)

¹⁵ 본 무전기는 여기에 나열된 액세스리와 호환됩니다. 자세한 내용은 대리점에 문의하십시오.

- 과부하 보호 장치, 동축 보호용 칸막이 (DSISB50LNC2MA)
- PL259/미니-U 안테나 어댑터, 2.4m(8피트) 케이블 (HKN9557_)
- 마이크 걸이 클립(모든 마이크)(HLN9073_)
- 유니버설 마이크 걸이 클립(모든 마이크)(HLN9414_)
- IMPRES 모바일 MMP Non-PC 어댑터(PMKN4072_)
- IMPRES 모바일 MAP Non-PC 어댑터(PMKN4070_)
- 일반 옵션 보드(PMLN5718_S)
- 업무 수행용 무선 1선 보안업무용 키트 및 반투명 튜브 (PMLN7052_) ¹⁶
- 푸시 버튼 PTT(RLN5926_)
- 비상 쏫 스위치(RLN5929_)

스피커

- 13W 외장 스피커(RSN4002_)
- 7.5W 외장 스피커(RSN4003_)
- 5W 외장 스피커(RSN4004_)

¹⁶ 본 무전기는 여기에 나열된 액세서리와 호환됩니다. 자세한 내용은 대리점에 문의하십시오.

Daftar Isi

Informasi Keselamatan Penting.....	29	Menerima dan Menjawab Panggilan Grup WAVE.....	43
Versi Perangkat Lunak.....	30	Menerima dan Menjawab Panggilan Pribadi WAVE.....	44
Hak Cipta.....	31	Beralih dari Mode WAVE ke Mode Radio.....	44
Hak Cipta Perangkat Lunak Komputer.....	33	WAVE Tactical/5000.....	45
Langkah Pengamanan untuk Penanganan.....	34	Mengatur Saluran WAVE Aktif.....	45
Bab 1: Pengoperasian Dasar.....	36	Menampilkan Informasi Saluran WAVE..	45
Menyalakan Radio.....	36	Menampilkan Informasi Endpoint WAVE.....	46
Mematikan Radio.....	36	Mengubah Konfigurasi WAVE.....	46
Mengatur Volume.....	36	Melakukan Panggilan Grup WAVE.....	47
Bab 2: Kontrol Radio.....	38	Bagian I: Operasi Capacity Max.....	48
Kenop Volume/Saluran.....	38	Tombol Tekan untuk Berbicara (PTT).....	48
Mengatur Preferensi Operasi Kenop Ganda.....	39	Tombol yang Dapat Diprogram.....	48
Tombol Mikrofon Keypad.....	39	Fungsi Radio yang Dapat Ditetapkan.....	49
Bab 3: WAVE.....	42	Fungsi Utilitas atau Pengaturan yang Dapat Ditetapkan.....	51
WAVE OnCloud/OnPremise.....	42	Mengakses Fungsi Terprogram.....	52
Beralih dari Mode Radio ke Mode WAVE.....	42	Indikator Status.....	52
Melakukan Panggilan Grup WAVE.....	43	Ikon.....	53

Indikator LED.....	59	Melakukan Panggilan Grup Menggunakan Tombol Angka yang Dapat Diprogram	69
Nada.....	60	Melakukan Panggilan Grup Menggunakan Pencarian Alias ...	70
Nada Audio.....	60	Merespons Panggilan Grup.....	72
Nada Indikator.....	61	Panggilan Siaran.....	73
Registrasi.....	61	Melakukan Panggilan Siaran.....	74
Pemilihan Zona dan Saluran.....	62	Melakukan Panggilan Siaran Menggunakan Daftar Kontak.....	74
Memilih Zona.....	62	Melakukan Panggilan Siaran Menggunakan Tombol Angka yang Dapat Diprogram.....	75
Memilih Zona Menggunakan Pencarian Alias.....	63	Menerima Panggilan Siaran.....	75
Memilih Jenis Panggilan.....	63	Panggilan Pribadi.....	76
Memilih Site.....	64	Melakukan Panggilan Pribadi.....	76
Permintaan Jelajah.....	64	Melakukan Panggilan Pribadi Menggunakan Tombol Angka yang Dapat Diprogram	77
Kunci Site Aktif/Nonaktif.....	64	Melakukan Panggilan Pribadi Menggunakan Pencarian Alias ...	78
Batasan Site.....	65	Melakukan Panggilan Pribadi dengan Tombol Panggilan Satu Sentuhan.....	80
Trunking Site.....	65		
Panggilan.....	66		
Panggilan Grup.....	67		
Melakukan Panggilan Grup.....	67		
Melakukan Panggilan Grup Menggunakan Daftar Kontak.....	68		

Melakukan Panggilan Pribadi Menggunakan Panggilan Manual	81	Melakukan Panggilan Telepon Menggunakan Panggilan Manual.....	96
Menerima Panggilan Pribadi.....	82	Multi Frekuensi Dual Tone.....	99
Menerima Panggilan Pribadi.....	82	Memulai Panggilan DTMF.....	99
Menolak Panggilan Pribadi.....	83	Merespons Panggilan Telepon sebagai Semua Panggilan.....	99
Semua Panggilan.....	83	Merespons Panggilan Telepon sebagai Panggilan Grup.....	100
Melakukan Semua Panggilan.....	84	Merespons Panggilan Telepon sebagai Panggilan Pribadi.....	100
Melakukan Semua Panggilan Menggunakan Tombol Angka yang Dapat Diprogram	84	Penimpaan Panggilan.....	101
Melakukan Semua Panggilan Menggunakan Pencarian Alias....	85	Interupsi Suara.....	102
Menerima Semua Panggilan.....	87	Mengaktifkan Interupsi Suara....	102
Panggilan Telepon.....	88	Fitur Lanjutan.....	103
Melakukan Panggilan Telepon.....	88	Antrean Panggilan.....	103
Melakukan Panggilan Telepon dengan Tombol yang Dapat Diprogram 	89	Panggilan Prioritas.....	103
Melakukan Panggilan Telepon Menggunakan Daftar Kontak	91	Pemindaian Grup Bicara.....	104
Melakukan Panggilan Telepon Menggunakan Pencarian Alias....	94	Mengaktifkan atau Menonaktifkan Pemindaian Grup Bicara.....	105
		Daftar Grup Terima.....	105

Monitor Prioritas.....	106	Penguatan Mikrofon Bluetooth...	115
Mengedit Prioritas untuk Grup Bicara.....	107	Lokasi Dalam Ruangan.....	116
Afiliasi Multi Grup Bicara.....	107	Mengaktifkan atau Menonaktifkan Lokasi Dalam Ruangan.....	116
Menambahkan Afiliasi Grup Bicara.....	108	Mengakses Informasi Suar Lokasi Dalam Ruangan.....	118
Menghapus Afiliasi Grup Bicara.	109	Kontrol Multisite.....	118
Talkback.....	110	Memulai Pencarian Site Manual	118
Bluetooth.....	110	Kunci Site Aktif/Nonaktif.....	119
Mengaktifkan dan Menonaktifkan Bluetooth.....	111	Mengakses Daftar Site Tetangga.....	119
Menghubungkan ke Perangkat Bluetooth.....	112	Pengingat Saluran Rumah.....	119
Menghubungkan ke Perangkat Bluetooth dalam Mode Dapat Ditemukan.....	113	Mematikan Suara Pengingat Saluran Rumah.....	120
Memutuskan Sambungan dari Perangkat Bluetooth.....	113	Mengatur Saluran Rumah Baru.	120
Mengalihkan Rute Audio antara Speaker Radio Internal dan Perangkat Bluetooth.....	114	Monitor Jauh.....	121
Melihat Detail Perangkat.....	114	Menginisiasi Monitor Jauh.....	121
Menghapus Nama Perangkat....	115	Mengaktifkan Monitor Jauh Menggunakan Daftar Kontak	122
		Mengaktifkan Monitor Jauh Menggunakan Panggilan Manual.....	122

Pengaturan Kontak.....	123	untuk Status Telemetry dengan Teks.....	130
Mengalokasikan Entri ke Tombol Angka yang Dapat Diprogram.....	124	Menetapkan Gaya Dering.....	131
Menghapus Kaitan Antara Entri dan Tombol Angka yang Dapat Diprogram.....	125	Volume Nada Alarm yang Semakin Tinggi.....	131
Menambahkan Kontak Baru.....	126	Fitur Log Panggilan.....	132
Pengaturan Indikator Panggilan.....	127	Melihat Panggilan Terbaru.....	132
Mengaktifkan atau Menonaktifkan Dering Panggilan untuk Panggilan Pribadi.....	127	Menyimpan Alias atau ID dari Daftar Panggilan.....	132
Mengaktifkan atau Menonaktifkan Dering Panggilan untuk Pesan Teks.....	128	Menghapus Panggilan dari Daftar Panggilan.....	133
Mengaktifkan atau Menonaktifkan Dering Panggilan untuk Peringatan Panggilan.....	129	Menghapus Semua Panggilan dari Daftar Panggilan.....	134
Mengaktifkan atau Menonaktifkan Dering Panggilan untuk Panggilan Selektif.....	129	Melihat Detail dari Daftar Panggilan.....	135
Mengaktifkan atau Menonaktifkan Dering Panggilan		Operasi Peringatan Panggilan.....	135
		Melakukan Peringatan Panggilan.....	136
		Membuat Peringatan Panggilan Menggunakan Daftar Kontak.....	136
		Merespons Peringatan Panggilan.....	137
		Mode Bisu.....	138

Mengaktifkan Mode Bisu.....	138	Melihat Pesan Status.....	151
Menyetel Pewaktu Mode Bisu....	138	Menanggapi Pesan Status.....	151
Keluar dari Mode Bisu.....	139	Menghapus Pesan Status.....	152
Pengoperasian Darurat.....	139	Menghapus Semua Pesan Status.....	153
Mengirim Alarm Darurat.....	141	Pengolahan Pesan Teks.....	153
Mengirim Alarm Darurat dengan Panggilan.....	142	Pesan Teks.....	154
Mengirim Alarm Darurat dengan Panduan Suara.....	143	Melihat Pesan Teks.....	154
Menerima Alarm Darurat.....	145	Melihat Pesan Teks Status Telemetri.....	154
Merespons Alarm Darurat	146	Merespons Pesan Teks..	155
Merespons Alarm Darurat dengan Panggilan.....	147	Merespons Pesan Teks dengan Teks Cepat.....	156
Pesan Status.....	147	Mengirim Ulang Pesan Teks.....	157
Mengirim Pesan Status.....	148	Meneruskan Pesan Teks	157
Mengirim Pesan Status Menggunakan Tombol yang Dapat Diprogram.....	149	Meneruskan Pesan Teks Menggunakan Panggilan Manual.....	158
Mengirim Pesan Status Menggunakan Daftar Kontak.....	149	Mengedit Pesan Teks.....	159
Mengirim Pesan Status Menggunakan Panggilan Manual.....	150	Menulis Pesan Teks.....	160
		Mengirim Pesan Teks.....	160

Menghapus Pesan Teks dari Kotak Masuk.....	161	Pesan Teks Cepat	168
Menghapus Semua Pesan Teks dari Kotak Masuk.....	162	Mengirim Pesan Teks Cepat	168
Pesan Teks Terkirim.....	163	Konfigurasi Entri Teks.....	169
Melihat Pesan Teks Terkirim.....	163	Mengaktifkan atau Menonaktifkan Koreksi Kata.....	170
Mengirim Pesan Teks Terkirim.....	164	Mengaktifkan atau Menonaktifkan Prediksi Kata.....	170
Menghapus Pesan Teks Terkirim dari folder Item Terkirim.....	165	Kapitalisasi Kalimat.....	171
Menghapus Semua Pesan Teks Terkirim dari folder Item Terkirim.....	165	Melihat Kata Khusus.....	172
Pesan SMS Tersimpan.....	166	Mengedit Kata Khusus.....	173
Melihat Pesan Teks Tersimpan.....	166	Menambahkan Kata Khusus.....	174
Mengedit Pesan Teks Tersimpan.....	167	Menghapus Kata Khusus.....	175
Menghapus Pesan Teks Tersimpan dari Folder Konsep.....	167	Menghapus Semua Kata Khusus.....	176
		Tiket Tugas.....	176
		Mengakses Folder Tiket Tugas..	178
		Masuk atau Keluar dari Server Jauh.....	178
		Membuat Tiket Tugas.....	179
		Merespons Tiket Tugas.....	179

Mengirim Tiket Tugas		Mengaktifkan Radio	
Menggunakan Satu Template		Menggunakan Daftar Kontak.....	188
Tiket Tugas.....	180	Mengaktifkan Radio	
Mengirim Tiket Tugas		Menggunakan Panggilan	
Menggunakan Lebih Dari Satu		Manual.....	189
Template Tiket Tugas.....	181	Radio Kill.....	190
Menghapus Tiket Tugas.....	181	Pekerja Terpisah.....	190
Menghapus Semua Tiket Tugas	182	Fitur Kunci Kata Sandi.....	190
Privasi.....	183	Mengakses Radio	
Mengaktifkan atau		Menggunakan Kata Sandi.....	191
Menonaktifkan Privasi.....	184	Membuka Kunci Radio dalam	
Larangan Tanggapan.....	184	Status Terkunci.....	191
Menonaktifkan atau		Mengaktifkan atau	
Menonaktifkan Larangan		Menonaktifkan Kunci Kata Sandi	
Tanggapan.....	185	192
Stun/Revive.....	185	Mengganti Kata Sandi.....	193
Mengaktifkan Radio.....	185	Daftar Notifikasi.....	194
Menonaktifkan Sementara		Mengakses Daftar Notifikasi.....	194
Radio Menggunakan Daftar		Pemrograman Melalui Udara.....	194
Kontak.....	186	Memilih Mode Koneksi Periferal Pihak	
Menonaktifkan Radio		Ketiga.....	195
Menggunakan Panggilan		Indikator Kekuatan Sinyal Penerimaan.	196
Manual.....	187	Melihat Nilai RSSI.....	196
Mengaktifkan Radio.....	187		

Konfigurasi Panel Depan.....	196	Menghapus Titik Akses Jaringan	204
Masuk ke Mode Konfigurasi		
Panel Depan.....	196	Penetapan Nomor Grup Dinamis	
Mengedit Parameter Mode FPP		(DGNA).....	205
.....	197	Melakukan Panggilan DGNA.....	206
Pengoperasian Wi-Fi.....	197	Melakukan Panggilan Non-	
Mengaktifkan atau		DGNA.....	206
Menonaktifkan Wi-Fi.....	198	Menerima dan Menjawab	
Mengaktifkan atau		Panggilan DGNA.....	206
Menonaktifkan Wi-Fi dari Jarak		Utilitas.....	207
Jauh Menggunakan Radio		Tingkat Daya.....	207
Khusus (Kontrol Individu).....	198	Mengatur Tingkat Daya.....	207
Mengaktifkan atau		Mengaktifkan atau Menonaktifkan	
Menonaktifkan Wi-Fi dari Jarak		Nada/Peringatan Radio.....	208
Jauh Menggunakan Radio		Mengaktifkan atau Menonaktifkan	
Khusus (Kontrol Grup).....	199	Nada Keypad.....	209
Menghubungkan ke Titik Akses		Mengatur Tingkat Offset Volume Nada/	
Jaringan.....	200	Peringatan.....	209
Memeriksa Status Koneksi Wi-Fi		Mengaktifkan atau Menonaktifkan	
.....	201	Nada Izin Bicara.....	210
Menyegarkan Daftar Jaringan....	202	Mengaktifkan atau Menonaktifkan	
Menambahkan Jaringan.....	202	Nada Penyalaan.....	211
Melihat Detail Titik Akses			
Jaringan.....	203		

Mengatur Nada Peringatan Pesan Teks.....	211	Mengaktifkan atau Menonaktifkan AGC Mikrofon Digital.....	220
Mengubah Mode Layar.....	212	Mengaktifkan atau Menonaktifkan Audio Cerdas.....	221
Mengatur Kecerahan Layar.....	213	Mengaktifkan atau Menonaktifkan Fitur Peredam Umpan Balik Akustik.....	222
Mengaktifkan atau Menonaktifkan Klakson/Lampu.....	213	Mengaktifkan atau Menonaktifkan Peningkatan Trill.....	222
Mengaktifkan atau Menonaktifkan Indikator LED.....	214	Ambien Audio.....	223
Mengaktifkan atau Menonaktifkan Sistem Public Address.....	215	Mengatur Ambien Audio.....	223
Mengaktifkan atau Menonaktifkan Sistem Public Address Eksternal.....	215	Profil Audio.....	224
Mengaktifkan atau Menonaktifkan Layar Pengantar.....	216	Mengatur Profil Audio.....	224
Mengatur Bahasa.....	217	Mengaktifkan atau Menonaktifkan Global Navigation Satellite System.....	225
Mengidentifikasi Jenis Kabel.....	217	Informasi Umum Radio.....	226
Mengaktifkan atau Menonaktifkan Pengumuman Suara.....	218	Memeriksa Alias dan ID Radio...226	
Mengaktifkan atau Menonaktifkan Papan Opsi.....	218	Memeriksa Versi Firmware dan Codeplug.....	227
Teks ke Ucapan.....	218	Memeriksa Informasi Pembaruan Perangkat Lunak....	228
Mengatur Teks ke Ucapan.....	219	Memeriksa Informasi GNSS.....	228
Mengatur Pencatat Waktu Menu.....	219	Menampilkan Informasi Site.....	229

Melihat Detail Sertifikat Wi-Fi Enterprise.....	229	Beralih Antara Mode Connect Plus dan Non-Connect Plus.....	241
Bagian II: Pengoperasian Connect Plus.....	231	Melakukan dan Menerima Panggilan dalam Mode Connect Plus.....	241
Kontrol Radio Tambahan dalam Mode Connect Plus.....	231	Memilih Site.....	241
Tombol Tekan untuk Berbicara (Push-to-Talk/PTT).....	231	Permintaan Jelajah.....	242
Tombol yang Dapat Diprogram.....	231	Kunci Site Aktif/Nonaktif.....	242
Fungsi Radio yang Dapat Ditetapkan.....	232	Batasan Site.....	242
Fungsi Utilitas atau Pengaturan yang Dapat Ditetapkan.....	234	Memilih Zona.....	243
Mengidentifikasi Indikator Status dalam Mode Connect Plus.....	234	Menggunakan Beberapa Jaringan.....	244
Ikon Layar.....	234	Memilih Jenis Panggilan.....	244
Ikon Panggilan.....	237	Menerima dan Menjawab Panggilan Radio.....	244
Ikon Menu Lanjutan.....	238	Menerima dan Menjawab Panggilan Grup.....	245
Ikon Item Terkirim.....	238	Menerima dan Menjawab Panggilan Pribadi.....	245
Ikon Perangkat Bluetooth.....	239	Menerima Semua Panggilan Site.....	246
Indikator LED.....	239	Menerima Panggilan Telepon Pribadi Inbound.....	247
Nada Indikator.....	240	Melakukan Buffered Over-Dial dalam	
Nada Peringatan.....	241		

Panggilan Pribadi		Melakukan Panggilan dengan	
Telepon Inbound.....	247	Tombol Panggil Manual yang	
Melakukan Live Over-Dial		Dapat Diprogram.....	253
dalam Panggilan Pribadi		Melakukan Panggilan	
Telepon Inbound.....	248	Pribadi.....	253
Menerima Panggilan Telepon		Melakukan Panggilan Telepon	
Grup Bicara Inbound.....	249	Pribadi Outbound dengan	
Panggilan Telepon Multi-grup		Tombol Pemanggil Dapat	
Inbound.....	249	Diprogram.....	254
Melakukan Panggilan Radio.....	249	Melakukan Panggilan Telepon	
Melakukan Panggilan dengan		Pribadi Outbound melalui Menu	
Kenop Pemilih Saluran.....	249	Telepon.....	255
Melakukan Panggilan		Melakukan Panggilan Telepon	
Grup.....	250	Pribadi Outbound dari Kontak....	256
Melakukan Panggilan		Menunggu Alokasi Saluran	
Pribadi.....	250	dalam Panggilan Telepon	
Melakukan Semua		Pribadi Outbound.....	257
Panggilan Site.....	251	Melakukan Buffered Over-Dial	
Melakukan Panggilan		dalam Panggilan Telepon	
Multi-grup.....	252	Pribadi Outbound Terhubung....	257
Melakukan Panggilan Pribadi		Melakukan Live Over-Dial dalam	
dengan Tombol Panggilan Satu		Panggilan Telepon Pribadi	
Sentuhan.....	252	Outbound Terhubung.....	258
		Fitur Lanjutan dalam Mode Connect Plus.....	259

Pengingat Saluran Rumah.....	259	Menambahkan atau Menghapus Grup melalui Menu Tambah Anggota.....	269
Fallback Otomatis.....	259	Memahami Operasi Pemindaian.....	271
Indikasi Mode Fallback Otomatis	259	Pindai Talkback.....	271
Melakukan/Menerima Panggilan dalam Mode Fallback.....	260	Mengedit Prioritas untuk Grup Bicara... 272	
Kembali ke Pengoperasian Normal.....	261	Pengaturan Kontak.....	273
Pemeriksaan Radio.....	261	Melakukan Panggilan Pribadi dari Kontak.....	274
Mengirimkan Pemeriksaan Radio.....	261	Melakukan Pencarian Alias Panggilan.....	274
Monitor Jauh.....	263	Menambah Kontak Baru.....	275
Menginisiasi Monitor Jauh.....	263	Pengaturan Indikator Panggilan.....	275
Pemindaian.....	264	Mengaktifkan dan Menonaktifkan Dering Panggilan untuk Peringatan Panggilan.....	276
Memulai dan Menghentikan Pemindaian.....	265	Mengaktifkan dan Menonaktifkan Dering Panggilan untuk Panggilan Pribadi.....	276
Menjawab suatu Transmisi Selama Pemindaian.....	265	Mengaktifkan dan Menonaktifkan Dering Panggilan untuk Pesan Teks.....	277
Pemindaian yang Dapat Dikonfigurasi oleh Pengguna.....	266	Memilih Jenis Tanda Dering.....	278
Mengaktifkan atau Menonaktifkan Pemindaian.....	266		
Mengedit Daftar Pindai.....	267		

Volume Nada Alarm yang Semakin Tinggi.....	278	Menyimpan Detail Darurat ke Daftar Alarm.....	287
Log Panggilan.....	278	Menghapus Detail Darurat.....	287
Melihat Panggilan Terbaru.....	279	Merespons Panggilan Darurat... 288	
Menghapus Panggilan dari Daftar Panggilan.....	279	Merespons Peringatan Darurat..288	
Melihat Detail dari Log Panggilan.....	280	Mengabaikan Panggilan Balik Darurat.....	289
Operasi Peringatan Panggilan.....	280	Memulai Panggilan Darurat.....	289
Merespons Peringatan Panggilan.....	280	Memulai Panggilan Darurat dengan Suara untuk Diikuti.....	290
Membuat Peringatan Panggilan dari Daftar Kontak.....	281	Memulai Peringatan Darurat.....	290
Membuat Peringatan Panggilan dengan Tombol Akses Satu Sentuhan.....	282	Keluar dari Mode Darurat.....	291
Mode Bisu.....	282	Pengolahan Pesan Teks.....	291
Mengaktifkan Mode Bisu.....	283	Mengirimkan Pesan Teks Cepat	292
Menyetel Pewaktu Mode Bisu....	283	Mengirimkan Pesan Teks Cepat dengan Tombol Akses Satu Sentuhan.....	292
Keluar dari Mode Bisu.....	284	Mengakses Folder Konsep.....	293
Pengoperasian Darurat.....	285	Melihat Pesan Teks yang Disimpan.....	293
Menerima Darurat Masuk.....	286	Mengedit dan Mengirim Pesan Teks yang Disimpan.....	294

Menghapus Pesan Teks yang Disimpan dari Konsep.....	295	Menghapus Pesan Teks dari Kotak Masuk.....	302
Mengelola Pesan Teks yang Gagal Terkirim.....	295	Menghapus Semua Pesan Teks dari Kotak Masuk.....	303
Mengirim Ulang Pesan Teks.....	296	Privasi.....	304
Meneruskan Pesan Teks	296	Melakukan Panggilan dengan Privasi Diaktifkan (Acak).....	305
Mengelola Pesan Teks Terkirim	296	Dukungan.....	306
Melihat Pesan Teks Terkirim.....	297	Penonaktifan Radio.....	306
Mengirimkan Pesan Teks Terkirim.....	297	Pengaktifan Radio.....	308
Menghapus Semua Pesan Teks Terkirim dari Item Terkirim.....	299	Pengoperasian Bluetooth.....	310
Menerima Pesan Teks.....	300	Mengaktifkan dan Menonaktifkan Bluetooth.....	310
Membaca Pesan Teks.....	300	Mencari dan Menyambung ke Perangkat Bluetooth.....	311
Mengelola Pesan Teks yang Diterima.....	300	Mencari dan Menyambung dari Perangkat Bluetooth (Mode Dapat Ditemukan).....	312
Melihat Pesan Teks dari Kotak Masuk.....	301	Memutuskan Sambungan dari Perangkat Bluetooth.....	313
Membalas Pesan Teks dari Kotak Masuk.....	301	Mengalihkan Rute Audio antara Speaker Radio Internal dan Perangkat Bluetooth.....	314

Melihat Detail Perangkat.....	314	Menghubungkan ke Titik Akses Jaringan.....	321
Menghapus Nama Perangkat....	314	Memeriksa Status Koneksi Wi-Fi	322
Penguatan Mikrofon Bluetooth... 315		Menyegarkan Daftar Jaringan....	323
Lokasi Dalam Ruangan.....	315	Menambahkan Jaringan.....	324
Mengaktifkan atau Menonaktifkan Lokasi Dalam Ruangan.....	316	Melihat Detail Titik Akses Jaringan.....	324
Mengakses Informasi Suar Lokasi Dalam Ruangan.....	317	Menghapus Titik Akses Jaringan	325
Daftar Notifikasi.....	318	Utilitas.....	326
Mengakses Daftar Pemberitahuan.....	318	Mengaktifkan atau Menonaktifkan Nada/Peringatan Radio.....	326
Pengoperasian Wi-Fi.....	318	Mengatur Tingkat Offset Volume Peringatan Nada.....	327
Mengaktifkan atau Menonaktifkan Wi-Fi.....	319	Mengaktifkan atau Menonaktifkan Nada Izin Bicara	328
Mengaktifkan atau Menonaktifkan Wi-Fi dari Jarak Jauh Menggunakan Radio Khusus (Kontrol Individu).....	320	Mengaktifkan atau Menonaktifkan Nada Tanda Hidup Radio.....	329
Mengaktifkan atau Menonaktifkan Wi-Fi dari Jarak Jauh Menggunakan Radio Khusus (Kontrol Grup).....	321	Mengatur Tingkat Daya.....	329
		Mengubah Mode Tampilan.....	330

Menyesuaikan Kecerahan Layar	331	Memeriksa Indeks Nomor Model Radio.....	341
Mengaktifkan atau Menonaktifkan Layar Pengantar Bahasa.....	331 332	Memeriksa CRC File Codeplug OTA Papan Opsi.....	341 341
Mengaktifkan atau Menonaktifkan Indikator LED.....	333	Menampilkan ID Site (Nomor Site).....	342
Mengidentifikasi Jenis Kabel.....	333	Memeriksa Info Site.....	342
Pengumuman Suara.....	334	Memeriksa ID Radio.....	343
Pencatat Waktu Menu.....	334	Memeriksa Versi Firmware dan Versi Codeplug.....	344 344
Mengaktifkan atau Menonaktifkan Klakson/Lampu..	335	Memeriksa Pembaruan... Melihat Detail Sertifikat Wi-Fi Enterprise.....	344 353
Mengatur Preferensi Operasi Kenop Ganda.....	336	Bagian III: Sistem Lainnya.....	354
Mik Digital AGC (Mic AGC-D)....	336	Tombol Push-To-Talk.....	354
Audio Cerdas.....	337	Tombol yang Dapat Diprogram.....	354
Mengaktifkan atau Menonaktifkan Fitur Peredam Umpan Balik Akustik.....	339	Fungsi Radio yang Dapat Ditetapkan...	355
Mengaktifkan atau Menonaktifkan GNSS.....	339	Fungsi Utilitas atau Pengaturan yang Dapat Ditetapkan.....	358
Mengakses Informasi Radio Umum.....	340	Mengakses Fungsi Terprogram.....	358
		Indikator Status.....	359

Ikon.....	359	Melakukan Panggilan Grup Menggunakan Tombol Angka yang Dapat Diprogram  	375
Indikator LED.....	366	Merespons Panggilan Grup.....	376
Nada.....	367	Panggilan Pribadi 	377
Nada Indikator.....	367	Melakukan Panggilan Pribadi 	377
Nada Audio.....	367	Melakukan Panggilan Pribadi Menggunakan Daftar Kontak  .	378
Mode Analog Konvensional dan Digital.....	368	Melakukan Panggilan Pribadi Menggunakan Panggilan Manual 	379
Informasi tentang Ikon.....	368	Melakukan Panggilan Pribadi Menggunakan Tombol Angka yang Dapat Diprogram  	380
IP Site Connect 	369	Merespons Panggilan Pribadi 	381
Capacity Plus–Single-Site 	369	Semua Panggilan.....	381
Capacity Plus–Multi-Site 	370	Menerima Semua Panggilan.....	382
Pemilihan Zona dan Saluran.....	371	Melakukan Semua Panggilan Menggunakan Tombol Angka yang Dapat Diprogram 	383
Memilih Zona.....	371		
Memilih Zona Menggunakan Pencarian Alias.....	371		
Memilih Saluran.....	372		
Panggilan.....	372		
Panggilan Grup.....	374		
Melakukan Panggilan Grup.....	374		
Melakukan Panggilan Grup Menggunakan Daftar Kontak.....	374		

Panggilan Selektif 📞	384	Merespons Panggilan Telepon sebagai Panggilan Pribadi 📞	396
Melakukan Panggilan Selektif....	384	Menghentikan Panggilan Radio 📞	397
Merespons Panggilan Selektif 📞	384	Talkaround.....	397
Panggilan Telepon 📞	385	Beralih Antara Mode Repeater dan Talkaround.....	397
Melakukan Panggilan Telepon 📞	386	Panggilan Suara Siaran.....	398
Melakukan Panggilan Telepon Menggunakan Daftar Kontak 📞	387	Melakukan Panggilan Suara Siaran.....	398
Melakukan Panggilan Telepon Menggunakan Panggilan Manual 📞	389	Melakukan Panggilan Suara Siaran Menggunakan Tombol Angka yang Dapat Diprogram 📞	399
Melakukan Panggilan Grup, Pribadi, Telepon, atau Semua Panggilan Menggunakan Pencarian Alias 📞 📞	392	Melakukan Panggilan Suara Siaran Menggunakan Pencarian Alias 📞	399
Multi Frekuensi Dual Tone.....	394	Menerima Panggilan Suara Siaran.....	401
Memulai Panggilan DTMF.....	394	Panggilan Tidak Dialamatkan.....	402
Merespons Panggilan Telepon sebagai Panggilan Grup 📞	394	Melakukan Panggilan Tidak Dialamatkan.....	402
Merespons Panggilan Telepon sebagai Semua Panggilan 📞	395	Merespons Panggilan Tidak Dialamatkan.....	403

Mode Saluran Suara Terbuka (OVCM) 404	Melihat Entri dalam Daftar Pindai..... 413
Melakukan Panggilan OVCM.... 404	Melihat Entri dalam Daftar Pindai Menggunakan Pencarian Alias 413
Merespons Panggilan OVCM.... 404	Menambahkan Entri Baru ke Daftar Pindai..... 414
Fitur Lanjutan.....405	Menambahkan Entri Baru ke Daftar Pindai Menggunakan Pencarian Alias 📞 415
Peringat Saluran Rumah.....405	Menghapus Entri dari Daftar Pindai..... 416
Mematikan Suara Peringat Saluran Rumah..... 406	Menetapkan Prioritas untuk Entri dalam Daftar Pindai..... 417
Mengatur Saluran Rumah Baru. 406	Pemindaian..... 417
Pemeriksaan Radio 📻 407	Mengaktifkan atau Menonaktifkan Pemindaian.....418
Mengirim Pemeriksaan Radio 📻 407	Merespons Transmisi Selama Pemindaian..... 419
Mengirim Pemeriksaan Radio Menggunakan Panggilan Manual 📻 408	Menghapus Saluran Gangguan. 419
Monitor Jarak Jauh..... 409	Memulihkan Saluran Gangguan 420
Menginisiasi Monitor Jauh..... 409	Vote Scan 📞 420
Mengaktifkan Monitor Jauh Menggunakan Daftar Kontak 410	Pengaturan Kontak..... 420
Memulai Monitor Jauh Menggunakan Panggilan Manual 📞 411	
Daftar Pindai..... 412	

Melakukan Panggilan Grup Menggunakan Daftar Kontak.....	421	Mengaktifkan atau Menonaktifkan Dering Panggilan untuk Pesan Teks 	428
Melakukan Panggilan Pribadi Menggunakan Daftar Kontak 	422	Mengaktifkan atau Menonaktifkan Dering Panggilan untuk Status Telemetry dengan Teks.....	429
Mengalokasikan Entri ke Tombol Angka yang Dapat Diprogram 	423	Menetapkan Gaya Dering.....	430
Menghapus Kaitan Antara Entri dan Tombol Angka yang Dapat Diprogram 	424	Volume Nada Alarm yang Semakin Tinggi.....	430
Menambahkan Kontak Baru.....	425	Fitur Log Panggilan.....	431
Mengatur Kontak Default 	425	Melihat Panggilan Terbaru.....	431
Pengaturan Indikator Panggilan.....	426	Menghapus Panggilan dari Daftar Panggilan 	431
Mengaktifkan atau Menonaktifkan Dering Panggilan untuk Peringatan Panggilan.....	426	Menampilkan Detail Daftar Panggilan 	432
Mengaktifkan atau Menonaktifkan Dering Panggilan untuk Panggilan Pribadi 	427	Menyimpan Alias atau ID dari Daftar Panggilan 	433
Mengaktifkan atau Menonaktifkan Dering Panggilan untuk Panggilan Selektif 	428	Operasi Peringatan Panggilan.....	433
		Melakukan Peringatan Panggilan.....	434
		Membuat Peringatan Panggilan Menggunakan Daftar Kontak.....	434

Membuat Peringatan Panggilan		Mengaktifkan Ulang Mode	
Menggunakan Panggilan		Darurat.....	445
Manual.....	435	Keluar Mode Darurat Setelah	
Merespons Peringatan		Mengirim Alarm Darurat.....	445
Panggilan.....	436	Menghapus Item Alarm dari	
Mode Bisu.....	436	Daftar Alarm.....	445
Mengaktifkan Mode Bisu.....	436	Pengolahan Pesan Teks.....	446
Menyetel Pewaktu Mode Bisu....	437	Pesan Teks 	446
Keluar dari Mode Bisu.....	437	Melihat Pesan Teks.....	446
Pengoperasian Darurat.....	438	Melihat Pesan Teks	
Menerima Alarm Darurat.....	439	Status Telemetri.....	447
Merespons Alarm Darurat.....	440	Merespons Pesan Teks	
Keluar dari Mode Darurat			447
Setelah Menerima Alarm		Merespons Pesan Teks	
Darurat.....	441	dengan Balasan 	448
Mengirim Alarm Darurat.....	441	Mengirim Ulang Pesan	
Mengirim Alarm Darurat dengan		Teks.....	449
Panggilan.....	442	Meneruskan Pesan Teks	
Alarm Darurat dengan Suara			450
untuk Diikuti.....	443	Meneruskan Pesan Teks	
Mengirim Alarm Darurat dengan		Menggunakan Panggilan	
Panduan Suara 	444	Manual 	450
		Mengedit Pesan Teks.....	451

Menulis Pesan Teks.....	452	Menghapus Pesan Teks Tersimpan dari Folder Konsep.....	460
Mengirim Pesan Teks.....	453	Pesan Teks Cepat 	460
Menghapus Pesan Teks dari Kotak Masuk.....	454	Mengirim Pesan Teks Cepat 	460
Menghapus Semua Pesan Teks dari Kotak Masuk 	454	Konfigurasi Entri Teks.....	461
Pesan Teks Terkirim 	455	Mengaktifkan atau Menonaktifkan Koreksi Kata.....	462
Melihat Pesan Teks Terkirim 	456	Mengaktifkan atau Menonaktifkan Prediksi Kata.....	463
Mengirim Pesan Teks Terkirim 	456	Kapitalisasi Kalimat.....	463
Menghapus Pesan Teks Terkirim dari folder Item Terkirim 	457	Melihat Kata Khusus.....	464
Menghapus Semua Pesan Teks Terkirim dari folder Item Terkirim.....	457	Mengedit Kata Khusus.....	465
Pesan SMS Tersimpan.....	458	Menambahkan Kata Khusus.....	466
Melihat Pesan Teks Tersimpan.....	458	Menghapus Kata Khusus.....	467
Mengedit Pesan Teks Tersimpan.....	459	Menghapus Semua Kata Khusus.....	468
		Tiket Tugas.....	468
		Mengakses Folder Tiket Tugas..	470
		Masuk atau Keluar dari Server Jauh.....	470
		Membuat Tiket Tugas.....	471

Merespons Tiket Tugas.....	471	Menonaktifkan Radio	
Mengirim Tiket Tugas		Menggunakan Daftar Kontak	480
Menggunakan Satu Template		Menonaktifkan Radio	
Tiket Tugas.....	472	Menggunakan Panggilan	
Mengirim Tiket Tugas		Manual	481
Menggunakan Lebih Dari Satu		Mengaktifkan Radio	482
Template Tiket Tugas.....	473	Mengaktifkan Radio	
Menghapus Tiket Tugas.....	473	Menggunakan Daftar Kontak	483
Menghapus Semua Tiket Tugas	474	Mengaktifkan Radio	
Privasi	475	Menggunakan Panggilan	
Mengaktifkan atau		Manual	484
Menonaktifkan Privasi	476	Pekerja Terpisah.....	485
Larangan Tanggapan.....	476	Bluetooth.....	485
Menonaktifkan atau		Mengaktifkan dan	
Menonaktifkan Larangan		Menonaktifkan Bluetooth.....	486
Tanggapan.....	477	Menghubungkan ke Perangkat	
Kontrol Multisite.....	477	Bluetooth.....	487
Memulai Pencarian Site Manual	477	Menghubungkan ke Perangkat	
Kunci Site Aktif/Nonaktif.....	478	Bluetooth dalam Mode Dapat	
Mengakses Daftar Site		Ditemukan.....	488
Tetangga.....	478	Memutuskan Sambungan dari	
Keamanan	478	Perangkat Bluetooth.....	488
Menonaktifkan Radio	479		

Mengalihkan Rute Audio antara Speaker Radio Internal dan Perangkat Bluetooth.....	489	Indikator Kekuatan Sinyal Penerimaan.....	497
Melihat Detail Perangkat.....	490	Melihat Nilai RSSI.....	497
Menghapus Nama Perangkat....	490	Fitur Kunci Kata Sandi.....	498
Penguatan Mikrofon Bluetooth...491		Mengakses Radio	
Lokasi Dalam Ruangan.....	491	Menggunakan Kata Sandi.....	498
Mengaktifkan atau Menonaktifkan Lokasi Dalam Ruangan.....	492	Membuka Kunci Radio dalam Status Terkunci.....	499
Mengakses Informasi Suar Lokasi Dalam Ruangan.....	493	Mengaktifkan atau Menonaktifkan Kunci Kata Sandi	499
Daftar Notifikasi.....	494	Mengganti Kata Sandi.....	500
Mengakses Daftar Notifikasi.....	494	Konfigurasi Panel Depan.....	501
Sistem Transponder Auto-Range 	494	Masuk ke Mode Konfigurasi Panel Depan.....	501
Pemrograman Melalui Udara 	495	Mengedit Parameter Mode FPP	501
Penghambat Transmisi.....	496	Pengoperasian Wi-Fi.....	502
Mengaktifkan Penghambat Transmisi.....	496	Mengaktifkan atau Menonaktifkan Wi-Fi.....	502
Menonaktifkan Penghambat Transmisi.....	496	Mengaktifkan atau Menonaktifkan Wi-Fi dari Jarak Jauh Menggunakan Radio Khusus (Kontrol Individu).....	503
Memilih Mode Koneksi Periferal Pihak Ketiga.....	496		

Mengaktifkan atau Menonaktifkan Wi-Fi dari Jarak Jauh Menggunakan Radio Khusus (Kontrol Grup).....	504	Mengatur Tingkat Offset Volume Nada/ Peringatan.....	513
Menghubungkan ke Titik Akses Jaringan.....	505	Mengaktifkan atau Menonaktifkan Nada Izin Bicara.....	514
Memeriksa Status Koneksi Wi-Fi	506	Mengaktifkan atau Menonaktifkan Nada Penyalaan.....	514
Menyegarkan Daftar Jaringan....	506	Mengatur Nada Peringatan Pesan Teks.....	515
Menambahkan Jaringan.....	507	Mengubah Mode Layar.....	516
Melihat Detail Titik Akses Jaringan.....	508	Mengatur Kecerahan Layar.....	516
Menghapus Titik Akses Jaringan	509	Mengaktifkan atau Menonaktifkan Klakson/Lampu.....	517
Utilitas.....	509	Mengaktifkan atau Menonaktifkan Indikator LED.....	518
Tingkat Redaman.....	509	Mengaktifkan atau Menonaktifkan Sistem Public Address.....	518
Mengatur Tingkat Redaman.....	510	Mengaktifkan atau Menonaktifkan Sistem Public Address Eksternal.....	519
Tingkat Daya.....	510	Mengaktifkan atau Menonaktifkan Layar Pengantar.....	520
Mengatur Tingkat Daya.....	511	Mengatur Bahasa.....	520
Mengaktifkan atau Menonaktifkan Nada/Peringatan Radio.....	511	Mengidentifikasi Jenis Kabel.....	521
Mengaktifkan atau Menonaktifkan Nada Keypad.....	512	Transmisi Pengoperasian Suara.....	521

Mengaktifkan atau Menonaktifkan Transmisi Pengoperasian Suara.....	522	Mengatur Ambien Audio.....	529
Mengaktifkan atau Menonaktifkan Pengumuman Suara.....	523	Profil Audio.....	530
Mengaktifkan atau Menonaktifkan Papan Opsi.....	523	Mengatur Profil Audio.....	530
Teks ke Ucapan.....	523	Mengaktifkan atau Menonaktifkan Global Navigation Satellite System.....	531
Mengatur Teks ke Ucapan.....	523	Daftar Terima Fleksibel 	532
Mengaktifkan atau Menonaktifkan Penerusan Panggilan Otomatis.....	524	Mengaktifkan atau Menonaktifkan Daftar Terima Fleksibel.....	532
Mengatur Pencatat Waktu Menu.....	525	Informasi Umum Radio.....	533
Mengaktifkan atau Menonaktifkan AGC Mikrofon Analog.....	525	Memeriksa Alias dan ID Radio... 533	
Mengaktifkan atau Menonaktifkan AGC Mikrofon Digital.....	526	Memeriksa Versi Firmware dan Codeplug.....	534
Mengaktifkan atau Menonaktifkan Audio Cerdas.....	527	Memeriksa Informasi Pembaruan Perangkat Lunak....	534
Mengaktifkan atau Menonaktifkan Fitur Peredam Umpan Balik Akustik.....	528	Memeriksa Informasi GNSS.....	535
Mengaktifkan atau Menonaktifkan Peningkatan Trill.....	528	Menampilkan Informasi Site.....	535
Ambien Audio.....	529	Melihat Detail Sertifikat Wi-Fi Enterprise.....	536
		Bagian IV: Daftar Aksesori Resmi.....	537

Informasi Keselamatan Penting

Peralatan telekomunikasi ini sesuai dengan persyaratan dari Komisi Telekomunikasi Nasional.

Panduan Paparan Energi RF dan Keselamatan Produk untuk Radio Dua Arah Portabel

PERHATIAN!

Radio ini dibatasi hanya untuk penggunaan di lokasi kerja. Sebelum menggunakan radio, bacalah Panduan Paparan Energi RF dan Keselamatan Produk untuk Radio Dua Arah Mobile yang berisi petunjuk pengoperasian penting terkait penggunaan yang aman dan kesadaran akan energi RF, serta kontrol Kepatuhan terhadap standar dan Regulasi yang berlaku.

Untuk melihat daftar antena dan aksesoris lain yang telah disetujui penggunaannya oleh Motorola Solutions, kunjungi situs Web berikut:

<http://www.motorolasolutions.com>

Untuk model yang tersedia di Thailand:

อุปกรณ์โทรคมนาคมนี้ได้ปฏิบัติตามข้อกำหนดของคณะกรรมการกิจการโทรคมนาคมแห่งชาติ

Versi Perangkat Lunak

Semua fitur yang diuraikan di bagian berikut didukung oleh perangkat lunak versi **R02.10.00.0000** atau yang lebih baru.

Lihat [Memeriksa Versi Firmware dan Codeplug di halaman 227](#) untuk menentukan versi perangkat lunak radio Anda.

Tanyakan kepada penyalur atau administrator sistem Anda untuk informasi lebih lanjut.

Hak Cipta

Produk Motorola Solutions yang dijelaskan dalam dokumen ini mungkin mencakup program komputer Motorola Solutions berhak cipta. Undang-undang di Amerika Serikat dan negara lain yang termasuk dalam cakupan Motorola Solutions memiliki hak eksklusif atas program komputer berhak cipta. Oleh karena itu, semua program komputer Motorola Solutions berhak cipta yang terdapat dalam produk Motorola Solutions yang diuraikan dalam manual ini dilarang disalin atau diperbanyak dengan cara apa pun tanpa persetujuan tertulis yang jelas dari Motorola Solutions.

© 2019 Motorola Solutions, Inc. Hak Cipta Dilindungi Undang-Undang

Semua atau sebagian dokumen ini dilarang diperbanyak, dikirim, disimpan dalam sistem pemulihan, atau diterjemahkan ke dalam bahasa atau bahasa komputer tertentu, dengan bentuk atau cara apa pun, tanpa persetujuan tertulis yang jelas dari Motorola Solutions, Inc.

Selanjutnya, pembelian produk Motorola Solutions tidak boleh dianggap sebagai memberikan, baik secara langsung atau secara implisit, estoppel, atau cara lainnya, lisensi apa pun berdasarkan hak cipta, hak paten atau penerapan hak paten Motorola Solutions, kecuali untuk

lisensi noneksklusif dan bebas royalti normal untuk penggunaan yang timbul berdasarkan hukum penjualan produk.

Sangkalan

Perlu diperhatikan bahwa beberapa fitur, fasilitas, dan kemampuan yang dijelaskan dalam dokumen ini mungkin tidak berlaku atau berlisensi untuk penggunaan pada sistem khusus, atau mungkin tergantung pada karakteristik unit subscriber atau konfigurasi parameter khusus. Harap hubungi kontak Motorola Solutions untuk informasi lebih lanjut.

Merek dagang

MOTOROLA, MOTO, MOTOROLA SOLUTIONS, dan logo Stylized M merupakan merek dagang atau merek dagang terdaftar dari Motorola Trademark Holdings, LLC dan digunakan dengan lisensi. Semua merek dagang lain adalah properti dari pemiliknya masing-masing.

Pedoman Limbah Peralatan Listrik dan Elektronik (WEEE) Uni Eropa (UE)



■ Pedoman WEEE Uni Eropa mewajibkan produk yang dijual di negara UE untuk memiliki label keranjang sampah disilang pada produk (atau kemasan pada kasus tertentu).

Seperti yang dijelaskan dalam pedoman WEEE, label keranjang sampah disilang berarti pelanggan dan pengguna akhir di negara UE tidak boleh membuang barang elektronik dan perlengkapan atau aksesori elektronik ke dalam kategori limbah rumah tangga.

Pelanggan atau pengguna akhir di negara UE harus menghubungi perwakilan pemasok perlengkapan atau pusat layanan setempat untuk informasi mengenai sistem pengumpulan limbah di negara tersebut.

Hak Cipta Perangkat Lunak Komputer

Produk Motorola Solutions yang diuraikan dalam manual ini mungkin mencakup program komputer Motorola Solutions berhak cipta yang disimpan di dalam memori semikonduktor atau media lainnya. Undang-undang di Amerika Serikat dan negara-negara lainnya melindungi hak-hak eksklusif tertentu Motorola Solutions bagi program-program komputer berhak cipta yang meliputi, tetapi tidak terbatas pada, hak eksklusif untuk menyalin dan memperbanyak dalam segala bentuk program komputer berhak cipta tersebut. Oleh karena itu, semua program komputer Motorola Solutions berhak cipta yang terdapat dalam produk Motorola Solutions yang diuraikan dalam manual ini dilarang disalin, diperbanyak, dimodifikasi, direkayasa-balik, atau disebarluaskan dengan cara apa pun tanpa persetujuan tertulis yang jelas dari Motorola Solutions. Selanjutnya, pembelian produk Motorola Solutions tidak boleh dianggap sebagai memberikan, baik secara langsung atau secara implisit, estoppel, atau cara lainnya, lisensi apa pun berdasarkan hak cipta, hak paten atau penerapan hak paten Motorola Solutions, kecuali untuk lisensi noneksklusif normal untuk penggunaan yang timbul berdasarkan hukum penjualan produk.

Teknologi pengodean suara AMBE+2™ yang digabungkan dalam produk ini dilindungi oleh hak kekayaan intelektual termasuk hak paten, hak cipta, dan rahasia dagang Digital Voice Systems, Inc.

Teknologi pengodean suara ini hanya dilisensikan untuk penggunaan dalam Peralatan Komunikasi ini. Pengguna Teknologi ini secara tegas dilarang untuk mencoba mendekompilasi, merekayasa balik, atau membongkar Kode Objek, atau dengan cara lain apa pun mengonversi Kode Objek ini menjadi bentuk yang dapat dibaca manusia.

No. Pat. AS #5,870,405, #5,826,222, #5,754,974, #5,701,390, #5,715,365, #5,649,050, #5,630,011, #5,581,656, #5,517,511, #5,491,772, #5,247,579, #5,226,084 dan #5,195,166.

Langkah Pengamanan untuk Penanganan

Radio Portabel Digital Seri MOTOTRBO memenuhi spesifikasi IP67, yang memungkinkan radio Anda tahan terhadap kondisi lapangan yang buruk, seperti terbenam di dalam air. Bagian ini akan menguraikan beberapa langkah pengamanan untuk penanganan dasar.



PERHATIAN:

Jangan membongkar radio Anda. Ini dapat merusak segel radio dan mengakibatkan alur kebocoran menuju radio. Perawatan radio hanya boleh dilakukan di depot layanan yang mempunyai perlengkapan untuk menguji dan mengganti segel pada radio.

- Jika radio Anda sudah terendam di dalam air, goyang-goyangkan radio untuk membuang air yang mungkin terperangkap di dalam kisi speaker dan port mikrofon. Air yang terperangkap dapat menyebabkan kinerja audio menurun.
- Jika area kontak baterai sudah terpapar air, bersihkan dan keringkan kontak baterai baik pada radio Anda maupun baterai sebelum memasang baterai ke radio.

Sisa air bisa menyebabkan hubungan pendek pada radio.

- Jika radio Anda sudah terendam di dalam bahan yang bersifat korosif (misalnya air laut), bilas radio dan baterai dengan air bersih, kemudian keringkan radio serta baterainya.
- Untuk membersihkan permukaan luar radio Anda, gunakan larutan cair detergen pencuci piring ringan dan air tawar (contohnya, satu sendok teh detergen dengan satu galon air).
- Jangan sekali-kali menusuk ventilasi (lubang) yang ada pada sasis radio di bawah kontak baterai. Ventilasi ini memungkinkan penyetaraan tekanan di dalam radio. Jika ditusuk dapat menimbulkan kebocoran pada jalur ke dalam radio Anda dan daya tahan rendam radio bisa hilang.
- Jangan sekali-kali menghalangi atau menutupi ventilasi, meskipun dengan label.
- Pastikan bahwa tidak ada bahan berminyak yang mengenai ventilasi.
- Radio Anda yang dipasang antena dengan benar dirancang untuk bisa terendam hingga kedalaman maksimum 1 m (3,28 kaki) dan waktu perendaman maksimal 30 menit. Apabila melebihi batas maksimum

atau digunakan tanpa antena maka akan dapat menyebabkan kerusakan pada radio Anda.

- Sewaktu membersihkan radio Anda, jangan gunakan semprotan jet bertekanan tinggi ke radio karena ini akan melampaui tekanan kedalaman 1 m dan dapat menyebabkan air merembes ke dalam radio.

Pengoperasian Dasar

Bab ini menjelaskan pengoperasian yang membuat Anda dapat mulai menggunakan radio.

Menyalakan Radio

Ikuti prosedur untuk menyalakan radio.

Tekan tombol **On/Off**.

Jika berhasil:

- Nada akan berbunyi.
- LED hijau akan menyala.
- Layar menampilkan **MOTOTRBO <TM>**, diikuti pesan atau gambar selamat datang.
- Layar Awal menyala.

Jika fungsi Nada/Peringatan nonaktif, nada tidak berbunyi setelah menghidupkan.

Periksa baterai jika radio tidak dapat menyala. Pastikan bahwa baterai diisi dan dipasang dengan benar. Hubungi penyalur jika radio masih tidak dapat menyala.

Mematikan Radio

Ikuti prosedur untuk mematikan radio.

Tekan dan tahan tombol **On/Off**.

Radio mungkin memerlukan waktu hingga tujuh detik untuk mati sepenuhnya.

Layar menampilkan **Mematikan**.

Mengatur Volume

Ikuti prosedur untuk mengubah tingkat volume radio.

Lakukan salah satu langkah berikut:

- Putar **Kenop On/Off/Kontrol Volume** searah jarum jam untuk meningkatkan volume.
- Putar **Kenop On/Off/Kontrol Volume** berlawanan arah jarum jam untuk menurunkan volume.

**PEMBERITAHUAN:**

Radio Anda dapat diprogram pada offset volume suara minimum dengan tingkat volume suara tidak dapat dikurangi melebihi volume suara minimum yang diprogram. Tanyakan kepada penyalur atau administrator sistem Anda untuk informasi lebih lanjut.

Kontrol Radio

Bab ini menjelaskan tombol dan fungsi untuk mengontrol radio.

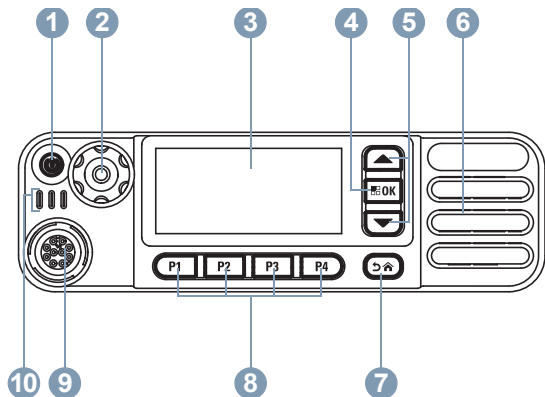

- 1 Tombol On/Off/Informasi
- 2 Kenop Volume/Saluran
- 3 Angka
- 4 Tombol Menu/OK
- 5 Tombol Gulir Atas/Bawah
- 6 Speaker



- 7 Tombol Kembali/Awal
- 8 Tombol Depan yang Dapat Diprogram
- 9 Konektor Aksesori
- 10 Indikator LED

Kenop Volume/Saluran

Kenop Volume/Saluran dapat diprogram untuk volume ganda dan kontrol saluran, atau hanya untuk kontrol volume.

Untuk menyesuaikan volume, lihat [Mengatur Volume di halaman 36](#).



Untuk mengubah saluran, tekan dan tahan **Kenop Volume/Saluran** hingga status pemilihan saluran ditampilkan. Putar **Kenop Volume/Saluran** untuk memilih saluran. Lakukan salah satu hal berikut untuk keluar dari status pemilihan saluran:



- Tekan **Kenop Volume/Saluran**.
- Tekan .
- Tekan .
- Tunggu hingga waktu pewaktu menu habis.

Mengatur Preferensi Operasi Kenop Ganda

Ikuti prosedur untuk mengatur nada preferensi operasi kenop ganda radio.



- 1 Tekan  untuk mengakses menu.



- 2 Tekan  atau  ke Utilitas. Tekan  untuk memilih.

- 3 Tekan  atau  ke Pengaturan Radio.
Tekan  untuk memilih.

Tombol Mikrofon Keypad









Anda dapat menggunakan keypad alfanumerik 3 x 4 pada Mikrofon Keypad Navigasi 4 Arah (Nomor komponen Motorola Solutions RMN5127_) untuk mengakses fitur radio. Untuk memperoleh karakter tertentu, Anda harus menekan tombol

- 4 Tekan  atau  ke Kenop Ganda. Tekan  untuk memilih.
Layar akan menampilkan Volume Saja dan Volume & Saluran.

- 5 Tekan  atau  ke pengaturan yang diinginkan. Tekan  untuk memilih.
Tanda ✓ muncul di sebelah pengaturan yang dipilih. Layar kembali ke menu sebelumnya.

beberapa kali. Tabel menunjukkan jumlah penekanan tombol yang diperlukan untuk memperoleh karakter yang diinginkan.

Kunci	Jumlah Penekanan Tombol												
	1	2	3	4	5	6	7	8	9	10	11	12	13
1 . , ? ! @ & ' % — : * #	1	.	,	?	!	@	&	'	%	—	:	*	#
2 ABC	A	B	C	2									
DEF 3	D	E	file	3									
4 GHI	G	H	I	4									
5 JKL	J	K	L	5									
MNO 6	M	N	O	6									

Kunci	Jumlah Penekanan Tombol												
	1	2	3	4	5	6	7	8	9	10	11	12	13
 7 PARS	P	Q	R	S	7								
 8 TUV	T	U	V	8									
 WXYZ9	W	X	Y	Z	9								
 0 CAPS	0		PEMBERITAHUAN: Tekan untuk memasukkan "0" dan tekan lama untuk mengaktifkan penggunaan huruf besar. Tekan lama sekali lagi untuk mematikan CAPS lock.										
 * del	*	atau del		PEMBERITAHUAN: Tekan saat mengetik teks untuk menghapus karakter. Tekan saat mengetik angka untuk memasukkan "*".									
 # spasi	#	atau spasi		PEMBERITAHUAN: Tekan saat mengetik teks untuk memasukkan spasi. Tekan saat mengetik angka untuk memasukkan "#".									

WAVE

Wide Area Voice Environment (WAVE™) memberikan metode baru dalam melakukan panggilan antara dua radio atau lebih.

WAVE memungkinkan Anda berkomunikasi di berbagai jaringan dan perangkat dengan Wi-Fi. Panggilan WAVE dibuat jika radio terhubung ke jaringan IP network melalui Wi-Fi.

Radio Anda mendukung konfigurasi sistem yang berbeda:

- WAVE OnCloud/OnPremise
- WAVE Tactical/5000

Metode untuk memulai Panggilan WAVE berbeda untuk setiap tipe sistem. Lihat bagian yang sesuai bergantung pada konfigurasi sistem radio Anda.

Tabel 1: Ikon Tampilan WAVE

Ikon berikut ini muncul sementara di tampilan jika WAVE diaktifkan.

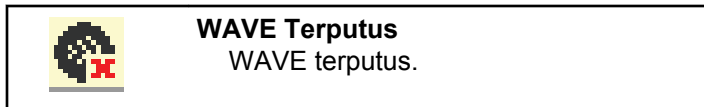
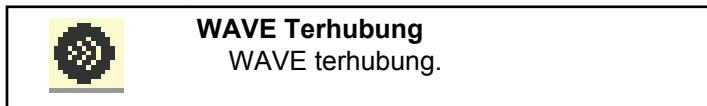

PEMBERITAHUAN:

Fitur ini hanya tersedia untuk model tertentu saja.

WAVE OnCloud/OnPremise

Beralih dari Mode Radio ke Mode WAVE

- 1 Lakukan salah satu langkah berikut:
 - Tekan tombol **WAVE** terprogram. Lompati langkah-langkah berikut ini.
 - Tekan  untuk mengakses menu.

- 2 Tekan  atau  ke WAVE. Tekan  untuk memilih.

LED kuning berkedip ganda.

Layar menampilkan pemberitahuan singkat Beralih ke WAVE, kemudian menampilkan Menyiapkan WAVE.



PEMBERITAHUAN:

Radio secara otomatis mengaktifkan Wi-Fi setelah Anda beralih ke mode WAVE.

Jika berhasil:

- Lampu LED berwarna kuning mati.
- Layar menampilkan ikon WAVE terhubung, <Alias Grup Bicara>, dan <Indeks Saluran>.

Jika tidak berhasil:

- Sebuah nada negatif akan berbunyi.
- LED merah berkedip.
- Layar menampilkan WAVE terputus dan Tidak Ada Koneksi atau Aktivasi: Gagal, bergantung pada jenis kesalahan.



PEMBERITAHUAN:

Sinkronisasi terjadi ketika pengaturan baru diperbarui ke radio. Saat Anda masuk ke mode WAVE, radio Anda menampilkan Menyinkronkan.... Setelah sinkronisasi selesai, radio Anda akan kembali ke layar utama.

Melakukan Panggilan Grup WAVE

- 1 Pilih grup bicara WAVE menggunakan kenop/tombol pemilih saluran.
-
- 2 Tekan tombol **PTT** untuk melakukan panggilan.

Jika berhasil, layar menampilkan ikon Panggilan Grup dan alias grup bicara WAVE.

Jika tidak berhasil:

- Nada indikator negatif akan berbunyi.
- Layar menampilkan pemberitahuan sementara Panggilan Gagal atau Tidak Ada Peserta.

Menerima dan Menjawab Panggilan Grup WAVE

Apabila Anda menerima panggilan grup WAVE:

- Nada akan berbunyi.
- Layar menampilkan ikon panggilan grup, alias grup bicara, dan alias pemanggil.

- Radio bersuara dan panggilan masuk berbunyi melalui speaker.

1 Tekan tombol **PTT** untuk menjawab panggilan.

2 Lepaskan tombol **PTT** untuk mendengarkan.

Menerima dan Menjawab Panggilan Pribadi WAVE

Apabila Anda menerima panggilan pribadi WAVE:

- Nada akan berbunyi.
- Layar menampilkan ikon panggilan pribadi dan alias pemanggil.
- Radio bersuara dan panggilan masuk berbunyi melalui speaker.

1 Tekan tombol **PTT** untuk menjawab panggilan.

2 Lepaskan tombol **PTT** untuk mendengarkan.

Beralih dari Mode WAVE ke Mode Radio

1 Lakukan salah satu langkah berikut:

- Tekan tombol **Mode Radio** yang terprogram. Lompati langkah-langkah berikut ini.
- Tekan  untuk mengakses menu.

2 Tekan  atau  ke Mode Radio. Tekan  untuk memilih.

LED kuning berkedip ganda.

Layar akan menampilkan pemberitahuan singkat Beralih ke Radio lalu menampilkan Menyiapkan Radio.

Jika berhasil:

- Lampu LED berwarna kuning mati.
- Ikon WAVE tersambung akan hilang pada bilah status. Layar menampilkan <Alias Grup Bicara> dan <Indeks Saluran>.

WAVE Tactical/5000



Mengatur Saluran WAVE Aktif









PEMBERITAHUAN:

Saluran WAVE dikonfigurasi melalui CPS. Radio secara otomatis mengaktifkan Wi-Fi dan masuk ke server WAVE setelah Anda masuk ke saluran WAVE.

- 1 Tekan  untuk mengakses menu.

- 2 Tekan  atau  ke Saluran WAVE. Tekan  untuk memilih.



- 3 Tekan  atau  ke saluran WAVE yang diinginkan. Tekan  untuk memilih.



- 4 Tekan  atau  ke Tetapkan sebagai Aktif. Tekan  untuk memilih.



Layar menampilkan  di sebelah saluran yang dipilih.

Menampilkan Informasi Saluran WAVE

- 1 Lakukan salah satu langkah berikut:
 - Tekan tombol **Daftar Saluran WAVE** yang diprogram. Lompati langkah-langkah berikut ini.
 - Tekan  untuk mengakses menu.

- 2 Tekan  atau  ke Saluran WAVE. Tekan  untuk memilih.



- 3 Tekan  atau  ke saluran WAVE yang diinginkan. Tekan  untuk memilih.



- 4 Tekan  atau  ke Lihat Detail. Tekan  untuk memilih.

Layar menampilkan detail saluran WAVE.

Menampilkan Informasi Endpoint WAVE

- 1 Lakukan salah satu langkah berikut:
 - Tekan tombol **Kontak** yang diprogram. Lewati ke [langkah 3](#).
 - Tekan  untuk mengakses menu.

- 2 Tekan  atau  ke Endpoint. Tekan  untuk memilih.

- 3 Tekan  atau  ke Endpoint WAVE yang diperlukan. Tekan  untuk memilih.



- 4 Tekan  untuk memilih Tampilkan Detail.



Layar menampilkan detail Endpoint WAVE.



Mengubah Konfigurasi WAVE



Ikuti prosedur untuk mengatur alamat IP server WAVE, ID pengguna, dan kata sandi.



- 1 Tekan  untuk mengakses menu.



- 2 Tekan  atau  ke Utilitas. Tekan  untuk memilih.



- 3 Tekan  atau  ke Pengaturan Radio. Tekan  untuk memilih.

- 4 Tekan  atau  ke WAVE. Tekan  untuk memilih.

- 5 Tekan  untuk memilih Alamat Server. Tekan  untuk mengubah alamat server. Tekan  untuk memilih.

- 6 Tekan  ke ID Pengguna. Tekan  untuk mengubah ID Pengguna. Tekan  untuk memilih.

7 Tekan  ke Kata Sandi. Tekan  untuk melihat atau mengubah kata sandi WAVE. Tekan  untuk memilih.

8 Tekan  ke Terapkan. Tekan  untuk menerapkan semua perubahan yang dilakukan.

Layar menampilkan pemberitahuan mini positif sebelum kembali ke layar Pengaturan Radio.

Melakukan Panggilan Grup WAVE

1 Pilih saluran WAVE dengan alias atau ID grup yang diperlukan.

2 Tekan tombol **PTT** untuk melakukan panggilan. LED hijau akan menyala. Baris teks pertama menampilkan ikon dan alias **Panggilan Grup**. Baris teks kedua menunjukkan alias grup WAVE.

3 Lakukan salah satu langkah berikut:

- Tunggu hingga Nada Izin Bicara selesai dan bicaralah dengan jelas ke mikrofon, jika diaktifkan.
 - Tunggu hingga Sidetone **PTT** selesai dan bicaralah dengan jelas ke mikrofon, jika diaktifkan
-

4 Lepaskan tombol **PTT** untuk mendengarkan.

LED hijau akan menyala jika radio target merespons. Layar menampilkan ikon dan alias atau ID **Panggilan Grup**, serta alias atau ID radio yang melakukan transmisi.

5 Jika fitur Indikasi Saluran Bebas diaktifkan, nada peringatan singkat akan berbunyi saat pengguna radio yang melakukan transmisi melepaskan tombol **PTT**, yang menunjukkan saluran bebas dapat Anda gunakan untuk merespons. Tekan tombol **PTT** untuk menjawab panggilan.

Panggilan berakhir jika tidak ada aktivitas suara selama waktu yang telah ditentukan. Radio kembali ke layar sebelum Anda melakukan panggilan.

Operasi Capacity Max

Capacity Max adalah saluran kontrol berdasarkan sistem radio trunk. Fitur yang tersedia untuk pengguna radio pada sistem ini tersedia dalam bab ini.

Tombol Tekan untuk Berbicara (PTT)

Tombol **PTT** memiliki dua fungsi dasar.

- Saat panggilan sedang berlangsung, tombol **PTT** memungkinkan radio untuk mengirim transmisi ke radio lain dalam panggilan. Mikrofon diaktifkan saat tombol **PTT** ditekan.
- Saat tidak sedang dalam panggilan, tombol **PTT** digunakan untuk melakukan panggilan baru.

Tekan dan tahan tombol **PTT** untuk berbicara. Lepaskan tombol **PTT** untuk mendengarkan.

Jika Nada Izin Bicara atau Sidetone **PTT** aktif, tunggu hingga nada peringatan singkat selesai diputar sebelum berbicara.

Jika fitur Indikasi Saluran Bebas di radio aktif (diprogram oleh penyalur), Anda akan mendengar nada peringatan

singkat diputar pada saat radio target (radio yang menerima panggilan) melepaskan tombol **PTT**, menunjukkan bahwa saluran bebas untuk menerima tanggapan Anda.

Anda akan terus mendengar Nada Larangan Bicara jika panggilan terganggu, misalnya saat radio menerima Panggilan darurat. Anda harus melepaskan tombol **PTT**.

Tombol yang Dapat Diprogram

Tergantung pada durasi penekanan tombol, dealer dapat memprogram tombol yang dapat diprogram sebagai pintasan fungsi radio.

Tekan sebentar

Menekan dan melepas dengan cepat.

Tekan lama

Menekan dan menahan selama durasi terprogram.



PEMBERITAHUAN:

Lihat [Pengoperasian Darurat di halaman 438](#) untuk informasi selengkapnya tentang durasi terprogram untuk tombol **Darurat**.

Fungsi Radio yang Dapat Ditetapkan

Fungsi radio berikut ini dapat dialokasikan ke tombol yang dapat diprogram oleh dealer atau administrator sistem.

Ambien Audio

Memungkinkan pengguna memilih lingkungan tempat pengoperasian radio.

Profil Audio

Memungkinkan pengguna memilih profil audio yang diinginkan.

Sakelar Audio Bluetooth®

Mengalihkan perutean audio antara speaker radio internal dan aksesori berkemampuan Bluetooth eksternal.

Hubungkan Bluetooth

Menginisiasi operasi pencarian dan sambungan Bluetooth.

Putus Sambungan Bluetooth

Menghentikan semua sambungan Bluetooth yang ada antara radio dan perangkat berkemampuan Bluetooth.

Bluetooth Dapat Ditemukan

Memungkinkan radio memasuki Mode Bluetooth Dapat Ditemukan.

Kontak

Memberikan akses langsung ke daftar Kontak.

Peringatan Panggilan

Menyediakan akses langsung ke daftar kontak untuk memilih kontak yang akan dikirim Peringatan Panggilan.

Log Panggilan

Memilih daftar log panggilan.

Darurat

Menginisiasi atau membatalkan status darurat, tergantung pemrogramannya.

Alamat Publik (Public Address/PA) Eksternal

Mengalihkan perutean audio antara amplifier penguat suara PA yang terhubung dan sistem PA internal radio.

Atur Ulang Saluran Home

Menyiapkan saluran home baru.

Senyapkan Pengingat Saluran Home

Mematikan suara Pengingat Saluran Home.

Lokasi Dalam Ruang

Mengaktifkan atau menonaktifkan Lokasi Dalam Ruang.

Audio Cerdas

Mengaktifkan atau menonaktifkan audio cerdas.

Panggilan Manual

Memulai Panggilan Pribadi dengan memasukkan ID subscriber apa pun.

Jelajah Site Manual

Memulai pencarian site secara manual.

AGC Mik

Mengaktifkan atau menonaktifkan automatic gain control (AGC) mikrofon internal.

Notifikasi

Memberikan akses langsung ke daftar Notifikasi.

Akses Satu Sentuhan

Langsung memulai Panggilan Siaran, Pribadi, Telepon atau Grup, Peringatan Panggilan, atau pesan Teks Cepat yang telah ditentukan.

Fitur Papan Opsi

Mengaktifkan atau menonaktifkan fitur papan opsi untuk saluran berkemampuan papan opsi.

Telepon

Memberikan akses langsung ke daftar Kontak Telepon.

Privasi

Mengaktifkan atau menonaktifkan privasi.

Alamat Publik (Public Address/PA)

Mengaktifkan atau menonaktifkan sistem PA internal radio.

Alias dan ID Radio

Memberikan alias dan ID radio.

Monitor Jarak Jauh

Mengaktifkan mikrofon radio target tanpa indikator apa pun.

Info Site

Menampilkan ID dan nama site Capacity Max saat ini.

Memutar pesan suara pengumuman site untuk site saat ini ketika Pengumuman Suara diaktifkan.

Kunci Site

Ketika diaktifkan, radio akan mencari site saat ini saja. Ketika dinonaktifkan, radio akan mencari site lain di samping site saat ini.

Kontrol Telemetry

Mengontrol Pin Output pada radio setempat atau yang berjarak jauh.

Pesan Teks

Memilih menu pesan teks.

Sakelar Level Prioritas Panggilan

Memungkinkan radio Anda masuk ke Level Prioritas Panggilan Tinggi/Normal.

Peningkatan Trill

Mengaktifkan atau menonaktifkan peningkatan trill.

Pengumuman Suara Aktif/Nonaktif

Mengaktifkan atau menonaktifkan pengumuman suara.

Pengumuman Suara untuk Saluran

Memutar pesan suara pengumuman zona dan saluran untuk saluran saat ini. Fungsi ini tidak tersedia jika Pengumuman Suara dinonaktifkan.

Wi-Fi

Mengaktifkan atau menonaktifkan Wi-Fi.

Pemilihan Zona

Memungkinkan pemilihan dari daftar zona.

Fungsi Utilitas atau Pengaturan yang Dapat Ditetapkan

Fungsi utilitas atau pengaturan radio berikut ini dapat ditetapkan ke tombol yang dapat diprogram.

Nada/Peringatan

Mengaktifkan atau menonaktifkan semua nada dan peringatan.

Lampu Latar

Menghidupkan atau mematikan lampu latar tampilan.

Saluran Naik/Turun

Tergantung pemrogramannya, mengubah saluran ke saluran sebelumnya atau berikutnya.

Mode Layar







Mengaktifkan atau menonaktifkan mode tampilan siang/malam hari.

Tingkat Daya

Mengganti antara tingkat kekuatan transmisi tinggi dan rendah.

Mengakses Fungsi Terprogram

Ikuti prosedur untuk mengakses fungsi-fungsi terprogram pada radio Anda.

- 1 Lakukan salah satu langkah berikut:
 - Tekan tombol yang diprogram. Lanjutkan ke [langkah 3](#).
 - Tekan  untuk mengakses menu.
- 2 Tekan  atau  ke fungsi menu, dan tekan  untuk memilih fungsi atau masuk sub-menu.
- 3 Lakukan salah satu langkah berikut:
 - Tekan  untuk kembali ke layar sebelumnya.
 - Tekan lama  untuk kembali ke layar Awal.

Radio keluar dari menu secara otomatis setelah tidak aktif selama waktu tertentu dan kembali ke layar Awal.

Tombol Navigasi Menu juga tersedia pada mikrofon keypad. Lihat [Tombol Mikrofon Keypad di halaman 39](#).

Indikator Status

Bab ini menjelaskan indikator status dan nada audio yang digunakan pada radio.

Ikon

Liquid Crystal Display (LCD) radio Anda menampilkan status radio, entri teks, dan entri menu.







Tabel 2: Ikon Layar



Ikon berikut ini muncul di bilah status pada bagian atas layar radio. Ikon disusun dari kiri berdasarkan kemunculan atau penggunaan, dan bersifat spesifik saluran.

	<p>BeiDou Only Tersedia¹ Fitur BeiDou Only diaktifkan. Ikon akan terus menyala bila posisi tetap telah tersedia.</p>
	<p>Bluetooth Tersambung Fitur Bluetooth diaktifkan. Ikon akan menyala bila perangkat Bluetooth jauh tersambung.</p>









	<p>Bluetooth Tidak Tersambung Fitur Bluetooth diaktifkan, tetapi tidak ada perangkat Bluetooth jauh yang tersambung.</p>
	<p>DGNA Radio berada dalam Grup Bicara DGNA.</p>
	<p>Darurat Radio dalam mode Darurat.</p>
	<p>GNSS Tersedia Fitur GNSS diaktifkan. Ikon akan terus menyala bila posisi tetap telah tersedia.</p>
	<p>GNSS Tidak Tersedia Fitur GNSS telah diaktifkan, tetapi tidak menerima data dari satelit.</p>
	<p>Data Volume Tinggi Radio menerima data volume tinggi dan saluran sedang sibuk.</p>

¹ Hanya berlaku untuk XiR M8660i/XiR M8668i/CM7668i.

	Lokasi Dalam Ruang Tersedia² Status lokasi dalam ruangan aktif dan tersedia.
	Lokasi Dalam Ruang Tidak Tersedia² Status lokasi dalam ruangan aktif tetapi tidak tersedia karena Bluetooth dinonaktifkan atau Beacons Scan dihentikan oleh Bluetooth.
	Mode Bisu Mode Bisu aktif dan speaker dibisukan.
	Notifikasi Daftar Notifikasi memiliki satu atau beberapa aktivitas yang terlewat.
	Papan Opsi Papan Opsi diaktifkan. (Hanya untuk model yang dilengkapi papan opsi)
	Papan Opsi Tidak Berfungsi Papan Opsi dinonaktifkan.

	Pencatat Waktu Penundaan Pemrograman Melalui Udara Menunjukkan waktu yang tersisa sebelum radio menyala ulang otomatis.
	Prioritas 1 Menunjukkan Grup Bicara Prioritas 1.
	Prioritas 2 Menunjukkan Grup Bicara Prioritas 2.
	Indikator Kekuatan Sinyal yang Diterima (Received Signal Strength Indicator/RSSI) Jumlah bar yang ditampilkan menunjukkan kekuatan sinyal radio. Empat bar menunjukkan sinyal terkuat. Ikon ini hanya ditampilkan saat menerima.
	Larangan Tanggapan Larangan Tanggapan aktif.

² Hanya berlaku untuk model dengan perangkat lunak dan perangkat keras terbaru.

	Hanya Dering Mode dering diaktifkan.
	Aman Fitur Privasi diaktifkan.
	Frekuensi Bersama Mengindikasikan radio mengunci untuk membagikan Saluran Kontrol.
	Dering Tanpa Bunyi Mode dering tanpa bunyi diaktifkan.
	Jelajah Site Fitur jelajah site diaktifkan.
	Status Menunjukkan pesan status baru.
	Nada Nonaktif Nada dinonaktifkan.
	Tidak Aman Fitur Privasi dinonaktifkan.



	Wi-Fi Sangat Baik³ Sinyal Wi-Fi sangat baik.
	Wi-Fi Baik³ Sinyal Wi-Fi baik.
	Wi-Fi Cukup³ Sinyal Wi-Fi cukup.
	Wi-Fi Jelek³ Sinyal Wi-Fi jelek.
	Wi-Fi Tidak Tersedia³ Sinyal Wi-Fi tidak tersedia.

Tabel 3: Ikon Menu Lanjutan

Ikon berikut ini muncul di samping item menu yang menawarkan pilihan di antara dua opsi atau sebagai indikasi bahwa ada sub-menu yang menawarkan dua opsi.



	Kotak Centang (Dicentang) Menunjukkan bahwa opsi dipilih.
---	---

³ Hanya berlaku untuk XiR M8668i/CM7668i.

	Kotak Centang (Kosong) Menunjukkan bahwa opsi tidak dipilih.
	Kotak Hitam Penuh Menunjukkan bahwa opsi dipilih untuk item menu dengan submenu.





Tabel 4: Ikon Perangkat Bluetooth

Ikon berikut juga ditampilkan di sebelah item dalam daftar perangkat berkemampuan Bluetooth yang tersedia untuk menunjukkan jenis perangkat.

	Perangkat Audio Bluetooth Perangkat audio berkemampuan Bluetooth, misalnya headset.
	Perangkat Data Bluetooth Perangkat data berkemampuan Bluetooth, misalnya scanner.
	Perangkat PTT Bluetooth Perangkat PTT berkemampuan Bluetooth, misalnya POD (PTT-Only Device).

Tabel 5: Ikon Panggilan

Ikon berikut ini muncul di layar selama panggilan. Ikon ini juga ditampilkan dalam daftar Kontak untuk menunjukkan jenis alias atau ID.

	Panggilan PC Bluetooth Menunjukkan Panggilan PC Bluetooth sedang berlangsung. Dalam daftar Kontak, ini ditunjukkan sebagai alias (nama) atau ID (nomor) Panggilan PC Bluetooth.
	Prioritas Panggilan Tinggi Mengindikasikan Level Prioritas Panggilan Tinggi telah diaktifkan.
	Panggilan DGNA Menunjukkan Panggilan DGNA sedang berlangsung.
	Panggilan Pengiriman Jenis kontak Panggilan Pengiriman digunakan untuk mengirim pesan teks ke PC pengirim melalui Server Pesan Teks pihak ketiga.



Panggilan Grup/Semua Panggilan

Menunjukkan Panggilan Grup atau Semua Panggilan sedang berlangsung.

Dalam daftar Kontak, ini ditunjukkan sebagai alias (nama) atau ID (nomor) grup.



Panggilan Pribadi

Menunjukkan Panggilan Pribadi sedang berlangsung.

Di Daftar Kontak, ini menunjukkan alias (nama) atau ID (nomor) subscriber.



Panggilan Telepon sebagai Panggilan Grup/Semua Panggilan

Menunjukkan Panggilan Telepon sebagai Panggilan Grup atau Semua Panggilan sedang berlangsung.

Dalam daftar Kontak, ini ditunjukkan sebagai alias (nama) atau ID (nomor) grup.



Panggilan Telepon sebagai Panggilan Pribadi

Menunjukkan Panggilan Telepon sebagai Panggilan Pribadi sedang berlangsung.

Dalam daftar Kontak, ini ditunjukkan sebagai alias (nama) atau ID (nomor) telepon.

Tabel 6: Ikon Tiket Tugas

Ikon berikut muncul sebentar pada layar dalam folder Tiket Tugas.



Semua Tugas

Menampilkan semua tugas tercantum.







Tugas Baru

Menampilkan tugas baru.



Sedang Berlangsung



Tugas dikirimkan. Hal ini dilihat sebelum indikasi untuk Mengirimkan Tiket Tugas Gagal atau Berhasil Terkirim.

	Gagal Terkirim Tugas tidak dapat dikirim.
	Berhasil Terkirim Tugas berhasil dikirim.
	Prioritas 1 Menunjukkan Tingkat Prioritas 1 untuk tugas.
	Prioritas 2 Menunjukkan Tingkat Prioritas 2 untuk tugas.
	Prioritas 3 Menunjukkan Tingkat Prioritas 3 untuk tugas.

Tabel 7: Ikon Pemberitahuan Mini



Ikon berikut ini ditampilkan sekilas di layar radio setelah tindakan untuk menjalankan sebuah tugas dilakukan.









	Transmisi Gagal (Negatif) Tindakan gagal dilakukan.
---	---

	Transmisi Berhasil (Positif) Tindakan berhasil dilakukan.
	Transmisi Sedang Berlangsung (Transisional) Mentransmisikan. Ikon terlihat sebelum indikasi Transmisi Berhasil atau Transmisi Gagal.

Tabel 8: Ikon Item Terkirim

Ikon berikut muncul di sudut kanan atas layar dalam folder Item Terkirim.

	Sedang Berlangsung Pesan teks ke alias atau ID subscriber sedang menunggu transmisi, diikuti dengan menunggu respons.
	Pesan teks ke alias atau ID grup sedang menunggu transmisi.

 atau 	<p>Pesan Terpisah atau Grup Telah Dibaca Pesan teks telah dibaca.</p>
 atau 	<p>Pesan Terpisah atau Grup Belum Dibaca Pesan teks belum dibaca.</p>
 atau 	<p>Gagal Terkirim Pesan teks tidak bisa terkirim.</p>
 atau 	<p>Berhasil Terkirim Pesan teks telah berhasil dikirim.</p>

Indikator LED

Indikator LED menunjukkan status operasional radio.

Merah Berkedip

Radio gagal melakukan uji mandiri saat dihidupkan.

Radio menerima transmisi darurat.

Radio melakukan transmisi dalam kondisi baterai lemah.

Radio keluar dari jangkauan jika Sistem Transponder Auto-Range dikonfigurasi.

Mode Bisu aktif.

Hijau Tak Berkedip

Radio dalam proses dihidupkan.

Radio melakukan transmisi.

Radio sedang mengirim Peringatan Panggilan atau transmisi darurat.

Hijau Berkedip

Radio menerima panggilan atau data.

Radio mengambil transmisi Pemrograman Melalui Udara melalui udara.

Radio mendeteksi aktivitas melalui udara.



PEMBERITAHUAN:

Aktivitas ini bisa memengaruhi saluran terprogram pada radio karena sifat dari protokol digital.

Hijau Berkedip Ganda

Radio menerima panggilan atau data dengan privasi diaktifkan.

Kuning Terus

Radio dalam Mode Bluetooth Dapat Ditemukan.

Kuning Berkedip

Radio belum merespons Peringatan Panggilan.

Kuning Berkedip Ganda

Jelajah Otomatis pada radio diaktifkan.

Radio secara aktif mencari site baru.

Radio belum merespons Peringatan Panggilan Grup.

Radio terkunci.

Nada

Berikut ini adalah nada yang keluar melalui speaker radio.



Nada Tinggi



Nada Rendah

Nada Audio

Nada audio memberi Anda indikasi status radio yang bisa didengar atau respons radio terhadap data yang diterima.



Nada Terus Menerus

Nada monoton. Berbunyi secara terus-menerus sampai dihentikan.



Nada Berkala

Berbunyi secara berkala bergantung pada durasi yang diatur oleh radio. Nada memulai, berhenti, dan mengulang sendiri.



Nada Berulang

Nada tunggal yang berulang dengan sendirinya sampai dihentikan oleh pengguna.



Nada Sesaat

Berbunyi sekali dalam durasi singkat yang diatur oleh radio.

Nada Indikator

Nada indikator memberi petunjuk suara tentang status setelah suatu tindakan untuk menjalankan tugas dilakukan.



Nada Indikator Positif



Nada Indikator Negatif

Registrasi

Ada sejumlah pesan terkait registrasi yang mungkin Anda terima.

Melakukan registrasi

Biasanya, registrasi dikirim ke sistem selama proses menyalakan, perubahan Grup Bicara, atau selama jelajah site. Jika gagal melakukan registrasi di sebuah site, radio akan mencoba menjelajah ke site lain secara otomatis. Radio akan menghapus sementara site tempat registrasi dicoba dari daftar jelajah.

Indikasi menunjukkan bahwa radio sedang sibuk mencari site untuk dijelajahi, atau bahwa radio telah berhasil

menemukan site, tetapi menunggu jawaban atas pesan registrasi dari radio.

Saat Melakukan registrasi ditampilkan di radio, nada akan berbunyi dan LED kuning berkedip ganda untuk menandakan pencarian site.

Jika indikasi terus ada, pengguna harus mengubah lokasi atau jika diizinkan, menjelajah ke site lain secara manual.

Di Luar Jangkauan

Radio dianggap berada di luar jangkauan jika tidak dapat mendeteksi sinyal dari sistem atau dari site saat ini. Biasanya, indikasi ini menunjukkan bahwa radio berada di luar jangkauan frekuensi radio (RF) keluar geografis.

Bila Di Luar Jangkauan ditampilkan di radio, nada berulang akan berbunyi dan LED merah berkedip.

Hubungi dealer atau administrator sistem jika radio masih menerima indikasi di luar jangkauan saat berada di area dengan jangkauan RF yang kuat.

Afiliasi Grup Bicara Gagal

Radio mencoba mengafiliasi ke Grup Bicara yang ditentukan di saluran atau Posisi Kenop Terpadu (UKP) selama registrasi.

Radio dengan status afiliasi gagal tidak dapat melakukan atau menerima panggilan dari Grup Bicara yang dicoba untuk diafiliasi oleh radio tersebut.

Saat radio gagal mengafiliasi dengan suatu Grup Bicara, Alias UKP ditampilkan di layar awal dengan latar belakang disorot.

Hubungi dealer atau administrator sistem jika radio menerima indikasi kegagalan afiliasi.

Register Ditolak

Radio menerima indikator registrasi ditolak bila proses registrasi dengan sistem tidak diterima.

Radio tidak menunjukkan alasan spesifik penolakan registrasi kepada pengguna radio. Umumnya, suatu registrasi ditolak jika operator sistem menonaktifkan akses radio tersebut ke sistem.

Bila registrasi radio ditolak, Register Ditolak akan ditampilkan di radio dan LED kuning berkedip ganda untuk menandakan pencarian site.

Pemilihan Zona dan Saluran

Bab ini menjelaskan pengoperasian untuk memilih zona atau saluran di radio Anda.

Radio dapat diprogram dengan maksimum 250 Zona Capacity Max dengan maksimum 160 Saluran per zona. Setiap zona Capacity Max berisi maksimum 16 posisi yang dapat dialokasikan. Setiap zona Capacity Max berisi maksimum 16 posisi yang dapat dialokasikan.

Memilih Zona



Ikuti prosedur untuk memilih zona yang diperlukan di radio Anda.

1 Lakukan salah satu langkah berikut:

- Tekan tombol **Pemilihan Zona** terprogram. Lanjutkan ke [langkah 3](#).
- Tekan  untuk mengakses menu.





2 Tekan  atau  ke Zona. Tekan  untuk memilih.

Layar menampilkan  dan zona saat ini.

- 3 Tekan  atau  ke zona yang diinginkan.
- Tekan  untuk memilih.
- Layar sesaat menampilkan pesan <Zona>
Terpilih dan kembali ke layar zona yang dipilih.
-

Memilih Zona Menggunakan Pencarian Alias

Ikuti prosedur untuk memilih zona yang diperlukan di radio Anda menggunakan pencarian alias.

- 1 Tekan  untuk mengakses menu.
-
- 2 Tekan  atau  ke Zona. Tekan  untuk memilih.
- Layar menampilkan  dan zona saat ini.
-
- 3 Masukkan karakter pertama dari alias yang diinginkan.
- Layar menampilkan kursor berkedip.
-

- 4 Masukkan sisa karakter dari alias yang diperlukan.
- Pencarian alias peka terhadap huruf besar-kecil. Jika terdapat dua entri atau lebih dengan nama yang sama, layar akan menampilkan entri pertama yang tercantum dalam daftar.
- Baris teks pertama menampilkan karakter yang Anda masukkan. Baris teks berikut ini menampilkan hasil pencarian daftar pendek.
-

- 5 Tekan  untuk memilih.
- Layar sesaat menampilkan pesan <Zona>
Terpilih dan kembali ke layar zona yang dipilih.
-

Memilih Jenis Panggilan

Gunakan Kenop Pemilih Saluran untuk memilih jenis panggilan. Ini bisa jadi Panggilan Grup, Panggilan Siaran, Semua Panggilan, atau Panggilan Pribadi, bergantung pada bagaimana radio Anda diprogram. Jika Anda ubah Kenop Pemilih Saluran ke posisi berbeda (yang memiliki jenis panggilan yang telah ditetapkan), ini menyebabkan radio mendaftarkan ulang ke Sistem Capacity Max. Radio akan

mendaftar dengan ID Talkgrup yang telah diprogram untuk posisi Kenop Pemilih Saluran jenis panggilan baru.

Radio Anda tidak beroperasi ketika dipilih ke saluran yang tidak diprogram, gunakan Kenop Pemilih Saluran untuk memilih saluran yang telah diprogram.

Setelah zona yang diinginkan ditampilkan (jika Anda memiliki beberapa zona di radio), putar Kenop Pemilih Saluran terprogram untuk memilih jenis panggilan.

Memilih Site

Site menyediakan jangkauan untuk area spesifik. Dalam jaringan multisite, radio Capacity Max akan otomatis mencari site baru ketika tingkat sinyal dari site saat ini turun ke tingkat yang tak bisa diterima.

Sistem Capacity Max dapat mendukung hingga 250 site.

Permintaan Jelajah

Permintaan Jelajah memberi tahu radio untuk mencari site yang berbeda, meski sinyal dari site saat ini dapat diterima.

Jika tidak ada site yang tersedia:

- Layar radio menampilkan Mencari dan melanjutkan pencarian ke seluruh daftar site.
- Radio akan kembali ke site sebelumnya, jika site sebelumnya masih tersedia.



PEMBERITAHUAN:

Hal ini diprogram oleh dealer Anda.

Tekan tombol **Jelajah Site Manual** terprogram.

Anda mendengar nada, yang menunjukkan radio telah beralih ke site baru. Layar menampilkan ID Site <Nomor Site>.

Kunci Site Aktif/Nonaktif

Ketika diaktifkan, radio akan mencari site saat ini saja. Ketika dinonaktifkan, radio akan mencari site lain di samping site saat ini.

Tekan tombol **Kunci Site**.

Jika fungsi **Kunci Site** diaktifkan:

- Anda mendengar nada indikator positif, yang menunjukkan radio telah dikunci ke site saat ini.
- Layar akan menampilkan Site Terkunci.

Jika fungsi **Kunci Site** dinonaktifkan:

- Anda mendengar nada indikator negatif, menandakan bahwa radio tidak terkunci.
- Layar akan menampilkan **Site Tidak Terkunci**.

Batasan Site

Pada sistem Capacity Max, administrator radio Anda memiliki kemampuan untuk menentukan site jaringan mana yang boleh dan tidak boleh digunakan radio Anda.

Radio tidak perlu diprogram ulang untuk mengubah daftar site yang diperbolehkan dan tidak diperbolehkan. Jika radio Anda berupaya mendaftar ke site yang tidak diperbolehkan, radio akan menerima indikasi bahwa site ditolak. Radio kemudian mencari site jaringan yang berbeda.

Bila mengalami pembatasan site, radio Anda menampilkan **Register Ditolak** dan LED kuning berkedip ganda untuk menandakan pencarian site.

Trunking Site

Site harus dapat berkomunikasi dengan Pengontrol Trunk agar dianggap sebagai Trunking Sistem.

Jika site tidak dapat berkomunikasi dengan Pengontrol Trunk di sistem, radio akan masuk ke mode Trunking Site. Selama dalam mode Trunking Site, radio memberikan indikasi suara dan visual secara berkala untuk menginformasikan keterbatasan fungsionalitasnya kepada pengguna.

Saat dalam mode Trunking Site, radio menampilkan **Trunking Site** dan membunyikan nada berulang.

Radio yang berada dalam mode Trunking Site masih dapat melakukan panggilan suara grup dan individu serta mengirim pesan teks ke radio lain di dalam site yang sama. Konsol suara, perekam log, gateway telepon, dan aplikasi data tidak dapat berkomunikasi dengan radio pada site tersebut.

Setelah dalam Trunking Site, radio yang terlibat dalam panggilan di sejumlah site hanya akan dapat berkomunikasi dengan radio lain di site yang sama. Komunikasi ke dan dari site lain akan terputus.



PEMBERITAHUAN:

Jika ada beberapa site yang mencakup lokasi radio saat ini dan salah satu site tersebut masuk ke Trunking Site, radio akan menjelajah ke site lain jika ada dalam jangkauan.

Panggilan

Bab ini menjelaskan pengoperasian untuk menerima, merespons, melakukan, dan menghentikan panggilan.

Anda dapat memilih alias atau ID subscriber, atau alias atau ID grup setelah memilih saluran menggunakan satu dari fitur-fitur berikut ini:

Pencarian Alias

Metode ini digunakan untuk Panggilan Grup, Pribadi, dan Semua Panggilan saja dengan mikrofon keypad.

Daftar Kontak

Metode ini memberikan akses langsung ke daftar Kontak.

Panggilan Manual (menggunakan Kontak)

Metode ini digunakan untuk Panggilan Pribadi dan Telepon saja dengan mikrofon keypad.

Tombol Angka Terprogram

Metode ini digunakan untuk Panggilan Grup, Pribadi, dan Semua Panggilan saja dengan mikrofon keypad.



PEMBERITAHUAN:

Anda hanya dapat mempunyai satu alias atau ID yang dialokasikan ke satu tombol angka, tetapi beberapa tombol angka dapat dialokasikan ke satu alias atau ID. Semua tombol angka pada mikrofon keypad dapat dialokasikan. Lihat [Mengalokasikan Entri ke Tombol Angka yang Dapat Diprogram di halaman 423](#) untuk informasi selengkapnya.

Tekan Tombol Akses Satu Sentuhan

Metode ini hanya digunakan untuk Panggilan Grup, Pribadi, dan Telepon.

Hanya satu ID yang dapat dialokasikan ke tombol **Akses Satu Sentuhan** dengan menekan tombol yang dapat diprogram lama atau sebentar. Radio Anda bisa mempunyai beberapa tombol **Akses Satu Sentuhan** terprogram.

Tombol yang Dapat Diprogram

Metode ini digunakan untuk Panggilan Telepon saja.

Kenop Pemilih Saluran/Volume

Metode ini memilih alias atau ID subscriber, atau alias atau grup secara manual.

Lampu LED menyala hijau terus ketika radio sedang mengirimkan transmisi dan berkedip ketika radio sedang menerima.



PEMBERITAHUAN:

Lampu LED menyala hijau terus ketika radio sedang mentransmisikan dan berkedip hijau dua kali ketika radio menerima panggilan dengan privasi diaktifkan.

Untuk menguraikan panggilan dengan privasi aktif, radio harus memiliki Kunci Privasi, atau Nilai Kunci dan ID Kunci yang sama (diprogram oleh dealer) seperti radio yang melakukan transmisi (radio yang mengirimkan panggilan kepada Anda).

Lihat [Privasi di halaman 475](#) untuk informasi selengkapnya.

Panggilan Grup

Radio harus dikonfigurasi sebagai bagian dari grup untuk menerima panggilan dari atau melakukan panggilan ke sekelompok pengguna.

Melakukan Panggilan Grup

Untuk melakukan panggilan ke sebuah grup pengguna, radio Anda harus dikonfigurasi sebagai bagian dari grup

itu. Ikuti prosedur untuk melakukan Panggilan Grup di radio Anda.

- 1 Lakukan salah satu langkah berikut:
 - Pilih saluran dengan ID atau alias grup yang aktif. Lihat [Memilih Jenis Panggilan di halaman 63](#).
 - Tekan tombol **Akses Satu Sentuhan** terprogram.

- 2 Tekan tombol **PTT** untuk melakukan panggilan. LED hijau akan menyala. Baris teks pertama menampilkan ikon dan alias **Panggilan Grup**.

- 3 Lakukan salah satu langkah berikut:
 - Tunggu hingga Nada Izin Bicara selesai dan bicaralah dengan jelas ke mikrofon, jika diaktifkan.
 - Tunggu hingga Sidetone **PTT** selesai dan bicaralah dengan jelas ke mikrofon, jika diaktifkan.

- 4 Lepaskan tombol **PTT** untuk mendengarkan. LED hijau akan menyala jika radio target merespons. Layar menampilkan ikon dan alias atau ID

Panggilan Grup, serta alias atau ID radio yang melakukan transmisi.

- 5 Jika fitur Indikasi Saluran Bebas diaktifkan, nada peringatan singkat akan berbunyi saat pengguna radio yang melakukan transmisi melepaskan tombol **PTT**, yang menunjukkan saluran bebas dapat Anda gunakan untuk merespons. Tekan tombol **PTT** untuk menjawab panggilan.

Panggilan berakhir jika tidak ada aktivitas suara selama waktu yang telah ditentukan.

Inisiator panggilan dapat menekan  untuk mengakhiri Panggilan Grup.

Melakukan Panggilan Grup Menggunakan Daftar Kontak

Ikuti prosedur untuk melakukan Panggilan Grup di radio Anda menggunakan daftar Kontak.

- 1 Tekan  untuk mengakses menu.
-

- 2 Tekan  atau  ke Kontak. Tekan  untuk memilih.
-

- 3 Tekan  atau  ke alias atau ID yang diinginkan. Tekan  untuk memilih.
-

- 4 Tekan tombol **PTT** untuk melakukan panggilan. LED hijau akan menyala. Baris pertama akan menampilkan nama atau ID subscriber. Baris kedua menampilkan Panggilan Grup dan ikon **Panggilan Grup**.
-

- 5 Lakukan salah satu langkah berikut:
- Tunggu hingga Nada Izin Bicara selesai dan bicaralah dengan jelas ke mikrofon, jika diaktifkan.
 - Tunggu hingga Sidetone **PTT** selesai dan bicaralah dengan jelas ke mikrofon, jika diaktifkan.
-

- 6 Lepaskan tombol **PTT** untuk mendengarkan.

LED hijau berkedip ketika ada pengguna dalam grup yang merespons. Layar menampilkan ikon dan alias atau ID **Panggilan Grup**, serta alias atau ID radio yang melakukan transmisi.

- 7 Jika fitur Indikasi Saluran Bebas diaktifkan, nada peringatan singkat akan berbunyi saat pengguna radio yang melakukan transmisi melepaskan tombol **PTT**, yang menunjukkan saluran bebas dapat Anda gunakan untuk merespons. Tekan tombol **PTT** untuk menjawab panggilan.

Panggilan berakhir jika tidak ada aktivitas suara selama waktu yang telah ditentukan.

Inisiator panggilan dapat menekan  untuk mengakhiri Panggilan Grup.

Anda akan mendengar nada pendek. Layar menampilkan pesan Panggilan Diakhiri.

Melakukan Panggilan Grup Menggunakan Tombol Angka yang Dapat Diprogram

Ikuti prosedur untuk melakukan Panggilan Grup di radio Anda menggunakan tombol angka yang dapat diprogram.

- 1 Tekan lama tombol angka terprogram ke alias atau ID yang telah ditentukan ketika Anda berada di layar Awal.

Jika sebuah tombol angka dialokasikan untuk sebuah entri dalam mode tertentu, fitur ini tidak didukung apabila Anda menekan lama tombol angka dalam mode yang lain.

Nada indikator negatif akan terdengar jika tombol angka tidak berhubungan dengan sebuah entri.

- 2 Tekan tombol **PTT** untuk melakukan panggilan. LED hijau akan menyala.
-

- 3 Lepaskan tombol **PTT** untuk mendengarkan. LED hijau berkedip ketika ada pengguna dalam grup yang merespons.
-

- 4 Jika fitur Indikasi Saluran Bebas diaktifkan, nada peringatan singkat akan berbunyi saat pengguna radio yang melakukan transmisi melepaskan tombol **PTT**, yang menunjukkan saluran bebas dapat Anda gunakan untuk merespons. Tekan tombol **PTT** untuk menjawab panggilan.

Panggilan berakhir jika tidak ada aktivitas suara selama waktu yang telah ditentukan. Radio kembali ke layar sebelum Anda melakukan panggilan.

Inisiator panggilan dapat menekan  untuk mengakhiri Panggilan Grup.

Lihat [Mengalokasikan Entri ke Tombol Angka yang Dapat Diprogram di halaman 423](#) untuk informasi selengkapnya.



Melakukan Panggilan Grup Menggunakan Pencarian Alias

Anda juga dapat menggunakan pencarian alias atau alfanumerik untuk memperoleh alias subscriber yang diperlukan. Fitur ini hanya tersedia saat dalam Kontak. Ikuti prosedur untuk melakukan panggilan apa pun menggunakan pencarian alias.



- 1 Tekan  untuk mengakses menu.

- 2 Tekan  atau  ke Kontak. Tekan  untuk memilih.

Layar menampilkan entri sesuai urutan abjad.

- 3 Tekan  atau  ke alias atau ID subscriber yang diinginkan. Baris pertama layar menampilkan Nomor Telepon:. Baris kedua layar menampilkan kursor yang berkedip. Gunakan keypad untuk memasukkan nomor telepon.

- 4 Tekan  untuk memilih. Jika entri yang dipilih kosong, nada indikator negatif akan berbunyi dan layar menampilkan Panggilan Telepon Tidak Valid #.

- 5 Tekan  atau  ke Panggil Telepon dan Tekan  untuk memilih. Jika kode akses tidak dikonfigurasi sebelumnya dalam daftar Kontak, baris pertama pada layar menampilkan Kode Akses:. Baris kedua layar menampilkan kursor yang



berkedip. Masukkan kode akses dan tekan tombol

 untuk melanjutkan. Jika berhasil, nada DTMF terdengar. Nada panggilan dari pengguna telepon akan terdengar. Baris pertama layar menampilkan alias atau ID subscriber, dan ikon RSSI. Baris kedua layar menampilkan Panggil Telepon dan ikon Panggilan Telepon. Jika tidak berhasil, nada terdengar dan layar menampilkan Panggilan Telepon Gagal. Radio Anda kembali ke layar input Kode Akses. Jika kode akses telah dikonfigurasi sebelumnya di daftar Kontak, radio akan kembali ke layar tempat Anda berada sebelum memulai panggilan.

-
- 6 Tekan tombol **PTT** untuk berbicara dan lepaskan untuk mendengarkan. Ikon **RSSI** tidak ditampilkan selama transmisi.
-
- 7 Untuk memasukkan digit ekstra, jika diminta oleh Panggilan Telepon, lakukan salah satu hal berikut.
- Tekan sembarang tombol keypad untuk mulai memasukkan digit ekstra. Baris pertama layar menampilkan Digit Ekstra:. Baris kedua layar menampilkan kursor yang berkedip. Masukkan digit ekstra dan tekan tombol  untuk

melanjutkan. Nada DTMF terdengar dan radio kembali ke layar sebelumnya.

- Tekan tombol **Akses Satu Sentuhan**. Nada DTMF akan berbunyi. Jika entri untuk tombol **Akses Satu Sentuhan** kosong, nada indikator negatif akan berbunyi.

-
- 8 Tekan  untuk mengakhiri panggilan. Jika kode de-akses tidak dikonfigurasi sebelumnya dalam daftar Kontak, baris pertama layar akan menampilkan De-Access Code: (Kode De-Akses:). Baris kedua layar menampilkan kursor yang berkedip. Masukkan kode de-akses dan tekan  untuk melanjutkan. Radio kembali ke layar sebelumnya. Nada DTMF berbunyi dan layar menampilkan Ending Phone Call (Mengakhiri Panggilan Telepon). Jika berhasil, nada terdengar dan layar menampilkan Panggilan Telepon Diakhiri. Radio Anda kembali ke layar Panggilan Telepon. Jika tidak berhasil, radio Anda kembali ke layar Panggilan Telepon. Jika Anda menekan tombol **PTT** saat berada di layar Kontak Telepon, nada akan berbunyi dan layar menampilkan Tekan OK untuk Melakukan Panggilan. Jika pengguna telepon mengakhiri panggilan, nada berbunyi dan layar

menampilkan dan layar menampilkan Phone Call Ended (Panggilan Telepon Diakhiri). Jika panggilan berakhir saat Anda memasukkan digit ekstra yang diminta oleh Panggilan Telepon, radio kembali ke layar yang dibuka sebelum Anda memulai panggilan.

- 9 Jika fitur Indikasi Saluran Bebas diaktifkan, nada peringatan singkat akan berbunyi saat pengguna radio yang melakukan transmisi melepaskan tombol **PTT**, yang menunjukkan saluran bebas dapat Anda gunakan untuk merespons. Tekan tombol **PTT** untuk menjawab panggilan.



Panggilan berakhir jika tidak ada aktivitas suara selama waktu yang telah ditentukan. Nada akan berbunyi. Layar menampilkan pesan Panggilan Diakhiri.

Inisiator panggilan dapat menekan  untuk mengakhiri Panggilan Grup.



PEMBERITAHUAN:

Selama akses saluran, tekan  untuk menghentikan percobaan panggilan dan nada akan berbunyi atau untuk keluar dari pencarian alias.

Tekan tombol  atau  untuk keluar dari pencarian alias. Selama panggilan, saat Anda menekan tombol **Akses Satu Sentuhan** dengan kode de-akses yang dikonfigurasi sebelumnya atau memasukkan kode de-akses sebagai input untuk digit ekstra, radio akan mencoba mengakhiri panggilan. Saat mengakses saluran dan melakukan transmisi kode akses/de-akses atau digit ekstra, radio hanya merespons tombol On/Off, Kenop Volume, dan Pemilih Saluran. Nada akan berbunyi untuk tiap input yang tidak valid.

Merespons Panggilan Grup

Ikuti prosedur untuk merespons Panggilan Grup di radio Anda.

Bila menerima Panggilan Grup:

- LED akan berkedip hijau.
- Layar menampilkan ikon **Panggilan Grup** di sudut kanan atas.

- Baris teks pertama menampilkan alias pemanggil.
- Baris teks kedua menunjukkan alias panggilan grup.
- Radio bersuara dan panggilan masuk berbunyi melalui speaker.

1 Lakukan salah satu langkah berikut:

- Jika fitur Indikasi Saluran Bebas diaktifkan, nada peringatan singkat akan berbunyi saat pengguna radio yang melakukan transmisi melepaskan tombol **PTT**, yang menunjukkan saluran bebas dapat Anda gunakan untuk merespons. Tekan tombol **PTT** untuk menjawab panggilan.
- Jika Interupsi Suara diaktifkan, tekan tombol **PTT** untuk menginterupsi audio dari radio yang melakukan transmisi dan membebaskan saluran sehingga Anda dapat merespons.

LED hijau akan menyala.

2 Lakukan salah satu langkah berikut:

- Tunggu hingga Nada Izin Bicara selesai dan bicaralah dengan jelas ke mikrofon, jika diaktifkan.

- Tunggu hingga Sidetone **PTT** selesai dan bicaralah dengan jelas ke mikrofon, jika diaktifkan.

3 Lepaskan tombol **PTT** untuk mendengarkan.

Panggilan berakhir jika tidak ada aktivitas suara selama waktu yang telah ditentukan.

Panggilan Siaran

Panggilan Siaran adalah panggilan suara satu arah dari pengguna ke seluruh grup bicara.

Fitur Panggilan Siaran memungkinkan hanya pengguna yang memulai panggilan yang melakukan transmisi ke grup bicara, sedangkan penerima panggilan tidak dapat merespons.

Pengguna yang memulai siaran juga dapat mengakhiri panggilan siaran. Untuk menerima panggilan dari sekelompok pengguna, atau untuk memanggil sekelompok pengguna, radio harus dikonfigurasi sebagai bagian dari grup.

Melakukan Panggilan Siaran

Ikuti prosedur untuk melakukan Panggilan Siaran di radio Anda.

- 1 Lakukan salah satu langkah berikut:
 - Pilih saluran dengan ID atau alias grup yang aktif. Lihat [Memilih Jenis Panggilan di halaman 63](#).
 - Tekan tombol **Akses Satu Sentuhan** terprogram.





-
- 2 Tekan tombol **PTT** untuk melakukan panggilan. LED hijau akan menyala. Layar menampilkan ikon dan alias **Panggilan Grup**.

-
- 3 Lakukan salah satu langkah berikut:
 - Tunggu hingga Nada Izin Bicara selesai dan bicaralah dengan jelas ke mikrofon, jika diaktifkan.
 - Tunggu hingga Sidetone **PTT** selesai dan bicaralah dengan jelas ke mikrofon, jika diaktifkan.

Inisiator panggilan dapat menekan  untuk mengakhiri Panggilan Siaran.

Melakukan Panggilan Siaran Menggunakan Daftar Kontak

Ikuti prosedur untuk melakukan Panggilan Siaran di radio Anda menggunakan daftar Kontak.

- 1 Tekan  untuk mengakses menu.
-
- 2 Tekan  atau  ke Kontak. Tekan  untuk memilih.

-
- 3 Tekan  atau  ke alias atau ID yang diinginkan. Tekan  untuk memilih.

-
- 4 Tekan tombol **PTT** untuk melakukan panggilan. LED akan berkedip hijau. Baris pertama akan menampilkan nama atau ID subscriber. Baris kedua menampilkan Panggilan Grup dan ikon **Panggilan Grup**.

-
- 5 Lakukan salah satu langkah berikut:

- Tunggu hingga Nada Izin Bicara selesai dan bicaralah dengan jelas ke mikrofon, jika diaktifkan.
- Tunggu hingga Sidetone **PTT** selesai dan bicaralah dengan jelas ke mikrofon, jika diaktifkan.

Inisiator panggilan dapat menekan  untuk mengakhiri Panggilan Siaran.

Melakukan Panggilan Siaran Menggunakan Tombol Angka yang Dapat Diprogram

Ikuti prosedur untuk melakukan Panggilan Siaran di radio Anda menggunakan tombol angka yang dapat diprogram.

- 1 Tekan lama tombol angka terprogram ke alias atau ID yang telah ditentukan ketika Anda berada di layar Awal.

Jika sebuah tombol angka dialokasikan untuk sebuah entri dalam mode tertentu, fitur ini tidak didukung apabila Anda menekan lama tombol angka dalam mode yang lain.

Nada indikator negatif akan terdengar jika tombol angka tidak berhubungan dengan sebuah entri.

- 2 Tekan tombol **PTT** untuk melakukan panggilan. LED hijau akan menyala. Layar menampilkan ikon **Panggilan Grup** di sudut kanan atas. Baris teks pertama menampilkan alias pemanggil.

- 3 Lakukan salah satu langkah berikut:

- Tunggu hingga Nada Izin Bicara selesai dan bicaralah dengan jelas ke mikrofon, jika diaktifkan.
- Tunggu hingga Sidetone **PTT** selesai dan bicaralah dengan jelas ke mikrofon, jika diaktifkan.

Inisiator panggilan dapat menekan  untuk mengakhiri Panggilan Siaran.

Menerima Panggilan Siaran

Ikuti prosedur untuk menerima Panggilan Siaran di radio Anda.

Apabila Anda menerima Panggilan Siaran:

- LED akan berkedip hijau.
- Layar menampilkan ikon **Panggilan Grup** di sudut kanan atas.
- Baris teks pertama menampilkan alias pemanggil.
- Baris teks kedua menunjukkan alias panggilan grup.
- Radio bersuara dan panggilan masuk berbunyi melalui speaker.



PEMBERITAHUAN:

Pengguna penerima tidak diizinkan melakukan Talkback selama Panggilan Siaran. Layar menampilkan **Talkback Dilarang**. Nada Talkback Dilarang akan berbunyi sesaat jika tombol **PTT** ditekan selama Panggilan Siaran.

Panggilan Pribadi

Panggilan Pribadi adalah sebuah panggilan dari radio perorangan ke radio perorangan lainnya.

Ada dua cara untuk menyiapkan Panggilan Pribadi.

- Jenis yang pertama disebut Penyiapan Panggilan Off Air (OACSU). OACSU menyiapkan panggilan setelah melakukan pemeriksaan kehadiran radio dan melakukan panggilan secara otomatis.

- Jenis yang kedua disebut Penyiapan Panggilan Off Air Penuh (FOACSU). FOACSU juga menyiapkan panggilan setelah melakukan pemeriksaan kehadiran radio. Namun demikian, panggilan FOACSU memerlukan respons pengguna untuk melakukan panggilan dan mengizinkan pengguna Menerima atau Menolak panggilan.

Jenis panggilan dikonfigurasi oleh administrator sistem.



PEMBERITAHUAN:

Pemanggil dan penerima panggilan dapat memutus Panggilan Pribadi yang sedang berlangsung

dengan menekan .

Melakukan Panggilan Pribadi

Radio Anda harus diprogram sebelum Anda memulai Panggilan Pribadi. Jika fitur tidak diaktifkan, nada indikator negatif berbunyi ketika Anda memulai panggilan. Ikuti prosedur untuk melakukan Panggilan Pribadi di radio Anda. Jika radio target tidak tersedia, nada pendek akan berbunyi dan layar menampilkan **Pihak Tidak Tersedia**.

- 1 Lakukan salah satu langkah berikut:

- Pilih saluran dengan ID atau alias subscriber yang aktif. Lihat [Memilih Jenis Panggilan di halaman 63](#).
- Tekan tombol **Akses Satu Sentuhan** terprogram.

2 Tekan tombol **PTT** untuk melakukan panggilan. LED hijau akan menyala. Layar menampilkan ikon **Panggilan Pribadi**, alias subscriber, dan status panggilan.

3 Tunggu hingga Nada Izin Bicara selesai dan bicaralah dengan jelas ke mikrofon, jika diaktifkan.

4 Lepaskan tombol **PTT** untuk mendengarkan. LED hijau akan menyala jika radio target merespons.

5 Panggilan berakhir jika tidak ada aktivitas suara selama waktu yang telah ditentukan. Anda akan mendengar nada pendek. Layar menampilkan **Panggilan Diakhiri**.
Pemanggil dan penerima panggilan dapat memutus Panggilan Pribadi yang sedang berlangsung dengan menekan .

Melakukan Panggilan Pribadi Menggunakan Tombol Angka yang Dapat Diprogram

Ikuti prosedur untuk melakukan Panggilan Pribadi di radio Anda menggunakan tombol angka yang dapat diprogram.

- 1** Tekan lama tombol angka terprogram ke alias atau ID yang telah ditentukan ketika Anda berada di layar Awal.

Jika sebuah tombol angka dialokasikan untuk sebuah entri dalam mode tertentu, fitur ini tidak didukung apabila Anda menekan lama tombol angka dalam mode yang lain.

Nada indikator negatif akan terdengar jika tombol angka tidak berhubungan dengan sebuah entri.

- 2** Tekan tombol **PTT** untuk melakukan panggilan. LED hijau akan menyala. Layar menampilkan ikon **Panggilan Pribadi** di sudut kanan atas. Baris teks pertama menampilkan alias pemanggil. Baris teks kedua menunjukkan status panggilan.
-



- 3 Lepaskan tombol **PTT** untuk mendengarkan.
LED hijau akan berkedip jika radio target merespons. Layar menampilkan alias tujuan.
-



- 4 Panggilan berakhir jika tidak ada aktivitas suara selama waktu yang telah ditentukan. Anda akan mendengar nada pendek. Layar menampilkan pesan Panggilan Diakhiri.
Pemanggil dan penerima panggilan dapat memutus Panggilan Pribadi yang sedang berlangsung dengan menekan .
-

Lihat [Mengalokasikan Entri ke Tombol Angka yang Dapat Diprogram di halaman 423](#) untuk informasi selengkapnya.





Melakukan Panggilan Pribadi Menggunakan Pencarian Alias

- 1 Tekan  untuk mengakses menu.
-

- 2 Tekan  atau  ke Kontak. Tekan  untuk memilih.
Layar menampilkan entri sesuai urutan abjad.
-

- 3 Tekan  atau  ke alias atau ID subscriber yang diinginkan. Baris pertama layar menampilkan Nomor Telepon:. Baris kedua layar menampilkan kursor yang berkedip. Gunakan keypad untuk memasukkan nomor telepon.
-



- 4 Tekan  untuk memilih. Jika entri yang dipilih kosong, nada indikator negatif akan berbunyi dan layar menampilkan Panggilan Telepon Tidak Valid #.
-

- 5 Tekan  atau  ke Panggil Telepon dan Tekan  untuk memilih. Jika kode akses tidak dikonfigurasi sebelumnya dalam daftar Kontak, baris pertama pada layar menampilkan Kode Akses:. Baris kedua layar menampilkan kursor yang berkedip. Masukkan kode akses dan tekan tombol  untuk melanjutkan. Jika berhasil, nada DTMF

terdengar. Nada panggilan dari pengguna telepon akan terdengar. Baris pertama layar menampilkan alias atau ID subscriber, dan ikon **RSSI**. Baris kedua layar menampilkan Panggilan Telepon dan ikon **Panggilan Telepon**. Jika tidak berhasil, nada terdengar dan layar menampilkan Panggilan Telepon Gagal. Radio Anda kembali ke layar input Kode Akses. Jika kode akses telah dikonfigurasi sebelumnya di daftar Kontak, radio akan kembali ke layar tempat Anda berada sebelum memulai panggilan.

-
- 6 Tekan tombol **PTT** untuk berbicara dan lepaskan untuk mendengarkan. Ikon **RSSI** tidak ditampilkan selama transmisi.
-
- 7 Untuk memasukkan digit ekstra, jika diminta oleh Panggilan Telepon, lakukan salah satu hal berikut.
- Tekan sembarang tombol keypad untuk mulai memasukkan digit ekstra. Baris pertama layar menampilkan Digit Ekstra:. Baris kedua layar menampilkan kursor yang berkedip. Masukkan digit ekstra dan tekan tombol  untuk melanjutkan. Nada DTMF terdengar dan radio kembali ke layar sebelumnya.

- Tekan tombol **Akses Satu Sentuhan**. Nada DTMF akan berbunyi. Jika entri untuk tombol **Akses Satu Sentuhan** kosong, nada indikator negatif akan berbunyi.

-
- 8 Tekan  untuk mengakhiri panggilan. Jika kode de-akses tidak dikonfigurasi sebelumnya dalam daftar Kontak, baris pertama layar akan menampilkan Kode De-Akses:. Baris kedua layar menampilkan kursor yang berkedip. Masukkan kode de-akses dan tekan  untuk melanjutkan. Radio kembali ke layar sebelumnya. Nada DTMF berbunyi dan layar menampilkan Mengakhiri Panggilan Telepon. Jika berhasil, nada terdengar dan layar menampilkan Panggilan Telepon Diakhiri. Radio Anda kembali ke layar Panggilan Telepon. Jika tidak berhasil, radio Anda kembali ke layar Panggilan Telepon. Jika Anda menekan tombol **PTT** saat berada di layar Kontak Telepon, nada akan berbunyi dan layar menampilkan Tekan OK untuk Melakukan Panggilan. Jika pengguna telepon mengakhiri panggilan, nada berbunyi dan layar menampilkan dan layar menampilkan Panggilan Telepon Diakhiri. Jika panggilan berakhir saat Anda memasukkan digit ekstra yang diminta oleh

Panggilan Telepon, radio kembali ke layar yang dibuka sebelum Anda memulai panggilan.



- 9 Panggilan berakhir jika tidak ada aktivitas suara selama waktu yang telah ditentukan. Anda akan mendengar nada pendek. Layar menampilkan pesan **Panggilan Diakhiri**.

Pemanggil dan penerima panggilan dapat memutus Panggilan Pribadi yang sedang berlangsung dengan menekan .



PEMBERITAHUAN:

Selama akses saluran, tekan  untuk menghentikan percobaan panggilan dan nada akan berbunyi atau untuk keluar dari pencarian alias.

Tekan tombol  atau  untuk keluar dari pencarian alias. Selama panggilan, saat Anda menekan tombol **Akses Satu Sentuhan** dengan kode de-akses yang dikonfigurasi sebelumnya atau memasukkan kode de-akses sebagai input untuk digit ekstra, radio akan mencoba mengakhiri panggilan.

Melakukan Panggilan Pribadi dengan Tombol Panggilan Satu Sentuhan

Fitur Panggilan Satu Sentuhan memungkinkan Anda untuk melakukan Panggilan Pribadi dengan mudah ke alias Panggilan Pribadi atau ID yang sudah ditentukan. Fitur ini dapat ditetapkan untuk tombol yang dapat diprogram dengan menekan singkat atau lama.

Anda hanya dapat menetapkan satu alias atau ID ke tombol Panggilan Satu Sentuhan. Radio Anda dapat memiliki beberapa tombol Panggilan Satu Sentuhan yang diprogram.

- 1 Tekan tombol **Panggilan Satu Sentuhan** untuk melakukan Panggilan Pribadi ke alias atau ID Panggilan Pribadi yang telah ditentukan sebelumnya.
 - 2 Tekan tombol **PTT** untuk melakukan panggilan. Lampu LED menyala hijau tak berkedip. Layar akan menampilkan alias atau ID Panggilan Pribadi.
-

3 Tunggu hingga Nada Izin Bicara selesai (jika diaktifkan) dan bicaralah dengan jelas ke mikrofon.

4 Lepaskan tombol **PTT** untuk mendengarkan.

Ketika radio target menjawab, LED berkedip hijau.

Jika tidak ada aktivitas suara selama jangka waktu yang telah ditentukan, panggilan akan berakhir.

Pemanggil dan penerima panggilan dapat memutus Panggilan Pribadi yang sedang berlangsung dengan

menekan .

Melakukan Panggilan Pribadi Menggunakan Panggilan Manual

Ikuti prosedur untuk melakukan Panggilan Pribadi di radio Anda menggunakan panggilan manual.

1 Tekan  untuk mengakses menu.

2 Tekan  atau  ke Kontak. Tekan  untuk memilih.



3 Tekan  atau  ke Panggilan Manual.

Tekan  untuk memilih.

4 Tekan  atau  ke Nomor Radio. Tekan

 untuk memilih.

5 Lakukan salah satu langkah berikut:

- Masukkan ID subscriber, lalu tekan  untuk melanjutkan.
 - Edit ID subscriber yang dipanggil sebelumnya, lalu tekan  untuk melanjutkan.
-

6 Tekan tombol **PTT** untuk melakukan panggilan. LED hijau akan menyala. Layar menampilkan alias tujuan.

7 Tunggu hingga Nada Izin Bicara selesai dan bicaralah dengan jelas ke mikrofon, jika diaktifkan.

- 8 Lepaskan tombol **PTT** untuk mendengarkan.
LED hijau akan menyala jika radio target merespons. Layar akan menampilkan alias atau ID pengguna yang melakukan transmisi.

- 9 Jika fitur Indikasi Saluran Bebas diaktifkan, nada peringatan singkat akan berbunyi saat pengguna radio yang melakukan transmisi melepaskan tombol **PTT**, yang menunjukkan saluran bebas dapat Anda gunakan untuk merespons. Tekan tombol **PTT** untuk menjawab panggilan.

Panggilan berakhir jika tidak ada aktivitas suara selama waktu yang telah ditentukan. Nada akan berbunyi. Layar menampilkan pesan **Panggilan Diakhiri**.

Pemanggil dan penerima panggilan dapat memutus Panggilan Pribadi yang sedang berlangsung dengan menekan .

Menerima Panggilan Pribadi

Bila menerima Panggilan Pribadi yang dikonfigurasi sebagai Penyiapan Panggilan Off Air (OACSU):

- LED akan berkedip hijau.
- Radio bersuara dan panggilan masuk berbunyi melalui speaker.





PEMBERITAHUAN:

Tergantung bagaimana radio Anda dikonfigurasi, apakah OACSU atau Penyiapan Panggilan Off Air Penuh (FOACSU), merespons Panggilan Pribadi mungkin memerlukan respons pengguna atau tidak.

Untuk konfigurasi OACSU, radio Anda tidak mematikan suara dan panggilan terhubung secara otomatis.

Menerima Panggilan Pribadi

Bila menerima Panggilan Pribadi yang dikonfigurasi sebagai Penyiapan Panggilan Off Air Penuh (FOACSU):

- LED akan berkedip hijau.
- 1 Untuk menerima Panggilan Pribadi yang dikonfigurasi sebagai FOACSU, lakukan salah satu hal berikut:
 - Tekan  atau  ke **Terima** dan tekan  untuk menjawab Panggilan Pribadi.

- Tekan tombol **PTT** pada entri apa pun. LED hijau akan menyala.

2 Tunggu hingga Nada Izin Bicara selesai dan bicaralah dengan jelas ke mikrofon, jika diaktifkan.

3 Lepaskan tombol **PTT** untuk mendengarkan.

Panggilan berakhir jika tidak ada aktivitas suara selama waktu yang telah ditentukan. Nada akan berbunyi. Layar menampilkan pesan Panggilan Diakhiri.



PEMBERITAHUAN:





Pemanggil dan penerima panggilan dapat memutus Panggilan Pribadi yang sedang berlangsung dengan menekan .

Menolak Panggilan Pribadi

Bila menerima Panggilan Pribadi yang dikonfigurasi sebagai Penyiapan Panggilan Off Air Penuh (FOACSU):

- LED akan berkedip hijau.

Untuk menolak Panggilan Pribadi yang dikonfigurasi sebagai FOACSU, lakukan salah satu hal berikut:

- Tekan  atau  ke Tolak dan tekan  untuk menolak Panggilan Pribadi.
- Tekan  untuk menolak Panggilan Pribadi.

Semua Panggilan

Semua Panggilan adalah panggilan dari radio individu ke setiap radio di site atau setiap radio di sekelompok site, tergantung konfigurasi sistemnya.

Semua Panggilan digunakan untuk melakukan pengumuman penting yang memerlukan perhatian penuh dari pengguna. Pengguna pada sistem ini tidak dapat merespons Semua Panggilan.

Capacity Max mendukung Semua Panggilan Site dan Semua Panggilan Multisite. Administrator sistem dapat mengonfigurasi salah satu atau keduanya di radio Anda.



PEMBERITAHUAN:

Subscriber dapat mendukung Semua Panggilan Tingkat Sistem, tetapi infrastruktur Motorola Solutions tidak mendukung Semua Panggilan Tingkat Sistem.

Melakukan Semua Panggilan

Radio harus diprogram sebelum Anda dapat melakukan Semua Panggilan. Ikuti prosedur untuk melakukan Semua Panggilan di radio Anda.

- 1 Pilih saluran dengan ID atau alias grup Semua Panggilan yang aktif. Lihat [Memilih Jenis Panggilan di halaman 63](#).
- 2 Tekan tombol **PTT** untuk melakukan panggilan. LED hijau akan menyala. Layar menampilkan ikon **Panggilan Grup** dan Semua Panggilan, Semua Panggilan Site, atau Panggilan Multisite tergantung jenis konfigurasinya.
- 3 Lakukan salah satu langkah berikut:

- Tunggu hingga Nada Izin Bicara selesai dan bicaralah dengan jelas ke mikrofon, jika diaktifkan.
- Tunggu hingga Sidetone **PTT** selesai dan bicaralah dengan jelas ke mikrofon, jika diaktifkan.

Pengguna pada saluran ini tidak bisa menjawab Semua Panggilan.

Inisiator panggilan dapat menekan  untuk mengakhiri Semua Panggilan.

Melakukan Semua Panggilan Menggunakan Tombol Angka yang Dapat Diprogram

Ikuti prosedur untuk melakukan Semua Panggilan di radio Anda menggunakan tombol angka yang dapat diprogram.

- 1 Tekan lama tombol angka terprogram yang dialokasikan ke alias atau ID yang telah ditentukan ketika Anda berada di layar Awal.
Jika sebuah tombol angka dialokasikan untuk sebuah entri dalam mode tertentu, fitur ini tidak

didukung apabila Anda menekan lama tombol angka dalam mode yang lain.

Nada indikator negatif akan terdengar jika tombol angka tidak berhubungan dengan sebuah entri.

2 Tekan tombol **PTT** untuk melakukan panggilan.

LED hijau akan menyala. Layar menampilkan ikon **Panggilan Grup** dan Semua Panggilan, Semua Panggilan Site, atau Panggilan Multisite tergantung jenis konfigurasinya.

3 Lakukan salah satu langkah berikut:

- Tunggu hingga Nada Izin Bicara selesai dan bicaralah dengan jelas ke mikrofon, jika diaktifkan.
- Tunggu hingga Sidetone **PTT** selesai dan bicaralah dengan jelas ke mikrofon, jika diaktifkan.

Inisiator panggilan dapat menekan  untuk mengakhiri Semua Panggilan.



Lihat [Megalokasikan Entri ke Tombol Angka yang Dapat Diprogram di halaman 423](#) untuk informasi selengkapnya.

Melakukan Semua Panggilan Menggunakan Pencarian Alias

1 Tekan  untuk mengakses menu.

2 Tekan  atau  ke Kontak. Tekan  untuk memilih.

Layar menampilkan entri sesuai urutan abjad.

3 Tekan  atau  ke alias atau ID subscriber yang diinginkan. Baris pertama layar menampilkan Nomor Telepon:. Baris kedua layar menampilkan kursor yang berkedip. Gunakan keypad untuk memasukkan nomor telepon.

4 Tekan  untuk memilih. Jika entri yang dipilih kosong, nada indikator negatif akan berbunyi dan layar menampilkan Panggilan Telepon Tidak Valid #.

5 Tekan  atau  ke Panggilan Telepon.



Tekan  untuk memilih. Jika kode akses tidak dikonfigurasi sebelumnya dalam daftar Kontak, baris pertama layar akan menampilkan Kode Akses:. Baris kedua layar menampilkan kursor yang berkedip. Masukkan kode akses dan tekan tombol

 untuk melanjutkan. Jika berhasil, nada DTMF terdengar. Nada panggilan dari pengguna telepon akan terdengar. Baris pertama layar menampilkan alias atau ID subscriber, dan ikon RSSI. Baris kedua layar menampilkan Panggil Telepon dan ikon Panggilan Telepon. Jika tidak berhasil, nada terdengar dan layar menampilkan Panggilan Telepon Gagal. Radio Anda kembali ke layar input Kode Akses. Jika kode akses telah dikonfigurasi sebelumnya di daftar Kontak, radio akan kembali ke layar tempat Anda berada sebelum memulai panggilan.

6 Tekan tombol **PTT** untuk berbicara dan lepaskan untuk mendengarkan. Ikon RSSI tidak ditampilkan selama transmisi.

7 Untuk memasukkan digit ekstra, jika diminta oleh Panggilan Telepon, lakukan salah satu hal berikut.

- Tekan sembarang tombol keypad untuk mulai memasukkan digit ekstra. Baris pertama layar menampilkan Digit Ekstra:. Baris kedua layar menampilkan kursor yang berkedip. Masukkan digit ekstra dan tekan tombol  untuk melanjutkan. Nada DTMF terdengar dan radio kembali ke layar sebelumnya.
- Tekan tombol **Akses Satu Sentuhan**. Nada DTMF akan berbunyi. Jika entri untuk tombol **Akses Satu Sentuhan** kosong, nada indikator negatif akan berbunyi.

8 Tekan  untuk mengakhiri panggilan. Jika kode de-akses tidak dikonfigurasi sebelumnya dalam daftar Kontak, baris pertama layar akan menampilkan Kode De-Akses:. Baris kedua layar menampilkan kursor yang berkedip. Masukkan kode de-akses dan tekan  untuk melanjutkan. Radio kembali ke layar sebelumnya. Nada DTMF berbunyi dan layar menampilkan Mengakhiri Panggilan Telepon. Jika berhasil, nada terdengar dan layar

menampilkan Panggilan Telepon Diakhiri. Radio Anda kembali ke layar Panggilan Telepon. Jika tidak berhasil, radio Anda kembali ke layar Panggilan Telepon. Jika Anda menekan tombol **PTT** saat berada di layar Kontak Telepon, nada akan berbunyi dan layar menampilkan Tekan OK untuk Melakukan Panggilan. Jika pengguna telepon mengakhiri panggilan, nada berbunyi dan layar menampilkan dan layar menampilkan Panggilan Telepon Diakhiri. Jika panggilan berakhir saat Anda memasukkan digit ekstra yang diminta oleh Panggilan Telepon, radio kembali ke layar yang dibuka sebelum Anda memulai panggilan.



PEMBERITAHUAN:

Inisiator panggilan dapat menekan  untuk mengakhiri Semua Panggilan.

Menerima Semua Panggilan

Bila Anda menerima Semua Panggilan, hal berikut akan terjadi:

- Nada akan berbunyi.
- LED akan berkedip hijau.

- Layar menampilkan ikon **Panggilan Grup** di sudut kanan atas.
- Baris teks pertama menampilkan ID alias pemanggil.
- Baris teks kedua menampilkan Semua Panggilan, Semua Panggilan Site, atau Panggilan Multisite tergantung pada jenis konfigurasi.
- Radio bersuara dan panggilan masuk berbunyi melalui speaker.

Ketika panggilan berakhir, radio kembali ke layar sebelum menerima Semua Panggilan.

Jika fitur Indikasi Saluran Bebas diaktifkan, Anda akan mendengar nada peringatan singkat pada saat radio yang melakukan transmisi melepaskan tombol **PTT**, yang menunjukkan bahwa saluran sudah bebas untuk Anda gunakan. Anda tidak bisa menjawab Semua Panggilan.



PEMBERITAHUAN:

Radio berhenti menerima Semua Panggilan jika Anda beralih ke saluran lain ketika menerima panggilan tersebut. Selama Semua Panggilan, Anda tidak dapat melanjutkan navigasi menu atau mengedit sampai panggilan berakhir.

Panggilan Telepon

Panggilan Telepon adalah panggilan antara radio individual atau sekelompok radio dan sebuah telepon.

Tergantung pada bagaimana radio dikonfigurasi, fitur berikut mungkin bisa disediakan atau tidak:

- Nada Dual Tone Multi Frequency (DTMF)
- Kode de-akses
- Menampilkan alias pemanggil atau ID saat menerima panggilan telepon
- Kemampuan untuk menolak atau menerima panggilan telepon

Kemampuan Panggilan Telepon dapat diaktifkan dengan menetapkan dan menyiapkan nomor telepon di sistem.

Tanyakan kepada administrator sistem Anda untuk mengetahui bagaimana radio Anda diprogram.

Melakukan Panggilan Telepon

Ikuti prosedur untuk melakukan Panggilan Telepon di radio Anda.

- 1 Tekan tombol **Akses Satu Sentuhan** terprogram ke alias atau ID yang telah ditentukan.

Jika entri untuk tombol **Akses Satu Sentuhan** kosong, nada indikator negatif akan berbunyi.

Jika kode akses tidak dikonfigurasi sebelumnya dalam Daftar Kontak, layar akan menampilkan Kode Akses:.

- 2 Masukkan kode akses, lalu tekan  untuk melanjutkan.

Kode akses atau de-akses tidak boleh lebih dari 10 karakter.

- 3 Tekan tombol **PTT** untuk menjawab panggilan.
-

- 4 Lepaskan tombol **PTT** untuk mendengarkan.
-

- 5 Masukkan digit ekstra dengan keypad jika diminta oleh panggilan, lalu tekan  untuk melanjutkan.

Jika panggilan berakhir saat Anda memasukkan digit ekstra yang diminta oleh panggilan, radio kembali ke layar yang dibuka sebelum Anda memulai panggilan.

Nada DTMF akan berbunyi. Radio kembali ke layar sebelumnya.

6 Tekan  untuk mengakhiri panggilan.

7 Lakukan salah satu langkah berikut:

- Jika kode de-akses belum dikonfigurasi, masukkan kode de-akses ketika layar menampilkan Kode De-Akses:, lalu tekan  untuk melanjutkan. Radio kembali ke layar sebelumnya.
- Tekan tombol **Akses Satu Sentuhan** terprogram. Jika entri untuk tombol **Akses Satu Sentuhan** kosong, nada indikator negatif akan berbunyi.

Nada DTMF berbunyi dan layar menampilkan

Mengakhiri Panggilan Telepon.

Jika panggilan berhasil diakhiri:



- Nada akan berbunyi.

- Layar menampilkan pesan Panggilan Diakhiri.

Jika panggilan tidak berhasil diakhiri, radio kembali ke layar Panggilan Telepon. Ulangi dua langkah terakhir atau tunggu hingga pengguna telepon mengakhiri panggilan.

Melakukan Panggilan Telepon dengan Tombol yang Dapat Diprogram

Ikuti prosedur untuk melakukan Panggilan Telepon dengan tombol yang dapat diprogram.

- 1 Tekan tombol **Telepon** terprogram untuk masuk ke daftar Entri Telepon.
- 2 Tekan  atau  ke alias atau ID yang diinginkan. Tekan  untuk memilih.

Jika kode akses tidak dikonfigurasi sebelumnya dalam daftar Kontak, layar akan menampilkan Kode

Akses: . Masukkan kode akses dan tekan tombol



untuk melanjutkan.

LED hijau akan menyala. Layar menampilkan ikon **Panggilan Telepon**, alias subscriber atau ID, dan status panggilan.

Jika penyiapan-panggilan berhasil:

- Nada DTMF akan berbunyi.
- Nada tunggu panggilan dari pengguna telepon akan terdengar.
- Layar menampilkan ikon **Panggilan Telepon**, alias subscriber atau ID, Panggilan Telepon, dan status panggilan.

Jika penyiapan-panggilan tidak berhasil:

- Nada akan berbunyi.
- Layar menampilkan Panggilan Telepon Gagal.
- Radio Anda kembali ke layar input Kode Akses. Jika kode akses telah dikonfigurasi sebelumnya di daftar Kontak, radio akan kembali ke layar tempat Anda berada sebelum memulai panggilan.

3 Tekan tombol **PTT** untuk berbicara. Lepaskan tombol **PTT** untuk mendengarkan. Ikon RSSI tidak ditampilkan selama transmisi.

4 Untuk memasukkan digit ekstra, jika diminta oleh Panggilan Telepon. Lakukan salah satu langkah berikut:

- Tekan sembarang tombol keypad untuk mulai memasukkan digit ekstra. Layar menampilkan **Digit Ekstra:** dan kursor berkedip. Masukkan digit ekstra dan tekan tombol  untuk melanjutkan. Nada DTMF terdengar dan radio kembali ke layar sebelumnya.
- Tekan tombol **Akses Satu Sentuhan**. Nada DTMF akan berbunyi. Jika entri untuk tombol **Akses Satu Sentuhan** kosong, nada indikator negatif akan berbunyi.

5 Tekan  untuk mengakhiri panggilan.

Jika kode de-akses tidak dikonfigurasi sebelumnya dalam daftar Kontak, layar akan menampilkan Kode-

De Akses: Masukkan kode de-akses dan tekan tombol  untuk melanjutkan.

Nada DTMF berbunyi dan layar menampilkan Mengakhiri Panggilan Telepon.

Jika pengaturan akhiri panggilan berhasil, nada terdengar dan layar menampilkan Panggilan Diakhiri.

Jika pengaturan akhiri panggilan tidak berhasil, radio Anda kembali ke layar Panggilan Telepon.

Saat Anda menekan tombol **PTT** ketika berada di layar Kontak Telepon, nada akan berbunyi dan layar menampilkan Tekan OK untuk Melakukan Panggilan.

Jika pengguna telepon mengakhiri panggilan, nada berbunyi dan layar menampilkan Panggilan Telepon Diakhiri.

Jika panggilan berakhir saat Anda memasukkan digit ekstra yang diminta oleh Panggilan Telepon, radio kembali ke layar yang dibuka sebelum Anda memulai panggilan.



PEMBERITAHUAN:

Selama akses saluran, tekan  untuk menghentikan percobaan panggilan dan nada akan berbunyi.



Selama panggilan, saat Anda menekan tombol **Akses Satu Sentuhan** dengan kode de-akses yang dikonfigurasi sebelumnya atau memasukkan kode de-akses sebagai input untuk digit ekstra, radio akan mencoba mengakhiri panggilan.



Selama akses saluran dan kode akses/de-akses atau transmisi digit ekstra, radio Anda hanya merespons tombol **Aktif/Nonaktif**, **Volume Aktif/Nonaktif Kenop Volume**, dan **Saluran Naik/Turun Pemilih Saluran** saja. Nada akan berbunyi untuk tiap input yang tidak valid.

Melakukan Panggilan Telepon Menggunakan Daftar Kontak

Ikuti prosedur untuk melakukan Panggilan Telepon di radio Anda menggunakan daftar Kontak.

1 Tekan  untuk mengakses menu.

2 Tekan  atau  ke Kontak. Tekan  untuk memilih.
Layar menampilkan entri sesuai urutan abjad.

3 Tekan  atau  ke alias atau ID yang diinginkan. Tekan  untuk memilih.
Jika Anda menekan tombol **PTT** ketika berada di layar Kontak Telepon:

- Nada indikator negatif akan berbunyi.
- Layar menampilkan Tekan OK untuk Melakukan Panggilan.

Jika entri yang dipilih kosong:

- Nada indikator negatif akan berbunyi.
 - Layar menampilkan pesan Panggilan Telepon Tidak Valid #.
-

4 Tekan  atau  ke Panggilan Telepon.

Tekan  untuk memilih.

Layar menampilkan Kode Akses: jika kode akses tidak dikonfigurasi di awal.

5 Masukkan kode akses, lalu tekan  untuk melanjutkan.

Kode akses atau de-akses tidak boleh lebih dari 10 karakter.

Layar menampilkan ikon Memanggil, alias subscriber atau ID, dan **Panggilan Telepon**.
Jika panggilan berhasil:

- Nada DTMF akan berbunyi.
- Nada tunggu panggilan dari pengguna telepon akan terdengar.
- Layar menampilkan alias subscriber atau ID, ikon **Panggilan Telepon**, dan Panggilan Telepon.

Jika panggilan tidak berhasil:

- Nada akan berbunyi.

- Layar menampilkan Panggilan Telepon Gagal lalu, Kode Akses:.
- Radio kembali ke layar yang dibuka sebelum Anda memulai panggilan jika kode akses telah dikonfigurasi sebelumnya di daftar Kontak.

6 Tekan tombol **PTT** untuk menjawab panggilan. Ikon **RSSI** muncul.

7 Lepaskan tombol **PTT** untuk mendengarkan.

8 Masukkan digit ekstra dengan keypad jika diminta oleh panggilan, lalu tekan  untuk melanjutkan.

Jika panggilan berakhir saat Anda memasukkan digit ekstra yang diminta oleh panggilan, radio kembali ke layar yang dibuka sebelum Anda memulai panggilan.

Nada DTMF akan berbunyi. Radio kembali ke layar sebelumnya.

9 Tekan  untuk mengakhiri panggilan.

10 Jika kode de-akses belum dikonfigurasi, masukkan kode de-akses ketika layar menampilkan

Kode De-Akses:, lalu tekan  untuk melanjutkan.

Radio kembali ke layar sebelumnya. Nada DTMF berbunyi dan layar menampilkan Mengakhiri Panggilan Telepon.

Jika panggilan berhasil diakhiri:

- Nada akan berbunyi.
- Layar menampilkan pesan Panggilan Diakhiri.

Jika panggilan tidak berhasil diakhiri, radio kembali ke layar Panggilan Telepon. Ulangi [langkah 9](#) dan [langkah 10](#), atau tunggu hingga pengguna telepon mengakhiri panggilan. Jika Anda menekan tombol PTT saat berada di layar Kontak Telepon, nada akan berbunyi dan layar menampilkan Tekan OK untuk Melakukan Panggilan.

Jika pengguna telepon mengakhiri panggilan, nada berbunyi dan layar menampilkan dan layar menampilkan Phone Call Ended (Panggilan Telepon Diakhiri).

Jika panggilan berakhir saat Anda memasukkan digit ekstra yang diminta oleh Panggilan Telepon, radio kembali ke layar yang dibuka sebelum Anda memulai panggilan.



PEMBERITAHUAN:







Selama akses saluran, tekan  untuk menghentikan percobaan panggilan dan nada akan berbunyi.

Selama panggilan, saat Anda menekan tombol **Akses Satu Sentuhan** dengan kode de-akses yang dikonfigurasi sebelumnya atau memasukkan kode de-akses sebagai input untuk digit ekstra, radio akan mencoba mengakhiri panggilan.

Saat mengakses saluran dan melakukan transmisi kode akses/de-akses atau digit ekstra, radio hanya merespons tombol **On/Off**, **Kenop Volume**, dan **Pemilih Saluran**. Nada akan berbunyi untuk tiap input yang tidak valid.

Melakukan Panggilan Telepon Menggunakan Pencarian Alias

Anda juga dapat menggunakan pencarian alias atau alfanumerik untuk memperoleh alias subscriber yang diperlukan. Fitur ini hanya tersedia saat dalam Kontak. Ikuti prosedur untuk melakukan Panggilan Telepon di radio Anda menggunakan pencarian alias.

- 1 Tekan  untuk mengakses menu.
- 2 Tekan  atau  ke Kontak. Tekan  untuk memilih.
Layar menampilkan entri sesuai urutan abjad.
- 3 Tekan  atau  ke alias atau ID subscriber yang diinginkan.
- 4 Tekan  untuk memilih. Jika entri yang dipilih kosong, nada indikator negatif akan berbunyi dan layar menampilkan Phone Call Invalid # (Panggilan Telepon Tidak Valid #).

5 Tekan  atau  ke Panggilan Telepon.

Tekan  untuk memilih.

Jika kode akses tidak dikonfigurasi sebelumnya dalam daftar Kontak, layar akan menampilkan Kode Akses: dan kursor yang berkedip. Masukkan kode

akses dan tekan tombol  untuk melanjutkan.

Jika berhasil:

- Nada DTMF akan berbunyi.
- Nada tunggu panggilan dari pengguna telepon akan terdengar.
- Layar menampilkan alias subscriber atau ID, ikon **RSSI**, Panggilan Telepon, dan **Panggilan Telepon**.

Jika tidak berhasil:

- Nada akan berbunyi.
- Layar menampilkan pesan Panggilan Telepon Gagal.
- Radio Anda kembali ke layar input Kode Akses. Jika kode akses telah dikonfigurasi sebelumnya di daftar Kontak, radio akan kembali ke layar

tempat Anda berada sebelum memulai panggilan.

6 Tekan tombol **PTT** untuk berbicara dan lepaskan untuk mendengarkan. Ikon **RSSI** tidak ditampilkan selama transmisi.

7 Untuk memasukkan digit ekstra, jika diminta oleh Panggilan Telepon, lakukan salah satu hal berikut.

- Tekan sembarang tombol keypad untuk mulai memasukkan digit ekstra. Layar menampilkan Digit Ekstra: dan kursor berkedip. Masukkan digit ekstra dan tekan tombol  untuk melanjutkan. Nada DTMF akan berbunyi
 - Tekan tombol **Akses Satu Sentuhan**. Nada DTMF akan berbunyi. Jika entri untuk tombol **Akses Satu Sentuhan** kosong, nada indikator negatif akan berbunyi dan radio kembali ke layar sebelumnya.
-

8 Tekan  untuk mengakhiri panggilan.

Jika kode de-akses tidak dikonfigurasi sebelumnya dalam daftar Kontak, layar akan menampilkan Kode-

De Akses: dan kursor yang berkedip. Masukkan kode de-akses dan tekan  untuk melanjutkan.

Radio kembali ke layar sebelumnya. Nada DTMF berbunyi dan layar menampilkan Ending Phone Call (Mengakhiri Panggilan Telepon).

Jika berhasil:

- Nada akan berbunyi.
- Layar menampilkan pesan Panggilan Telepon Diakhiri.
- Radio Anda kembali ke layar Panggilan Telepon.

Jika tidak berhasil:



- Radio Anda kembali ke layar Panggilan Telepon.
- Jika Anda menekan tombol **PTT** saat berada di layar Kontak Telepon, nada akan berbunyi dan layar menampilkan Tekan OK untuk Melakukan Panggilan.
- Jika pengguna telepon mengakhiri panggilan, nada berbunyi dan layar menampilkan dan layar menampilkan Phone Call Ended (Panggilan Telepon Diakhiri).
- Jika panggilan berakhir saat Anda memasukkan digit ekstra yang diminta oleh Panggilan Telepon,

radio kembali ke layar yang dibuka sebelum Anda memulai panggilan.



PEMBERITAHUAN:



Selama akses saluran, tekan  untuk menghentikan percobaan panggilan dan nada akan berbunyi atau untuk keluar dari pencarian alias.



Tekan tombol  atau  untuk keluar dari pencarian alias. Selama panggilan, saat Anda menekan tombol **Akses Satu Sentuhan** dengan kode de-akses yang dikonfigurasi sebelumnya atau memasukkan kode de-akses sebagai input untuk digit ekstra, radio akan mencoba mengakhiri panggilan. Saat mengakses saluran dan melakukan transmisi kode akses/de-akses atau digit ekstra, radio hanya merespons tombol On/Off, Kenop Volume, dan Pemilih Saluran. Nada akan berbunyi untuk tiap input yang tidak valid.



Melakukan Panggilan Telepon Menggunakan Panggilan Manual

Ikuti prosedur untuk melakukan Panggilan Telepon di radio Anda menggunakan panggilan manual.

- 1 Tekan  untuk mengakses menu.

- 2 Tekan  atau  ke Kontak. Tekan  untuk memilih.

- 3 Tekan  atau  ke Panggilan Manual. Tekan  untuk memilih.

- 4 Tekan  atau  ke Nomor Telepon. Tekan  untuk memilih.
Layar menampilkan Nomor: dan kursor berkedip.

- 5 Masukkan nomor telepon, lalu tekan  untuk melanjutkan.
Layar menampilkan Kode Akses: dan kursor berkedip jika kode akses belum dikonfigurasi.

- 6 Masukkan kode akses, lalu tekan  untuk melanjutkan. Kode akses atau de-akses tidak boleh lebih dari 10 karakter.
LED hijau akan menyala. Layar menampilkan ikon **Panggilan Telepon**, alias subscriber, dan status panggilan.
Jika panggilan berhasil:
 - Nada DTMF akan berbunyi.
 - Nada tunggu panggilan dari pengguna telepon akan terdengar.
 - Layar menampilkan alias subscriber dan ikon **Panggilan Telepon**.
 Jika panggilan tidak berhasil:
 - Nada akan berbunyi.
 - Layar menampilkan Panggilan Telepon Gagal lalu, Kode Akses:.
 - Radio kembali ke layar yang dibuka sebelum memulai panggilan jika kode akses telah dikonfigurasi sebelumnya di daftar Kontak.
-

7 Tekan  untuk mengakhiri panggilan.

8 Lakukan salah satu langkah berikut:

- Jika kode de-akses belum dikonfigurasi, masukkan kode de-akses ketika layar menampilkan Kode De-Akses:, lalu tekan  untuk melanjutkan. Radio kembali ke layar sebelumnya.
- Tekan tombol **Akses Satu Sentuhan** terprogram. Jika entri untuk tombol **Akses Satu Sentuhan** kosong, nada indikator negatif akan berbunyi.

Nada DTMF berbunyi dan layar menampilkan Mengakhiri Panggilan Telepon.

Jika panggilan berhasil diakhiri:

- Nada akan berbunyi.
- Layar menampilkan pesan Panggilan Diakhiri.

Jika panggilan tidak berhasil diakhiri, radio kembali ke layar Panggilan Telepon. Ulangi [langkah 7](#), atau tunggu hingga pengguna telepon mengakhiri panggilan.



PEMBERITAHUAN:

Saat Anda menekan tombol **PTT** ketika berada di layar Kontak Telepon, nada akan berbunyi dan layar menampilkan **Tekan OK untuk Melakukan Panggilan**.



Saat pengguna telepon mengakhiri panggilan, nada akan berbunyi dan layar akan menampilkan **Panggilan Diakhiri**.

Jika panggilan berakhir saat Anda memasukkan digit ekstra yang diminta oleh Panggilan Telepon, radio kembali ke layar yang dibuka sebelum Anda memulai panggilan.

Selama akses saluran, tekan  untuk menghentikan percobaan panggilan dan nada akan berbunyi.

Selama panggilan, saat Anda menekan tombol **Akses Satu Sentuhan** dengan kode de-akses yang dikonfigurasi sebelumnya atau memasukkan kode de-akses sebagai input untuk digit ekstra, radio akan mencoba mengakhiri panggilan.

Saat mengakses saluran dan melakukan transmisi kode akses/de-akses atau digit ekstra, radio hanya merespons tombol **On/Off**, **Kenop Volume**, dan **Pemilih Saluran**. Nada akan berbunyi untuk tiap input yang tidak valid.

- Masukkan nomor yang diinginkan untuk memulai panggilan DTMF.
- Tekan  untuk memulai panggilan DTMF.
- Tekan  untuk memulai panggilan DTMF.

Multi Frekuensi Dual Tone

Fitur Multi Frekuensi Dual Tone (DTMF) memungkinkan radio beroperasi dalam sistem radio dengan antarmuka ke sistem telepon.

Anda dapat mematikan nada DTMF dengan menonaktifkan semua nada dan peringatan radio. Lihat [Mengaktifkan atau Menonaktifkan Nada/Peringatan Radio di halaman 208](#) untuk informasi selengkapnya.

Memulai Panggilan DTMF

Ikuti prosedur untuk memulai panggilan DTMF di radio Anda.

- 1 Tekan dan tahan tombol **PTT**.
- 2 Lakukan salah satu langkah berikut:

Merespons Panggilan Telepon sebagai Semua Panggilan

Saat Anda menerima Panggilan Telepon sebagai Semua Panggilan, radio penerima tidak dapat melakukan talkback atau merespons. Pengguna penerima juga tidak diizinkan mengakhiri Semua Panggilan.

Saat menerima Panggilan Telepon sebagai Semua Panggilan:

- Layar menampilkan ikon **Panggilan Telepon** di sudut kanan atas.
- Layar menampilkan Semua Panggilan, Semua Panggilan Site, atau Panggilan Multisite tergantung pada jenis konfigurasi dan Panggilan Telepon.
- LED akan berkedip hijau.

- Radio bersuara dan panggilan masuk berbunyi melalui speaker.

Merespons Panggilan Telepon sebagai Panggilan Grup

Ikuti prosedur untuk merespons Panggilan Telepon sebagai Panggilan Grup di radio Anda.

Saat menerima Panggilan Telepon sebagai Panggilan Grup:

- Layar menampilkan ikon **Panggilan Telepon** dan Panggilan Telepon.
- LED akan berkedip hijau.
- Radio bersuara dan panggilan masuk berbunyi melalui speaker.

1 Tekan tombol **PTT** untuk menjawab panggilan.

2 Lepaskan tombol **PTT** untuk mendengarkan.

3 Tekan  untuk mengakhiri panggilan.



PEMBERITAHUAN:

Radio Anda tidak dapat menghentikan panggilan telepon sebagai panggilan grup. Pengguna telepon yang harus mengakhiri panggilan. Pengguna penerima hanya diizinkan melakukan talkback selama panggilan.

Layar menampilkan Mengakhiri Panggilan Telepon.

Jika panggilan berhasil diakhiri:

- Nada akan berbunyi.
- Layar menampilkan pesan Panggilan Diakhiri.

Jika panggilan tidak berhasil diakhiri, radio kembali ke layar Panggilan Telepon. Ulangi [langkah 3](#) atau tunggu hingga pengguna telepon mengakhiri panggilan.

Merespons Panggilan Telepon sebagai Panggilan Pribadi

Ikuti prosedur untuk merespons Panggilan Telepon sebagai Panggilan Pribadi di radio Anda.

Saat menerima Panggilan Telepon sebagai Panggilan Pribadi:

- Layar menampilkan ikon **Panggilan Telepon** dan Panggilan Telepon.
- LED akan berkedip hijau.
- Radio bersuara dan panggilan masuk berbunyi melalui speaker.

1 Tekan tombol **PTT** untuk menjawab panggilan.

2 Lepaskan tombol **PTT** untuk mendengarkan.

3 Tekan  untuk mengakhiri panggilan.



PEMBERITAHUAN:

Radio Anda tidak dapat menghentikan panggilan telepon sebagai panggilan grup. Pengguna telepon yang harus mengakhiri panggilan. Pengguna penerima hanya diizinkan melakukan talkback selama panggilan.

Layar menampilkan Mengakhiri Panggilan Telepon.

Jika panggilan berhasil diakhiri:

- Nada akan berbunyi.
- Layar menampilkan pesan Panggilan Diakhiri.

Jika panggilan tidak berhasil diakhiri, radio kembali ke layar Panggilan Telepon. Ulangi [langkah 3](#) atau tunggu hingga pengguna telepon mengakhiri panggilan.

Penimpaan Panggilan

Penimpaan Panggilan memungkinkan radio menghentikan transmisi suara apa pun yang sedang berlangsung dan memulai transmisi prioritas.

Dengan fitur Penimpaan Panggilan, sistem menginterupsi dan menimpa panggilan yang sedang berlangsung pada kejadian dengan saluran trunking tersedia.

Panggilan dengan prioritas yang lebih tinggi, seperti Panggilan Darurat atau Semua Panggilan, menimpa radio yang melakukan transmisi untuk mengakomodasi panggilan dengan prioritas lebih tinggi. Jika tidak ada saluran Frekuensi Radio (RF) lain yang tersedia, Panggilan Darurat juga menimpa Semua Panggilan.

Interupsi Suara

Interupsi Suara memungkinkan pengguna mematikan transmisi suara yang sedang berlangsung.

Fitur ini menggunakan pensinyalan saluran balik untuk menghentikan transmisi suara yang sedang berlangsung dari sebuah radio, jika radio yang menginterupsi dikonfigurasi untuk Interupsi Suara, dan radio pemancar dikonfigurasi agar Dapat Diinterupsi Panggilan Suara. Kemudian radio yang menginterupsi diperbolehkan melakukan transmisi suara kepada peserta di panggilan yang dihentikan.

Fitur Interupsi Suara meningkatkan kemampuan pengiriman transmisi baru yang berhasil secara signifikan ke pihak yang dimaksud ketika panggilan berlangsung.

Interupsi Suara dapat diakses pengguna hanya jika fitur ini telah disiapkan di radio. Tanyakan kepada penyalur atau administrator sistem Anda untuk informasi lebih lanjut.

Mengaktifkan Interupsi Suara

Ikuti prosedur untuk memulai Interupsi Suara di radio Anda.

Radio harus diprogram agar Anda bisa menggunakan fitur ini. Tanyakan kepada penyalur atau administrator sistem Anda untuk informasi lebih lanjut.

- 1 Untuk menginterupsi transmisi selama panggilan berlangsung, tekan tombol **PTT**.

Pada radio yang diinterupsi, layar menampilkan **Panggilan Diinterupsi**. Radio membunyikan nada indikator negatif sampai tombol **PTT** dilepas.

- 2 Tunggu respons.

Jika berhasil:

- Nada indikator positif akan berbunyi.

Jika tidak berhasil:

- Nada indikator negatif akan berbunyi.
-

- 3 Lakukan salah satu langkah berikut:

- Tunggu hingga Nada Izin Bicara selesai dan bicaralah dengan jelas ke mikrofon, jika diaktifkan.
 - Tunggu hingga Sidetone **PTT** selesai dan bicaralah dengan jelas ke mikrofon, jika diaktifkan.
-

Fitur Lanjutan

Bab ini menjelaskan pengoperasian fitur-fitur yang terdapat di radio Anda.

Dealer atau administrator sistem mungkin telah mengatur radio sesuai dengan kebutuhan khusus Anda. Tanyakan kepada penyalur atau administrator sistem Anda untuk informasi lebih lanjut.

Antrean Panggilan

Bila tidak ada sumber daya yang tersedia untuk memproses panggilan, Antrean Panggilan memungkinkan permintaan panggilan ditempatkan di antrean sistem untuk sumber daya berikutnya yang tersedia.

Anda mendengar Nada Antrean Panggilan setelah menekan tombol **PTT** dan layar radio menampilkan Panggilan Dalam Antrean menunjukkan bahwa radio telah masuk ke dalam Status Antrean Panggilan. Tombol **PTT** dapat dilepas setelah Nada Antrean Panggilan terdengar.

Jika penyiapan panggilan berhasil, hal berikut akan terjadi:

- LED akan berkedip hijau.
- Jika diaktifkan, Nada Izin Bicara berbunyi.

- Layar menampilkan ikon jenis panggilan, ID, atau alias.
- Pengguna radio memiliki waktu hingga 4 detik untuk menekan tombol **PTT** untuk memulai transmisi suara.

Jika penyiapan panggilan tidak berhasil, hal berikut akan terjadi:

- Jika diaktifkan, Nada Penolakan berbunyi.
- Layar menampilkan pemberitahuan kegagalan selama beberapa saat.
- Panggilan diputus dan radio keluar dari penyiapan panggilan.

Panggilan Prioritas

Panggilan Prioritas memungkinkan sistem untuk menimpa salah satu dari panggilan non-prioritas yang sedang berlangsung dan memulai panggilan prioritas tinggi yang diminta saat semua saluran sedang sibuk.

Ketika semua saluran sedang penuh dengan panggilan prioritas tinggi, sistem tidak akan menimpa panggilan tersebut, dan menempatkan panggilan prioritas tinggi yang diminta ke antrean panggilan. Jika sistem gagal menempatkan panggilan prioritas tinggi yang diminta ke antrean, maka akan dinyatakan sebagai kegagalan.

Pengaturan default untuk Panggilan Prioritas telah dikonfigurasi sebelumnya. Tekan tombol yang dapat diprogram untuk beralih antara level prioritas normal dan tinggi. Saat Anda menggunakan fitur berikut, level panggilan prioritas kembali otomatis ke pengaturan yang dikonfigurasi sebelumnya.

- Semua panggilan suara
- Pesan Teks DMR III/Pesan Teks
- Tiket Tugas
- Monitor Jarak Jauh



PEMBERITAHUAN:

Tanyakan kepada dealer atau administrator sistem Anda untuk mengetahui bagaimana radio Anda diprogram.

Berikut ini adalah tipe Panggilan Prioritas:

Prioritas Tinggi

Radio menampilkan Panggilan Berikutnya:
Prioritas Tinggi.

Ikon **Panggilan Prioritas Tinggi** muncul di bagian atas layar radio.

Bunyi Pengumuman Suara Panggilan Berikutnya:
Prioritas Tinggi.

Prioritas Normal

Radio menampilkan Panggilan Berikutnya:
Prioritas Normal.

Ikon **Panggilan Prioritas Tinggi** menghilang.

Bunyi Pengumuman Suara Panggilan Berikutnya:
Prioritas Normal.

Pemindaian Grup Bicara

Fitur ini memungkinkan radio memantau dan menggabungkan panggilan untuk grup yang ditentukan oleh Daftar Grup Terima.

Jika aktif, ikon pemindaian akan muncul di bilah status dan LED akan berkedip dengan warna kuning. Radio mengaktifkan suara setiap anggota dalam Daftar Grup Terima.

Jika pemindaian nonaktif, radio tidak menerima transmisi dari anggota Daftar Grup Terima, kecuali untuk Semua Panggilan dan Grup Bicara yang dipilih.







PEMBERITAHUAN:







Pemindaian Grup Bicara dapat dikonfigurasi menggunakan CPS. Tanyakan kepada administrator sistem Anda untuk mengetahui bagaimana radio Anda diprogram.

Mengaktifkan atau Menonaktifkan Pemindaian Grup Bicara

Ikuti prosedur untuk mengaktifkan atau menonaktifkan Pemindaian Grup Bicara di radio Anda.

- 1 Tekan  **OK** untuk mengakses menu.

- 2 Tekan  atau  ke Pindai. Tekan  **OK** untuk memilih.

- 3 Lakukan salah satu langkah berikut:
 - Tekan  atau  ke Aktifkan. Tekan  **OK** untuk memilih.
 - Tekan  atau  ke Nonaktifkan. Tekan  **OK** untuk memilih.

Jika pemindaian diaktifkan:

- Layar menampilkan ikon Pemindaian Aktif dan **Pindai**.
- LED kuning akan berkedip.

- Nada indikator positif akan berbunyi.

Jika pemindaian dinonaktifkan:

- Layar akan menampilkan Pemindaian Nonaktif.
- Ikon **Pindai** tidak muncul.
- LED mati.
- Nada indikator negatif akan berbunyi.

Daftar Grup Terima

Daftar Grup Terima adalah fitur yang memungkinkan Anda membuat dan mengalokasikan anggota pada daftar pindai grup bicara.

Daftar ini dibuat saat radio diprogram dan daftar menentukan grup yang dapat dipindai. Radio Anda bisa mendukung maksimal 16 anggota di daftar tersebut.

Jika radio diprogram untuk mengizinkan pengeditan daftar pindai, Anda bisa:

- Menambah/menghapus grup bicara.
- Menambah, menghapus, dan/atau mengedit prioritas grup bicara. Baca [Mengedit Prioritas untuk Grup Bicara di halaman 107](#).

- Menambah, menghapus, dan/atau mengedit grup bicara afiliasi. Lihat [Menambahkan Afiliasi Grup Bicara di halaman 108](#) dan [Menghapus Afiliasi Grup Bicara di halaman 109](#).
- Mengganti daftar pindai yang ada dengan daftar pindai baru.



PENTING:

Untuk menambah anggota ke daftar, konfigurasi grup bicara di radio terlebih dahulu.



PEMBERITAHUAN:

Daftar Grup Terima diprogram oleh administrator sistem. Tanyakan kepada penyalur atau administrator sistem Anda untuk informasi lebih lanjut.

Monitor Prioritas

Fitur Monitor Prioritas membuat radio dapat menerima transmisi dari grup bicara secara otomatis dengan prioritas lebih tinggi jika radio sedang dalam grup bicara lain.

Radio mengakhiri panggilan grup bicara dengan prioritas yang lebih rendah agar dapat menerima panggilan grup bicara dengan prioritas lebih tinggi.



PEMBERITAHUAN:

Fitur ini hanya dapat diakses saat fitur Pindai Grup Bicara aktif.

Fitur Prioritas Minor hanya berlaku bagi anggota dalam Daftar Grup Terima. Terdapat dua Grup Bicara Prioritas: Prioritas 1 (P1) dan Prioritas 2 (P2). P1 mempunyai prioritas lebih tinggi daripada P2. Di sistem Maksimum Kapasitas, radio menerima transmisi sesuai dengan urutan prioritas berikut:

- 1 Panggilan Darurat untuk Grup Bicara P1
- 2 Panggilan Darurat untuk Grup Bicara P2
- 3 Panggilan Darurat untuk Grup Bicara non-prioritas dalam Daftar Grup Terima
- 4 Semua Panggilan
- 5 Panggilan Grup Bicara P1
- 6 Panggilan Grup Bicara P2
- 7 Grup Bicara Non-prioritas dalam Daftar Grup Terima

Lihat [Mengedit Prioritas untuk Grup Bicara di halaman 107](#) untuk informasi lebih lanjut mengenai cara menambahkan, menghapus, dan/atau mengedit prioritas grup bicara dalam daftar pindai.



**PEMBERITAHUAN:**



Fitur ini diprogram oleh administrator sistem. Tanyakan kepada penyalur atau administrator sistem Anda untuk informasi lebih lanjut.



Mengedit Prioritas untuk Grup Bicara

Di Menu Pemindaian Grup Bicara, Anda dapat melihat atau mengedit prioritas grup bicara.

- 1 Tekan  untuk mengakses menu.

- 2 Tekan  atau  ke Pindai. Tekan  untuk memilih.



- 3 Tekan  atau  ke Lihat/Edit Daftar. Tekan  untuk memilih.

- 4 Tekan  atau  ke grup bicara yang diinginkan. Tekan  untuk memilih.
Prioritas saat ini ditunjukkan dengan ikon **Prioritas 1** atau **Prioritas 2** di sebelah grup bicara.

- 5 Tekan  atau  ke Edit Prioritas. Tekan  untuk memilih.

- 6 Tekan  atau  ke tingkat prioritas yang diperlukan. Tekan  untuk memilih.

Jika grup bicara lain telah ditetapkan ke Prioritas 1 atau Prioritas 2, Anda dapat menimpa prioritas saat ini. Ketika layar menampilkan Timpa yang Sudah

Ada?, tekan  atau  pada opsi berikut:

- Tidak untuk kembali ke langkah sebelumnya.
- Ya untuk menimpa.

Layar menampilkan pemberitahuan mini positif sebelum kembali ke layar sebelumnya. Ikon prioritas muncul di sebelah grup bicara.

Afiliasi Multi Grup Bicara

Di sistem Maksimal Kapasitas, radio dapat dikonfigurasi untuk hingga tujuh grup bicara.

Dari 16 grup bicara di Daftar Grup Terima, Anda dapat menetapkan hingga tujuh grup bicara sebagai grup bicara afiliasi. Grup bicara yang dipilih dan grup bicara prioritas otomatis terafiliasi.







PEMBERITAHUAN:



Fitur ini diprogram oleh administrator sistem. Tanyakan kepada dealer atau administrator sistem Anda untuk informasi lebih lanjut.





Menambahkan Afiliasi Grup Bicara



Ikuti prosedur untuk menambahkan afiliasi grup bicara.







- 1 Tekan  untuk mengakses menu.

- 2 Tekan  atau  ke Pindai. Tekan  untuk memilih.

- 3 Tekan  atau  ke Lihat/Edit Daftar. Tekan  untuk memilih.

- 4 Tekan  atau  ke ID atau alias grup bicara yang diinginkan. Tekan  untuk memilih. Status afiliasi ditampilkan di Daftar Tampilkan/Edit. Layar akan menampilkan  di sebelah ID atau alias grup bicara yang dipilih.

- 5 Tekan  atau  ke Edit Afiliasi. Tekan  untuk memilih.

- 6 Lakukan salah satu langkah berikut:
 - Tekan  atau  ke Aktif. Tekan  untuk memilih.
 - Tekan  atau  ke Nonaktif. Tekan  untuk memilih.Jika Hidup dipilih,  akan muncul di sebelah ID atau alias grup bicara.

Jika afiliasi berhasil, layar menampilkan  di sebelah ID atau alias grup bicara yang dipilih.

Jika afiliasi gagal,  tetap berada di sebelah ID atau alias grup bicara.







PEMBERITAHUAN:

Radio menampilkan Daftar Penuh saat Anda memilih maksimal tujuh grup bicara untuk afiliasi di daftar pemindaian. Untuk memilih grup bicara afiliasi baru, hapus grup bicara afiliasi yang ada untuk memungkinkan penambahan baru. Lihat [Menghapus Afiliasi Grup Bicara di halaman 109](#) untuk informasi selengkapnya.





Menghapus Afiliasi Grup Bicara



Saat daftar afiliasi penuh dan Anda ingin memilih grup bicara afiliasi baru, hapus grup bicara afiliasi yang ada untuk memungkinkan penambahan baru. Ikuti prosedur untuk menghapus afiliasi grup bicara.





- 1 Tekan  untuk mengakses menu.

- 2 Tekan  atau  ke Pindai. Tekan  untuk memilih.

- 3 Tekan  atau  ke Lihat/Edit Daftar. Tekan  untuk memilih.

- 4 Tekan  atau  ke ID atau alias grup bicara yang diinginkan. Tekan  untuk memilih. Status afiliasi ditampilkan di Daftar Tampilkan/Edit. Layar akan menampilkan  di sebelah ID atau alias grup bicara yang dipilih.

- 5 Tekan  atau  ke Edit Afiliasi. Tekan  untuk memilih.

- 6 Tekan  atau  ke Nonaktif. Tekan  untuk memilih. Jika Mati dipilih,  tidak ditampilkan di samping ID atau alias grup bicara.

Talkback

Fitur Talkback memungkinkan Anda merespons transmisi saat sedang memindai.

Jika radio Anda memindai panggilan dari daftar pindai grup yang dapat dipilih, dan jika tombol **PTT** ditekan selama panggilan terpindai, pengoperasian radio tergantung pada apakah Talkback diaktifkan atau dinonaktifkan selama pemrograman radio. Tanyakan kepada penyalur atau administrator sistem Anda untuk informasi lebih lanjut.

Talkback Nonaktif

Radio keluar dari panggilan terpindai dan mencoba mentransmisikan kontak untuk posisi saluran yang sedang dipilih. Setelah Waktu Hang Panggilan pada kontak yang sedang dipilih berakhir, radio kembali ke saluran awal dan memulai Pencatat Waktu Hang Pemindaian. Radio kembali ke pemindaian grup setelah Pencatat Waktu Hang Pemindaian berakhir.

Talkback Aktif

Jika tombol **PTT** ditekan selama Waktu Hang Grup panggilan terpindai, radio akan mencoba melakukan transmisi grup terpindai.



PEMBERITAHUAN:

Jika memindai panggilan untuk grup yang tidak diberi posisi saluran dalam zona yang sedang dipilih dan panggilan berakhir, beralihlah ke zona yang sesuai lalu pilih posisi saluran grup untuk menjawab grup tersebut.

Bluetooth

Fitur ini memungkinkan Anda untuk menggunakan radio dengan perangkat (aksesori) Bluetooth melalui sambungan Bluetooth. Radio mendukung perangkat Bluetooth dari Motorola Solutions dan COTS (Commercially available Off-The-Shelf).

Bluetooth beroperasi dalam jarak pandang sejauh 10 m (32 kaki). Ini adalah jalur tanpa hambatan antara radio Anda dan perangkat berkemampuan Bluetooth. Untuk keandalan tingkat tinggi, Motorola Solutions menyarankan untuk tidak memisahkan radio dan aksesori.

Di area batas penerimaan, kualitas suara dan nada mulai terdengar "samar" atau "terputus-putus". Untuk mengatasi masalah ini, dekatkan posisi radio dan perangkat berkemampuan Bluetooth (dalam jarak 10 m yang telah ditetapkan) untuk menghasilkan kembali penerimaan audio yang jernih. Fungsi Bluetooth pada radio mempunyai daya maksimum 2,5 mW (4 dBm) dengan jangkauan 10 m.

Radio dapat mendukung hingga tiga sambungan Bluetooth secara bersamaan dengan perangkat Bluetooth dari jenis yang berbeda. Misalnya, headset, pemindai, dan PTT-Only Device (POD). Beberapa sambungan dengan jenis perangkat berkemampuan Bluetooth dari tipe yang sama tidak didukung.

Lihat panduan pengguna untuk perangkat berkemampuan Bluetooth Anda untuk informasi selengkapnya tentang kapabilitas penuh dari perangkat berkemampuan Bluetooth Anda.



PEMBERITAHUAN:





Jika dinonaktifkan melalui CPS, semua fitur terkait Bluetooth akan dinonaktifkan dan database perangkat Bluetooth dihapus.









Mengaktifkan dan Menonaktifkan Bluetooth

Ikuti prosedur untuk mengaktifkan dan menonaktifkan Bluetooth.

- 1 Tekan  untuk mengakses menu.
-

- 2 Tekan  atau  ke Bluetooth. Tekan  untuk memilih.
-



- 3 Tekan  atau  ke Status Saya. Tekan  untuk memilih.
Layar akan menampilkan Aktif dan Nonaktif. Status saat ini ditunjukkan oleh .
-



- 4 Lakukan salah satu langkah berikut:
 - Tekan  atau  ke Aktif. Tekan  untuk memilih. Layar menampilkan  di sebelah Aktif.
 - Tekan  atau  ke Nonaktif. Tekan  untuk memilih. Layar menampilkan  di sebelah Nonaktif.
-



Menghubungkan ke Perangkat Bluetooth





Ikuti prosedur untuk menghubungkan dengan perangkat Bluetooth.

Hidupkan perangkat berkemampuan Bluetooth dan alihkan ke mode pasangan.

- 1 Tekan  atau  untuk mengakses menu.

- 2 Tekan  atau  ke Bluetooth. Tekan  untuk memilih.

- 3 Tekan  atau  ke Perangkat. Tekan  untuk memilih.

- 4 Lakukan salah satu langkah berikut:
 - Tekan  atau  ke perangkat yang diinginkan. Tekan  untuk memilih.
 - Tekan  atau  ke Cari Perangkat untuk mencari perangkat yang tersedia. Tekan

 atau  ke perangkat yang diinginkan.

Tekan  untuk memilih.

- 5 Tekan  atau  ke Hubungkan. Tekan  untuk memilih.

Perangkat berkemampuan Bluetooth mungkin memerlukan langkah-langkah tambahan untuk menyelesaikan pemasangan. Baca panduan pengguna tentang perangkat berkemampuan Bluetooth.

Layar menampilkan Menyambung ke <Perangkat>.

Tunggu respons.

Jika berhasil:

- Nada indikator positif akan berbunyi.
- Layar menampilkan <Perangkat> Terhubung dan ikon **Bluetooth Terhubung**.
- Layar menampilkan  di sebelah perangkat yang terhubung.

Jika tidak berhasil:

- Nada indikator negatif akan berbunyi.

- Layar menampilkan **Gagal Menghubungkan**.









PEMBERITAHUAN:

Jika memerlukan kode PIN, lihat [Mengakses Radio Menggunakan Kata Sandi di halaman 191](#).

Menghubungkan ke Perangkat Bluetooth dalam Mode Dapat Ditemukan

Ikuti prosedur untuk menyambung ke perangkat Bluetooth dalam mode dapat ditemukan.

Hidupkan perangkat berkemampuan Bluetooth dan alihkan ke mode pasang.

- 1 Tekan  untuk mengakses menu.
- 2 Tekan  atau  ke Bluetooth. Tekan  untuk memilih.
- 3 Tekan  atau  ke Temukan Saya. Tekan  untuk memilih. Sekarang radio dapat ditemukan oleh perangkat lain yang berkemampuan

Bluetooth selama durasi yang diprogram. Ini disebut Mode Dapat Ditemukan.

Tunggu respons.

Jika berhasil:

- Nada indikator positif akan berbunyi.
- Layar menampilkan <Perangkat> Terhubung dan ikon **Bluetooth Terhubung**.
- Layar menampilkan  di sebelah perangkat yang terhubung.

Jika tidak berhasil:

- Nada indikator negatif akan berbunyi.
- Layar menampilkan **Gagal Menghubungkan**.

Memutuskan Sambungan dari Perangkat Bluetooth

Ikuti prosedur untuk memutus koneksi dengan perangkat Bluetooth.

- 1 Tekan  untuk mengakses menu.

2 Tekan  atau  ke Bluetooth. Tekan  untuk memilih.

3 Tekan  atau  ke Perangkat. Tekan  untuk memilih.

4 Tekan  atau  ke perangkat yang diinginkan. Tekan  untuk memilih.

5 Tekan  atau  ke Putuskan Sambungan. Tekan  untuk memilih.

Layar menampilkan Memutuskan dari <Perangkat>.



PEMBERITAHUAN:

Perangkat berkemampuan Bluetooth Anda mungkin memerlukan langkah tambahan untuk memutuskan sambungan. Baca panduan pengguna masing-masing untuk perangkat berkemampuan Bluetooth.

Tunggu respons.

- Nada akan berbunyi.
- Layar menampilkan <Perangkat> Terputus dan ikon **Bluetooth Terhubung** hilang.
- Ikon  hilang dari sebelah perangkat yang terhubung.

Mengalihkan Rute Audio antara Speaker Radio Internal dan Perangkat Bluetooth

Ikuti prosedur untuk mengalihkan rute audio antara speaker internal radio dan perangkat Bluetooth eksternal.

Tekan tombol terprogram **Sakelar Audio Bluetooth**.



Layar menampilkan salah satu hasil berikut ini:



- Nada akan berbunyi. Layar menampilkan Rutekan Audio ke Radio.
- Nada akan berbunyi. Layar menampilkan Rutekan Audio ke Bluetooth.



Melihat Detail Perangkat



Ikuti prosedur untuk melihat detail perangkat di radio.

- 1 Tekan  untuk mengakses menu.

- 2 Tekan  atau  ke Bluetooth. Tekan  untuk memilih.

- 3 Tekan  atau  ke Perangkat. Tekan  untuk memilih.



- 4 Tekan  atau  ke perangkat yang diinginkan. Tekan  untuk memilih.



- 5 Tekan  atau  ke Lihat Detail. Tekan  untuk memilih.



Menghapus Nama Perangkat



Anda dapat menghapus perangkat yang diputus sambungannya dari daftar perangkat berkemampuan Bluetooth.

- 1 Tekan  untuk mengakses menu.

- 2 Tekan  atau  ke Bluetooth. Tekan  untuk memilih.

- 3 Tekan  atau  ke Perangkat. Tekan  untuk memilih.

- 4 Tekan  atau  ke perangkat yang diinginkan. Tekan  untuk memilih.

- 5 Tekan  atau  ke Hapus. Tekan  untuk memilih. Layar menampilkan Perangkat Dihapus.



Penguatan Mikrofon Bluetooth

Dengan fitur ini, pengguna dapat mengontrol nilai penguatan mikrofon pada perangkat berkemampuan Bluetooth yang terhubung.

- 1 Tekan  untuk mengakses menu.

2 Tekan  atau  ke Bluetooth. Tekan  untuk memilih.

3 Tekan  atau  ke Penguatan Mik BT. Tekan  untuk memilih.

4 Tekan  atau  ke jenis Penguatan Mik BT dan nilai saat ini. Tekan  untuk memilih. Anda dapat mengedit nilai di sini.

5 Tekan  atau  untuk menambah atau mengurangi nilai. Tekan  untuk memilih.

Lokasi Dalam Ruangan









PEMBERITAHUAN:

Fitur Lokasi Dalam Ruangan hanya berlaku untuk model dengan perangkat lunak dan perangkat keras terbaru. Tanyakan kepada penyalur atau administrator sistem Anda untuk informasi lebih lanjut.

Lokasi Dalam Ruangan digunakan untuk terus melacak lokasi pengguna radio. Apabila Lokasi Dalam Ruangan diaktifkan, radio berada dalam mode dapat ditemukan terbatas. Suar terdedikasi digunakan untuk menemukan lokasi radio dan menentukan posisinya.

Mengaktifkan atau Menonaktifkan Lokasi Dalam Ruangan

Anda dapat mengaktifkan atau menonaktifkan Lokasi Dalam Ruangan dengan melakukan satu tindakan berikut ini.

- Akses fitur ini melalui menu.
 - a. Tekan  untuk mengakses menu.
 - b. Tekan  atau  ke Bluetooth dan tekan  untuk memilih.
 - c. Tekan  atau  ke Lokasi Dalam Ruangan dan tekan  untuk memilih.

- d. Tekan  untuk mengaktifkan Lokasi Dalam Ruang.

Layar menampilkan Lokasi Dalam Ruang Aktif. Anda mendengarkan nada indikator positif.

Salah satu skenario berikut ini akan terjadi.

- Jika berhasil, ikon Lokasi Dalam Ruang Tersedia akan muncul di tampilan layar Awal.
- Jika tidak berhasil, layar menampilkan Pengaktifan Gagal. Anda mendengarkan nada indikator negatif.

- e. Tekan  untuk menonaktifkan Lokasi Dalam Ruang.

Layar menampilkan Lokasi Dalam Ruang Nonaktif. Anda mendengarkan nada indikator positif.

Salah satu skenario berikut ini akan terjadi.

- Jika berhasil, ikon Lokasi Dalam Ruang Tersedia akan hilang dari tampilan layar Awal.

- Jika tidak berhasil, layar menampilkan Penonaktifan Gagal. Anda mendengarkan nada indikator negatif.

- Akses fitur ini menggunakan tombol terprogram.

- a. Tekan lama tombol **Lokasi Dalam Ruang** terprogram untuk mengaktifkan Lokasi Dalam Ruang.

Layar menampilkan Lokasi Dalam Ruang Aktif. Anda mendengarkan nada indikator positif.

Salah satu skenario berikut ini akan terjadi.

- Jika berhasil, ikon Lokasi Dalam Ruang Tersedia akan muncul di tampilan layar Awal.
- Jika tidak berhasil, layar menampilkan Pengaktifan Gagal. Jika tidak berhasil, Anda akan mendengar nada indikator negatif.

- b. Tekan tombol **Lokasi Dalam Ruang** terprogram untuk menonaktifkan Lokasi Dalam Ruang.

Layar menampilkan Lokasi Dalam Ruang Nonaktif. Anda mendengarkan nada indikator positif.



Salah satu skenario berikut ini akan terjadi.



- Jika berhasil, ikon Lokasi Dalam Ruangan Tersedia akan hilang dari tampilan layar Awal.
- Jika tidak berhasil, layar menampilkan Penonaktifan Gagal. Jika tidak berhasil, Anda akan mendengar nada indikator negatif.

Mengakses Informasi Suar Lokasi Dalam Ruangan

Ikuti prosedur untuk mengakses informasi suar Lokasi Dalam Ruangan.

- 1 Tekan  untuk mengakses menu.

- 2 Tekan  atau  ke Bluetooth dan tekan  untuk memilih.

- 3 Tekan  atau  ke Lokasi Dalam Ruangan dan tekan  untuk memilih.

- 4 Tekan  atau  ke Suar dan tekan  untuk memilih.

Layar menampilkan informasi suar.

Kontrol Multisite

Fitur ini berlaku bila saluran radio saat ini dikonfigurasi ke sistem Kapasitas Maks.

Memulai Pencarian Site Manual

Ikuti prosedur untuk memulai pencarian site manual saat kekuatan sinyal yang diterima lemah untuk mencoba menemukan site dengan sinyal yang lebih baik.

Jika radio menemukan site baru:

- Nada indikator positif akan berbunyi.

Jika radio gagal menemukan site baru:

- Nada indikator negatif akan berbunyi.

Kunci Site Aktif/Nonaktif

Ketika diaktifkan, radio akan mencari site saat ini saja.
Ketika dinonaktifkan, radio akan mencari site lain di samping site saat ini.

Tekan tombol **Kunci Site**.

Jika fungsi **Kunci Site** diaktifkan:

- Anda mendengar nada indikator positif, yang menunjukkan radio telah dikunci ke site saat ini.
- Layar akan menampilkan Site Terkunci.

Jika fungsi **Kunci Site** dinonaktifkan:

- Anda mendengar nada indikator negatif, menandakan bahwa radio tidak terkunci.
- Layar akan menampilkan Site Tidak Terkunci.



Mengakses Daftar Site Tetangga

Fitur ini memungkinkan pengguna memeriksa daftar site yang bersebelahan pada site asal saat ini. Ikuti prosedur untuk mengakses Daftar Site Tetangga:

1 Tekan  untuk mengakses menu.

2 Tekan  atau  ke Utilitas. Tekan  untuk memilih.

3 Tekan  atau  ke Info Radio. Tekan  untuk memilih.

4 Tekan  atau  ke Site Tetangga. Tekan  untuk memilih.

Pengingat Saluran Rumah

Fitur ini akan mengingatkan ketika radio tidak diatur ke saluran rumah selama jangka waktu tertentu.

Jika fitur ini diaktifkan saat radio tidak diatur ke saluran rumah selama jangka waktu tertentu, hal berikut ini terjadi secara berkala:

- Nada Pengingat Saluran Rumah dan suara pengumuman berbunyi.
- Baris pertama layar menampilkan Non.

- Baris kedua menampilkan Saluran Rumah.

Mematikan Suara Pengingat Saluran Rumah

Ketika Pengingat Saluran Rumah berbunyi, Anda dapat mematikan suaranya.

Tekan tombol **Senyapkan Pengingat Saluran Rumah** yang dapat diprogram.

Baris pertama layar menampilkan HCR dan baris kedua menampilkan Disenyapkan.

Mengatur Saluran Rumah Baru

Jika Pengingat Saluran Rumah terjadi, Anda dapat menetapkan saluran rumah baru.



- 1 Lakukan salah satu langkah berikut:
 - Tekan tombol yang dapat diprogram **Atur Ulang Saluran Rumah** untuk mengatur saluran saat ini sebagai Saluran Rumah yang baru. Lompati langkah-langkah berikut ini.





Baris pertama layar menampilkan alias saluran dan baris kedua menampilkan Saluran Rumah Baru.

- Tekan  untuk mengakses menu.

2 Tekan  atau  ke Utilitas. Tekan  untuk memilih.

3 Tekan  atau  ke Pengaturan Radio. Tekan  untuk memilih.

4 Tekan  atau  ke Saluran Rumah. Tekan  untuk memilih.

5 Tekan  atau  ke alias saluran rumah baru yang diinginkan. Tekan  untuk memilih. Layar menampilkan  di sebelah alias saluran rumah yang dipilih.

Monitor Jauh

Fitur ini digunakan untuk mengaktifkan mikrofon radio target dengan alias atau ID subscriber. Anda dapat menggunakan fitur ini untuk memantau dari jauh aktivitas yang dapat didengar di sekitar radio target.

Radio Anda dan radio target harus diprogram agar Anda bisa menggunakan fitur ini.

Jika aktif, lampu LED berwarna hijau pada radio target akan berkedip satu kali. Fitur ini secara otomatis berhenti setelah durasi yang telah diprogram atau bila radio target dioperasikan oleh pengguna.

Menginisiasi Monitor Jauh

Ikuti prosedur untuk mengaktifkan Monitor Jauh di radio Anda.

- 1 Tekan tombol **Monitor Jauh** terprogram.
-

- 2 Tekan  atau  ke alias atau ID yang diinginkan. Tekan  untuk memilih.

Layar menampilkan pemberitahuan mini transisional, yang menunjukkan permintaan sedang diproses. LED hijau akan menyala.

- 3 Tunggu respons.

Jika berhasil:

- Nada indikator positif akan berbunyi.
- Layar menampilkan pemberitahuan mini positif.
- Audio dari radio yang dimonitor mulai memutar durasi terprogram dan layar menampilkan Mon. Jauh. Setelah pencatat waktu berakhir, nada peringatan akan berbunyi dan LED akan mati.



Jika tidak berhasil:



- Nada indikator negatif akan berbunyi.
 - Layar menampilkan pemberitahuan mini negatif.
-



Mengaktifkan Monitor Jauh Menggunakan Daftar Kontak

Ikuti prosedur untuk melakukan Monitor Jauh di radio Anda menggunakan daftar Kontak.

- 1 Tekan  untuk mengakses menu.

- 2 Tekan  atau  ke Kontak. Tekan  untuk memilih.

- 3 Tekan  atau  ke alias atau ID yang diinginkan. Tekan  untuk memilih.

- 4 Tekan  atau  ke Mon. Jauh. Tekan  untuk memilih.
Layar menampilkan pemberitahuan mini transisional, yang menunjukkan permintaan sedang diproses. LED hijau akan menyala.

- 5 Tunggu respons.
Jika berhasil:

- Nada indikator positif akan berbunyi.
- Layar menampilkan pemberitahuan mini positif.
- Audio dari radio yang dimonitor mulai memutar durasi terprogram dan layar menampilkan Mon. Monitor (Monitor Jauh). Setelah pencatat waktu berakhir, nada peringatan akan berbunyi dan LED akan mati.



Jika tidak berhasil:

- Nada indikator negatif akan berbunyi.
- Layar menampilkan pemberitahuan mini negatif.

Mengaktifkan Monitor Jauh Menggunakan Panggilan Manual

Ikuti prosedur untuk melakukan Monitor Jauh di radio Anda menggunakan panggilan manual.

- 1 Tekan  untuk mengakses menu.

- 2 Tekan  atau  ke Kontak. Tekan  untuk memilih.

3 Tekan  atau  ke Panggilan Manual.

Tekan  untuk memilih.

4 Tekan  atau  ke Nomor Radio. Tekan

 untuk memilih.

5 Lakukan salah satu langkah berikut:

- Masukkan alias atau ID subscriber, lalu tekan

 untuk melanjutkan.

- Edit ID yang dipanggil sebelumnya, lalu tekan

 untuk melanjutkan.

6 Tekan  atau  ke Mon. Jauh. Tekan  untuk memilih.

Layar menampilkan pemberitahuan mini transisional, yang menunjukkan permintaan sedang diproses. LED hijau akan menyala.

7 Tunggu respons.

Jika berhasil:

- Nada indikator positif akan berbunyi.
- Layar menampilkan pemberitahuan mini positif.
- Audio dari radio yang dimonitor mulai memutar durasi terprogram dan layar menampilkan Mon. Monitor. Setelah pencatat waktu berakhir, nada peringatan akan berbunyi dan LED akan mati.

Jika tidak berhasil:

- Nada indikator negatif akan berbunyi.
 - Layar menampilkan pemberitahuan mini negatif.
-

Pengaturan Kontak

Kontak mempunyai kemampuan seperti buku telepon di radio Anda. Setiap entri berhubungan dengan suatu alias atau ID yang Anda gunakan untuk memulai panggilan. Entri diurutkan berdasar abjad.

Bergantung konteksnya, tiap entri terkait dengan jenis panggilan yang berbeda: Panggilan Grup, Panggilan Pribadi, Panggilan Siaran, Semua Panggilan Site, Semua Panggilan Multisite, Panggilan PC, atau Panggilan Dispatch.

Panggilan PC dan Panggilan Dispatch terkait dengan data. Ini hanya tersedia dengan aplikasi. Untuk detail selengkapnya, lihat dokumentasi aplikasi data.

Selain itu, melalui menu Kontak, Anda dapat menetapkan tiap entri ke satu atau beberapa tombol angka yang dapat diprogram pada mikrofon keypad. Jika ada entri yang ditentukan ke tombol angka, radio dapat melakukan sambungan cepat pada entri itu.



PEMBERITAHUAN:

Tanda centang akan ditampilkan di depan setiap tombol angka yang ditetapkan ke entri tertentu. Jika tanda centang muncul di depan **Kosong**, berarti Anda belum menetapkan tombol angka ke entri apa pun.

Masing-masing entri dalam Kontak menampilkan informasi berikut ini:

- Jenis Panggilan
- Alias Panggilan
- ID Panggilan





PEMBERITAHUAN:



Jika fitur Privasi telah diaktifkan di suatu saluran, Anda bisa melakukan Panggilan Grup dengan privasi aktif, Panggilan Pribadi, Semua Panggilan, dan Panggilan Telepon di saluran itu. Hanya radio target dengan Kunci Privasi yang sama, atau Nilai Kunci dan ID Kunci yang sama dengan radio Anda yang bisa mendekripsi transmisi tersebut.



Mengalokasikan Entri ke Tombol Angka yang Dapat Diprogram

Ikuti prosedur untuk mengalokasikan entri ke tombol angka yang dapat diprogram pada radio Anda.



- 1 Tekan  untuk mengakses menu.



- 2 Tekan  atau  ke **Kontak**. Tekan  untuk memilih.

- 3 Tekan  atau  ke alias atau ID yang diinginkan. Tekan  untuk memilih.

4 Tekan  atau  ke Tombol Program. Tekan  untuk memilih.

5 Lakukan salah satu langkah berikut:

- Jika tombol angka yang diinginkan belum dialokasikan untuk sebuah entri, tekan  atau  ke tombol angka yang diinginkan. Tekan  untuk memilih.
- Jika tombol angka yang diinginkan sudah dialokasikan untuk sebuah entri, layar menampilkan Tombol Sudah Dialokasikan dan baris teks pertama menampilkan Timpa?. Lakukan salah satu langkah berikut:

Tekan  atau  ke Ya. Tekan  untuk memilih.

Radio membunyikan nada indikator positif dan layar menampilkan Kontak Disimpan serta pemberitahuan mini positif.

Tekan  atau  ke Tidak untuk kembali ke langkah sebelumnya.

Setiap entri dapat dikaitkan ke berbagai tombol angka. Anda melihat ✓ sebelum tiap tombol angka yang dialokasikan pada entri. Jika ✓ terdapat sebelum Kosong, maka tombol angka tidak ditetapkan.

Jika sebuah tombol angka dialokasikan untuk sebuah entri dalam mode tertentu, fitur ini tidak didukung apabila Anda menekan lama tombol angka dalam mode yang lain.

Layar kembali ke menu sebelumnya secara otomatis.

Menghapus Kaitan Antara Entri dan Tombol Angka yang Dapat Diprogram



Ikuti prosedur untuk menghapus kaitan antara entri dan tombol angka yang dapat diprogram pada radio Anda.

1 Lakukan salah satu langkah berikut:

- Tekan lama tombol angka terprogram ke alias atau ID yang diinginkan. Lanjutkan ke [langkah 4](#).
 - Tekan  untuk mengakses menu.
-

2 Tekan  atau  ke Kontak. Tekan  untuk memilih.

3 Tekan  atau  ke alias atau ID yang diinginkan. Tekan  untuk memilih.

4 Tekan  atau  ke Tombol Program. Tekan  untuk memilih.

5 Tekan  atau  ke Kosongkan. Tekan  untuk memilih.

Baris teks pertama menampilkan Hapus dari semua tombol.

6 Tekan  atau  ke Ya. Tekan  untuk memilih.



PEMBERITAHUAN:

Bila salah satu entri dihapus, kaitan antara entri tersebut dan tombol angka terprogram juga akan dihapus.



Nada indikator positif akan berbunyi. Layar akan menampilkan Kontak Disimpan. Layar kembali ke menu sebelumnya secara otomatis.

Menambahkan Kontak Baru

Ikuti prosedur untuk menambahkan kontak baru di radio Anda.

1 Tekan  untuk mengakses menu.



2 Tekan  atau  ke Kontak. Tekan  untuk memilih.

3 Tekan  atau  ke Kontak Baru. Tekan  untuk memilih.

4 Tekan  atau  untuk memilih jenis kontak Kontak Radio atau Kontak Telepon. Tekan  untuk memilih.

5 Masukkan nomor kontak dengan keypad, lalu tekan  untuk melanjutkan.

6 Masukkan nama kontak dengan keypad, lalu tekan  untuk melanjutkan.

7 Tekan  atau  ke jenis dering yang diinginkan. Tekan  untuk memilih.
Nada indikator positif akan berbunyi. Layar menampilkan pemberitahuan mini positif.

Pengaturan Indikator Panggilan

Fitur ini memungkinkan pengguna radio mengonfigurasi panggilan atau pesan teks yang menderingkan nada.

Mengaktifkan atau Menonaktifkan Dering Panggilan untuk Panggilan Pribadi

Ikuti prosedur untuk mengaktifkan atau menonaktifkan dering panggilan untuk Panggilan Pribadi di radio Anda.

1 Tekan  untuk mengakses menu.

2 Tekan  atau  ke Utilitas. Tekan  untuk memilih.

3 Tekan  atau  ke Pengaturan Radio. Tekan  untuk memilih.

4 Tekan  atau  ke Nada/Peringatan. Tekan  untuk memilih.

5 Tekan  atau  ke Dering Panggilan.



Tekan  untuk memilih.

6 Tekan  atau  ke Panggilan Pribadi.

Tekan  untuk memilih.

7 Tekan  atau  ke nada yang diinginkan.

Tekan  untuk memilih.

Jika diaktifkan,  muncul di sebelah Diaktifkan.
Jika dinonaktifkan,  hilang dari sebelah Diaktifkan.

Mengaktifkan atau Menonaktifkan Dering Panggilan untuk Pesan Teks

Ikuti prosedur untuk mengaktifkan atau menonaktifkan dering panggilan pesan teks di radio Anda.

1 Tekan  untuk mengakses menu.

2 Tekan  atau  ke Utilitas. Tekan  untuk memilih.

3 Tekan  atau  ke Pengaturan Radio.

Tekan  untuk memilih.

4 Tekan  atau  ke Nada/Peringatan.

Tekan  untuk memilih.



5 Tekan  atau  ke Dering Panggilan.

Tekan  untuk memilih.

6 Tekan  atau  ke Pesan Teks. Tekan  untuk memilih.

Layar menampilkan  dan nada saat ini.



7 Tekan  atau  ke nada yang diinginkan.



Tekan  untuk memilih. Layar menampilkan  di sebelah nada yang dipilih.



Mengaktifkan atau Menonaktifkan Dering Panggilan untuk Peringatan Panggilan



Ikuti prosedur untuk mengaktifkan atau menonaktifkan dering panggilan untuk Peringatan Panggilan di radio Anda.



- 1 Tekan  untuk mengakses menu.





- 2 Tekan  atau  ke Utilitas. Tekan  untuk memilih.

- 3 Tekan  atau  ke Pengaturan Radio. Tekan  untuk memilih.

- 4 Tekan  atau  ke Nada/Peringatan. Tekan  untuk memilih.

- 5 Tekan  atau  ke Dering Panggilan. Tekan  untuk memilih.



- 6 Tekan  atau  ke Peringatan Panggilan. Tekan  untuk memilih.

- 7 Tekan  atau  ke nada yang diinginkan. Tekan  untuk memilih. Layar menampilkan  di sebelah nada yang dipilih.

Mengaktifkan atau Menonaktifkan Dering Panggilan untuk Panggilan Selektif

Ikuti prosedur untuk mengaktifkan atau menonaktifkan dering panggilan untuk Panggilan Selektif di radio Anda.

- 1 Tekan  untuk mengakses menu.

- 2 Tekan  atau  ke Utilitas. Tekan  untuk memilih.

3 Tekan  atau  ke Pengaturan Radio.

Tekan  untuk memilih.

4 Tekan  atau  ke Nada/Peringatan.

Tekan  untuk memilih.

5 Tekan  atau  ke Dering Panggilan.



Tekan  untuk memilih.

6 Tekan  atau  ke Panggilan Selektif.

Tekan  untuk memilih.

Layar menampilkan  dan nada saat ini.

7 Tekan  atau  ke nada yang diinginkan.

Tekan  untuk memilih. Layar menampilkan  di sebelah nada yang dipilih.

Mengaktifkan atau Menonaktifkan Dering Panggilan untuk Status Telemetri dengan Teks

Ikuti prosedur untuk mengaktifkan atau menonaktifkan dering panggilan untuk status telemetri dengan teks di radio Anda.

1 Tekan  untuk mengakses menu.

2 Tekan  atau  ke Utilitas. Tekan  untuk memilih.

3 Tekan  atau  ke Pengaturan Radio.

Tekan  untuk memilih.

4 Tekan  atau  ke Nada/Peringatan.

Tekan  untuk memilih.

5 Tekan  atau  ke Dering Panggilan.







Tekan  untuk memilih.

- 6 Tekan  atau  ke Telemetri. Tekan  untuk memilih.



Zona saat ini akan ditandai dengan .





Menetapkan Gaya Dering

Radio bisa diprogram agar membunyikan salah satu dari sebelas nada dering ketika menerima Panggilan Pribadi, Peringatan Panggilan, atau Pesan Teks dari kontak tertentu. Radio membunyikan setiap gaya dering ketika Anda menelusuri daftar ini. Ikuti prosedur untuk mengalokasikan gaya dering di radio Anda.

- 1 Tekan  untuk mengakses menu.
- 2 Tekan  atau  ke Kontak. Tekan  untuk memilih.
Entri diurutkan berdasar abjad.
- 3 Tekan  atau  ke alias atau ID yang diinginkan. Tekan  untuk memilih.

- 4 Tekan  atau  ke Lihat/Edit. Tekan  untuk memilih.

- 5 Tekan  hingga layar menampilkan menu Dering.
Tanda  menunjukkan nada yang dipilih saat ini.

- 6 Tekan  atau  ke nada yang diinginkan.
Tekan  untuk memilih.
 muncul di samping nada yang dipilih.

Volume Nada Alarm yang Semakin Tinggi

Radio dapat diprogram untuk terus memberitahukan bila terdapat panggilan radio yang tidak terjawab. Hal ini dilakukan dengan otomatis meningkatkan volume nada alarm secara berkala. Fitur ini disebut Escalart.

Fitur Log Panggilan

Radio Anda terus mencatat semua Panggilan Pribadi keluar, yang dijawab, dan yang tidak terjawab. Fitur log panggilan digunakan untuk melihat dan mengelola panggilan terbaru.



Peringatan Panggilan Tak Terjawab dapat disertakan dapat log panggilan, tergantung konfigurasi sistem di radio Anda. Anda dapat melakukan tugas berikut ini di masing-masing daftar panggilan Anda:



- Menyimpan Alias atau ID ke Kontak
- Hapus Panggilan
- Menghapus Semua Panggilan
- Lihat Detail

Melihat Panggilan Terbaru

Ikuti prosedur untuk melihat panggilan terbaru di radio Anda.

- 1 Tekan  untuk mengakses menu.
-

- 2 Tekan  atau  ke Log Panggilan. Tekan  untuk memilih.
-

- 3 Tekan  atau  ke daftar yang diinginkan. Opsi yang tersedia adalah daftar Tak Terjawab, Terjawab, dan Keluar.

Tekan  untuk memilih.

Layar akan menampilkan entri paling kini.



- 4 Tekan  atau  untuk melihat daftar.



Anda dapat memulai panggilan dengan alias atau ID yang sedang ditampilkan layar dengan menekan tombol **PTT** .



Menyimpan Alias atau ID dari Daftar Panggilan



Ikuti prosedur untuk menyimpan alias atau ID di radio Anda dari Daftar Panggilan.

- 1 Tekan  untuk mengakses menu.

- 2 Tekan  atau  ke Log Panggilan. Tekan  untuk memilih.

- 3 Tekan  atau  ke daftar yang diinginkan. Tekan  untuk memilih.

- 4 Tekan  atau  ke alias atau ID yang diinginkan. Tekan  untuk memilih.

- 5 Tekan  atau  ke Simpan. Tekan  untuk memilih.
Layar menampilkan kursor berkedip.

- 6 Masukkan sisa karakter dari alias yang diperlukan.
Tekan  untuk memilih.



Anda dapat menyimpan ID tanpa alias.



Layar menampilkan pemberitahuan mini positif.



Menghapus Panggilan dari Daftar Panggilan



Ikuti prosedur untuk menghapus panggilan dari daftar Panggilan di radio Anda.

- 1 Tekan  untuk mengakses menu.





- 2 Tekan  atau  ke Log Panggilan. Tekan  untuk memilih.

- 3 Tekan  atau  ke daftar yang diinginkan. Tekan  untuk memilih.
Jika daftar kosong:
 - Nada akan berbunyi.
 - Layar menampilkan Daftar Kosong.

4 Tekan  atau  ke alias atau ID yang diinginkan. Tekan  untuk memilih.

5 Tekan  atau  ke Hapus Entri?. Tekan  untuk memilih.

6 Lakukan salah satu langkah berikut:



- Tekan  untuk memilih Ya untuk menghapus entri. Layar menampilkan Entri Dihapus.
 - Tekan  atau  ke Tidak. Tekan  untuk memilih. Radio kembali ke layar sebelumnya.
-



Menghapus Semua Panggilan dari Daftar Panggilan

Ikuti prosedur untuk menghapus semua panggilan dari daftar Panggilan di radio Anda.

1 Tekan  untuk mengakses menu.

2 Tekan  atau  ke Log Panggilan. Tekan  untuk memilih.

3 Tekan  atau  ke daftar yang diinginkan. Tekan  untuk memilih.

4 Tekan  atau  ke alias atau ID yang diinginkan. Tekan  untuk memilih.

5 Tekan  atau  ke Hapus Semua. Tekan  untuk memilih.

6 Lakukan salah satu langkah berikut:



- Tekan  untuk memilih Ya untuk menghapus semua entri. Layar menampilkan pemberitahuan mini positif.



- Tekan  atau  ke Tidak. Tekan  untuk memilih.
Radio kembali ke layar sebelumnya.
-



Melihat Detail dari Daftar Panggilan



Ikuti prosedur untuk melihat detail di radio Anda dari daftar Panggil.

- 1 Tekan  untuk mengakses menu.

- 2 Tekan  atau  ke Log Panggilan. Tekan  untuk memilih.

- 3 Tekan  atau  ke daftar yang diinginkan. Tekan  untuk memilih.

- 4 Tekan  atau  ke alias atau ID yang diinginkan. Tekan  untuk memilih.

- 5 Tekan  atau  ke Lihat Detail. Tekan  untuk memilih.
Layar menampilkan detail.
-

Operasi Peringatan Panggilan

Penyerantaan Peringatan Panggilan memungkinkan Anda mengingatkan pengguna radio tertentu untuk memanggil Anda kembali ketika dia bisa melakukannya.

Fitur ini hanya tersedia untuk alias atau ID subscriber dan dapat diakses melalui menu menggunakan Kontak, panggilan manual, atau tombol terprogram **Akses Satu Sentuhan**.

Di Capacity Max, fitur Peringatan Panggilan memungkinkan pengguna radio atau dispatcher mengirim peringatan ke pengguna radio lain dengan meminta pengguna radio tersebut memanggil balik pengguna radio yang memulai panggilan jika tersedia. Komunikasi suara tidak ada dalam fitur ini.

Operasi Peringatan Panggilan dapat dikonfigurasi oleh penyalur atau administrator sistem dalam dua cara:

- Radio dikonfigurasi untuk mengizinkan pengguna menekan tombol **PTT** untuk merespons langsung ke inisiator panggilan dengan melakukan Panggilan Pribadi.
- Radio dikonfigurasi untuk mengizinkan pengguna menekan tombol **PTT** dan melanjutkan komunikasi Grup Bicara lain. Menekan tombol **PTT** pada entri peringatan panggilan tidak akan mengizinkan pengguna merespons inisiator panggilan. Pengguna harus menavigasi ke opsi Log Panggilan Tak Terjawab di menu Log Panggilan dan merespons Peringatan Panggilan dari situ.

Panggilan pribadi Penyiapan Panggilan Off Air (OACSU) memungkinkan pengguna merespons langsung, sedangkan panggilan pribadi Penyiapan Panggilan Off Air Penuh (FOACSU) memerlukan respons pengguna untuk panggilan tersebut. Karenanya, panggilan jenis OACSU direkomendasikan untuk digunakan dengan fitur peringatan panggilan. Lihat [Panggilan Pribadi di halaman 76](#).

Melakukan Peringatan Panggilan

Ikuti prosedur untuk melakukan Peringatan Panggilan di radio Anda.

- 1 Tekan tombol **Akses Satu Sentuhan** terprogram.

Layar menampilkan Peringatan Panggilan dan alias atau ID subscriber. LED hijau akan menyala.

- 2 Tunggu respons.

Jika respons Peringatan Panggilan diterima, layar akan menampilkan pemberitahuan mini positif.



Jika respons Peringatan Panggilan tidak diterima, layar akan menampilkan pemberitahuan mini negatif.



Membuat Peringatan Panggilan Menggunakan Daftar Kontak

Ikuti prosedur untuk melakukan Peringatan Panggilan di radio Anda menggunakan daftar Kontak.

- 1 Tekan  untuk mengakses menu.
-

- 2 Tekan  atau  ke Kontak. Tekan  untuk memilih.
-

3 Tekan  atau  ke alias atau ID yang diinginkan. Tekan  untuk memilih.

4 Tekan  atau  ke Peringatan Panggilan. Tekan  untuk memilih.
Layar menampilkan Peringatan Panggilan dan alias atau ID subscriber. LED hijau akan menyala.

5 Tunggu respons.

- Jika respons Peringatan Panggilan diterima, layar akan menampilkan pemberitahuan mini positif.
- Jika respons Peringatan Panggilan tidak diterima, layar akan menampilkan pemberitahuan mini negatif.

Merrespons Peringatan Panggilan

Ikuti prosedur untuk merespons Alarm Panggilan di radio Anda.

Ketika Anda menerima Peringatan Panggilan:

- Nada berulang akan berbunyi.
- LED kuning akan berkedip.
- Layar menampilkan daftar notifikasi yang berisi Peringatan Panggilan dengan alias atau ID radio pemanggil.

Tergantung konfigurasi oleh dealer atau administrator sistem, Anda dapat merespons Peringatan Panggilan dengan melakukan salah satu hal berikut:

- Tekan tombol **PTT** dan respons dengan Panggilan Pribadi secara langsung ke pemanggil.
 - Tekan tombol **PTT** untuk melanjutkan komunikasi grup bicara normal. Peringatan Panggilan dipindahkan ke opsi Panggilan Tak Terjawab di menu Log. Anda dapat merespons pemanggil dari log Panggilan Tak Terjawab.
-

Lihat [Daftar Notifikasi di halaman 194](#) dan [Fitur Log Panggilan di halaman 132](#) untuk informasi selengkapnya.

Mode Bisu

Mode Bisu memungkinkan pengguna untuk membisukan semua indikator audio di radio.

Setelah Mode Bisu aktif, semua indikator audio dibisukan, kecuali fitur dengan prioritas lebih tinggi misalnya Operasi darurat.

Setelah keluar dari Mode Bisu, radio melanjutkan pemutaran nada dan transmisi audio.



PEMBERITAHUAN:

Fitur ini dapat dibeli. Tanyakan kepada penyalur atau administrator sistem Anda untuk informasi lebih lanjut.

Mengaktifkan Mode Bisu

Ikuti prosedur untuk menonaktifkan Mode Bisu.

Akses fitur ini menggunakan tombol **Mode Bisu** terprogram.

Hal berikut mungkin terjadi saat Mode bisu aktif:





- Nada Indikator Positif Akan Berbunyi.
- Layar menampilkan Mode Bisu Aktif.

- Lampu LED berwarna merah akan terus berkedip hingga Anda keluar dari Mode Bisu.
- Layar menampilkan ikon **Mode Bisu** di layar utama.
- Radio dibisukan.
- Pewaktu Mode Bisu mulai menghitung mundur dengan durasi yang dikonfigurasi.

Menyetel Pewaktu Mode Bisu

Fitur Mode Bisu dapat diaktifkan dalam waktu yang telah dikonfigurasi terlebih dahulu dengan menyetel Pewaktu Mode Bisu. Durasi pewaktu dikonfigurasi di menu radio dengan rentang antara 0,5–6 jam. Anda akan dikeluarkan dari Mode Bisu setelah pewaktu kedaluwarsa.

Jika pewaktu habis pada angka 0, radio tetap berada dalam Mode bisu selama waktu yang tidak ditentukan hingga tombol **Mode Bisu** terprogram ditekan.



- 1 Tekan  untuk mengakses menu.
- 2 Tekan  atau  ke *Utilitas*. Tekan  untuk memilih.

3 Tekan  atau  ke Pengaturan Radio.

Tekan  untuk memilih.

4 Tekan  atau  ke Pewaktu Mode Bisu.

Tekan  untuk memilih.

5 Tekan  atau  untuk mengedit nilai angka setiap digit, lalu tekan .

- Layar menampilkan Mode Bisu Nonaktif.
- Lampu LED berwarna merah mati.
- Ikon **Mode Bisu** hilang dari layar utama.
- Radio menghidupkan suara dan status speaker dipulihkan.
- Jika pewaktu belum kedaluwarsa, Pewaktu mode bisu dihentikan.



PEMBERITAHUAN:

Pengguna juga dikeluarkan dari Mode Bisu jika mengirimkan suara atau beralih ke saluran yang belum terprogram.

Keluar dari Mode Bisu

Fitur ini dapat dikeluarkan secara otomatis setelah Pewaktu Mode Bisu kedaluwarsa.

Lakukan salah satu hal berikut untuk keluar dari Mode bisu secara manual:

- Tekan tombol **Mode Bisu** terprogram.
 - Tekan tombol **PTT** pada entri apa pun.
-

Hal berikut akan terjadi saat Mode bisu nonaktif:

- Nada Indikator Negatif Akan Berbunyi.

Pengoperasian Darurat

Alarm Darurat digunakan untuk menunjukkan situasi genting. Anda dapat menginisiasi keadaan Darurat setiap saat, walaupun terdapat aktivitas pada saluran aktif.

Di Capacity Max, radio penerima hanya dapat mendukung satu Alarm Darurat dalam satu waktu. Jika dimulai, Alarm Darurat kedua akan menimpa alarm pertama.

Ketika radio menerima Alarm Darurat, penerima dapat memilih untuk menghapus alarm dan keluar dari Daftar

Alarm, atau merespons Alarm Darurat dengan menekan tombol **PTT** dan memancarkan suara non-darurat.

Dealer atau administrator sistem Anda bisa mengatur durasi penekanan tombol untuk tombol **Darurat** terprogram, kecuali untuk penekanan lama, yang sama dengan semua tombol lainnya:

Tekan Sebentar

Durasi antara 0,05 hingga 0,75 detik.

Tekan Lama

Durasi antara 1,00 hingga 3,75 detik.

Tombol **Darurat** ditetapkan ke fitur Darurat Aktif/Tidak Aktif. Tanyakan kepada dealer tentang pengoperasian yang ditetapkan dari tombol **Darurat**.



PEMBERITAHUAN:

Jika penekanan singkat dari tombol **Darurat** ditetapkan untuk menghidupkan mode Darurat, penekanan lama tombol **Darurat** ditetapkan untuk keluar dari mode Darurat.

Jika penekanan lama dari tombol **Darurat** ditetapkan untuk menghidupkan mode Darurat, penekanan singkat tombol **Darurat** ditetapkan untuk keluar dari mode Darurat.

Radio Anda mendukung tiga Alarm Darurat:

- Alarm Darurat
- Alarm Darurat dengan Panggilan
- Alarm Darurat dengan Suara untuk Diikuti

Selain itu, tiap alarm mempunyai jenis berikut:

Reguler

Radio mentransmisikan sinyal alarm dan menunjukkan indikator audio dan/atau visual.

Senyap

Radio mentransmisikan sinyal alarm tanpa ada indikator audio atau visual. Radio menerima panggilan tanpa suara apa pun melalui speaker, sampai periode transmisi terprogram *hot mic* berakhir dan/atau Anda menekan tombol **PTT**.

Senyap dengan Suara

Radio mentransmisikan sinyal alarm tanpa indikator audio atau visual apa pun, namun mengizinkan panggilan masuk berbunyi melalui speaker.



PEMBERITAHUAN:

Hanya salah **satu** dari Alarm Darurat di atas dapat ditetapkan untuk tombol **Darurat** yang telah diprogram atau sakelar kaki Darurat.

Mengirim Alarm Darurat

Dengan fitur ini Anda bisa mengirim Alarm Darurat, sinyal non-suara, yang memicu indikasi peringatan pada sebuah grup radio. Ikuti prosedur untuk mengirim Alarm Darurat di radio Anda.

Radio Anda tidak menampilkan indikator audio maupun visual selama mode Darurat bila radio diatur ke Senyap.

1 Tekan tombol terprogram **Darurat Aktif**.

Anda akan melihat salah satu hasil berikut:

- Layar menampilkan **Alarm Tx** dan alias tujuan.
- Layar menampilkan **Telegram Tx** dan alias tujuan.

LED hijau akan menyala. Ikon **Darurat** muncul.



PEMBERITAHUAN:

Jika diprogram, nada Pencarian Darurat akan berbunyi. Nada ini disenyapkan ketika radio memancarkan atau menerima suara, dan berhenti ketika radio keluar dari mode Darurat. Nada Pencarian Darurat dapat diprogram oleh penyalur atau administrator sistem.

2 Tunggu respons.

Jika berhasil:

- Nada Darurat akan berbunyi.
- LED akan berkedip hijau.
- Layar menampilkan **Alarm Terkirim**.

Jika tidak berhasil setelah batas mencoba tercapai:

- Nada akan berbunyi.
- Layar menampilkan **Alarm Gagal**.

Radio keluar dari mode Alarm Darurat dan kembali ke layar Awal.



PEMBERITAHUAN:

Ketika dikonfigurasi untuk Alarm Darurat saja, proses darurat hanya terdiri dari pengiriman Alarm Darurat. Status darurat berakhir bila ada pengakuan yang diterima dari sistem, atau bila jumlah upaya akses saluran telah mencapai batas.

Tidak ada panggilan suara yang dikaitkan dengan pengiriman Alarm Darurat ketika beroperasi sebagai Alarm Darurat Saja.

Mengirim Alarm Darurat dengan Panggilan

Dengan fitur ini Anda bisa mengirim Alarm Darurat dengan Panggilan ke sekelompok radio atau dispatcher. Setelah infrastruktur dalam grup itu memberi respons, sekelompok radio dapat berkomunikasi melalui saluran Darurat terprogram.

Radio harus dikonfigurasi untuk Alarm Darurat dan Panggilan agar dapat melakukan panggilan darurat setelah proses alarm.

1 Tekan tombol **Darurat Aktif** yang diprogram.

Layar menampilkan **Alarm Tx** dan alias tujuan. Ikon **Darurat** muncul. LED hijau akan menyala.



PEMBERITAHUAN:

Jika diprogram, nada Pencarian Darurat akan berbunyi. Nada ini disenyapkan ketika radio memancarkan atau menerima suara, dan berhenti ketika radio keluar dari mode Darurat.

Jika respons Alarm Darurat berhasil diterima:

- Nada Darurat akan berbunyi.
- LED akan berkedip hijau.

- Layar menampilkan **Alarm Terkirim**.
- Radio masuk ke mode panggilan Darurat ketika layar menampilkan **Darurat** dan alias grup tujuan.

Jika respons Alarm Darurat tidak berhasil diterima:

- Upaya mencoba lagi telah digunakan semua.
- Suara bernada rendah akan berbunyi.
- Layar menampilkan **Alarm Gagal**.
- Radio keluar dari mode Alarm Darurat.

2 Tekan tombol **PTT** untuk memulai transmisi suara. LED hijau akan menyala. Layar menampilkan ikon **Panggilan Grup**.

3 Lakukan salah satu langkah berikut:

- Tunggu hingga Nada Izin Bicara selesai dan bicaralah dengan jelas ke mikrofon, jika diaktifkan.
 - Tunggu hingga Sidetone **PTT** selesai dan bicaralah dengan jelas ke mikrofon, jika diaktifkan.
-

- 4 Lepaskan tombol **PTT** untuk mendengarkan.
Layar menampilkan alias pemanggil dan grup.
-

- 5 Jika fitur Indikasi Saluran Bebas diaktifkan, nada peringatan singkat akan berbunyi saat pengguna radio yang melakukan transmisi melepaskan tombol **PTT**, yang menunjukkan saluran bebas dapat Anda gunakan untuk merespons. Tekan tombol **PTT** untuk menjawab panggilan.
-

- 6 Tekan tombol **Darurat Nonaktif** untuk keluar dari mode Darurat.
Radio Anda kembali ke layar Awal.

**PEMBERITAHUAN:**

Bergantung pada bagaimana radio Anda diprogram, Anda mungkin dapat atau tidak dapat mendengar nada Izin Bicara. Dealer radio atau administrator sistem Anda dapat memberikan informasi lebih lanjut tentang bagaimana radio Anda diprogram untuk Darurat.

Pembuat Panggilan Darurat dapat menekan tombol  untuk mengakhiri panggilan darurat yang sedang berlangsung. Radio kembali ke status panggilan diam tetapi layar panggilan darurat tetap terbuka.

Mengirim Alarm Darurat dengan Panduan Suara

Dengan fitur ini Anda bisa mengirim Alarm Darurat dengan Suara untuk diikuti ke sekelompok radio. Mikrofon radio diaktifkan secara otomatis, yang memungkinkan Anda berkomunikasi dengan grup radio tanpa menekan tombol **PTT**. Keadaan mikrofon yang diaktifkan ini disebut *hot mic*.



PEMBERITAHUAN:

Radio Anda tidak dapat mendeteksi mikrofon non-IMPRES yang terpasang ke konektor aksesoris belakang.

Bila tidak ada mikrofon yang terdeteksi pada konektor terprogram yang ditentukan, radio memeriksa konektor alternatif. Di sini, radio memberikan prioritas pada mikrofon yang terdeteksi.

Jika radio Anda telah mengaktifkan Mode Siklus Darurat, pengulangan *hot mic* dan periode penerimaan dilakukan selama durasi yang sudah diprogram. Selama Mode Siklus Darurat, panggilan yang diterima terdengar melalui speaker.

Jika tombol **PTT** ditekan selama jangka waktu penerimaan yang telah diprogram, Anda akan mendengar nada dilarang bicara, yang menunjukkan bahwa Anda harus melepaskan tombol **PTT**. Radio mengabaikan penekanan tombol **PTT** dan tetap dalam mode Darurat.

Jika Anda menekan tombol **PTT** selama *hot mic*, dan terus menekannya setelah durasi *hot mic* habis, radio terus mengirim transmisi sampai Anda melepaskan tombol **PTT**.

Jika permintaan Alarm Darurat gagal, radio tidak mencoba lagi mengirim permintaan, dan langsung masuk ke keadaan *hot mic*.



PEMBERITAHUAN:

Sebagian aksesoris mungkin tidak mendukung *hot mic*. Tanyakan kepada penyalur atau administrator sistem Anda untuk informasi lebih lanjut.

Ikuti prosedur untuk mengirim Alarm Darurat dengan panduan suara di radio Anda.

- 1 Tekan tombol terprogram **Darurat Aktif** atau sakelar kaki **Darurat**.

Anda akan melihat satu dari hasil berikut ini:

- Layar menampilkan Alarm Tx dan alias tujuan.
- Layar menampilkan Telegram Tx dan alias tujuan.

LED hijau akan menyala. Ikon **Darurat** muncul.

-
- 2 Setelah layar menampilkan Alarm Terkirim, berbicaralah dengan jelas ke mikrofon.

Radio menghentikan transmisi secara otomatis apabila:

- Setelah durasi siklus antara *hot mic* dan menerima panggilan habis, jika Mode Siklus Darurat diaktifkan.

- Setelah durasi *hot mic* habis, jika Mode Siklus Darurat dinonaktifkan.

3 Tekan tombol **Darurat Nonaktif** untuk keluar dari mode Darurat.

Radio kembali ke layar Awal.

Menerima Alarm Darurat



Radio penerima hanya dapat mendukung satu Alarm Darurat dalam satu waktu. Jika dimulai, Alarm Darurat kedua akan menimpa alarm pertama. Ikuti prosedur untuk menerima dan melihat Alarm Darurat di radio Anda.

Ketika Anda menerima Alarm Darurat:

- Nada akan berbunyi.
- LED merah berkedip.
- Layar menampilkan Daftar Alarm Darurat, ID atau alias Grup Bicara Darurat, dan ID atau alias radio pemancar.

1 Tekan  untuk melihat alarm.

2 Tekan  untuk melihat opsi tindakan dan detail entri di Daftar Alarm.

3 Tekan  dan pilih  untuk keluar dari Daftar alarm.

Radio akan kembali ke layar awal dengan **Ikona Darurat** ditampilkan di bagian atas, yang menunjukkan Alarm Darurat yang belum ditangani. **Ikona Darurat** akan hilang setelah entri di Daftar Alarm dihapus.

4 Tekan  untuk mengakses menu.

5 Pilih **Daftar Alarm** untuk kembali ke daftar Alarm.

6 Nada berbunyi dan LED merah berkedip sampai Anda keluar dari mode Darurat. Namun, nada tersebut dapat dimatikan. Lakukan salah satu langkah berikut:

- Tekan tombol **PTT** untuk memanggil grup radio yang menerima Alarm Darurat.
- Tekan sembarang tombol yang dapat diprogram.

Merespons Alarm Darurat

Ketika radio menerima Alarm Darurat, penerima dapat memilih untuk menghapus alarm dan keluar dari Daftar Alarm, atau merespons Alarm Darurat dengan menekan tombol **PTT** dan memancarkan suara non-darurat. Ikuti prosedur untuk merespons Panggilan Darurat di radio Anda.

- 1 Jika Indikasi Alarm Darurat diaktifkan, Daftar Alarm Darurat muncul saat radio menerima Alarm Darurat.

Tekan  atau  ke alias atau ID yang diinginkan.

- 2 Jika fitur Indikasi Saluran Bebas diaktifkan, nada peringatan singkat akan berbunyi saat pengguna radio yang melakukan transmisi melepaskan tombol **PTT**, yang menunjukkan saluran bebas dapat Anda gunakan untuk merespons. Tekan tombol **PTT** untuk melakukan transmisi suara non-darurat ke grup yang sama dengan target Alarm Darurat.

LED hijau akan menyala.

- 3 Lakukan salah satu langkah berikut:

- Tunggu hingga Nada Izin Bicara selesai dan bicaralah dengan jelas ke mikrofon, jika diaktifkan.
- Tunggu hingga Sidetone **PTT** selesai dan bicaralah dengan jelas ke mikrofon, jika diaktifkan.

- 4 Lepaskan tombol **PTT** untuk mendengarkan.

Ketika radio yang memulai darurat merespons:

- LED merah berkedip.
- Layar menampilkan ikon **Panggilan Darurat**, ID atau alias Grup Bicara Darurat, dan ID atau alias radio pemancar.



PEMBERITAHUAN:

Jika Indikasi Panggilan Darurat tidak diaktifkan, layar menampilkan ikon **Panggilan Grup**, ID atau alias Grup Bicara Darurat, dan ID atau alias radio pemancar.

Merespons Alarm Darurat dengan Panggilan

Ikuti prosedur untuk merespons Alarm Darurat dengan Panggilan di radio Anda.

Ketika Anda menerima Panggilan Darurat:

- Nada Panggilan Darurat berbunyi jika Indikasi Panggilan Darurat dan Nada Dekode Panggilan Darurat diaktifkan. Nada Panggilan Darurat tidak akan berbunyi jika hanya Indikasi Panggilan Darurat yang diaktifkan.
 - Layar menampilkan ikon **Panggilan Darurat** di sudut kanan atas.
 - Baris teks menunjukkan ID atau alias Grup Bicara Darurat dan ID atau alias radio pemancar.
 - Radio bersuara dan panggilan masuk berbunyi melalui speaker.
- 1 Jika fitur Indikasi Saluran Bebas diaktifkan, nada peringatan singkat akan berbunyi saat pengguna radio yang melakukan transmisi melepaskan tombol **PTT**, yang menunjukkan saluran bebas dapat Anda

gunakan untuk merespons. Tekan tombol **PTT** untuk menjawab panggilan.

LED hijau akan menyala.

-
- 2 Tunggu hingga Nada Izin Bicara selesai dan bicaralah dengan jelas ke mikrofon, jika diaktifkan.

-
- 3 Lepaskan tombol **PTT** untuk mendengarkan.

Ketika radio yang memulai darurat merespons:

- LED merah berkedip.
- Layar menampilkan ikon **Panggilan Darurat**, ID atau alias Grup Bicara Darurat, dan ID atau alias radio pemancar.



PEMBERITAHUAN:

Jika Indikasi Panggilan Darurat tidak diaktifkan, layar menampilkan ikon **Panggilan Grup**, ID atau alias Grup Bicara Darurat, dan ID atau alias radio pemancar.

Pesan Status

Fitur ini memungkinkan pengguna untuk mengirim pesan status ke radio lain.

Daftar Status Cepat dikonfigurasi menggunakan CPS-RM dan berisi hingga maksimal 99 status.

Panjang maksimal tiap pesan status adalah 16 karakter.



PEMBERITAHUAN:



Setiap status memiliki nilai digital yang sesuai dengan rentang antara 0–99. Alias dapat ditetapkan ke setiap status untuk referensi yang mudah.

Mengirim Pesan Status



Ikuti prosedur berikut untuk mengirim pesan status.

- 1 Lakukan salah satu langkah berikut:
 - Tekan tombol **Akses Satu Sentuhan** terprogram. Lompati langkah-langkah berikut ini.
 - Tekan  untuk mengakses menu.

- 2 Tekan  atau  ke Status. Tekan  untuk memilih.

- 3 Tekan  atau  ke Status Cepat. Tekan  untuk memilih.

- 4 Tekan  atau  ke pesan status yang diinginkan. Tekan  untuk memilih.

- 5 Tekan  atau  ke alias atau ID subscriber, atau alias atau ID grup yang diinginkan. Tekan  untuk memilih.

Jika berhasil:

- Nada indikator positif akan berbunyi.
- LED mati.
- Layar menampilkan pemberitahuan mini positif sebelum kembali ke layar Status Cepat.
- Layar menampilkan  di sebelah pesan status yang dikirim.



Jika tidak berhasil:



- Nada indikator negatif akan berbunyi.
- LED mati.
- Layar menampilkan pemberitahuan kegagalan sebelum kembali ke layar Status Cepat.

Mengirim Pesan Status Menggunakan Tombol yang Dapat Diprogram

Ikuti panduan pengiriman pesan status menggunakan tombol yang dapat diprogram.

1 Tekan tombol **Pesan Status** terprogram.

2 Tekan  atau  ke pesan status yang diinginkan. Tekan  untuk memilih. Daftar kontak ditampilkan

3 Tekan  atau  ke alias atau ID subscriber, atau alias atau ID grup yang diinginkan. Tekan  untuk memilih.

Jika berhasil:

- Nada indikator positif akan berbunyi.
- LED mati.
- Layar menampilkan pemberitahuan mini positif sebelum kembali ke layar *Status Cepat*.
- Layar menampilkan  di sebelah status yang dikirim.

Jika tidak berhasil:



- Nada indikator negatif akan berbunyi.
- LED mati.
- Layar menampilkan pemberitahuan kegagalan sebelum kembali ke layar *Status Cepat*.



Mengirim Pesan Status Menggunakan Daftar Kontak

Ikuti prosedur untuk mengirim pesan status radio menggunakan daftar kontak.

1 Tekan  untuk mengakses menu.

2 Tekan  atau  ke *Kontak*. Tekan  untuk memilih.

3 Tekan  atau  ke alias atau ID subscriber, atau alias atau ID grup yang diinginkan. Tekan  untuk memilih.

4 Tekan  atau  ke Kirim Status. Tekan  untuk memilih.

5 Tekan  atau  ke pesan status yang diinginkan. Tekan  untuk memilih.

Jika berhasil:

- Nada indikator positif akan berbunyi.
- LED mati.
- Layar menampilkan pemberitahuan mini positif sebelum kembali ke layar Status Cepat.
- Layar menampilkan  di sebelah status yang dikirim.

Jika tidak berhasil:

- Nada indikator negatif akan berbunyi.
- LED mati.
- Layar menampilkan pemberitahuan kegagalan sebelum kembali ke layar Status Cepat.



Mengirim Pesan Status Menggunakan Panggilan Manual

Ikuti prosedur untuk mengirim pesan status menggunakan panggilan manual.



1 Tekan  untuk mengakses menu.

2 Tekan  atau  ke Kontak. Tekan  untuk memilih.

3 Tekan  atau  ke Panggilan Manual. Tekan  untuk memilih.

4 Tekan  atau  ke Nomor Radio. Tekan  untuk memilih.

5 Masukkan alias atau ID subscriber, atau alias atau ID grup, lalu tekan  untuk melanjutkan.

6 Tekan  atau  ke Kirim Status. Tekan  untuk memilih.

7 Tekan  atau  ke pesan status yang diinginkan. Tekan  untuk memilih.

Jika berhasil:

- Nada indikator positif akan berbunyi.
- LED mati.
- Layar menampilkan pemberitahuan mini positif sebelum kembali ke layar Status Cepat.
- Layar menampilkan  di sebelah status yang dikirim.

Jika tidak berhasil:



- Nada indikator negatif akan berbunyi.
- LED mati.
- Layar menampilkan pemberitahuan kegagalan sebelum kembali ke layar Status Cepat.



Melihat Pesan Status

Ikuti prosedur untuk melihat pesan status.

1 Tekan  untuk mengakses menu.

2 Tekan  atau  ke Status. Tekan  untuk memilih.

3 Tekan  atau  ke Kotak Masuk. Tekan  untuk memilih.

4 Tekan  atau  ke pesan status yang diinginkan. Tekan  untuk memilih.
Isi pesan status ditampilkan kepada pengguna radio.

Pesan status yang diterima juga dapat dilihat dengan mengakses Daftar Notifikasi. Lihat [Daftar Notifikasi di halaman 194](#) untuk informasi selengkapnya.

Menanggapi Pesan Status

Ikuti prosedur untuk membalas pesan status.

1 Tekan  untuk mengakses menu.

2 Tekan  atau  ke Status. Tekan  untuk memilih.

3 Tekan  atau  ke Kotak Masuk. Tekan  untuk memilih.

4 Tekan  atau  ke pesan status yang diinginkan. Tekan  untuk memilih.

5 Isi status akan ditampilkan. Tekan  untuk memilih.

6 Tekan  atau  ke Balas. Tekan  untuk memilih.

7 Tekan  atau  ke pesan status yang diinginkan. Tekan  untuk memilih.

Jika berhasil:

- Nada indikator positif akan berbunyi.

- LED mati.
- Layar menampilkan pemberitahuan mini positif sebelum kembali ke layar Kotak Masuk.
- Layar menampilkan  di sebelah status yang dikirim.

Jika tidak berhasil:



- Nada indikator negatif akan berbunyi.
- LED mati.
- Layar menampilkan pemberitahuan mini positif sebelum kembali ke layar Kotak Masuk.



Menghapus Pesan Status

Ikuti prosedur untuk menghapus pesan status dari radio Anda.

1 Tekan  untuk mengakses menu.

2 Tekan  atau  ke Status. Tekan  untuk memilih.

3 Tekan  atau  ke Kotak Masuk. Tekan  untuk memilih.

4 Tekan  atau  ke pesan status yang diinginkan. Tekan  untuk memilih.

5 Isi status akan ditampilkan. Tekan  untuk memilih.

6 Tekan  atau  ke Hapus. Tekan  untuk memilih.

7 Tekan  atau  ke Ya. Tekan  untuk memilih.



- Layar menampilkan pemberitahuan mini positif sebelum kembali ke layar Kotak Masuk.



Menghapus Semua Pesan Status

Ikuti prosedur untuk menghapus semua pesan status dari radio Anda.

1 Tekan  untuk mengakses menu.

2 Tekan  atau  ke Status. Tekan  untuk memilih.

3 Tekan  atau  ke Kotak Masuk. Tekan  untuk memilih.

4 Tekan  atau  ke Hapus Semua. Tekan  untuk memilih.

5 Tekan  atau  ke Ya. Tekan  untuk memilih.

- Layar menampilkan Daftar Kosong.

Pengolahan Pesan Teks

Radio Anda mampu menerima data, misalnya pesan teks, dari radio lain atau aplikasi pesan teks.

Ada dua jenis pesan teks, Pesan Teks Singkat Radio Mobile Digital (DMR) dan pesan teks. Panjang maksimal

Pesan Teks Singkat DMR adalah 23 karakter. Panjang maksimum pesan teks adalah 280 karakter, termasuk baris subjek. Baris subjek hanya muncul saat Anda menerima pesan dari aplikasi email.



PEMBERITAHUAN:

Panjang karakter maksimum hanya berlaku untuk model dengan perangkat lunak dan perangkat keras terbaru. Untuk model radio dengan perangkat lunak dan perangkat keras lama, panjang maksimum pesan teks adalah 140 karakter. Tanyakan kepada penyalur atau administrator sistem Anda untuk informasi lebih lanjut.

Pesan Teks

Pesan teks disimpan di Kotak Masuk, dan diurutkan sesuai pesan yang paling baru.

Radio keluar dari layar saat ini setelah pencatat waktu nonaktif berakhir. Untuk kembali ke layar Awal, tekan lama

 kapan saja.

Melihat Pesan Teks

Ikuti prosedur untuk melihat pesan teks di radio Anda.



1 Tekan  untuk mengakses menu.

2 Tekan  atau  ke Pesan. Tekan  untuk memilih.

3 Tekan  atau  ke Kotak Masuk. Tekan  untuk memilih.

Jika Kotak Masuk kosong:

- Layar menampilkan Daftar Kosong.
 - Nada akan berbunyi jika Nada Keypad diaktifkan.
-



4 Tekan  atau  ke pesan yang diinginkan. Tekan  untuk memilih.



Layar menampilkan baris subjek jika pesan berasal dari aplikasi e-mail.



Melihat Pesan Teks Status Telemetri

Ikuti prosedur untuk melihat pesan teks status telemetri dari Kotak Masuk.

- 1 Tekan  untuk mengakses menu.

- 2 Tekan  atau  ke Pesan. Tekan  untuk memilih.

- 3 Tekan  atau  ke Kotak Masuk. Tekan  untuk memilih.

- 4 Tekan  atau  ke pesan yang diperlukan. Tekan  untuk memilih.
Anda tidak dapat membalas pesan teks Status Telemetry.
Layar akan menampilkan Telemetry: <Pesan Teks Status>.

- 5 Tekan lama  untuk kembali ke layar Awal.

Merespons Pesan Teks

Ikuti prosedur untuk merespons pesan teks di radio Anda.









Ketika Anda menerima pesan teks:

- Layar menampilkan daftar Notifikasi disertai alias atau ID pengirim.
- Layar menampilkan ikon **Pesan**.





PEMBERITAHUAN:

Radio keluar dari layar peringatan pesan teks dan menyiapkan Panggilan Pribadi atau Grup ke pengirim pesan jika tombol **PTT** ditekan.

- 1 Lakukan salah satu langkah berikut:
 - Tekan  atau  ke Baca. Tekan  untuk memilih.
Layar menampilkan pesan teks. Layar menampilkan baris subjek jika pesan berasal dari aplikasi e-mail.
 - Tekan  atau  ke Baca Nanti. Tekan  untuk memilih.
Radio kembali ke layar yang dibuka sebelum Anda menerima pesan teks.
 - Tekan  atau  ke Hapus. Tekan  untuk memilih.

2 Lakukan salah satu langkah berikut:

- Tekan  untuk kembali ke Kotak Masuk.
 - Tekan  sekali lagi untuk membalas, meneruskan, atau menghapus pesan teks.
-

Merespans Pesan Teks dengan Teks Cepat



Ikuti prosedur untuk merespons pesan teks dengan pesan Teks Cepat di radio Anda.

1 Lakukan salah satu langkah berikut:

- Tekan tombol **Pesan Teks** terprogram. Lanjutkan ke Langkah 3.
 - Tekan  untuk mengakses menu.
-



2 Tekan  atau  ke **Pesan**. Tekan  untuk memilih.

3 Tekan  atau  ke **Kotak Masuk**. Tekan  untuk memilih.

4 Tekan  atau  ke pesan yang diinginkan. Tekan  untuk memilih.
Layar menampilkan baris subjek jika pesan berasal dari aplikasi e-mail.

5 Tekan  untuk mengakses sub-menu.

6 Tekan  atau  ke **Balas**. Tekan  untuk memilih.

7 Tekan  atau  ke **Balas Cepat**. Tekan  untuk memilih.

8 Tekan  atau  ke pesan yang diinginkan.

Tekan  untuk memilih.

Layar menampilkan pemberitahuan mini transisional, yang mengonfirmasi bahwa pesan sedang dikirim.

9 Tunggu respons.

Jika berhasil:

- Nada akan berbunyi.
- Layar menampilkan pemberitahuan mini positif.

Jika tidak berhasil:

- Nada akan berbunyi.
 - Layar menampilkan pemberitahuan mini negatif.
 - Radio kembali ke layar opsi Kirim Ulang.
-

Mengirim Ulang Pesan Teks

Ikuti prosedur untuk mengirim ulang pesan teks di radio Anda.

Ketika berada di layar opsi Kirim Ulang:

Tekan  untuk mengirim ulang pesan yang sama ke alias atau ID subscriber atau grup yang sama.

Jika berhasil:

- Nada indikator positif akan berbunyi.
- Layar menampilkan pemberitahuan mini positif.



Jika tidak berhasil:



- Nada indikator negatif akan berbunyi.
 - Layar menampilkan pemberitahuan mini negatif.
 - Radio kembali ke layar opsi Kirim Ulang.
-

Meneruskan Pesan Teks

Ikuti prosedur untuk meneruskan pesan teks di radio Anda.

Ketika berada di layar opsi Kirim Ulang:

- 1 Tekan  atau  ke Teruskan, dan tekan  untuk mengirim pesan yang sama ke alias atau ID subscriber atau grup.
-

- 2 Tekan  atau  ke alias atau ID yang diinginkan. Tekan  untuk memilih. Layar menampilkan pemberitahuan mini transisional, yang mengonfirmasi bahwa pesan sedang dikirim.
-

- 3 Tunggu respons.

Jika berhasil:

- Nada akan berbunyi.
- Layar menampilkan pemberitahuan mini positif.

Jika tidak berhasil:

- Nada akan berbunyi.
- Layar menampilkan pemberitahuan mini negatif.



PEMBERITAHUAN:



Anda juga dapat memilih alamat radio target secara manual (lihat [Meneruskan Pesan Teks Menggunakan Panggilan Manual di halaman 450](#)).

Meneruskan Pesan Teks Menggunakan Panggilan Manual

Ikuti prosedur untuk meneruskan pesan teks menggunakan panggilan manual di radio Anda.

- 1 Tekan  atau  ke Teruskan. Tekan  untuk memilih.
-

- 2 Tekan  untuk mengirim pesan yang sama ke alias atau ID grup atau subscriber lain.
-

- 3 Tekan  atau  ke Panggilan Manual. Tekan  untuk memilih. Layar menampilkan Nomor Radio:.
-

- 4 Masukkan ID subscriber, lalu tekan  untuk melanjutkan. Layar menampilkan pemberitahuan mini transisional, yang mengonfirmasi bahwa pesan sedang dikirim.
-

5 Tunggu respons.

Jika berhasil:

- Nada akan berbunyi.
- Layar menampilkan pemberitahuan mini positif.

Jika tidak berhasil:

- Nada akan berbunyi.
- Layar menampilkan pemberitahuan mini negatif.

Mengedit Pesan Teks

Pilih **Edit** untuk mengedit pesan.







PEMBERITAHUAN:

Jika terdapat baris subjek (untuk pesan yang diterima dari aplikasi email), Anda tidak dapat mengeditnya.

- 1 Tekan  atau  ke **Edit**. Tekan  untuk memilih.







Layar menampilkan kursor berkedip.

- 2 Gunakan keypad untuk mengedit pesan.

- Tekan  untuk bergerak satu spasi ke kiri.
- Tekan  atau  untuk bergerak satu spasi ke kanan.
- Tekan  untuk menghapus karakter yang tidak diinginkan.
- Tekan lama  untuk mengganti metode entri teks.

- 3 Tekan  setelah selesai membuat pesan.

- 4 Lakukan salah satu langkah berikut:

- Tekan  atau  ke **Kirim** dan tekan  untuk mengirim pesan.
- Tekan  atau  ke **Simpan** dan tekan  untuk menyimpan pesan ke folder Konsep.
- Tekan  untuk mengedit pesan.

- Tekan  untuk memilih antara menghapus pesan atau menyimpannya di folder Konsep.
-

Menulis Pesan Teks

Ikuti prosedur untuk menulis pesan teks di radio Anda.

- 1 Lakukan salah satu langkah berikut:
 - Tekan tombol **Pesan Teks** terprogram. Lanjutkan ke [langkah 3](#).
 - Tekan  untuk mengakses menu.
-



- 2 Tekan  atau  ke **Pesan**. Tekan  untuk memilih.
-

- 3 Tekan  atau  ke **Tulis**. Tekan  untuk memilih.

Kursor berkedip akan ditampilkan.

- 4 Gunakan keypad untuk mengetik pesan.

Tekan  untuk bergerak satu spasi ke kiri.





Tekan  atau  untuk bergerak satu spasi ke kanan.

Tekan  untuk menghapus karakter yang tidak diinginkan.

Tekan lama  untuk mengganti metode entri teks.

- 5 Tekan  setelah selesai membuat pesan.

Lakukan salah satu langkah berikut:





- Tekan  untuk mengirim pesan.
 - Tekan . Tekan  atau  untuk memilih antara mengedit, menghapus, atau menyimpan pesan. Tekan  untuk memilih.
-

Mengirim Pesan Teks

Ikuti prosedur untuk mengirim pesan teks di radio Anda.

Dalam prosedur ini Anda dianggap memiliki pesan teks yang baru ditulis atau pesan teks tersimpan.

Pilih penerima pesan. Lakukan salah satu langkah berikut:

- Tekan  atau  ke alias atau ID yang diperlukan. Tekan  untuk memilih.
- Tekan  atau  ke Panggilan Manual.

Tekan  untuk memilih. Masukkan ID subscriber. Baris pertama layar menampilkan Radio Number: (Nomor Radio:). Baris kedua layar menampilkan kursor yang berkedip.

Masukkan alias atau ID subscriber. Tekan .

Layar akan menampilkan pemberitahuan mini sementara, yang mengonfirmasi bahwa pesan Anda sedang dikirim.

Jika berhasil:

- Nada akan berbunyi.
- Layar menampilkan pemberitahuan mini positif.

Jika tidak berhasil:

- Nada rendah akan terdengar.
- Layar menampilkan pemberitahuan mini negatif.

- Pesan dipindah ke folder Item Terkirim.
- Pesan ditandai dengan ikon Gagal Terkirim.



PEMBERITAHUAN:

Untuk pesan teks yang baru ditulis, radio kembali ke layar opsi Kirim Ulang.



Menghapus Pesan Teks dari Kotak Masuk

Ikuti prosedur untuk menghapus pesan teks dari Kotak Masuk di radio Anda.

1 Lakukan salah satu langkah berikut:

- Tekan tombol **Pesan Teks** terprogram. Lanjutkan ke [langkah 3](#).
- Tekan  untuk mengakses menu.

2

Tekan  atau  ke Pesan. Tekan  untuk memilih.

3

Tekan  atau  ke Kotak Masuk. Tekan  untuk memilih.

Jika Kotak Masuk kosong:

- Layar menampilkan Daftar Kosong.
- Nada akan berbunyi.

4 Tekan  atau  ke pesan yang diperlukan.

Tekan  untuk memilih.

Layar menampilkan baris subjek jika pesan berasal dari aplikasi e-mail.

5 Tekan  untuk mengakses sub-menu.

6 Tekan  atau  ke Hapus. Tekan  untuk memilih.

7 Tekan  atau  ke Ya. Tekan  untuk memilih.

Layar menampilkan pemberitahuan mini positif.
Layar kembali ke Kotak Masuk.

Menghapus Semua Pesan Teks dari Kotak Masuk

Ikuti prosedur untuk menghapus semua pesan teks dari Kotak Masuk di radio Anda.

1 Lakukan salah satu langkah berikut:



- Tekan tombol **Pesan Teks** terprogram. Lanjutkan ke [langkah 3](#).
- Tekan  untuk mengakses menu.



2 Tekan  atau  ke Pesan. Tekan  untuk memilih.

3 Tekan  atau  ke Kotak Masuk. Tekan  untuk memilih.

Jika Kotak Masuk kosong:

- Layar menampilkan Daftar Kosong.
 - Nada akan berbunyi.
-

4 Tekan  atau  ke Hapus Semua. Tekan  untuk memilih.

5 Tekan  atau  ke Ya. Tekan  untuk memilih.
Layar menampilkan pemberitahuan mini positif.

Pesan Teks Terkirim

Setelah terkirim ke radio lain, pesan akan disimpan di folder Item Terkirim. Pesan teks terkirim terbaru selalu ditambahkan ke bagian teratas di folder Item Terkirim. Anda dapat mengirim ulang, meneruskan, mengedit, atau menghapus pesan teks Terkirim.

Folder Item Terkirim mampu menyimpan maksimal 30 pesan terakhir yang terkirim. Ketika folder penuh, pesan teks terkirim berikutnya akan otomatis menggantikan pesan teks terlama di folder itu.

Jika Anda keluar dari layar pengiriman pesan teks ketika pesan sedang dikirimkan, radio memperbarui status pesan dalam folder Item Terkirim tanpa memberikan indikasi apa pun di layar atau melalui suara.

Jika radio berganti mode atau mati sebelum status pesan di Item Terkirim diperbarui, radio tidak akan dapat menyelesaikan pesan Dalam Proses apa pun dan otomatis menandainya dengan ikon **Gagal Terkirim**.

Radio mendukung maksimal lima pesan Sedang Berlangsung dalam satu waktu. Selama periode ini, radio tidak dapat mengirimkan pesan baru apa pun dan otomatis menandainya dengan ikon **Gagal Terkirim**.

Jika tombol  ditekan lama kapan saja, radio kembali ke layar Awal.



PEMBERITAHUAN:

Jika jenis saluran, misalnya saluran digital konvensional atau Capacity Plus, tidak cocok, Anda hanya dapat mengedit, meneruskan, atau menghapus Pesan terkirim.



Melihat Pesan Teks Terkirim

Ikuti prosedur untuk melihat pesan teks terkirim di radio Anda.

- 1 Lakukan salah satu langkah berikut:
 - Tekan tombol **Pesan Teks** terprogram. Lanjutkan ke [langkah 3](#).



- Tekan  untuk mengakses menu.

2 Tekan  atau  ke Pesan. Tekan  untuk memilih.

3 Tekan  atau  ke Item Terkirim. Tekan  untuk memilih.

Jika folder Item Terkirim kosong:

- Layar menampilkan Daftar Kosong.
- Nada rendah akan berbunyi jika Nada Keypad diaktifkan.

4 Tekan  atau  ke pesan yang diinginkan. Tekan  untuk memilih.

Ikon di sudut kanan atas layar menunjukkan status pesan. Lihat [Ikon Item Terkirim](#).



Mengirim Pesan Teks Terkirim

Ikuti prosedur untuk mengirim sebuah pesan teks terkirim di radio Anda.

Ketika Anda melihat pesan Terkirim:

1 Tekan  .

2 Anda dapat mengirim ulang atau meneruskan pesan teks terkirim. Lakukan salah satu langkah berikut:

-  ke Kirim Ulang. Tekan  untuk memilih.

-  ke Teruskan. Tekan  untuk memilih.

Layar menampilkan pemberitahuan mini transisional, yang mengonfirmasi bahwa pesan sedang dikirim.

3 Tunggu respons.

Jika berhasil:

- Nada akan berbunyi.
- Layar menampilkan pemberitahuan mini positif.





Jika tidak berhasil:

- Nada akan berbunyi.
- Layar menampilkan pemberitahuan mini negatif.
- Radio masuk ke layar opsi Kirim Ulang. Lihat [Mengirim Ulang Pesan Teks di halaman 157](#) untuk informasi selengkapnya.

Menghapus Pesan Teks Terkirim dari folder Item Terkirim







Ikuti prosedur untuk menghapus pesan teks terkirim dari folder Item Terkirim di radio Anda.

Ketika Anda melihat pesan Terkirim:

- 1 Tekan .
-
- 2 Tekan  atau  ke Hapus. Tekan  untuk memilih.
-



Menghapus Semua Pesan Teks Terkirim dari folder Item Terkirim

Ikuti prosedur untuk menghapus semua pesan teks terkirim dari folder Item Terkirim di radio Anda.







- 1 Lakukan salah satu langkah berikut:
 - Tekan tombol **Pesan Teks** terprogram. Lanjutkan ke [langkah 3](#).
 - Tekan  untuk mengakses menu.
-
- 2 Tekan  atau  ke Pesan. Tekan  untuk memilih.
-
- 3 Tekan  atau  ke Item Terkirim. Tekan  untuk memilih.

Jika folder Item Terkirim kosong:

 - Layar menampilkan Daftar Kosong.
 - Nada akan berbunyi.
-

- 4 Tekan  atau  ke Hapus Semua. Tekan  untuk memilih.
-

5 Lakukan salah satu langkah berikut:

- Tekan  atau  ke Ya. Tekan  untuk memilih.
Layar menampilkan pemberitahuan mini positif.
 - Tekan  atau  ke Tidak. Tekan  untuk memilih.
Radio kembali ke layar sebelumnya.
-

Pesan SMS Tersimpan

Anda dapat menyimpan pesan SMS untuk mengirimkannya nanti.

Jika penekanan tombol **PTT** atau perubahan mode mengakibatkan radio keluar dari layar penulisan/ pengeditan sewaktu Anda menulis atau mengedit pesan teks, maka pesan teks tersebut akan secara otomatis disimpan ke folder Konsep.

Pesan SMS yang paling baru disimpan selalu ditambahkan di bagian atas daftar Draf.

Folder Draf menyimpan maksimum 10 pesan terakhir yang disimpan. Saat folder penuh, pesan SMS yang berikutnya disimpan akan otomatis menggantikan pesan SMS terlama dalam folder.

Melihat Pesan Teks Tersimpan



Ikuti prosedur untuk melihat pesan teks tersimpan di radio Anda.

1 Lakukan salah satu langkah berikut:

- Tekan tombol **Pesan Teks** terprogram. Lanjutkan ke [langkah 3](#).
 - Tekan  untuk mengakses menu.
-







2 Tekan  atau  ke Pesan. Tekan  untuk memilih.

3 Tekan  atau  ke Konsep. Tekan  untuk memilih.

- 4 Tekan  atau  ke pesan yang diperlukan.
Tekan  untuk memilih.
-

Mengedit Pesan Teks Tersimpan

Ikuti prosedur untuk mengedit pesan teks tersimpan di radio Anda.







- 1 Tekan  saat melihat pesan.
-
- 2 Tekan  atau  ke Edit. Tekan  untuk memilih.
Kursor berkedip akan ditampilkan.
-
- 3 Gunakan keypad untuk mengetik pesan.
- Tekan  untuk bergerak satu spasi ke kiri.
- Tekan  atau  untuk bergerak satu spasi ke kanan.

Tekan  untuk menghapus karakter yang tidak diinginkan.

Tekan lama  untuk mengganti metode entri teks.

- 4 Tekan  setelah selesai membuat pesan.

Lakukan salah satu langkah berikut:

- Tekan  atau  ke Kirim. Tekan  untuk mengirim pesan.
 - Tekan . Tekan  atau  untuk memilih antara menyimpan atau menghapus pesan. Tekan  untuk memilih.
-

Menghapus Pesan Teks Tersimpan dari Folder Konsep



Ikuti prosedur untuk menghapus pesan teks tersimpan dari konsep di radio Anda.



- 1 Lakukan salah satu langkah berikut:

- Tekan tombol **Pesan Teks** terprogram. Lanjutkan ke [langkah 3](#).
- Tekan  untuk mengakses menu.

2 Tekan  atau  ke **Pesan**. Tekan  untuk memilih.

3 Tekan  atau  ke **Konsep**. Tekan  untuk memilih.

4 Tekan  atau  ke pesan yang diperlukan.
Tekan  untuk memilih.

5 Tekan  atau  ke **Hapus**. Tekan  untuk menghapus pesan teks.

Pesan Teks Cepat

Radio Anda mendukung maksimal 50 pesan Teks Cepat sebagaimana diprogram oleh dealer.

Meskipun isi pesan Teks Cepat telah ditentukan sebelumnya, Anda dapat mengedit setiap pesan sebelum mengirimnya.

Mengirim Pesan Teks Cepat

Ikuti prosedur untuk mengirim pesan Teks Cepat yang sudah ditentukan sebelumnya di radio Anda ke alias yang sudah ditentukan sebelumnya.

1 Lakukan salah satu langkah berikut:



- Tekan tombol **Pesan Teks** terprogram. Lanjutkan ke [langkah 3](#).
- Tekan tombol **Akses Satu Sentuhan** terprogram. Lanjutkan ke [langkah 6](#).

Layar menampilkan pemberitahuan mini transisional, yang mengonfirmasi bahwa pesan sedang dikirim.

- Tekan  untuk mengakses menu.

2 Tekan  atau  ke **Pesan**. Tekan  untuk memilih.

3 Tekan  atau  ke Teks Cepat. Tekan  untuk memilih.

4 Tekan  atau  ke pesan Teks Cepat yang diperlukan. Tekan  untuk memilih.

5 Lakukan hal berikut untuk memilih penerima dan mengirim pesan.

Layar menampilkan pemberitahuan mini transisional, yang mengonfirmasi bahwa pesan sedang dikirim.

6 Tunggu respons.

Jika berhasil:

- Nada indikator positif akan berbunyi.
- Layar menampilkan pemberitahuan mini positif.

Jika tidak berhasil:

- Nada indikator negatif akan berbunyi.
- Layar menampilkan pemberitahuan mini negatif.

- Radio masuk ke layar opsi Kirim Ulang. Lihat [Mengirim Ulang Pesan Teks di halaman 157](#) untuk informasi selengkapnya.
-

Konfigurasi Entri Teks

Radio ini memungkinkan Anda mengonfigurasi teks yang berbeda.

Anda dapat mengonfigurasi pengaturan berikut untuk memasukkan teks di radio Anda:



- Prediksi Kata
- Koreksi Kata
- Kapitalisasi Kalimat
- Kata Saya

Radio Anda mendukung metode entri teks berikut:

- Angka
- Simbol
- Prediktif atau Multisentuh
- Bahasa (Jika diprogram)







PEMBERITAHUAN:



Tekan  kapan saja untuk kembali ke layar sebelumnya atau tekan lama  untuk kembali ke Layar Awal. Radio keluar dari layar saat ini setelah pencatat waktu nonaktif berakhir.

Mengaktifkan atau Menonaktifkan Koreksi Kata



Menyediakan pilihan kata alternatif saat kata yang dimasukkan ke dalam editor teks tidak dikenali oleh kamus yang ada di dalamnya.







- 1 Tekan  untuk mengakses menu.

- 2 Tekan  atau  ke Utilitas. Tekan  untuk memilih.

- 3 Tekan  atau  ke Pengaturan Radio. Tekan  untuk memilih.

- 4 Tekan  atau  ke Entri Teks. Tekan  untuk memilih.

- 5 Tekan  atau  ke Koreksi Kata. Tekan  untuk memilih.



- 6 Lakukan salah satu langkah berikut:
 - Tekan  atau  ke Koreksi Kata. Tekan  untuk memilih.
 - Tekan  untuk mengaktifkan Koreksi Kata. Jika diaktifkan,  muncul di sebelah Diaktifkan.
 - Tekan  untuk menonaktifkan Koreksi Kata. Jika dinonaktifkan,  hilang dari sebelah Diaktifkan.



Mengaktifkan atau Menonaktifkan Prediksi Kata



Prediksi Kata: Radio Anda bisa mempelajari urutan kata umum yang sering Anda masukkan. Kemudian memprediksi kata berikutnya yang mungkin ingin Anda



gunakan setelah memasukkan kata pertama dari urutan kata umum ke dalam editor teks.

- 1 Tekan  untuk mengakses menu.

- 2 Tekan  atau  ke *Utilitas*. Tekan  untuk memilih.

- 3 Tekan  atau  ke *Pengaturan Radio*. Tekan  untuk memilih.

- 4 Tekan  atau  ke *Entri Teks*. Tekan  untuk memilih.

- 5 Tekan  atau  ke *Prediksi Kata*. Tekan  untuk memilih.



- 6 Lakukan salah satu langkah berikut:
 - Tekan  untuk mengaktifkan *Prediksi Kata*. Jika diaktifkan, ✓ muncul di sebelah *Diaktifkan*.



- Tekan  untuk menonaktifkan *Kontrol Distorsi Dinamis Mikrofon*. Jika dinonaktifkan, ✓ hilang dari sebelah *Diaktifkan*.



Kapitalisasi Kalimat



Fitur ini digunakan untuk mengaktifkan kapitalisasi secara otomatis untuk huruf awal kata pertama pada setiap kalimat baru.

- 1 Tekan  untuk mengakses menu.



- 2 Tekan  atau  ke *Utilitas*. Tekan  untuk memilih.

- 3 Tekan  atau  ke *Pengaturan Radio*. Tekan  untuk memilih.

- 4 Tekan  atau  ke *Entri Teks*. Tekan  untuk memilih.

5 Tekan  atau  ke Kapitalisasi Kalimat. Tekan  untuk memilih.

6 Lakukan salah satu langkah berikut:

- Tekan  untuk mengaktifkan Kapitalisasi Kalimat. Jika diaktifkan, ✓ muncul di sebelah Diaktifkan.
 - Tekan  untuk menonaktifkan Kapitalisasi Kalimat. Jika dinonaktifkan, ✓ hilang dari sebelah Diaktifkan.
-

Melihat Kata Khusus

Anda dapat menambahkan kata khusus sendiri ke kamus internal di radio. Radio Anda menyimpan daftar yang berisi kata ini.

1 Tekan  untuk mengakses menu.

2 Tekan  atau  ke Utilitas. Tekan  untuk memilih.

3 Tekan  atau  ke Pengaturan Radio. Tekan  untuk memilih.

4 Tekan  atau  ke Entri Teks. Tekan  untuk memilih.

5 Tekan  atau  ke Kata-Kata Saya. Tekan  untuk memilih.

6 Tekan  atau  ke Daftar Kata. Tekan  untuk memilih.

Layar akan menampilkan daftar kata khusus tersebut.

Mengedit Kata Khusus

Anda bisa mengedit kata khusus yang disimpan di radio Anda.



1 Tekan  untuk mengakses menu.

2 Tekan  atau  ke Utilitas. Tekan  untuk memilih.

3 Tekan  atau  ke Pengaturan Radio. Tekan  untuk memilih.

4 Tekan  atau  ke Entri Teks. Tekan  untuk memilih.

5 Tekan  atau  ke Kata-Kata Saya. Tekan  untuk memilih.



6 Tekan  atau  ke Daftar Kata. Tekan  untuk memilih.

Layar akan menampilkan daftar kata khusus tersebut.

7 Tekan  atau  ke kata yang diinginkan. Tekan  untuk memilih.

8 Tekan  atau  ke Edit. Tekan  untuk memilih.

9 Gunakan keypad untuk mengedit kata khusus Anda.

- Tekan  untuk bergerak satu spasi ke kiri.
- Tekan tombol  untuk bergerak satu spasi ke kanan.
- Tekan  untuk menghapus karakter yang tidak diinginkan.

- Tekan lama  untuk mengganti metode entri teks.
-

10 Tekan  setelah kata khusus Anda selesai.

Layar menampilkan pemberitahuan mini transisional, yang mengonfirmasikan bahwa pembaruan status Anda sedang disimpan.

- Jika kata khusus disimpan, sebuah nada akan berbunyi dan layar menampilkan pemberitahuan mini positif.
- Jika kata khusus tidak disimpan, sebuah nada rendah akan berbunyi dan layar menampilkan pemberitahuan mini negatif.

Menambahkan Kata Khusus

Anda dapat menambahkan kata khusus ke kamus internal radio.

1 Tekan  untuk mengakses menu.

2 Tekan  atau  ke **Utilitas**. Tekan  untuk memilih.

3 Tekan  atau  ke **Pengaturan Radio**. Tekan  untuk memilih.



4 Tekan  atau  ke **Entri Teks**. Tekan  untuk memilih.



5 Tekan  atau  ke **Kata-Kata Saya**. Tekan  untuk memilih.

6 Tekan  atau  ke **Tambah Kata Baru**. Tekan  untuk memilih.

Layar akan menampilkan daftar kata khusus tersebut.

7 Gunakan keypad untuk mengedit kata khusus Anda.

- Tekan  untuk bergerak satu spasi ke kiri.
- Tekan tombol  untuk bergerak satu spasi ke kanan.

- Tekan  untuk menghapus karakter yang tidak diinginkan.
- Tekan lama  untuk mengganti metode entri teks.

8 Tekan  setelah kata khusus Anda selesai.

Layar menampilkan pemberitahuan mini transisional, yang mengonfirmasi bahwa pembaruan status Anda sedang disimpan.



- Jika kata khusus disimpan, sebuah nada akan berbunyi dan layar menampilkan pemberitahuan mini positif.
- Jika kata khusus tidak disimpan, sebuah nada rendah akan berbunyi dan layar menampilkan pemberitahuan mini negatif.

Menghapus Kata Khusus



Ikuti prosedur untuk menghapus kata khusus yang disimpan di radio Anda.

1 Tekan  untuk mengakses menu.

2 Tekan  atau  ke *Utilitas*. Tekan  untuk memilih.

3 Tekan  atau  ke *Pengaturan Radio*. Tekan  untuk memilih.





4 Tekan  atau  ke *Entri Teks*. Tekan  untuk memilih.

5 Tekan  atau  ke *Kata-Kata Saya*. Tekan  untuk memilih.

6 Tekan  atau  ke kata yang diinginkan. Tekan  untuk memilih.

7 Tekan  atau  ke *Hapus*. Tekan  untuk memilih.



8 Lakukan salah satu hal berikut.



- Pada Hapus Entri?, tekan  untuk memilih Ya. Layar menampilkan Entri Dihapus.
 - Tekan  atau  ke Tidak. Tekan  untuk kembali ke layar sebelumnya.
-



Menghapus Semua Kata Khusus



Ikuti prosedur untuk menghapus semua kata khusus dari kamus internal di radio Anda.

- 1 Tekan  untuk mengakses menu.

 - 2 Tekan  atau  ke Utilitas. Tekan  untuk memilih.





 - 3 Tekan  atau  ke Pengaturan Radio. Tekan  untuk memilih.

 - 4 Tekan  atau  ke Entri Teks. Tekan  untuk memilih.
-

- 5 Tekan  atau  ke Kata-Kata Saya. Tekan  untuk memilih.
-

- 6 Tekan  atau  ke Hapus Semua. Tekan  untuk memilih.
-

- 7 Lakukan salah satu langkah berikut:

- Pada Hapus Entri?, tekan  untuk memilih Ya. Layar menampilkan Semua Entri Dihapus.
 - Tekan  atau  ke Tidak untuk kembali ke layar sebelumnya. Tekan  untuk memilih.
-

Tiket Tugas

Fitur ini memungkinkan radio Anda menerima pesan dari dispatcher berisi daftar tugas yang harus dijalankan.

**PEMBERITAHUAN:**

Fitur ini dapat disesuaikan melalui CPS sesuai dengan persyaratan pengguna. Tanyakan kepada penyalur atau administrator sistem Anda untuk informasi lebih lanjut.

Ada dua folder yang berisi Tiket Tugas yang berbeda:

Folder Tugas Saya

Tiket Tugas yang dapat dipersonalisasi ditugaskan ke ID pengguna yang Anda masuki.

Folder Tugas yang Dibagikan

Tiket Tugas yang dibagikan ditetapkan ke grup atau individu.

Anda dapat merespons Tiket Tugas untuk menyortirnya ke dalam Folder Tiket Tugas. Secara default, foldernya adalah **Semua**, **Baru**, **Dimulai**, dan **Selesai**. Untuk 10 folder tambahan, hubungi dealer atau administrator sistem Anda.

**PEMBERITAHUAN:**

Tiket Tugas akan disimpan meskipun radio dimatikan dan dihidupkan kembali.

Semua Tiket Tugas berada di folder **Semua**. Tergantung bagaimana radio Anda diprogram, Tiket Tugas disortir berdasarkan tingkat prioritas yang diikuti dengan waktu penerimaan. Tiket Tugas Baru, yaitu Tiket Tugas dengan status perubahan terbaru, dan Tiket Tugas dengan prioritas

tertinggi dicantumkan terlebih dulu. Setelah mencapai jumlah maksimum, Tiket Tugas berikutnya akan secara otomatis menggantikan Tiket Tugas terakhir yang ada di radio. Radio Anda mendukung maksimum 100 atau 500 Tiket Tugas, tergantung pada model radio. Tanyakan kepada penyalur atau administrator sistem Anda untuk informasi lebih lanjut. Radio Anda secara otomatis mendeteksi dan membuang Tiket Tugas duplikat dengan ID Tiket Tugas yang sama.

Tergantung pada pentingnya Tiket Tugas, dispatcher menambahkan Tingkat Prioritas ke dalamnya. Ada tiga tingkat prioritas: Prioritas 1, Prioritas 2, dan Prioritas 3. Prioritas 1 memiliki prioritas tertinggi dan Prioritas 3 adalah yang terendah. Selain itu ada Tiket Tugas tanpa prioritas.



Radio Anda memperbarui saat dispatcher melakukan perubahan berikut ini:



- Memodifikasi konten Tiket Tugas.
- Menambahkan atau mengedit Tingkat Prioritas Tiket Tugas.
- Memindahkan Tiket Tugas dari folder ke folder.
- Membatalkan Tiket Tugas.



Mengakses Folder Tiket Tugas

Ikuti prosedur untuk mengakses folder Tiket Tugas.

- 1 Lakukan salah satu langkah berikut:
 - Tekan tombol **Tiket Tugas** terprogram. Lanjutkan ke [langkah 3](#).
 - Tekan  untuk mengakses menu.

- 2 Tekan  atau  ke Tiket Tugas. Tekan  untuk memilih.



- 3 Tekan  atau  ke folder yang diinginkan. Tekan  untuk memilih.

- 4 Tekan  atau  ke Tiket Tugas yang diinginkan. Tekan  untuk memilih.

Masuk atau Keluar dari Server Jauh

Fitur ini memungkinkan Anda masuk dan keluar dari server jauh menggunakan ID pengguna.

- 1 Tekan  untuk mengakses menu.

- 2 Tekan  atau  ke Masuk. Tekan  untuk memilih.
 Jika Anda sudah masuk, menu menampilkan Keluar.
 Layar menampilkan pemberitahuan mini transisional, yang menunjukkan permintaan sedang diproses.







- 3 Tunggu respons.
 Jika berhasil:
 - Nada indikator positif akan berbunyi.
 - Layar menampilkan pemberitahuan mini positif.
 Jika tidak berhasil:
 - Nada indikator negatif akan berbunyi.

- Layar menampilkan pemberitahuan mini negatif.

Membuat Tiket Tugas















Radio mempunyai kemampuan untuk membuat Tiket Tugas berdasarkan template Tiket Tugas dan mengirim tugas yang harus dilakukan.

Perangkat lunak pemrograman CPS diperlukan untuk mengonfigurasi template Tiket Tugas.

- 1 Tekan  untuk mengakses menu.
- 2 Tekan  atau  ke Tiket Tugas. Tekan  untuk memilih.
- 3 Tekan  atau  ke Buat Tiket. Tekan  untuk memilih.

Merespons Tiket Tugas

Ikuti prosedur untuk merespons tiket tugas di radio Anda.

- 1 Tekan  untuk mengakses menu.
- 2 Tekan  atau  ke Tiket Tugas. Tekan  untuk memilih.
- 3 Tekan  atau  ke folder yang diinginkan. Tekan  untuk memilih.
- 4 Tekan  atau  ke tiket tugas yang diinginkan. Tekan  untuk memilih.
- 5 Tekan  sekali lagi untuk mengakses submenu. Anda dapat juga menekan tombol angka yang terkait (1-9) untuk **Balas Cepat**.
- 6 Tekan  atau  ke tiket tugas yang diinginkan. Tekan  untuk memilih. Layar menampilkan pemberitahuan mini transisional, yang menunjukkan permintaan sedang diproses.

7 Tunggu respons.

Jika berhasil:

- Nada indikator positif akan berbunyi.
- Layar menampilkan pemberitahuan mini positif.



Jika tidak berhasil:

- Nada indikator negatif akan berbunyi.
- Layar menampilkan pemberitahuan mini negatif.

Mengirim Tiket Tugas Menggunakan Satu Template Tiket Tugas

Jika radio Anda dikonfigurasi dengan satu template Tiket Tugas, lakukan tindakan berikut untuk mengirim Tiket Tugas.

1 Gunakan keypad untuk mengetik nomor ruang yang diinginkan. Tekan  untuk memilih.

2 Tekan  atau  ke Status Ruang. Tekan  untuk memilih.

3 Tekan  atau  ke opsi yang diinginkan.

Tekan  untuk memilih.

4 Tekan  atau  ke Kirim. Tekan  untuk memilih.

Layar menampilkan pemberitahuan mini transisional, yang menunjukkan permintaan sedang diproses.

5 Tunggu respons.

Jika berhasil:



- Nada indikator positif akan berbunyi.
- Layar menampilkan pemberitahuan mini positif.

Jika tidak berhasil:

- Nada indikator negatif akan berbunyi.
- Layar menampilkan pemberitahuan mini negatif.

Mengirim Tiket Tugas Menggunakan Lebih Dari Satu Template Tiket Tugas

Jika radio Anda dikonfigurasi dengan lebih dari satu template Tiket Tugas, lakukan tindakan berikut untuk mengirim Tiket Tugas.

- 1 Tekan  atau  ke opsi yang diinginkan.
Tekan  untuk memilih.

- 2 Tekan  atau  ke Kirim. Tekan  untuk memilih.

Layar menampilkan pemberitahuan mini transisional, yang menunjukkan permintaan sedang diproses.

- 3 Tunggu respons.

Jika berhasil:

- Nada indikator positif akan berbunyi.
- Layar menampilkan pemberitahuan mini positif.

Jika tidak berhasil:

- Nada indikator negatif akan berbunyi.

- Layar menampilkan pemberitahuan mini negatif.

Menghapus Tiket Tugas



Ikuti prosedur untuk menghapus tiket tugas di radio Anda.

- 1 Lakukan salah satu langkah berikut:
 - Tekan tombol **Tiket Tugas** terprogram. Lanjutkan ke [langkah 4](#)
 - Tekan  untuk mengakses menu.

- 2 Tekan  atau  ke Tiket Tugas. Tekan  untuk memilih.

- 3 Tekan  atau  ke folder yang diinginkan.
Tekan  untuk memilih.

- 4 Tekan  atau  ke Semua folder. Tekan  untuk memilih.

5 Tekan  atau  ke Tiket Tugas yang diinginkan. Tekan  untuk memilih.

6 Tekan  lagi sewaktu menampilkan Tiket Tugas.

7 Tekan  atau  ke Hapus. Tekan  untuk memilih.

Layar menampilkan pemberitahuan mini transisional, yang menunjukkan permintaan sedang diproses.

8 Tunggu respons.

Jika berhasil:

- Nada indikator positif akan berbunyi.
- Layar menampilkan pemberitahuan mini positif.

Jika tidak berhasil:



- Nada indikator negatif akan berbunyi.
 - Layar menampilkan pemberitahuan mini negatif.
-



Menghapus Semua Tiket Tugas

Ikuti prosedur untuk menghapus semua tiket tugas di radio Anda.



1 Lakukan salah satu langkah berikut:

- Tekan tombol **Tiket Tugas** terprogram. Lanjutkan ke [langkah 3](#).
 - Tekan  untuk mengakses menu.
-







2 Tekan  atau  ke Tiket Tugas. Tekan  untuk memilih.

3 Tekan  atau  ke folder yang diinginkan. Tekan  untuk memilih.

4 Tekan  atau  ke Semua folder. Tekan  untuk memilih.

5 Tekan  atau  ke Hapus Semua. Tekan  untuk memilih.

6 Lakukan salah satu langkah berikut:

- Tekan  atau  ke Ya. Tekan  untuk memilih.
Layar menampilkan pemberitahuan mini positif.
- Tekan  atau  ke Tidak. Tekan  untuk memilih.
Radio kembali ke layar sebelumnya.

Privasi

Fitur ini membantu mencegah pengguna yang tidak sah menguping di saluran menggunakan solusi pengacakan berbasis perangkat lunak. Transmisi pengiriman sinyal dan identifikasi pengguna tidak diacak.

Privasi pada radio Anda harus diaktifkan pada saluran tersebut untuk mengirim transmisi dengan privasi diaktifkan, meskipun ini bukan persyaratan yang perlu untuk menerima transmisi. Ketika berada pada saluran dengan privasi diaktifkan, radio masih bisa menerima transmisi yang jernih atau tanpa diacak.

Radio Anda hanya mendukung Privasi yang Disempurnakan. Untuk menguraikan transmisi data atau panggilan dengan privasi diaktifkan, radio Anda harus

diprogram agar mempunyai Nilai Kunci dan ID Kunci untuk Privasi yang Disempurnakan yang sama dengan radio yang mengirim transmisi.

Jika radio Anda menerima panggilan diacak yang mempunyai Nilai Kunci dan ID Kunci yang berbeda, Anda tidak akan mendengar apa pun untuk Privasi yang Disempurnakan.

Pada saluran yang mengaktifkan privasi, radio dapat menerima panggilan jernih atau tanpa diacak, tergantung pemrograman radio Anda. Selain itu, radio mungkin memutar nada peringatan atau tidak, tergantung pemrogramannya.



PEMBERITAHUAN:

Fitur ini tidak tersedia dalam saluran Citizens Band yang berada dalam frekuensi yang sama.

LED hijau akan menyala saat radio melakukan transmisi dan akan berkedip dengan cepat saat radio menerima transmisi yang berlangsung dengan privasi diaktifkan.







PEMBERITAHUAN:



Model radio tertentu belum tentu mempunyai fitur Privasi ini, atau mempunyai konfigurasi berbeda. Tanyakan kepada penyalur atau administrator sistem Anda untuk informasi lebih lanjut.



Mengaktifkan atau Menonaktifkan Privasi

Ikuti prosedur untuk mengaktifkan atau menonaktifkan privasi di radio Anda.







- 1 Lakukan salah satu langkah berikut:
 - Tekan tombol terprogram **Privasi**. Lompati langkah-langkah di bawah ini.
 - Tekan  untuk mengakses menu.

- 2 Tekan  atau  ke **Utilitas**. Tekan  untuk memilih.

- 3 Tekan  atau  ke **Pengaturan Radio**. Tekan  untuk memilih.

- 4 Tekan  atau  ke **Privasi**. Tekan  untuk memilih.

- 5 Lakukan salah satu langkah berikut:

- Tekan  atau  ke **Aktif**. Tekan  untuk memilih. Layar menampilkan ✓ di sebelah **Aktif**.
- Tekan  atau  ke **Nonaktif**. Tekan  untuk memilih. Layar menampilkan ✓ di sebelah **Nonaktif**.

Larangan Tanggapan

Fitur ini mencegah radio menanggapi transmisi masuk.



PEMBERITAHUAN:

Fitur ini dapat dibeli. Tanyakan kepada dealer atau administrator sistem Anda untuk mengetahui bagaimana radio Anda diprogram.

Jika aktif, radio tidak menghasilkan transmisi keluar untuk menanggapi transmisi masuk, seperti Pemeriksaan Radio, Peringatan Panggilan, Penonaktifan Radio, Monitor Jarak Jauh, Layanan Pendaftaran Otomatis (ARS), Penanggapan Pesan Pribadi, dan Pengiriman laporan lokasi GNSS. Saat fitur ini aktif, radio tidak dapat menerima Panggilan Pribadi yang Dikonfirmasi. Namun, radio dapat mengirim transmisi secara manual.

Menonaktifkan atau Menonaktifkan Larangan Tanggapan

Ikuti prosedur untuk mengaktifkan atau menonaktifkan Larangan Tanggapan di radio.

Tekan tombol terprogram **Larangan Tanggapan**.

Jika berhasil:

- Nada indikator positif akan berbunyi.
- Layar menampilkan pemberitahuan mini positif.

Jika tidak berhasil:

- Nada indikator negatif akan berbunyi.
- Layar menampilkan pemberitahuan mini negatif.

Stun/Revive

Fitur ini memungkinkan Anda mengaktifkan atau menonaktifkan radio di dalam sistem. Misalnya, penyalur atau administrator sistem ingin menonaktifkan radio yang dicuri agar pengguna yang tidak sah tidak dapat menggunakannya, dan mengaktifkan radio tersebut ketika sudah ditemukan.

Radio dapat dinonaktifkan (stun) atau diaktifkan (revive) melalui konsol atau perintah dari radio lain.

Setelah dinonaktifkan, radio akan mengeluarkan nada indikator negatif dan layar utamanya menampilkan Saluran Ditolak.

Ketika dimatikan sementara, radio tidak dapat meminta atau menerima layanan yang dimulai pengguna pada sistem yang melakukan prosedur Mati Sementara. Namun, radio dapat beralih ke sistem lain. Radio terus mengirim laporan lokasi GNSS dan dapat dipantau dari jauh ketika dimatikan sementara.





PEMBERITAHUAN:

Penyalur atau administrator sistem dapat menonaktifkan radio secara permanen. Lihat [Radio Kill di halaman 190](#) untuk informasi selengkapnya.

Mengaktifkan Radio

Ikuti prosedur untuk menonaktifkan radio.

- 1 Tekan tombol **Penonaktifan Radio** terprogram.
-

- 2 Tekan  atau  ke alias atau ID yang diinginkan. Tekan  untuk memilih. Layar menampilkan pemberitahuan mini transisional, yang menunjukkan permintaan sedang diproses. LED akan berkedip hijau.
-

- 3 Tunggu respons.

Jika berhasil:

- Nada indikator positif akan berbunyi.
- Layar menampilkan pemberitahuan mini positif.

Jika tidak berhasil:



- Nada indikator negatif akan berbunyi.
 - Layar menampilkan pemberitahuan mini negatif.
-



Menonaktifkan Sementara Radio Menggunakan Daftar Kontak

Ikuti prosedur untuk menonaktifkan radio menggunakan Daftar Kontak.

- 1 Tekan  untuk mengakses menu.
-

- 2 Tekan  atau  ke Kontak. Tekan  untuk memilih.
-

- 3 Tekan  atau  ke alias atau ID yang diinginkan. Tekan  untuk memilih.
-

- 4 Tekan  atau  ke Penonaktifan Radio. Tekan  untuk memilih.

Layar menampilkan pemberitahuan mini transisional, yang menunjukkan permintaan sedang diproses. LED akan berkedip hijau.

- 5 Tunggu respons.

Jika berhasil:

- Nada indikator positif akan berbunyi.
- Layar menampilkan pemberitahuan mini positif.











Jika tidak berhasil:

- Nada indikator negatif akan berbunyi.

- Layar menampilkan pemberitahuan mini negatif.

Menonaktifkan Radio Menggunakan Panggilan Manual

Ikuti prosedur untuk menonaktifkan radio menggunakan panggilan manual.

- 1 Tekan  untuk mengakses menu.
- 2 Tekan  atau  ke Kontak. Tekan  untuk memilih.
- 3 Tekan  atau  ke Panggilan Manual. Tekan  untuk memilih.
- 4 Tekan  atau  ke Nomor Radio. Tekan  untuk memilih.
Baris teks pertama menampilkan Nomor Radio:.

- 5 Masukkan ID subscriber, lalu tekan  untuk melanjutkan.

- 6 Tekan  atau  ke Penonaktifan Radio. Tekan  untuk memilih.

Layar menampilkan pemberitahuan mini transisional, yang menunjukkan permintaan sedang diproses. LED akan berkedip hijau.

- 7 Tunggu respons.

Jika berhasil:

- Nada indikator positif akan berbunyi.
- Layar menampilkan pemberitahuan mini positif.

Jika tidak berhasil:

- Nada indikator negatif akan berbunyi.
- Layar menampilkan pemberitahuan mini negatif.

Mengaktifkan Radio

Ikuti prosedur untuk mengaktifkan radio.

1 Tekan tombol **Pengaktifan Radio** yang terprogram.

2 Tekan  atau  ke alias atau ID yang diinginkan. Tekan  untuk memilih.

Layar menampilkan Pengaktifan Radio dan alias atau ID subscriber. LED hijau akan menyala.

3 Tunggu respons.

Jika berhasil:

- Nada indikator positif akan berbunyi.
- Layar menampilkan pemberitahuan mini positif.

Jika tidak berhasil:

- Nada indikator negatif akan berbunyi.
 - Layar menampilkan pemberitahuan mini negatif.
-

Mengaktifkan Radio Menggunakan Daftar Kontak

Ikuti prosedur untuk mengaktifkan radio menggunakan Daftar Kontak.

1 Tekan  untuk mengakses menu.

2 Tekan  atau  ke Kontak. Tekan  untuk memilih.

3 Tekan  atau  ke alias atau ID yang diinginkan. Tekan  untuk memilih.

4 Tekan  atau  ke Pengaktifan Radio.

Tekan  untuk memilih.

LED akan berkedip hijau.

Layar menampilkan Pengaktifan Radio dan alias atau ID subscriber. LED hijau akan menyala.

5 Tunggu respons.

Jika berhasil:







- Nada akan berbunyi.
- Layar menampilkan Pengaktifan Radio Berhasil.



Jika tidak berhasil:

- Nada akan berbunyi.
- Layar menampilkan Pengaktifan Radio Gagal.



Mengaktifkan Radio Menggunakan Panggilan Manual

Ikuti prosedur untuk mengaktifkan radio menggunakan Panggilan Manual.

- 1 Tekan  untuk mengakses menu.
- 2 Tekan  atau  ke Kontak. Tekan  untuk memilih.
- 3 Tekan  atau  ke Panggilan Manual. Tekan  untuk memilih.

- 4 Tekan  atau  ke Panggilan Pribadi. Tekan  untuk memilih. Baris teks pertama menampilkan Nomor Radio:.

- 5 Masukkan ID subscriber, lalu tekan  untuk melanjutkan.

- 6 Tekan  atau  ke Pengaktifan Radio. Tekan  untuk memilih. LED akan berkedip hijau. Layar menampilkan Pengaktifan Radio dan alias atau ID subscriber. LED hijau akan menyala.

- 7 Tunggu respons. Jika berhasil:
 - Nada akan berbunyi.
 - Layar menampilkan Pengaktifan Radio Berhasil.
 Jika tidak berhasil:

- Nada akan berbunyi.
- Layar menampilkan Pengaktifan Radio Gagal.

Radio Kill

Fitur ini meningkatkan keamanan yang melarang akses radio tanpa otorisasi.

Radio Kill menyebabkan radio dirender hingga tidak dapat dioperasikan. Misalnya, penyalur atau administrator sistem ingin menonaktifkan radio yang dicuri atau hilang untuk mencegah penggunaan tanpa otorisasi.

Saat dihidupkan, radio nonaktif menampilkan `Radio Killed` sesaat di layar yang menunjukkan status nonaktif.



PEMBERITAHUAN:

Radio nonaktif hanya dapat dipulihkan di toko layanan Motorola Solutions. Tanyakan kepada penyalur atau administrator sistem Anda untuk informasi lebih lanjut.

Pekerja Terpisah

Fitur ini memicu keadaan darurat yang akan diangkat jika tidak ada aktivitas pengguna, seperti penekanan tombol

radio atau aktivasi pemilihan saluran, selama waktu yang ditentukan sebelumnya.

Setelah tidak ada aktivitas pengguna selama durasi terprogram, radio sebelumnya mengingatkan pengguna melalui indikator audio setelah pengatur waktu nonaktif habis.

Jika tetap tidak ada respons oleh pengguna sebelum pengatur waktu pengingat yang ditetapkan sebelumnya habis, radio menginisiasi kondisi darurat sebagaimana diprogram oleh penyalur atau administrator sistem.

Lihat [Pengoperasian Darurat di halaman 139](#) untuk informasi selengkapnya.



PEMBERITAHUAN:

Tanyakan kepada penyalur atau administrator sistem Anda untuk informasi lebih lanjut.

Fitur Kunci Kata Sandi

Fitur ini memungkinkan Anda membatasi akses ke radio dengan meminta kata sandi saat perangkat dinyalakan.

Anda dapat menggunakan mikrofon keypad atau tombol **Gulir Atas/Bawah** untuk memasukkan kata sandi.

Mengakses Radio Menggunakan Kata Sandi



Ikuti prosedur untuk mengakses radio menggunakan kata sandi.

- 1 Masukkan kata sandi empat digit yang Anda gunakan saat ini.



PEMBERITAHUAN:

Penggunaan sakelar kaki **Darurat** akan membatalkan masukan kata sandi untuk mengakses radio.

- Gunakan mikrofon keypad.
- Tekan  atau  untuk mengedit nilai numerik setiap digit, lalu tekan  untuk memasukkan dan berpindah ke digit selanjutnya.

- 2 Tekan  untuk memasukkan kata sandi.

Jika berhasil, radio akan menyala.

Jika tidak berhasil:

- Setelah upaya pertama dan kedua, layar menampilkan Kata Sandi Salah. Ulangi [langkah 1](#).
- Setelah tiga kali kesalahan kata sandi, layar menampilkan Kata Sandi Salah lalu Radio Terkunci. Nada akan berbunyi. LED kuning berkedip ganda. Radio masuk ke status terkunci selama 15 menit.



PEMBERITAHUAN:

Dalam keadaan terkunci, radio merespons masukan dari **Kenop Aktif/Nonaktif/Kontrol Volume** dan tombol **Lampu Latar** terprogram saja.

Membuka Kunci Radio dalam Status Terkunci

Radio Anda tidak dapat menerima panggilan dalam status terkunci. Ikuti prosedur untuk membuka kunci radio dalam status terkunci.

Lakukan salah satu langkah berikut:

- Jika radio dihidupkan, tunggu hingga 15 menit, lalu ulangi langkah-langkah tersebut dalam [Mengakses](#)

[Radio Menggunakan Kata Sandi](#) di halaman 191 untuk mengakses radio.

- Jika radio dimatikan, nyalakan radio. Radio memulai ulang pencatat waktu 15 menit untuk status terkunci. Nada akan berbunyi. LED kuning berkedip ganda. Layar menampilkan Radio Terkunci.

Tunggu selama 15 menit, lalu ulangi langkah-langkah tersebut dalam [Mengakses Radio Menggunakan Kata Sandi](#) di halaman 191 untuk mengakses radio.

Mengaktifkan atau Menonaktifkan Kunci Kata Sandi

Ikuti prosedur untuk mengaktifkan atau menonaktifkan kunci kata sandi di radio Anda.



1 Tekan  untuk mengakses menu.

2 Tekan  atau  ke Utilitas. Tekan  untuk memilih.

3 Tekan  atau  ke Pengaturan Radio. Tekan  untuk memilih.









4 Tekan  atau  ke Kunci Kata Sandi. Tekan  untuk memilih.

5 Masukkan kata sandi empat digit yang Anda gunakan saat ini.

- Gunakan mikrofon keypad.
- Tekan  atau  untuk mengedit nilai numerik setiap digit, lalu tekan  untuk memasukkan dan berpindah ke digit selanjutnya. Nada indikator positif akan terdengar untuk setiap digit yang ditekan.

6 Tekan  untuk memasukkan kata sandi. Jika kata sandi salah, layar menampilkan **Kata Sandi Salah** dan otomatis kembali ke menu sebelumnya.



7 Lakukan salah satu langkah berikut:



- Tekan  atau  ke Aktifkan. Tekan  untuk memilih. Layar akan menampilkan  di sebelah Nyala.
 - Tekan  atau  ke Nonaktifkan. Tekan  untuk memilih. Layar akan menampilkan  di sebelah Mati.
-

Mengganti Kata Sandi

Ikuti prosedur untuk mengganti kata sandi di radio Anda.

- 1 Tekan  untuk mengakses menu.

- 2 Tekan  atau  ke Utilitas. Tekan  untuk memilih.

- 3 Tekan  atau  ke Pengaturan Radio. Tekan  untuk memilih.

- 4 Tekan  atau  ke Kunci Kata Sandi. Tekan  untuk memilih.

- 5 Masukkan kata sandi empat digit saat ini, lalu tekan  untuk melanjutkan. Jika kata sandi salah, layar menampilkan Kata Sandi Salah, dan otomatis kembali ke menu sebelumnya.

- 6 Tekan  atau  ke Ubah Kata Sandi. Tekan  untuk memilih.

- 7 Masukkan kata sandi empat digit baru, lalu tekan  untuk melanjutkan.

- 8 Masukkan kembali kata sandi empat digit baru, lalu tekan  untuk melanjutkan. Jika berhasil, layar menampilkan Kata Sandi Diubah. Jika tidak berhasil, layar menampilkan Kata Sandi Tidak Cocok.

Layar kembali ke menu sebelumnya secara otomatis.

Daftar Notifikasi

Radio Anda dilengkapi daftar Pemberitahuan yang akan mengumpulkan semua aktivitas yang belum dibaca pada saluran, misalnya pesan teks yang belum dibaca, pesan telemetri, panggilan tidak terjawab, dan peringatan panggilan.









Layar menampilkan ikon **Notifikasi** ketika terdapat satu atau lebih kejadian dalam daftar Notifikasi.

Daftar ini mendukung maksimal 40 kejadian tak terbaca. Jika daftar penuh, kejadian selanjutnya menggantikan kejadian paling lama secara otomatis. Setelah dibaca, kejadian dihapus dari daftar Notifikasi.

Untuk aktivitas pesan teks, panggilan tidak terjawab, peringatan panggilan, jumlah maksimum pemberitahuan adalah 30 pesan teks dan 10 panggilan tidak terjawab atau peringatan panggilan. Jumlah maksimum ini akan tergantung pada kemampuan daftar fitur (tiket tugas, pesan teks, atau panggilan tidak terjawab atau peringatan panggilan).

Mengakses Daftar Notifikasi

Ikuti prosedur untuk mengakses daftar Notifikasi di radio Anda.

- 1 Tekan  untuk mengakses menu.
- 2 Tekan  atau  ke Notifikasi. Tekan  untuk memilih.
- 3 Tekan  atau  ke kejadian yang diperlukan. Tekan  untuk memilih.
Tekan lama  untuk kembali ke layar Awal.

Pemrograman Melalui Udara

Dealer dapat memperbarui radio Anda dari jauh menggunakan Over-the-Air Programming (OTAP) tanpa koneksi fisik. Selain itu, beberapa pengaturan juga dapat dikonfigurasi menggunakan OTAP.

Ketika radio melakukan OTAP, LED hijau berkedip.

Ketika radio menerima data volume tinggi:

- Layar menampilkan ikon **Data Volume Tinggi**.
- Saluran menjadi sibuk.
- Nada negatif akan berbunyi jika Anda menekan tombol **PTT**.

Setelah OTAP selesai, tergantung pada konfigurasi:

- Nada akan berbunyi. Layar menampilkan **Memulai Ulang Pembaruan**. Radio memulai ulang dengan mati dan menyala lagi.
- Anda dapat memilih **Mulai Ulang Sekarang** atau **Tunda**. Jika Anda memilih **Tunda**, radio kembali ke layar sebelumnya. Layar menampilkan ikon **Pencatat Waktu Penundaan OTAP** sampai mulai ulang otomatis terjadi.

Jika radio menyala setelah mulai ulang otomatis:

- Jika berhasil, layar menampilkan **Pembaruan Perangkat Lunak Selesai**.
- Jika tidak berhasil, layar menampilkan **Pembaruan Perangkat Lunak Gagal**.

Lihat [Memeriksa Informasi Pembaruan Perangkat Lunak di halaman 228](#) untuk perangkat lunak versi terbaru.

Memilih Mode Koneksi Periferal Pihak Ketiga



Ikuti prosedur untuk memilih salah satu mode koneksi periferal pihak ketiga berikut:



- Motorola Solutions
- PC dan Audio
- Aksesori Data
- Telemetry
- Generik

1 Tekan  untuk mengakses menu.

2 Tekan  atau  ke **Utilitas**. Tekan  untuk memilih.

3 Tekan  atau  ke **Pengaturan Radio**. Tekan  untuk memilih.

4 Tekan  atau  ke Jenis Kabel. Tekan  untuk memilih.

5 Tekan  atau  ke mode koneksi yang diinginkan. Tekan  untuk memilih. Layar akan menampilkan mode koneksi yang dipilih. Layar kembali ke menu sebelumnya.



Indikator Kekuatan Sinyal Penerimaan

Dengan fitur ini, Anda dapat melihat nilai Indikator Kekuatan Sinyal Diterima (RSSI).

Layar menampilkan ikon **RSSI** di sudut kanan atas. Lihat [Ikon Layar](#) untuk informasi selengkapnya tentang ikon **RSSI**.

Melihat Nilai RSSI

Pasang Mikrofon Keypad Navigasi 4 Arah (nomor komponen Motorola Solutions RMN5127_) ke radio Anda.

Pada layar awal, menggunakan Mikrofon Keypad Navigasi 4 Arah, tekan  tiga kali dan segera tekan  tiga kali.

Layar menampilkan nilai RSSI yang sekarang.

Untuk kembali ke layar awal, tekan dan tahan .

Konfigurasi Panel Depan

Anda dapat mengatur parameter fitur tertentu pada Konfigurasi Panel Depan (FPC) untuk meningkatkan penggunaan radio.



Masuk ke Mode Konfigurasi Panel Depan

Ikuti prosedur untuk masuk ke mode pemrograman panel depan di radio Anda.

Untuk kembali ke layar Awal, tekan lama  kapan saja.





1 Tekan  untuk mengakses menu.

2 Tekan  atau  ke **Utilitas**. Tekan  untuk memilih.

3 Tekan  atau  ke **Program Radio**. Tekan  untuk memilih.

Mengedit Parameter Mode FPP

Gunakan tombol berikut ini sesuai kebutuhan ketika menelusuri parameter fitur.

-   , – Gulir di antara opsi, naikkan/turunkan nilai, atau telusuri secara vertikal.
-  – Pilih opsi atau masuk ke sub-menu.
-  – Tekan sebentar untuk kembali ke menu sebelumnya atau keluar dari layar pilihan. Tekan lama untuk kembali ke layar Awal.

Pengoperasian Wi-Fi

Fitur ini memungkinkan Anda mengatur dan terhubung ke jaringan Wi-Fi. Wi-Fi mendukung pembaruan untuk

firmware, codeplug, dan sumber daya radio seperti paket bahasa dan pengumuman suara.



PEMBERITAHUAN:

Fitur ini hanya berlaku untuk XiR M8668i/CM7668i saja.

Wi-Fi® adalah merek dagang terdaftar dari Wi-Fi Alliance®.

Radio Anda mendukung WEP/WPA/WPA2-Personal dan jaringan Wi-Fi WPA/WPA2-Enterprise.

Jaringan Wi-Fi WEP/WPA/WPA2-Personal

Menggunakan otentikasi berbasis kunci (kata sandi) yang dibagikan sebelumnya.

Kunci yang dibagikan sebelumnya bisa dimasukkan menggunakan menu atau CPS/RM.

Jaringan Wi-Fi WPA/WPA2-Enterprise

Menggunakan otentikasi berbasis sertifikat.

Radio Anda harus dikonfigurasi terlebih dahulu dengan sertifikat.



PEMBERITAHUAN:

Tanyakan kepada dealer atau administrator sistem Anda untuk terhubung ke jaringan Wi-Fi WPA/WPA2-Enterprise.

Tombol terprogram **Wi-Fi Aktif** atau **Nonaktif** dialokasikan oleh penyalur atau administrator sistem Anda. Tanyakan

kepada dealer atau administrator sistem Anda untuk mengetahui bagaimana radio Anda diprogram.

Pengumuman Suara untuk tombol terprogram **Wi-Fi Aktif** atau **Nonaktif** dapat disesuaikan melalui CPS sesuai dengan kebutuhan pengguna. Tanyakan kepada penyalur atau administrator sistem Anda untuk informasi lebih lanjut.











PEMBERITAHUAN:

Anda dapat mengaktifkan atau menonaktifkan Wi-Fi dari jarak jauh menggunakan radio supervisor (lihat [Mengaktifkan atau Menonaktifkan Wi-Fi Menggunakan Radio Supervisor](#)). Tanyakan kepada penyalur atau administrator sistem Anda untuk informasi lebih lanjut.

Mengaktifkan atau Menonaktifkan Wi-Fi

Ikuti prosedur untuk mengaktifkan dan menonaktifkan Wi-Fi.

- 1 Tekan tombol terprogram **Wi-Fi Aktif** atau **Nonaktif**. Pengumuman Suara berbunyi ketika Wi-Fi Diaktifkan atau Wi-Fi Dinonaktifkan.
- 2 Akses fitur ini menggunakan menu.



- a Tekan  untuk mengakses menu.
- b Tekan  atau  ke WiFi dan tekan  untuk memilih.
- c Tekan  atau  ke WiFi Aktif dan tekan  untuk memilih.
- d Tekan  untuk mengaktifkan/menonaktifkan Wi-Fi.
Jika Wi-Fi diaktifkan, layar akan menampilkan ✓ di sebelah Diaktifkan.
Jika Wi-Fi dinonaktifkan, ✓ hilang dari sebelah Diaktifkan.

Mengaktifkan atau Menonaktifkan Wi-Fi dari Jarak Jauh Menggunakan Radio Khusus (Kontrol Individu)

Ikuti prosedur untuk mengaktifkan atau menonaktifkan Wi-Fi dari jarak jauh di Kontrol Individu (Satu ke Satu).

**PEMBERITAHUAN:**

Hanya radio dengan pengaturan CPS khusus yang mendukung fungsi ini, tanyakan kepada dealer atau administrator sistem Anda untuk informasi lebih lanjut.

- 1 Lakukan salah satu langkah berikut:
 - Tekan lama tombol yang dapat diprogram. Gunakan keypad untuk memasukkan ID, dan tekan  untuk memilih. Lanjutkan ke [langkah 3](#).
 - Tekan  untuk mengakses menu.

2 Tekan  atau  ke **Kontak** dan tekan  untuk memilih.

3 Tekan  atau  ke **Kontrol WiFi** dan tekan  untuk memilih.

4 Tekan  atau  untuk memilih **Nyala** atau **Mati**.

5 Tekan  untuk memilih.

Jika berhasil, layar menampilkan pemberitahuan mini positif.

Jika gagal, layar menampilkan pemberitahuan mini negatif.

Mengaktifkan atau Menonaktifkan Wi-Fi dari Jarak Jauh Menggunakan Radio Khusus (Kontrol Grup)



Ikuti prosedur untuk mengaktifkan atau menonaktifkan Wi-Fi dari jarak jauh di Kontrol Grup (Satu ke Banyak).

**PEMBERITAHUAN:**

Hanya radio dengan pengaturan CPS khusus yang mendukung fungsi ini, tanyakan kepada dealer atau administrator sistem Anda untuk informasi lebih lanjut.

1 Tekan  untuk mengakses menu.

2 Tekan  atau  ke **Kontak** dan tekan  untuk memilih.

3 Tekan  atau  untuk memilih alias atau ID subscriber yang diinginkan.

4 Tekan  atau  ke Kontrol WiFi dan tekan  untuk memilih.

5 Tekan  atau  untuk memilih Nyala atau Mati.

6 Tekan  untuk memilih.

Jika berhasil, layar menampilkan Berhasil Dikirim.

Jika gagal, layar menampilkan pemberitahuan mini negatif.

Menghubungkan ke Titik Akses Jaringan

Ketika Wi-Fi diaktifkan, radio memindai dan menyambung ke titik akses jaringan.



PEMBERITAHUAN:



Anda juga dapat menyambung ke titik akses jaringan menggunakan menu.

Titik akses jaringan Wi-Fi WPA-Enterprise telah dikonfigurasi sebelumnya. Tanyakan kepada dealer atau administrator sistem Anda untuk mengetahui bagaimana radio Anda diprogram.

1 Tekan  untuk mengakses menu.

2 Tekan  atau  ke WiFi dan tekan  untuk memilih.



3 Tekan  atau  ke Jaringan dan tekan  untuk memilih.

4 Tekan  atau  ke titik akses jaringan dan tekan  untuk memilih.



PEMBERITAHUAN:

Untuk Wi-Fi WPA-Enterprise, jika titik akses jaringan tidak dikonfigurasi sebelumnya, opsi Hubungan tidak tersedia.

5 Tekan  atau  ke **Hubungkan** dan tekan  untuk memilih.

6 Untuk Wi-Fi WPA-Personal, masukkan kata sandi dan tekan .

7 Untuk Wi-Fi WPA-Enterprise, kata sandi dikonfigurasi dengan RM.

Jika kata sandi yang dikonfigurasi sebelumnya benar, radio Anda otomatis akan terhubung ke titik akses jaringan yang dipilih.

Jika kata sandi yang dikonfigurasi sebelumnya salah, layar menampilkan **Otentikasi Gagal**, dan otomatis kembali ke menu sebelumnya.

Jika berhasil terhubung, radio menampilkan pemberitahuan dan titik akses jaringan disimpan ke dalam daftar profil.

Jika tidak berhasil terhubung, radio menampilkan layar pemberitahuan kegagalan sesaat dan otomatis kembali ke menu sebelumnya.

Memeriksa Status Koneksi Wi-Fi

Ikuti prosedur untuk memeriksa status Koneksi Wi-Fi.

Tekan tombol terprogram **Pemintaan Status Wi-Fi** untuk mengetahui status koneksi menggunakan Pengumuman Suara. Pengumuman Suara berbunyi ketika Wi-Fi Dinonaktifkan, Wi-Fi Diaktifkan, tetapi tidak untuk Tidak Ada Koneksi atau Wi-Fi Aktif dengan Koneksi.

- Layar menampilkan **WiFi Nonaktif** saat Wi-Fi nonaktif.
- Layar menampilkan **WiFi Aktif, Tersambung** saat radio tersambung ke jaringan.
- Layar menampilkan **WiFi Aktif, Terputus** saat Wi-Fi aktif tetapi radio tidak tersambung ke jaringan.

Pengumuman Suara untuk hasil kueri status Wi-Fi dapat dikustomisasi lewat CPS sesuai dengan kebutuhan pengguna. Tanyakan kepada penyalur atau administrator sistem Anda untuk informasi lebih lanjut.









PEMBERITAHUAN:

Tombol terprogram **Kueri Status Wi-Fi** dialokasikan oleh penyalur atau administrator sistem Anda. Tanyakan kepada dealer atau administrator sistem Anda untuk mengetahui bagaimana radio Anda diprogram.



Menyegarkan Daftar Jaringan

Ikuti prosedur berikut untuk menyegarkan daftar jaringan.

- Lakukan tindakan berikut ini untuk menyegarkan daftar jaringan melalui menu.
 - a. Tekan  untuk mengakses menu.
 - b. Tekan  atau  ke WiFi dan tekan  untuk memilih.
 - c. Tekan  atau  ke Jaringan dan tekan  untuk memilih.

Ketika Anda masuk ke menu Jaringan, radio menyegarkan daftar jaringan secara otomatis.

- Jika Anda sudah berada di menu Jaringan, lakukan tindakan berikut ini untuk menyegarkan daftar jaringan.

Tekan  atau  ke Segarkan dan tekan  untuk memilih.

Radio akan menyegarkan dan menampilkan daftar jaringan terbaru.

Menambahkan Jaringan









PEMBERITAHUAN:



Tugas ini tidak bisa diterapkan ke jaringan Wi-Fi WPA-Enterprise.

Jika jaringan yang dipilih tidak terdapat dalam daftar jaringan tersedia, lakukan tindakan berikut ini untuk menambahkan jaringan.



- 1 Tekan  untuk mengakses menu.

- 2 Tekan  atau  ke WiFi dan tekan  untuk memilih.

- 3 Tekan  atau  ke Jaringan dan tekan  untuk memilih.

- 4 Tekan  atau  ke Tambah Jaringan dan tekan  untuk memilih.

- 5 Masukkan Service Set Identifier (SSID) dan tekan  .

- 6 Tekan  atau  ke Buka dan tekan  untuk memilih.

- 7 Masukkan kata sandi dan tekan  .
Radio menampilkan pemberitahuan mini positif untuk menunjukkan bahwa jaringan berhasil disimpan.

Melihat Detail Titik Akses Jaringan

Anda bisa melihat detail titik akses jaringan.

- 1 Tekan  untuk mengakses menu.

- 2 Tekan  atau  ke WiFi dan tekan  untuk memilih.

- 3 Tekan  atau  ke Jaringan dan tekan  untuk memilih.

- 4 Tekan  atau  ke titik akses jaringan dan tekan  untuk memilih.

- 5 Tekan  atau  ke Lihat Detail dan tekan  untuk memilih.



PEMBERITAHUAN:

Wi-Fi WPA-Personal dan WPA-Enterprise menampilkan detail yang berbeda atas Titik Akses Jaringan.

Wi-Fi WPA-Personal

Untuk titik akses jaringan yang terhubung, radio Anda menampilkan Service Set Identifier (SSID), Security

Mode, alamat Media Access Control (MAC), dan alamat Internet Protocol (IP).

Untuk titik akses jaringan yang tidak terhubung, radio Anda menampilkan SSID dan Security Mode.

Wi-Fi WPA-Enterprise

Untuk titik akses jaringan yang terhubung, radio Anda menampilkan SSID, Security Mode, Identity, Extended Authentication Protocol (EAP) Method, Phase 2 Authentication, Cert Name, alamat MAC, alamat IP, Gateway, DNS1, dan DNS2.

Untuk titik akses jaringan yang tidak terhubung, radio Anda menampilkan SSID, Security Mode, Identity, EAP Method, Phase 2 Authentication, dan Cert Name.







Menghapus Titik Akses Jaringan



PEMBERITAHUAN:

Tugas ini tidak bisa diterapkan ke jaringan Wi-Fi Enterprise.

Lakukan tindakan berikut ini untuk menghapus titik akses jaringan dari daftar profil.

- 1 Tekan  untuk mengakses menu.
- 2 Tekan  atau  ke WiFi dan tekan  untuk memilih.
- 3 Tekan  atau  ke Jaringan dan tekan  untuk memilih.
- 4 Tekan  atau  ke titik akses jaringan yang dipilih dan tekan  untuk memilih.
- 5 Tekan  atau  ke Hapus dan tekan  untuk memilih.

- 6 Tekan  atau  ke Ya dan tekan  untuk memilih.

Radio menampilkan pemberitahuan mini positif untuk menunjukkan bahwa titik akses jaringan yang dipilih berhasil dihapus.

Penetapan Nomor Grup Dinamis (DGNA)

Penetapan Nomor Grup Dinamis (DGNA) adalah fitur yang memungkinkan konsol menetapkan dan melepaskan grup bicara baru dari radio Anda melalui udara.

Saat konsol menetapkan DGNA ke radio Anda, radio Anda berada dalam mode DGNA:

- Nada akan berbunyi.
- Layar akan menampilkan <Alias Grup Bicara DGNA> Ditugaskan sebentar sebelum dikembalikan ke layar awal.
- Ikon DGNA akan ditampilkan pada bilah status.
- Layar awal menampilkan alias grup bicara DGNA.

Saat konsol menghapus DGNA dari radio Anda, radio Anda kembali ke grup bicara sebelumnya:

- Nada akan berbunyi.
- Layar akan menampilkan <Alias Grup Bicara DGNA> Dihapus sebentar sebelum dikembalikan ke layar awal.
- Ikon DGNA akan hilang pada bilah status.
- Layar awal menampilkan alias grup bicara sebelumnya.

Bergantung pada cara pemrograman radio Anda, Anda bisa melihat, mengedit, dan mendengarkan daftar pindai asli dan kelompok bicara non-DGNA.

Jika radio Anda berada dalam mode DGNA, menekan tombol PTT memungkinkan Anda berkomunikasi hanya dengan grup bicara DGNA saat ini. Untuk berkomunikasi dengan kelompok bicara non-DGNA sebelumnya, program tombol **Akses Satu Sentuhan**. Lihat [Melakukan Panggilan Non-DGNA di halaman 206](#).



PEMBERITAHUAN:

Tanyakan kepada dealer atau administrator sistem Anda untuk mengetahui bagaimana radio Anda diprogram.

Melakukan Panggilan DGNA

Saat radio Anda berada dalam mode DGNA, tekan tombol **PTT** untuk melakukan panggilan.

- Nada DNA akan terdengar.
- Layar menampilkan ikon DGNA dan alias grup bicara DGNA.



PEMBERITAHUAN:

Jika radio Anda tidak berada dalam mode DGNA dan Anda menekan tombol **Akses Satu Sentuhan**, radio Anda akan membunyikan nada, yang mengindikasikan kesalahan. Layar tidak berubah.

Melakukan Panggilan Non-DGNA

- 1 Tekan tombol **Akses Satu Sentuhan** terprogram.
 - Sebuah nada positif berbunyi.
 - Pengumuman Suara mengeluarkan suara Panggilan Pengganti Satu Sentuhan.
 - Layar menampilkan . <Alias Grup Bicara> dan Tekan PTT untuk sementara.



PEMBERITAHUAN:

Jika radio Anda tidak berada dalam mode DGNA dan Anda menekan tombol **Akses Satu Sentuhan**, radio Anda akan membunyikan nada negatif, yang mengindikasikan kesalahan. Layar tidak berubah.

- 2 Tekan tombol **PTT** sebelum nada negatif berbunyi dan radio kembali ke layar awal.



PEMBERITAHUAN:

Saat radio Anda berada di layar awal, menekan PTT membuat panggilan ke grup bicara DGNA.

Menerima dan Menjawab Panggilan DGNA

Apabila Anda menerima panggilan DGNA:

- Nada DNA akan terdengar.
- Tampilan menunjukkan ikon DGNA, alias grup bicara DGNA, dan alias radio.

- Radio bersuara dan panggilan masuk berbunyi melalui speaker.

1 Tekan tombol **PTT** untuk menjawab panggilan.

2 Lepaskan tombol **PTT** untuk mendengarkan.

Utilitas

Bab ini menjelaskan pengoperasian fungsi utilitas yang terdapat di radio Anda.

Tingkat Daya

Anda dapat mengatur setelan daya ke tinggi atau rendah untuk setiap saluran.

Tinggi

Setelan tinggi memungkinkan komunikasi dengan pengguna radio yang berada dalam jarak cukup jauh dari Anda.

Rendah

Setelan rendah memungkinkan komunikasi dengan radio yang terletak dalam jarak dekat.







PEMBERITAHUAN:



Fitur ini tidak tersedia dalam saluran Citizens Band yang berada dalam frekuensi yang sama.



Mengatur Tingkat Daya

Ikuti prosedur untuk mengatur tingkat daya di radio Anda.









- Lakukan salah satu langkah berikut:
 - Tekan tombol terprogram **Tingkat Daya**. Lompati langkah-langkah di bawah ini.
 - Tekan  untuk mengakses menu.

- Tekan  atau  ke **Utilitas**. Tekan  untuk memilih.

- Tekan  atau  ke **Pengaturan Radio**. Tekan  untuk memilih.

- Tekan  atau  ke **Daya**. Tekan  untuk memilih.

5 Lakukan salah satu langkah berikut:

- Tekan  atau  ke Tinggi. Tekan  untuk memilih. Layar menampilkan  di sebelah Tinggi.
- Tekan  atau  ke Rendah. Tekan  untuk memilih. Layar menampilkan  di sebelah Rendah.

6 Tekan lama  untuk kembali ke layar Awal.

Mengaktifkan atau Menonaktifkan Nada/Peringatan Radio

Anda dapat mengaktifkan dan menonaktifkan semua nada dan peringatan radio, jika diperlukan, kecuali untuk nada peringatan Darurat yang masuk. Ikuti prosedur untuk mengaktifkan atau menonaktifkan nada dan peringatan di radio Anda.

- 1 Lakukan salah satu langkah berikut:
 - Tekan tombol **Nada/Peringatan** yang terprogram. Lompati langkah-langkah berikut ini.

- Tekan  untuk mengakses menu.



2 Tekan  atau  ke Utilitas. Tekan  untuk memilih.

3 Tekan  atau  ke Pengaturan Radio. Tekan  untuk memilih.

4 Tekan  atau  ke Nada/Peringatan. Tekan  untuk memilih.

5 Tekan  atau  ke Semua Nada. Tekan  untuk memilih.



6 Tekan  untuk mengaktifkan atau menonaktifkan semua nada dan peringatan. Layar menampilkan salah satu hasil berikut ini:



- Jika diaktifkan,  muncul di sebelah Diaktifkan.
- Jika dinonaktifkan,  hilang dari sebelah Diaktifkan.



Mengaktifkan atau Menonaktifkan Nada Keypad



Ikuti prosedur untuk mengaktifkan atau menonaktifkan nada keypad di radio Anda.



- 1 Tekan  untuk mengakses menu.

- 2 Tekan  atau  ke Utilitas. Tekan  untuk memilih.

- 3 Tekan  atau  ke Pengaturan Radio. Tekan  untuk memilih.

- 4 Tekan  atau  ke Nada/Peringatan. Tekan  untuk memilih.



- 5 Tekan  atau  ke Nada Keypad. Tekan  untuk memilih.

- 6 Tekan  untuk mengaktifkan atau menonaktifkan nada keypad. Layar menampilkan salah satu hasil berikut ini:
 - Jika diaktifkan,  muncul di sebelah Diaktifkan.
 - Jika dinonaktifkan,  hilang dari sebelah Diaktifkan.
-

Mengatur Tingkat Offset Volume Nada/Peringatan

Fitur ini menyesuaikan volume nada atau peringatan agar dapat lebih tinggi atau lebih rendah dibandingkan volume suara. Ikuti prosedur untuk mengatur tingkat offset volume nada dan peringatan di radio Anda.

- 1 Tekan  untuk mengakses menu.

- 2 Tekan  atau  ke Utilitas. Tekan  untuk memilih.



3 Tekan  atau  ke Pengaturan Radio.

Tekan  untuk memilih.



4 Tekan  atau  ke Nada/Peringatan.

Tekan  untuk memilih.

5 Tekan  atau  ke Offset Vol.. Tekan  untuk memilih.

6 Tekan  atau  ke tingkat offset volume yang diinginkan.
Nada umpan balik akan berbunyi bersama setiap tingkat offset volume yang berhubungan.

7 Lakukan salah satu langkah berikut:

- Tekan  untuk memilih. Level offset volume yang diperlukan telah disimpan.
 - Tekan  untuk keluar. Perubahan dibuang.
-

Mengaktifkan atau Menonaktifkan Nada Izin Bicara

Ikuti prosedur untuk mengaktifkan atau menonaktifkan Nada Izin Bicara di radio Anda.

1 Tekan  untuk mengakses menu.

2 Tekan  atau  ke Utilitas. Tekan  untuk memilih.

3 Tekan  atau  ke Pengaturan Radio.
Tekan  untuk memilih.

4 Tekan  atau  ke Nada/Peringatan.
Tekan  untuk memilih.

5 Tekan  atau  ke Izin Bicara. Tekan  untuk memilih.







- 6 Tekan  untuk mengaktifkan atau menonaktifkan Nada Izin Bicara.

Layar menampilkan salah satu hasil berikut ini:

- Jika diaktifkan, ✓ muncul di sebelah Diaktifkan.
- Jika dinonaktifkan, ✓ hilang dari sebelah Diaktifkan.

Mengaktifkan atau Menonaktifkan Nada Penyalaan

Ikuti prosedur untuk mengaktifkan atau menonaktifkan Nada Penyalaan di radio Anda.

- 1 Tekan  untuk mengakses menu.
-
- 2 Tekan  atau  ke Utilitas. Tekan  untuk memilih.
-
- 3 Tekan  atau  ke Pengaturan Radio.
Tekan  untuk memilih.

- 4 Tekan  atau  ke Nada/Peringatan.

Tekan  untuk memilih.

- 5 Tekan  atau  ke Penyalaan. Tekan  untuk memilih.



- 6 Tekan  untuk mengaktifkan atau menonaktifkan Nada Penyalaan. Layar menampilkan salah satu hasil berikut ini:



- Jika diaktifkan, ✓ muncul di sebelah Diaktifkan.
- Jika dinonaktifkan, ✓ hilang dari sebelah Diaktifkan.



Mengatur Nada Peringatan Pesan Teks







Anda dapat mengatur nada peringatan pesan teks ke Sesaat atau Berulang untuk tiap entri dalam daftar Kontak. Ikuti prosedur untuk mengatur nada peringatan pesan teks di radio Anda.

- 1 Tekan  untuk mengakses menu.

- 2 Tekan  atau  ke Kontak. Tekan  untuk memilih.

- 3 Tekan  atau  ke alias atau ID yang diinginkan. Tekan  untuk memilih.



- 4 Tekan  atau  ke Peringatan Pesan. Tekan  untuk memilih.



- 5 Lakukan salah satu langkah berikut:
 - Tekan  atau  ke Sementara. Tekan  untuk memilih. Layar menampilkan ✓ di sebelah Sementara.
 - Tekan  atau  ke Berulang. Tekan  untuk memilih. Layar menampilkan ✓ di sebelah Berulang.



Mengubah Mode Layar





Anda dapat mengubah mode layar radio antara Siang atau Malam, sesuai kebutuhan. Fitur ini memengaruhi palet warna pada layar. Ikuti prosedur untuk mengubah mode layar radio.

- 1 Lakukan salah satu langkah berikut:
 - Tekan tombol **Mode Tampilan** terprogram. Lompati langkah-langkah berikut ini.
 - Tekan  untuk mengakses menu.

- 2 Tekan  atau  ke Utilitas. Tekan  untuk memilih.

- 3 Tekan  atau  ke Pengaturan Radio. Tekan  untuk memilih.

- 4 Tekan  atau  ke Tampilan. Tekan  untuk memilih. Layar menampilkan Mode Siang dan Mode Malam.

- 5 Tekan  atau  ke pengaturan yang diinginkan. Tekan  untuk memilih. Layar menampilkan  di sebelah pengaturan yang dipilih.
-



Mengatur Kecerahan Layar



Ikuti prosedur untuk mengatur kecerahan layar di radio Anda. Kecerahan layar tidak dapat disesuaikan bila Kecerahan Otomatis diaktifkan.

- 1 Lakukan salah satu langkah berikut:
- Tekan tombol **Kecerahan** terprogram. Lompati langkah-langkah berikut ini.
 - Tekan  untuk mengakses menu.
-

- 2 Tekan  atau  ke **Utilitas**. Tekan  untuk memilih.
-

- 3 Tekan  atau  ke Pengaturan Radio. Tekan  untuk memilih.
-

- 4 Tekan  atau  ke Kecerahan. Tekan  untuk memilih. Layar menampilkan bilah kemajuan.
-

- 5 Tekan  atau  untuk mengurangi atau menambah kecerahan layar. Tekan  untuk memilih. Nilai pengaturan bervariasi, mulai dari 1 sampai 8.
-

Mengaktifkan atau Menonaktifkan Klakson/Lampu



Radio dapat memberi tahu Anda bila ada panggilan masuk melalui fitur klakson dan lampu. Jika diaktifkan, panggilan masuk akan membunyikan klakson dan menyalakan lampu kendaraan. Fitur ini harus dipasang melalui konektor aksesoris belakang pada radio oleh dealer. Ikuti prosedur



untuk mengaktifkan atau menonaktifkan klakson dan lampu pada radio Anda.

1 Lakukan salah satu langkah berikut:

- Tekan tombol **Klakson/Lampu** yang telah diprogram. Lompati langkah-langkah di bawah ini.
- Tekan  untuk mengakses menu.

2 Tekan  atau  ke **Utilitas**. Tekan  untuk memilih.

3 Tekan  atau  ke **Pengaturan Radio**. Tekan  untuk memilih.

4 Tekan  atau  ke **Klakson/Lampu**. Tekan  untuk memilih.

5 Tekan  untuk mengaktifkan atau menonaktifkan Klakson/Lampu. Layar menampilkan salah satu hasil berikut ini:

- Jika diaktifkan, ✓ muncul di sebelah **Diaktifkan**.
- Jika dinonaktifkan, ✓ hilang dari sebelah **Diaktifkan**.



Mengaktifkan atau Menonaktifkan Indikator LED

Ikuti prosedur untuk mengaktifkan atau menonaktifkan indikator LED di radio Anda.

1 Tekan  untuk mengakses menu.

2 Tekan  atau  ke **Utilitas**. Tekan  untuk memilih.

3 Tekan  atau  ke **Pengaturan Radio**. Tekan  untuk memilih.

4 Tekan  atau  ke **Indikator LED**. Tekan  untuk memilih.

- 5 Tekan  untuk mengaktifkan atau menonaktifkan Indikator LED.

Layar menampilkan salah satu hasil berikut ini:

- Jika diaktifkan, ✓ muncul di sebelah Diaktifkan.
- Jika dinonaktifkan, ✓ hilang dari sebelah Diaktifkan.



Mengaktifkan atau Menonaktifkan Sistem Public Address

Ikuti prosedur untuk mengaktifkan atau menonaktifkan sistem public address (PA) internal radio Anda.

- 1 Lakukan salah satu langkah berikut:
 - Tekan tombol **Public Address** yang diprogram. Lompati langkah-langkah berikut ini.
 - Tekan  untuk mengakses menu.

- 2 Tekan  atau  ke **Utilitas**. Tekan  untuk memilih.

- 3 Tekan  atau  ke **Pengaturan Radio**. Tekan  untuk memilih.

- 4 Tekan  atau  ke **Public Address**. Tekan  untuk memilih.

- 5 Tekan  untuk mengaktifkan atau menonaktifkan **Public Address**.
 - Jika diaktifkan, ✓ muncul di sebelah Diaktifkan.
 - Jika dinonaktifkan, ✓ hilang dari sebelah Diaktifkan.

Mengaktifkan atau Menonaktifkan Sistem Public Address Eksternal



Ikuti prosedur untuk mengaktifkan atau menonaktifkan sistem public address (PA) eksternal radio Anda.

- 1 Lakukan salah satu langkah berikut:



- Tekan tombol **Public Address Ekst** yang diprogram. Lompati langkah-langkah berikut ini.
- Tekan  untuk mengakses menu.

2 Tekan  atau  ke **Utilitas**. Tekan  untuk memilih.

3 Tekan  atau  ke **Pengaturan Radio**. Tekan  untuk memilih.

4 Tekan  atau  ke **Public Address Eksternal**. Tekan  untuk memilih.

5 Tekan  untuk mengaktifkan atau menonaktifkan public address eksternal.

- Jika diaktifkan,  muncul di sebelah **Diaktifkan**.
- Jika dinonaktifkan,  hilang dari sebelah **Diaktifkan**.

Mengaktifkan atau Menonaktifkan Layar Pengantar

Anda bisa mengaktifkan dan menonaktifkan Layar Pengantar dengan mengikuti prosedur ini.

1 Tekan  untuk mengakses menu.

2 Tekan  atau  ke **Utilitas**. Tekan  untuk memilih.

3 Tekan  atau  ke **Pengaturan Radio**. Tekan  untuk memilih.

4 Tekan  atau  ke **Tampilan**. Tekan  untuk memilih.



5 Tekan  atau  ke **Layar Pengantar**. Tekan  untuk memilih.

- 6 Tekan  untuk mengaktifkan atau menonaktifkan Layar Pengantar.

Layar menampilkan salah satu hasil berikut ini:







- Jika diaktifkan, ✓ muncul di sebelah Diaktifkan.
- Jika dinonaktifkan, ✓ hilang dari sebelah Diaktifkan.

- 4 Tekan  atau  ke Bahasa. Tekan  untuk memilih.

- 5 Tekan  atau  ke bahasa yang diinginkan. Tekan  untuk memilih. Layar menampilkan ✓ di sebelah bahasa yang dipilih.







Mengatur Bahasa



Ikuti prosedur untuk mengatur bahasa di radio Anda.

- 1 Tekan  untuk mengakses menu.
-
- 2 Tekan  atau  ke Utilitas. Tekan  untuk memilih.
-
- 3 Tekan  atau  ke Pengaturan Radio. Tekan  untuk memilih.

Mengidentifikasi Jenis Kabel

Lakukan langkah berikut untuk memilih jenis kabel yang digunakan pada radio Anda.

- 1 Tekan  untuk mengakses menu.
-
- 2 Tekan  atau  ke Utilitas. Tekan  untuk memilih.
-
- 3 Tekan  atau  ke Pengaturan Radio. Tekan  untuk memilih.

4 Tekan  atau  ke Jenis Kabel. Tekan  untuk memilih.

5 Jenis kabel saat ini akan ditandai dengan .

Mengaktifkan atau Menonaktifkan Pengumuman Suara

Fitur ini mengaktifkan radio agar memberikan indikasi audio tentang zona atau saluran saat ini yang ditetapkan oleh pengguna, atau tombol yang dapat diprogram yang ditekan oleh pengguna.

Ini biasanya berguna ketika pengguna kesulitan untuk membaca konten yang ditampilkan di layar.

Indikator audio dapat diatur sesuai kebutuhan pelanggan. Ikuti prosedur untuk mengaktifkan atau menonaktifkan Pengumuman Suara di radio Anda.

Mengaktifkan atau Menonaktifkan Papan Opsi

Kemampuan papan opsi dalam setiap saluran dapat dialokasikan ke tombol yang dapat diprogram. Sebuah saluran dapat mendukung hingga 6 fitur papan opsi. Ikuti prosedur untuk mengaktifkan atau menonaktifkan papan opsi di radio Anda.

Tekan tombol **Papan Opsi** yang terprogram.

Teks ke Ucapan

Fitur Teks ke Ucapan hanya dapat diaktifkan oleh dealer atau administrator sistem Anda. Jika Teks ke Ucapan diaktifkan, fitur Pengumuman Suara dinonaktifkan secara otomatis. Jika Pengumuman Suara diaktifkan, fitur Teks ke Ucapan dinonaktifkan secara otomatis.

Fitur ini membuat radio dapat mengindikasikan fitur-fitur berikut ini melalui suara:

- Saluran Saat Ini
- Zona Saat Ini
- Fitur tombol terprogram aktif atau nonaktif



- Konten dari pesan teks yang diterima
- Konten dari Tiket Tugas yang diterima



Indikator audio dapat dikustomisasi menurut keperluan subscriber. Fitur ini biasanya berguna ketika pengguna kesulitan untuk membaca informasi yang ditampilkan di layar.



Mengatur Teks ke Ucapan

Ikuti prosedur untuk mengatur fitur Teks ke Ucapan.

- 1 Tekan  untuk mengakses menu.

- 2 Tekan  atau  ke Utilitas. Tekan  untuk memilih.

- 3 Tekan  atau  ke Pengaturan Radio.
Tekan  untuk memilih.

- 4 Tekan  atau  ke Pengumuman Suara.
Tekan  untuk memilih.

- 5 Tekan  atau  ke salah satu fitur berikut.

Tekan  untuk memilih.

Fitur yang tersedia adalah sebagai berikut:

- Semua
- Pesan
- Tiket Tugas
- Saluran
- Zona
- Tombol Program

✓ muncul di sebelah pengaturan yang dipilih.

Mengatur Pencatat Waktu Menu

Anda dapat mengatur lama waktu radio Anda berada di menu sebelum otomatis beralih ke layar Awal. Ikuti prosedur untuk mengatur pencatat waktu menu.



- 1 Tekan  untuk mengakses menu.

2 Tekan  atau  ke Utilitas. Tekan  untuk memilih.

3 Tekan  atau  ke Pengaturan Radio. Tekan  untuk memilih.

4 Tekan  atau  ke Tampilan. Tekan  untuk memilih.

5 Tekan  atau  ke Pencatat Waktu Menu. Tekan  untuk memilih.

6 Tekan  atau  ke pengaturan yang diinginkan. Tekan  untuk memilih.

Mengaktifkan atau Menonaktifkan AGC Mikrofon Digital

Automatic Gain Control (AGC) Mikrofon Digital mengontrol gain mikrofon pada radio secara otomatis ketika melakukan transmisi pada sistem digital.

Fitur ini menekan audio yang keras atau mempertegas audio yang halus ke nilai yang telah ditetapkan untuk menghasilkan tingkat audio yang konsisten. Ikuti prosedur untuk mengaktifkan atau menonaktifkan AGC Mikrofon Digital di radio Anda.

1 Tekan  untuk mengakses menu.

2 Tekan  atau  ke Utilitas. Tekan  untuk memilih.

3 Tekan  atau  ke Pengaturan Radio. Tekan  untuk memilih.

4 Tekan  atau  ke Mic AGC-D. Tekan  untuk memilih.

- 5 Tekan  untuk mengaktifkan atau menonaktifkan AGC Mikrofon Digital.

Layar menampilkan salah satu hasil berikut ini:

- Jika diaktifkan, ✓ muncul di sebelah Diaktifkan.
- Jika dinonaktifkan, ✓ hilang dari sebelah Diaktifkan.

Mengaktifkan atau Menonaktifkan Audio Cerdas

Radio akan menyesuaikan volume audio secara otomatis untuk mengatasi derau latar belakang yang ada di lingkungan, termasuk sumber derau stasioner maupun non-stasioner. Ini adalah fitur hanya-terima dan tidak memengaruhi audio transmisi. Ikuti prosedur untuk mengaktifkan atau menonaktifkan Audio Cerdas di radio Anda.



PEMBERITAHUAN:



Fitur ini tidak tersedia saat sesi Bluetooth berlangsung.

- 1 Lakukan salah satu langkah berikut:



- Tekan tombol **Audio Cerdas** yang telah diprogram. Lompati langkah-langkah di bawah ini.
- Tekan  untuk mengakses menu.



- 2 Tekan  atau  ke Utilitas. Tekan  untuk memilih.

- 3 Tekan  atau  ke Pengaturan Radio. Tekan  untuk memilih.

- 4 Tekan  atau  ke Audio Cerdas. Tekan  untuk memilih.











- 5 Lakukan salah satu langkah berikut:

- Tekan  atau  ke Aktif. Tekan  untuk memilih. Layar menampilkan ✓ di sebelah Aktif.

- Tekan  atau  ke Nonaktif. Tekan  untuk memilih. Layar menampilkan ✓ di sebelah Nonaktif.



Mengaktifkan atau Menonaktifkan Fitur Peredam Umpan Balik Akustik

Fitur ini membuat Anda dapat meminimalkan umpan balik akustik di panggilan yang diterima.

- 1 Tekan  untuk mengakses menu.
- 2 Tekan  atau  ke Utilitas dan tekan  untuk memilih.
- 3 Tekan  atau  ke Pengaturan Radio dan tekan  untuk memilih.
- 4 Tekan  atau  ke Peredam AF dan tekan  untuk memilih.

Anda juga bisa menggunakan tombol atau untuk mengubah opsi yang dipilih.

5 Lakukan salah satu dari langkah berikut.

- Tekan  untuk mengaktifkan Peredam Umpan balik Akustik. Layar menampilkan ✓ di sebelah Diaktifkan.
- Tekan  untuk menonaktifkan Peredam Umpan Balik Akustik. Tanda ✓ hilang dari sebelah Diaktifkan.

Mengaktifkan atau Menonaktifkan Peningkatan Trill

Anda dapat mengaktifkan fitur ini jika berbicara dalam bahasa yang memiliki banyak kata dengan bunyi getar ("R"). Ikuti prosedur untuk mengaktifkan atau menonaktifkan Peningkatan Trill di radio Anda.

- 1 Lakukan salah satu langkah berikut:
 - Tekan tombol **Peningkatan Trill** terprogram. Lompati langkah-langkah di bawah ini.







- Tekan  untuk mengakses menu.

- 2 Tekan  atau  ke Utilitas. Tekan  untuk memilih.

- 3 Tekan  atau  ke Pengaturan Radio. Tekan  untuk memilih.

- 4 Tekan  atau  ke Peningkatan Trill. Tekan  untuk memilih.

- 5 Lakukan salah satu langkah berikut:

- Tekan  atau  ke Aktif. Tekan  untuk memilih. Layar menampilkan  di sebelah Aktif.
- Tekan  atau  ke Nonaktif. Tekan  untuk memilih. Layar menampilkan  di sebelah Nonaktif.

Ambien Audio

Anda dapat mengatur ambien audio sesuai dengan keadaan di sekitar.

Default

Ini adalah pengaturan default.

Keras

Pengaturan ini mengaktifkan Peredam Derau dan meningkatkan kekerasan speaker untuk penggunaan di lingkungan yang bising.

Grup Kerja

Pengaturan ini mengaktifkan Peredam AF dan menonaktifkan AGC ketika digunakan di dekat beberapa radio lain.

Mengatur Ambien Audio

Ikuti prosedur untuk mengatur ambien audio di radio Anda sesuai dengan lingkungan.

- 1 Tekan  untuk mengakses menu.



- 2 Tekan  atau  ke Utilitas. Tekan  untuk memilih.

3 Tekan  atau  ke Pengaturan Radio.

Tekan  untuk memilih.

4 Tekan  atau  ke Ambien Audio. Tekan

 untuk memilih.

5 Tekan  atau  ke pengaturan yang diinginkan. Tekan  untuk memilih.

Pengaturannya adalah sebagai berikut.

- Pilih **Default** untuk pengaturan pabrik default.
- Pilih **Keras** untuk meningkatkan kekerasan volume speaker saat digunakan di lingkungan sekitar yang bising.
- Pilih **Grup Kerja** untuk mengurangi umpan balik akustik saat digunakan dengan sekelompok radio yang saling berdekatan.

Layar menampilkan  di sebelah pengaturan yang dipilih.

Profil Audio

Anda dapat mengatur profil audio untuk radio sesuai dengan preferensi Anda.

Default

Ini adalah pengaturan default.

Tingkat 1, Tingkat 2, dan Tingkat 3

Pengaturan ini dimaksudkan sebagai kompensasi atas hilangnya pendengaran akibat derau yang lazim pada usia 40-an, 50-an, dan 60-an atau lebih.

Treble Boost, Mid Boost, dan Bass Boost

Pengaturan ini dimaksudkan untuk menghasilkan suara lebih kecil, suara lebih sengau, dan suara lebih dalam.

Mengatur Profil Audio

Ikuti prosedur untuk menentukan profil audio default di radio Anda.

1 Tekan  untuk mengakses menu.



2 Tekan  atau  ke **Utilitas**. Tekan  untuk memilih.

3 Tekan  atau  ke Pengaturan Radio.

Tekan  untuk memilih.

4 Tekan  atau  ke Profil Audio. Tekan

 untuk memilih.

5 Tekan  atau  ke pengaturan yang diinginkan. Tekan  untuk memilih.

Pengaturannya adalah sebagai berikut.

- Pilih **Default** untuk menonaktifkan profil audio yang dipilih sebelumnya dan kembali ke pengaturan pabrik default.
- Pilih **Level 1**, **Level 2**, atau **Level 3** untuk profil audio yang ditujukan untuk mengompensasi berkurangnya daya dengar akibat kebisingan yang lazim ditemui pada orang dewasa berusia di atas 40 tahun.
- Pilih **Treble Boost**, **Mid Boost**, atau **Bass Boost** untuk profil audio yang selaras dengan

preferensi Anda untuk suara yang lebih tipis, sengau, atau dalam.

Layar menampilkan  di sebelah pengaturan yang dipilih.

Mengaktifkan atau Menonaktifkan Global Navigation Satellite System

Global Navigation Satellite System (GNSS) adalah sistem navigasi satelit yang menentukan lokasi radio dengan tepat. GNSS mencakup Global Positioning System (GPS) dan BeiDou Navigation Satellite System (BDS).



PEMBERITAHUAN:

Model radio tertentu mungkin menawarkan GPS dan BDS. Konstelasi GNSS dikonfigurasi menggunakan CPS. Tanyakan kepada dealer atau administrator sistem Anda untuk mengetahui bagaimana radio Anda diprogram.

- 1 Lakukan salah satu langkah berikut untuk mengaktifkan atau menonaktifkan GNSS di radio Anda.
 - Tekan tombol terprogram **GNSS**.



- Tekan  untuk mengakses menu. Lanjutkan ke langkah berikutnya.
-

2 Tekan  atau  ke Utilitas. Tekan  untuk memilih.

3 Tekan  atau  ke Pengaturan Radio. Tekan  untuk memilih.

4 Tekan  atau  ke GNSS. Tekan  untuk memilih.

5 Tekan  untuk mengaktifkan atau menonaktifkan GNSS.

Jika diaktifkan,  muncul di sebelah Diaktifkan.
Jika dinonaktifkan,  hilang dari sebelah Diaktifkan.

Informasi Umum Radio

Radio Anda memuat informasi tentang berbagai parameter umum.

Informasi umum radio Anda adalah sebagai berikut:

- Alias dan ID radio.
- Versi Firmware dan Codeplug.
- Pembaruan perangkat lunak.
- Informasi GNSS.
- Informasi site.



PEMBERITAHUAN:

Tekan  untuk kembali ke layar sebelumnya.

Tekan lama  untuk kembali ke layar Awal.
Radio keluar dari layar saat ini setelah pencatat waktu nonaktif berakhir.

Memeriksa Alias dan ID Radio

Ikuti prosedur untuk memeriksa alias dan ID radio pada radio Anda.

- 1 Lakukan salah satu langkah berikut:

- Tekan tombol **Alias dan ID Radio** yang telah diprogram. Lompati langkah-langkah berikut ini. Nada indikator positif akan berbunyi.

Anda juga dapat menekan tombol **Alias dan ID Radio** yang terprogram untuk kembali ke layar sebelumnya.

- Tekan  untuk mengakses menu.

2 Tekan  atau  ke **Utilitas**. Tekan  untuk memilih.

3 Tekan  atau  ke **Info Radio**. Tekan  untuk memilih.

4 Tekan  atau  ke **ID Saya**. Tekan  untuk memilih.

Baris teks pertama menunjukkan alias radio. Baris teks kedua menampilkan ID radio.

Memeriksa Versi Firmware dan Codeplug

Ikuti prosedur untuk memeriksa versi firmware dan codeplug pada radio Anda.

1 Tekan  untuk mengakses menu.

2 Tekan  atau  ke **Utilitas**. Tekan  untuk memilih.

3 Tekan  atau  ke **Info Radio**. Tekan  untuk memilih.



4 Tekan  atau  ke **Versi**. Tekan  untuk memilih.



Layar menampilkan versi firmware dan codeplug yang sekarang.



Memeriksa Informasi Pembaruan Perangkat Lunak

Fitur ini menampilkan tanggal dan waktu pembaruan perangkat lunak terakhir yang dilakukan melalui OTAP atau Wi-Fi. Ikuti prosedur untuk memeriksa informasi pembaruan perangkat lunak pada radio Anda.

- 1 Tekan  untuk mengakses menu.

- 2 Tekan  atau  ke Utilitas. Tekan  untuk memilih.

- 3 Tekan  atau  ke Info Radio. Tekan  untuk memilih.

- 4 Tekan  atau  ke Pembaruan Perangkat Lunak. Tekan  untuk memilih.
Layar menampilkan tanggal dan waktu pembaruan perangkat lunak terbaru.



Menu Pembaruan Perangkat Lunak hanya tersedia setelah setidaknya satu sesi OTAP atau Wi-Fi yang berhasil. Lihat [Pemrograman Melalui Udara di halaman 495](#) untuk informasi selengkapnya.

Memeriksa Informasi GNSS

Menampilkan informasi GNSS di radio, misalnya nilai:



- Garis Lintang
- Garis Bujur
- Ketinggian
- Arah
- Kecepatan
- HDOP (Penipisan Ketepatan secara Horizontal)
- Satelit
- Versi

- 1 Tekan  untuk mengakses menu.

- 2 Tekan  atau  ke Utilitas. Tekan  untuk memilih.

3 Tekan  atau  ke Info Radio. Tekan  untuk memilih.

4 Tekan  atau  ke Info GNSS. Tekan  untuk memilih.

5 Tekan  atau  ke item yang diperlukan.
Tekan  untuk memilih. Informasi GNSS yang diminta akan ditampilkan di layar.

Menampilkan Informasi Site

Ikuti prosedur untuk menampilkan nama site tempat radio Anda berada saat ini.

1 Tekan  untuk mengakses menu.

2 Tekan  atau  ke Utilitas. Tekan  untuk memilih.

3 Tekan  atau  ke Info Radio. Tekan  untuk memilih.

4 Tekan  atau  ke Info Site. Tekan  untuk memilih.

Nama site saat ini akan ditampilkan di layar.

Melihat Detail Sertifikat Wi-Fi Enterprise

Anda bisa melihat detail Sertifikat Wi-Fi Enterprise terpilih.

1 Tekan  untuk mengakses menu.

2 Tekan  atau  ke Utilitas. Tekan  untuk memilih.

3 Tekan  atau  ke Menu Sertifikat.
Tekan  untuk memilih.

✓ tampak di samping sertifikat yang siap.

4 Tekan  atau  ke sertifikat yang diinginkan.

Tekan  untuk memilih.

Radio Anda menampilkan detail lengkap dari sertifikat.



PEMBERITAHUAN:

Untuk sertifikat yang belum siap, layar hanya menampilkan Status.

Pengoperasian Connect Plus

Connect Plus adalah solusi trunking penuh berdasarkan teknologi DMR. Connect Plus menggunakan saluran kontrol tersendiri untuk permintaan dan pengalokasian saluran. Fitur yang tersedia untuk pengguna radio pada sistem ini tersedia dalam bab ini.

Kontrol Radio Tambahan dalam Mode Connect Plus

Bab ini menjelaskan kontrol radio tambahan yang tersedia untuk pengguna radio melalui alat terprogram seperti tombol yang dapat diprogram dan fungsi radio yang dapat ditetapkan.

Tombol Tekan untuk Berbicara (Push-to-Talk/PTT)

Tombol **PTT** di sisi radio menjalankan dua tujuan dasar:

- Ketika panggilan sedang berlangsung, tombol **PTT** memungkinkan radio melakukan transmisi ke radio lainnya dalam panggilan tersebut.

Tekan dan tahan tombol **PTT** untuk berbicara. Lepaskan tombol **PTT** untuk mendengarkan.

Mikrofon aktif jika tombol **PTT** ditekan.

- Ketika panggilan tidak sedang berlangsung, tombol **PTT** digunakan untuk melakukan panggilan baru (lihat [Melakukan Panggilan Radio di halaman 249](#)).

Jika Nada Izin Bicara diaktifkan, tunggu hingga nada peringatan singkat berakhir sebelum berbicara.

Tombol yang Dapat Diprogram

Dealer Anda dapat memprogram tombol dapat diprogram sebagai pintasan ke fungsi-fungsi radio bergantung pada durasi penekanan tombol:

Tekan sebentar

Menekan dan melepas dengan cepat.

Tekan lama

Menekan dan menahan selama durasi terprogram.



PEMBERITAHUAN:

Durasi yang sudah diprogram untuk sebuah penekanan tombol berlaku bagi semua fungsi radio/utilitas atau pengaturan yang dapat ditetapkan. Lihat [Pengoperasian Darurat di halaman 285](#) untuk informasi selengkapnya tentang durasi terprogram untuk tombol *Darurat*.

Fungsi Radio yang Dapat Ditetapkan

Sakelar Audio Bluetooth®

Mengalihkan perutean audio antara speaker radio internal dan aksesori berkemampuan Bluetooth eksternal.

Hubungkan Bluetooth

Menginisiasi operasi pencarian dan sambungan Bluetooth.

Putus Sambungan Bluetooth

Menghentikan semua sambungan Bluetooth yang ada antara radio dan perangkat berkemampuan Bluetooth.

Bluetooth Dapat Ditemukan

Memungkinkan radio memasuki Mode Bluetooth Dapat Ditemukan.

Pembatalan Antrean Sibuk

Keluar dari mode sibuk ketika panggilan non-Darurat dalam Antrean Sibuk dimulai. Panggilan Darurat, setelah diterima dalam Antrean Sibuk, tidak dapat dibatalkan.

Log Panggilan

Memilih daftar log panggilan.

Pengumuman Saluran

Memutar pesan suara pengumuman zona dan saluran untuk saluran saat ini.

Kontak

Memberikan akses langsung ke daftar Kontak.

Darurat Aktif/Nonaktif

Menginisiasi atau membatalkan status darurat, tergantung pemrogramannya.

Klakson/Lampu

Mengaktifkan atau menonaktifkan fitur klakson dan lampu.

Lokasi Dalam Ruangan

Mengaktifkan atau menonaktifkan Lokasi Dalam Ruangan.

Audio Cerdas

Mengaktifkan atau menonaktifkan audio cerdas.

Panggilan Manual

Menginisiasi Panggilan Privat atau Telepon dengan memasukkan ID subscriber atau nomor telepon, tergantung pemrogramannya.

Akses Satu Sentuhan

Langsung memulai Panggilan Pribadi yang telah ditentukan, Peringatan Panggilan, pesan Teks Cepat, atau Balik Depan.

Privasi

Mengaktifkan atau menonaktifkan privasi.

Pemeriksaan Radio

Menentukan apakah radio aktif dalam sistem.

Pengaktifan Radio

Memungkinkan radio target diaktifkan dari jauh.

Penonaktifan Radio

Memungkinkan radio target dinonaktifkan dari jauh.

Monitor Jarak Jauh

Mengaktifkan mikrofon radio target tanpa indikator apapun.

Atur Ulang Saluran Home

Menyiapkan saluran home baru.

Jenis Tanda Dering

Memberikan akses langsung ke Pengaturan Jenis Tanda Dering.

Permintaan Jelajah

Meminta pencarian site berbeda.

Pemindaian

Mengaktifkan atau menonaktifkan pemindaian.

Senyapkan Pengingat Saluran Home

Mematikan suara Pengingat Saluran Home.

Kunci Site Aktif/Nonaktif

Ketika diaktifkan, radio akan mencari site saat ini saja. Ketika dinonaktifkan, radio akan mencari site lain di samping site saat ini.

Pesan Teks

Memilih menu pesan teks.

Pengumuman Suara Aktif/Nonaktif

Mengaktifkan atau menonaktifkan pengumuman suara.

Wi-Fi

Mengaktifkan atau menonaktifkan Wi-Fi.

Zona

Memungkinkan pemilihan dari daftar zona.

Fungsi Utilitas atau Pengaturan yang Dapat Ditetapkan

Peredam AF

Mengaktifkan atau menonaktifkan fitur Peredam Umpan Balik Akustik.

Semua Nada/Peringatan

Mengaktifkan atau menonaktifkan semua nada dan peringatan.

Kecerahan Lampu Latar

Mengatur tingkat kecerahan.

Saluran Naik/Turun

Tergantung pemrogramannya, mengubah saluran ke saluran sebelumnya atau berikutnya.

Mode Tampilan

Mengaktifkan atau menonaktifkan mode tampilan siang/malam hari.

Global Navigation Satellite System (GNSS)

Mengaktifkan atau menonaktifkan sistem navigasi satelit.

Tingkat Daya

Mengganti antara tingkat kekuatan transmisi tinggi dan rendah.

Tidak Ditetapkan

Menunjukkan bahwa fungsi tombol belum ditetapkan.

Mengidentifikasi Indikator Status dalam Mode Connect Plus

Ikon Layar

Berikut ini adalah ikon-ikon yang terdapat di layar radio.













Indikator Kekuatan Sinyal yang Diterima (Received Signal Strength Indicator/RSSI)

Jumlah baris yang ditampilkan menunjukkan kekuatan sinyal radio. Empat baris menunjukkan sinyal terkuat. Ikon ini hanya ditampilkan saat menerima.











Bluetooth Tidak Tersambung

Fitur Bluetooth diaktifkan, tetapi tidak ada perangkat Bluetooth jauh yang tersambung.

	<p>Bluetooth Tersambung</p> <p>Fitur Bluetooth diaktifkan. Ikon akan menyala bila perangkat Bluetooth jauh tersambung.</p>	<p>Daftar Notifikasi berisi item untuk diperiksa.</p>
	<p>Data Volume Tinggi</p> <p>Radio menerima data volume tinggi dan saluran sedang sibuk.</p>	<p>L atau H Tingkat Daya</p> <p>Radio diatur pada daya Rendah atau Radio diatur pada daya Tinggi.</p>
	<p>Lokasi Dalam Ruang Tersedia⁴</p> <p>Status lokasi dalam ruangan aktif dan tersedia.</p>	<p> Nada Nonaktif</p> <p>Nada dinonaktifkan.</p>
	<p>Lokasi Dalam Ruang Tidak Tersedia⁴</p> <p>Status lokasi dalam ruangan aktif tetapi tidak tersedia karena Bluetooth dinonaktifkan atau Beacons Scan dihentikan oleh Bluetooth.</p>	<p> Papan Opsi</p> <p>Papan Opsi diaktifkan.</p>
	<p>Mode Bisu</p> <p>Mode Bisu aktif dan speaker dibisukan.</p>	<p> Papan Opsi Tidak Berfungsi</p> <p>Papan Opsi dinonaktifkan.</p>
	<p>Notifikasi</p>	<p> GNSS Tersedia</p> <p>Fitur GPS/GNSS diaktifkan. Ikon akan terus menyala bila posisi tetap telah tersedia.</p>
		<p> GNSS Tidak Tersedia/Di Luar Jangkauan</p>

⁴ Hanya berlaku untuk model dengan perangkat lunak dan perangkat keras terbaru

	Fitur GPS/GNSS telah diaktifkan, tetapi tidak menerima data dari satelit.
	BeiDou Only Tersedia ⁵ Fitur BeiDou Only diaktifkan. Ikon akan terus menyala bila posisi tetap telah tersedia.
	Pemindaian Fitur Pindai diaktifkan.
	Darurat Radio dalam mode Darurat.
	Aman Fitur Privasi diaktifkan.
	Tidak Aman Fitur Privasi dinonaktifkan.
	Jelajah Site Fitur jelajah site diaktifkan.

	Kontak Kontak radio tersedia.
	Log Panggilan Log panggilan radio.
	Pesan Pesan masuk.
	Hanya Dering Mode dering diaktifkan.
	Dering Tanpa Bunyi Mode dering tanpa bunyi diaktifkan.
	Getar Mode getar diaktifkan.
	Getar dan Dering Mode Getar dan Dering diaktifkan.
	Wi-Fi Sangat Baik ⁶ Sinyal Wi-Fi sangat baik.



⁵ Hanya berlaku untuk XiR M8660i/XiR M8668i/CM7668i

	Wi-Fi Baik ⁶ Sinyal Wi-Fi baik.
	Wi-Fi Cukup ⁶ Sinyal Wi-Fi cukup.
	Wi-Fi Jelek ⁶ Sinyal Wi-Fi jelek.
	Wi-Fi Tidak Tersedia ⁶ Sinyal Wi-Fi tidak tersedia.

Ikon Panggilan

Ikon berikut muncul di layar radio Anda selama panggilan. Ikon ini juga muncul di daftar Kontak untuk menunjukkan jenis ID.

	Panggilan Pribadi Menunjukkan Panggilan Pribadi sedang berlangsung. Di Daftar Kontak, ini
---	---

	menunjukkan alias (nama) atau ID (nomor) subscriber.
	Panggilan Grup/Site All Call Menunjukkan Panggilan Grup atau Site All Call sedang berlangsung. Dalam daftar Kontak, ini ditunjukkan sebagai alias (nama) atau ID (nomor) grup.
	Panggilan Telepon sebagai Panggilan Pribadi Menunjukkan Panggilan Telepon sebagai Panggilan Pribadi sedang berlangsung.
	Panggilan PC Bluetooth Menunjukkan Panggilan PC Bluetooth sedang berlangsung. Dalam daftar Kontak, ini ditunjukkan sebagai alias (nama) atau ID (nomor) Panggilan PC Bluetooth.

⁶ Hanya berlaku untuk XiR M8668i/CM7668i





Panggilan Pengiriman

Jenis kontak Panggilan Pengiriman digunakan untuk mengirim pesan teks ke PC pengirim melalui Server Pesan Teks pihak ketiga.





Ikon Menu Lanjutan





Ikon berikut ini muncul di samping item menu yang menawarkan pilihan di antara dua opsi atau sebagai indikasi bahwa ada sub-menu yang menawarkan dua opsi.

	Kotak Centang (Kosong) Menunjukkan opsi tidak dipilih.
	Kotak Centang (Dicentang) Menunjukkan opsi dipilih.
	Kotak Hitam Penuh Menunjukkan opsi dipilih untuk item menu dengan submenu.

Ikon Item Terkirim

Ikon berikut muncul di sudut kanan atas layar radio dalam folder Item Terkirim.



	Berhasil Terkirim Pesan teks berhasil terkirim.
ATA U 	
	Sedang Berlangsung <ul style="list-style-type: none"> • Pesan teks ke alias atau ID grup sedang menunggu transmisi. • Pesan teks ke alias atau ID subscriber sedang menunggu transmisi, diikuti dengan menunggu respons.
ATA U 	
	Pesan Terpisah atau Grup Telah Dibaca Pesan teks telah dibaca.
ATA	

U 	
ATA U 	Pesan Terpisah atau Grup Belum Dibaca Pesan teks belum dibaca.
 ATA U 	Gagal Terkirim Pesan teks belum dikirim.

Ikon Perangkat Bluetooth

Ikon berikut juga ditampilkan di sebelah item dalam daftar perangkat berkemampuan Bluetooth yang tersedia untuk menunjukkan jenis perangkat.

	Perangkat Data Bluetooth
---	---------------------------------

	Perangkat data berkemampuan Bluetooth, misalnya scanner.
	Perangkat Audio Bluetooth Perangkat audio berkemampuan Bluetooth, misalnya headset.
	Perangkat PTT Bluetooth Perangkat PTT berkemampuan Bluetooth, misalnya POD (PTT-Only Device).

Indikator LED

Indikator LED menunjukkan status operasional radio.

Merah berkedip	Radio sedang melakukan transmisi pada kondisi baterai lemah, menerima transmisi darurat atau gagal dalam uji mandiri setelah dinyalakan, atau telah berpindah di luar jangkauan jika radio dikonfigurasi dengan Sistem Transponder Auto-Range. Mode Bisu aktif.
-----------------------	---

Merah berkedip cepat	Radio menerima transfer file lewat udara (file firmware Papan Opsi, file Frekuensi Jaringan, atau file Codeplug Papan Opsi), atau sedang dalam pemutakhiran ke file firmware Papan Opsi yang baru.
Berkedip hijau dan kuning	Radio menerima Peringatan Panggilan, menerima pesan teks atau Pemindaian diaktifkan dan sedang menerima aktivitas.
Kuning terus	Radio dalam Mode Bluetooth Dapat Ditemukan.
Berkedip ganda kuning	Radio secara aktif mencari site baru.
Berkedip kuning	Radio sedang menerima Peringatan Panggilan atau Pemindaian diaktifkan dan sedang siaga (tidak diaktifkan untuk aktivitas).
Hijau tak berkedip	Radio sedang menyala atau melakukan transmisi.
Berkedip hijau	Radio sedang menyala, menerima panggilan atau data.



Hijau berkedip Dua Kali	Radio menerima panggilan dengan privasi diaktifkan.
--------------------------------	---

Nada Indikator

Berikut ini adalah nada yang keluar melalui speaker radio.





Nada tinggi Nada rendah

Nada indikator memberi petunjuk suara tentang status setelah suatu tindakan untuk menjalankan tugas dilakukan.

	Nada Indikator Positif
	Nada Indikator Negatif

Nada Peringatan

Nada peringatan memberi Anda indikasi status radio yang bisa didengar atau respons radio terhadap data yang diterima.

Nada Terus Menerus 	Nada monoton. Berbunyi secara terus-menerus sampai dihentikan.
Nada Berkala 	Berbunyi secara berkala bergantung pada durasi yang diatur oleh radio. Nada memulai, berhenti, dan mengulang sendiri.
Nada Berulang 	Nada tunggal yang berulang dengan sendirinya sampai dihentikan oleh pengguna.
Nada Sesaat 	Berbunyi hanya sekali selama periode singkat yang ditentukan oleh radio.

Beralih Antara Mode Connect Plus dan Non-Connect Plus

Untuk beralih ke mode non-Connect Plus, Anda harus pindah ke zona lain, jika diprogram oleh dealer atau administrator sistem Anda. Tanyakan kepada dealer atau administrator sistem Anda untuk mengetahui apakah radio Anda telah diprogram dengan zona non-Connect Plus, dan fitur apa yang tersedia saat beroperasi di zona non-Connect Plus.

Melakukan dan Menerima Panggilan dalam Mode Connect Plus

Bagian ini menjelaskan operasi dan fitur panggilan radio secara umum yang tersedia di radio Anda.

Memilih Site

Site menyediakan jangkauan untuk area spesifik. Site Connect Plus memiliki sebuah pengontrol site dan maksimal 15 repeater. Dalam jaringan multisite, radio Connect Plus akan otomatis mencari site baru ketika

tingkat sinyal dari site saat ini turun ke tingkat yang tak bisa diterima.

Permintaan Jelajah

Permintaan Jelajah memberi tahu radio untuk mencari site yang berbeda, meski sinyal dari site saat ini dapat diterima.

Jika tidak ada site yang tersedia:

- Radio menampilkan Mencari dan Alias Saluran yang Dipilih dan melanjutkan pencarian ke seluruh daftar site.
- Radio akan kembali ke site sebelumnya, jika site sebelumnya masih tersedia.



PEMBERITAHUAN:

Hal ini diprogram oleh dealer Anda.

Tekan tombol **Permintaan Jelajah** yang terprogram.

Anda mendengar nada, yang menunjukkan radio telah beralih ke site baru. Layar menampilkan ID Site <Nomor Site>.

Kunci Site Aktif/Nonaktif

Ketika diaktifkan, radio akan mencari site saat ini saja. Ketika dinonaktifkan, radio akan mencari site lain di samping site saat ini.

Tekan tombol **Kunci Site**.

Jika fungsi **Kunci Site** diaktifkan:

- Anda mendengar nada indikator positif, yang menunjukkan radio telah dikunci ke site saat ini.
- Layar akan menampilkan Site Terkunci.

Jika fungsi **Kunci Site** dinonaktifkan:

- Anda mendengar nada indikator negatif, menandakan bahwa radio tidak terkunci.
- Layar akan menampilkan Site Tidak Terkunci.

Batasan Site

Administrator sistem radio Connect Plus Anda memiliki kemampuan untuk menentukan site jaringan mana yang boleh dan tidak boleh digunakan radio Anda. Radio Anda tidak perlu diprogram ulang untuk mengubah daftar site

yang dibolehkan dan tidak dibolehkan. Jika radio Anda mencoba mendaftar ke site yang tidak diperbolehkan, Anda akan melihat pesan singkat berbunyi: Nomor <site yang diberikan> Tidak Diizinkan. Radio kemudian mencari site jaringan yang berbeda.





Memilih Zona

Radio dapat diprogram dengan maksimum 16 Zona Connect Plus dan setiap zona Connect Plus berisi maksimum 16 posisi yang dapat ditetapkan pada Kenop Pemilih Saluran.

Setiap posisi kenop yang dapat ditetapkan dapat digunakan untuk memulai salah satu jenis panggilan suara berikut:





- Panggilan Grup
- Panggilan Multi-grup
- Semua Panggilan Site
- Panggilan Pribadi

1 Akses fitur Zona dengan melakukan yang berikut:

Kontrol Radio	Langkah
Tombol Pemilihan Zona terprogram	Tekan tombol Pemilihan Zona terprogram.
Menu radio	<p>a Tekan  untuk mengakses menu.</p> <p>b Tekan  atau  ke Zona dan tekan  untuk memilih.</p>

Zona saat ini ditampilkan dan ditandai dengan .

2 Pilih zona yang diinginkan.

Kontrol Radio	Langkah
 atau 	Tekan  atau  dan gulir ke zona yang diinginkan.

3 Tekan  untuk memilih.

Layar sesaat menampilkan pesan <Zona>
Terpilih dan kembali ke layar zona yang dipilih.

Menggunakan Beberapa Jaringan

Jika radio Anda telah diprogram untuk menggunakan beberapa jaringan Connect Plus, Anda dapat memilih jaringan yang berbeda dengan beralih ke zona Connect Plus yang ditetapkan ke jaringan yang diinginkan. Penetapan jaringan-ke-zona ini dikonfigurasi oleh dealer Anda melalui pemrograman radio.

Memilih Jenis Panggilan

Gunakan Kenop Pemilih Saluran untuk memilih jenis panggilan. Ini adalah Panggilan Grup, Panggilan Multi-grup, Semua Panggilan atau Panggilan Pribadi, bergantung pada pemrograman radio Anda. Jika Anda ubah Kenop Pemilih Saluran ke posisi yang berbeda (yang memiliki jenis panggilan yang telah ditetapkan), ini menyebabkan radio untuk mendaftar ulang ke site Connect Plus. Radio akan mendaftar dengan ID Grup Registrasi

yang telah diprogram untuk posisi Kenop Pemilih Saluran jenis panggilan baru.

Jika Anda memilih posisi yang tidak memiliki penetapan jenis panggilan, radio akan membunyikan nada berkelanjutan dan layar akan menampilkan Tidak Terprogram. Radio Anda tidak beroperasi ketika dipilih ke saluran yang tidak diprogram, gunakan Kenop Pemilih Saluran untuk memilih saluran yang telah diprogram.

Setelah zona yang diinginkan ditampilkan (jika Anda memiliki beberapa zona di radio), putar Kenop Pemilih Saluran terprogram untuk memilih jenis panggilan.

Menerima dan Menjawab Panggilan Radio

Setelah saluran, ID subscriber, atau tipe panggilan ditampilkan, Anda dapat menerima dan merespons panggilan.

Lampu LED menyala hijau terus ketika radio sedang mengirimkan transmisi dan berkedip ketika radio sedang menerima.

**PEMBERITAHUAN:**

Lampu LED menyala hijau terus ketika radio sedang mengirimkan transmisi dan berkedip ganda saat radio menerima panggilan dengan privasi diaktifkan. Untuk menguraikan panggilan dengan privasi aktif, radio harus memiliki Kunci Privasi, atau Nilai Kunci dan ID Kunci yang sama (diprogram oleh dealer) seperti radio yang melakukan transmisi (radio yang mengirimkan panggilan kepada Anda).

Lihat [Privasi di halaman 304](#) untuk informasi selengkapnya.

Menerima dan Menjawab Panggilan Grup

Untuk menerima panggilan dari sebuah grup, radio Anda harus dikonfigurasi sebagai bagian dari grup itu.

Jika Anda menerima Panggilan Grup (ketika di Layar Awal), LED berkedip hijau. Ikon Panggilan Grup muncul di sudut kanan atas. Baris teks pertama menampilkan alias pemanggil. Baris teks kedua menunjukkan alias panggilan

grup. Radio Anda bersuara lagi dan panggilan masuk terdengar melalui speaker radio.

- 1 Pegang mikrofon 1 sampai 2 inci (2,5 sampai 5,0 cm) dari mulut Anda.

Lampu LED menyala hijau tak berkedip.

- 2 Tunggu hingga salah satu dari Nada Izin Bicara selesai (jika diaktifkan) dan bicaralah dengan jelas ke mikrofon.

- 3 Lepaskan tombol **PTT** untuk mendengarkan.

Jika tidak ada aktivitas suara selama jangka waktu yang telah ditentukan, panggilan akan berakhir.

**PEMBERITAHUAN:**

Lihat [Melakukan Panggilan Grup di halaman 250](#) untuk detail tentang melakukan Panggilan Grup.

Menerima dan Menjawab Panggilan Pribadi

Panggilan Pribadi adalah sebuah panggilan dari radio perorangan ke radio perorangan lainnya.

Saat Anda menerima Panggilan Pribadi, LED akan berkedip hijau. Baris pertama layar menampilkan alias atau ID subscriber, dan ikon RSSI. Baris kedua menampilkan Panggilan Pribadi dan ikon Panggilan Pribadi. Radio bersuara dan panggilan masuk berbunyi melalui speaker radio.

- 1 Pegang mikrofon 1 sampai 2 inci (2,5 sampai 5,0 cm) dari mulut Anda.

- 2 Tekan tombol **PTT** untuk menjawab panggilan. Lampu LED menyala hijau tak berkedip.

- 3 Tunggu hingga Nada Izin Bicara selesai (jika diaktifkan), dan bicaralah dengan jelas ke mikrofon.

- 4 Lepaskan tombol **PTT** untuk mendengarkan.

Jika tidak ada aktivitas suara selama jangka waktu yang telah ditentukan, panggilan akan berakhir.

Layar menampilkan pesan Panggilan Diakhiri.

Lihat [Melakukan Panggilan Pribadi di halaman 250](#) untuk detail tentang melakukan Panggilan Pribadi.

Menerima Semua Panggilan Site

Semua Panggilan Site adalah panggilan dari sebuah radio ke semua radio yang ada site tersebut. Panggilan ini digunakan untuk membuat pengumuman penting yang memerlukan perhatian penuh dari pengguna.

Ketika Anda menerima Semua Panggilan Site, nada akan berbunyi dan LED berkedip hijau.

Ikon Panggilan Grup muncul di sudut kanan atas. Baris teks pertama menampilkan alias pemanggil. Baris teks kedua menampilkan Semua Panggilan Site. Radio Anda bersuara lagi dan panggilan masuk terdengar melalui speaker radio.

Setelah Semua Panggilan Site berakhir, radio akan kembali ke layar sebelumnya sebelum menerima panggilan. Sebuah Semua Panggilan tidak menunggu selama periode waktu yang ditentukan sebelumnya sebelum berakhir.

Anda tidak dapat merespons Semua Panggilan Site.

**PEMBERITAHUAN:**

Lihat [Melakukan Semua Panggilan Site di halaman 251](#) untuk informasi lengkap tentang melakukan Semua Panggilan Site.

Radio berhenti menerima Semua Panggilan Site tersebut jika Anda beralih ke saluran lain ketika menerima panggilan tersebut. Selama Semua Panggilan Site, Anda tidak akan bisa menggunakan semua fungsi tombol yang terprogram sampai panggilan tersebut berakhir.

Menerima Panggilan Telepon Pribadi Inbound

Ketika Anda menerima Panggilan Telepon Pribadi Inbound, ikon Panggilan Telepon sebagai Panggilan Pribadi muncul di sudut kanan atas. Baris pertama teks menampilkan Panggilan Telepon.

- 1 Tekan dan tahan tombol **PTT** untuk menjawab dan berbicara. Lepaskan tombol **PTT** untuk mendengarkan.

- 2 Tekan lama  untuk mengakhiri panggilan. Baris pertama layar menampilkan Mengakhiri. Baris kedua layar menampilkan Panggilan Telepon.... Tampilan akan kembali ke layar Panggilan Telepon. Layar menampilkan pesan Panggilan Telepon Diakhiri.

Melakukan Buffered Over-Dial dalam Panggilan Pribadi Telepon Inbound

Selama panggilan, ikon Panggilan Telepon sebagai Panggilan Pribadi muncul di sudut kanan atas. Baris pertama layar menampilkan Panggilan Telepon.

- 1 Gunakan keypad untuk memasukkan digit dan tekan tombol  .

Tekan  diikuti  dalam 2 detik untuk menyisipkan jeda. P menggantikan * dan # pada layar.

Ikon Panggilan Telepon sebagai Panggilan Pribadi muncul di sudut kanan atas. Baris pertama layar menampilkan digit yang dimasukkan.

- 2 Tekan lama  untuk mengakhiri panggilan.

Baris pertama layar menampilkan Mengakhiri. Baris kedua layar menampilkan Panggilan Telepon.... Tampilan akan kembali ke layar Panggilan Telepon.

Layar menampilkan pesan Panggilan Telepon Diakhiri.

Melakukan Live Over-Dial dalam Panggilan Pribadi Telepon Inbound

Selama panggilan, ikon Panggilan Telepon sebagai Panggilan Pribadi muncul di sudut kanan atas. Baris pertama layar menampilkan Panggilan Telepon.

- 1 Tekan tombol **PTT** dan gunakan keypad untuk memasukkan digit.

Ikon Panggilan Telepon sebagai Panggilan Pribadi muncul di sudut kanan atas. Baris pertama teks pada layar menunjukkan digit Live Dial.

- 2 Tekan lama  untuk mengakhiri panggilan.

Baris pertama layar menampilkan Mengakhiri. Baris kedua layar menampilkan Panggilan Telepon.... Tampilan akan kembali ke layar Panggilan Telepon.

Layar menampilkan pesan Panggilan Telepon Diakhiri.

Menerima Panggilan Telepon Grup Bicara Inbound

Jika Anda menerima Panggilan Telepon Grup Bicara Inbound, ikon Panggilan Grup di sudut kanan atas muncul. Baris teks pertama akan menampilkan `Memanggil1`.

Tekan tombol **PTT** untuk berbicara dan lepaskan untuk mendengarkan.

Panggilan Telepon Multi-grup Inbound

Ketika Anda menerima Panggilan Telepon Multi-Grup Inbound, ikon Panggilan Grup muncul di sudut kanan atas. Baris pertama teks menampilkan `Panggilan Multi-grup`. Radio bersuara dan panggilan multi-grup yang masuk berbunyi melalui speaker radio.

Melakukan Panggilan Radio

Setelah memilih saluran, Anda dapat memilih alias atau ID subscriber, atau alias atau ID grup menggunakan:

- Kenop Pemilih Saluran.
- Tombol **Akses Satu Sentuhan** terprogram – Fitur Akses Satu Sentuhan memungkinkan Anda membuat

Panggilan Pribadi ke ID yang telah ditentukan sebelumnya dengan mudah. Fitur ini dapat ditetapkan untuk tombol yang dapat diprogram dengan menekan singkat atau lama. Anda hanya dapat memiliki satu ID yang ditentukan ke tombol **Akses Satu Sentuhan**. Radio Anda bisa mempunyai beberapa tombol **Akses Satu Sentuhan** terprogram.

- Daftar Kontak (lihat [Pengaturan Kontak di halaman 273](#)).



PEMBERITAHUAN:

Fitur Privasi radio Anda harus sudah diaktifkan pada saluran tersebut untuk mengirim transmisi dengan privasi diaktifkan. Hanya radio target dengan Nilai Kunci dan ID Kunci yang sama dengan radio Anda yang dapat mengurai transmisi.

Lihat [Privasi di halaman 304](#) untuk informasi selengkapnya.

Melakukan Panggilan dengan Kenop Pemilih Saluran

Fitur ini memungkinkan pengguna radio melakukan jenis panggilan yang berbeda: Panggilan Grup, Panggilan Pribadi, Semua Panggilan Site, Panggilan Multi-Grup.

Melakukan Panggilan Grup

Untuk melakukan panggilan ke sebuah grup pengguna, radio Anda harus dikonfigurasi sebagai bagian dari grup itu.

- 1 Pilih saluran dengan alias atau ID grup aktif. Lihat [Memilih Jenis Panggilan di halaman 244](#).
- 2 Pegang mikrofon 1 sampai 2 inci (2,5 sampai 5,0 cm) dari mulut Anda.
- 3 Tekan tombol **PTT** untuk melakukan panggilan. LED menyala hijau tak berkedip. Ikon Panggilan Grup muncul di sudut kanan atas. Baris teks pertama memperlihatkan alias panggilan grup.
- 4 Tunggu hingga Nada Izin Bicara selesai (jika diaktifkan), dan bicaralah dengan jelas ke mikrofon.
- 5 Lepaskan tombol **PTT** untuk mendengarkan. Bila radio target merespons, LED akan berkedip hijau, suara radio akan diaktifkan, dan respons akan berbunyi melalui speaker radio. Anda melihat ikon

Panggilan Grup, alias atau ID grup, dan alias atau ID transmisi radio pada layar Anda.

Jika tidak ada aktivitas suara selama jangka waktu yang telah ditentukan, panggilan akan berakhir. Radio kembali ke layar sebelum Anda melakukan panggilan.

Melakukan Panggilan Pribadi

Meskipun Anda dapat menerima dan/atau merespons Panggilan Pribadi yang dibuat melalui radio individual yang diotorisasi, tetapi radio Anda harus diprogram untuk memulai Panggilan Pribadi.

Anda akan mendengar nada indikator negatif apabila melakukan Panggilan Pribadi menggunakan tombol **Akses Satu Sentuhan**, atau Kenop Pemilih Saluran, jika fitur ini tidak diaktifkan.

- 1 Lakukan salah satu dari langkah berikut.
 - Pilihlah saluran dengan alias atau ID subscriber yang aktif. Lihat [Memilih Jenis Panggilan di halaman 244](#).
 - Tekan tombol **Akses Satu Sentuhan** terprogram.

2 Pegang mikrofon 1 sampai 2 inci (2,5 sampai 5,0 cm) dari mulut Anda.

3 Tekan tombol **PTT** untuk melakukan panggilan. Lampu LED menyala hijau tak berkedip. Ikon Panggilan Pribadi akan ditampilkan di sudut kanan atas. Baris teks pertama menunjukkan alias subscriber target. Baris teks kedua menampilkan status panggilan.

4 Tunggu hingga Nada Izin Bicara selesai (jika diaktifkan), dan bicaralah dengan jelas ke mikrofon.

5 Lepaskan tombol **PTT** untuk mendengarkan. Bila radio target merespons, LED akan berkedip hijau. Jika tidak ada aktivitas suara selama jangka waktu yang telah ditentukan, panggilan akan berakhir. Anda akan mendengar nada pendek. Layar menampilkan pesan Panggilan Diakhiri.

Radio mungkin telah diprogram untuk melakukan pemeriksaan kehadiran radio sebelum mengonfigurasi Panggilan Pribadi. Jika radio target tidak tersedia, nada

singkat akan berbunyi dan pemberitahuan singkat negatif akan ditampilkan.

Melakukan Semua Panggilan Site

Fitur ini memungkinkan Anda untuk melakukan transmisi ke semua pengguna pada site yang saat ini tidak melakukan panggilan lain. Radio harus diprogram agar Anda bisa menggunakan fitur ini.

Pengguna pada saluran/site ini tidak bisa menjawab Semua Panggilan Site.

1 Pilih saluran dengan alias grup Semua Panggilan Site aktif. Lihat [Memilih Jenis Panggilan di halaman 244](#).

2 Pegang mikrofon 1 sampai 2 inci (2,5 sampai 5,0 cm) dari mulut Anda.

3 Tekan tombol **PTT** untuk melakukan panggilan. Lampu LED menyala hijau tak berkedip. Ikon Panggilan Grup muncul di sudut kanan atas. Baris teks pertama menampilkan Semua Panggilan Site.

- 4 Tunggu hingga Nada Izin Bicara selesai (jika diaktifkan), dan bicaralah dengan jelas ke mikrofon.
-

Melakukan Panggilan Multi-grup

Fitur ini memungkinkan Anda melakukan transmisi ke semua pengguna pada beberapa grup. Radio harus diprogram agar Anda bisa menggunakan fitur ini.



PEMBERITAHUAN:

Pengguna di grup tidak dapat merespons Panggilan Multi-grup.

- 1 Putar Kenop Pemilih Saluran untuk memilih alias atau ID Multi-grup.
-

- 2 Tekan tombol **PTT** untuk melakukan panggilan.

Lampu LED menyala hijau tak berkedip. Layar menampilkan alias atau ID Multi-grup.

Tunggu hingga Nada Izin Bicara selesai (jika diaktifkan) dan bicaralah dengan jelas ke mikrofon.

Melakukan Panggilan Pribadi dengan Tombol Panggilan Satu Sentuhan



PEMBERITAHUAN:

Penekanan tombol yang dapat diprogram harus dilakukan dari layar Awal.

Fitur Panggilan Satu Sentuhan memungkinkan Anda untuk melakukan Panggilan Pribadi dengan mudah ke alias Panggilan Pribadi atau ID yang sudah ditentukan. Fitur ini dapat ditetapkan untuk tombol yang dapat diprogram dengan menekan singkat atau lama.

Anda HANYA dapat menetapkan satu alias atau ID ke tombol Panggilan Satu Sentuhan. Radio Anda dapat memiliki beberapa tombol Panggilan Satu Sentuhan yang diprogram.

- 1 Tekan tombol **Panggilan Satu Sentuhan** untuk melakukan Panggilan Pribadi ke alias atau ID Panggilan Pribadi yang telah ditentukan sebelumnya.
-

- 2 Pegang mikrofon 1 sampai 2 inci (2,5 sampai 5,0 cm) dari mulut Anda.
-

- 3 Tekan tombol **PTT** untuk melakukan panggilan.
Lampu LED menyala hijau tak berkedip.
Layar akan menampilkan alias atau ID Panggilan Pribadi.

-
- 4 Tunggu hingga Nada Izin Bicara selesai (jika diaktifkan) dan bicaralah dengan jelas ke mikrofon.

-
- 5 Lepaskan tombol **PTT** untuk mendengarkan.
Ketika radio target menjawab, LED berkedip hijau.
Jika tidak ada aktivitas suara selama jangka waktu yang telah ditentukan, panggilan akan berakhir.

Melakukan Panggilan dengan Tombol Panggil Manual yang Dapat Diprogram

Fitur ini memungkinkan pengguna radio melakukan panggilan pribadi menggunakan tombol panggilan manual yang dapat diprogram.

Melakukan Panggilan Pribadi

- 1 Tekan tombol **Panggilan Manual** terprogram untuk masuk ke layar Panggilan Manual.

Layar akan menampilkan Nomor: .

-
- 2 Gunakan keypad untuk memasukkan alias atau ID Pribadi subscriber.

-
- 3 Pegang mikrofon 1 sampai 2 inci (2,5 sampai 5,0 cm) dari mulut Anda.

-
- 4 Tekan tombol **PTT** untuk melakukan panggilan.
Lampu LED menyala hijau tak berkedip. Ikon Panggilan Pribadi muncul di sudut kanan atas. Baris teks pertama menunjukkan alias subscriber. Baris teks kedua menunjukkan status panggilan.

-
- 5 Tunggu hingga Nada Izin Bicara selesai (jika diaktifkan) dan bicaralah dengan jelas ke mikrofon.

-
- 6 Lepaskan tombol **PTT** untuk mendengarkan.
Ketika radio target menjawab, LED berkedip hijau.



Jika tidak ada aktivitas suara selama jangka waktu yang telah ditentukan, panggilan akan berakhir. Anda akan mendengar nada pendek. Layar menampilkan pesan Panggilan Diakhiri.

Melakukan Panggilan Telepon Pribadi Outbound dengan Tombol Pemanggil Dapat Diprogram

- 1 Tekan tombol **Panggilan Manual** terprogram untuk masuk ke layar Panggilan Manual.

Layar akan menampilkan Nomor:.

- 2 Gunakan keypad untuk memasukkan nomor telepon, dan tekan  untuk memanggil nomor yang dimasukkan.

Tekan  untuk menghapus karakter yang tidak diinginkan. Tekan  diikuti  dalam 2 detik

untuk menyisipkan jeda. P menggantikan * dan # pada layar.

Jika berhasil, baris pertama layar menampilkan Panggilan Telepon. Baris kedua pada layar menampilkan nomor telepon yang dipanggil.

Jika nomor yang dipilih ternyata tidak valid, layar menampilkan pemberitahuan mini negatif Panggilan Telepon Gagal, Sumber Daya Tidak Tersedia, atau Izin Tidak Valid.

Jika  ditekan tanpa memasukkan nomor telepon, radio mengeluarkan nada indikator positif, lalu nada indikator negatif. Layar tidak berubah.



- 3 Tekan lama  untuk mengakhiri panggilan.

Baris pertama layar menampilkan Mengakhiri. Baris kedua layar menampilkan Panggilan Telepon....

Layar menampilkan pesan Panggilan Telepon Diakhiri.



Melakukan Panggilan Telepon Pribadi Outbound melalui Menu Telepon

- 1 Tekan  untuk mengakses menu.

- 2 Tekan  atau  ke Telepon dan tekan  untuk memilih.

- 3 Tekan  untuk memilih Panggilan Manual.
Baris pertama layar menampilkan Nomor, baris kedua layar menampilkan kursor yang berkedip.

- 4 Gunakan keypad untuk memasukkan nomor telepon, dan tekan  untuk memanggil nomor yang dimasukkan.

Tekan  untuk menghapus karakter yang tidak diinginkan. Tekan  diikuti  dalam 2 detik

untuk menyisipkan jeda. P menggantikan * dan # pada layar.

Jika berhasil, baris pertama layar menampilkan Panggilan Telepon. Baris kedua pada layar menampilkan nomor telepon yang dipanggil.

Jika nomor yang dipilih ternyata tidak valid, layar menampilkan pemberitahuan mini negatif Panggilan Telepon Gagal, Sumber Daya Tidak Tersedia, atau Izin Tidak Valid.

Jika  ditekan tanpa memasukkan nomor telepon, radio mengeluarkan nada indikator positif, lalu nada indikator negatif. Layar tidak berubah.

- 5 Tekan lama  untuk mengakhiri panggilan.
Baris pertama layar menampilkan Mengakhiri. Baris kedua layar menampilkan Panggilan Telepon....

Layar menampilkan pesan Panggilan Telepon Diakhiri.



Melakukan Panggilan Telepon Pribadi Outbound dari Kontak









PEMBERITAHUAN:

Jika Panggilan Manual pada Papan Opsi CPS MOTOTRBO Connect Plus dinonaktifkan, item Nomor Telepon **tidak akan** ditampilkan di Menu.

- 1 Tekan  untuk mengakses menu.



- 2 Tekan  atau  ke Kontak dan tekan  untuk memilih.

- 3 Tekan  atau  ke Panggilan Manual dan tekan  untuk memilih.

- 4 Tekan  atau  ke Nomor Telepon dan tekan  untuk memilih.
Baris pertama layar menampilkan Nomor, baris kedua layar menampilkan kursor yang berkedip.

- 5 Gunakan keypad untuk memasukkan nomor telepon, dan tekan  untuk memanggil nomor yang dimasukkan.

Jika tombol **PTT** ditekan, layar menampilkan pemberitahuan mini negatif, Tekan OK untuk Mengirim dan kembali ke layar sebelumnya.

Tekan  untuk menghapus karakter yang tidak diinginkan. Tekan  diikuti  dalam 2 detik untuk menyisipkan jeda. P menggantikan * dan # pada layar.

Jika berhasil, baris pertama layar menampilkan Panggilan Telepon. Baris kedua pada layar menampilkan nomor telepon yang dipanggil.

Jika  ditekan tanpa memasukkan nomor telepon, radio mengeluarkan nada indikator positif, lalu nada indikator negatif. Layar tidak berubah.

- 6 Tekan lama  untuk mengakhiri panggilan.
Baris pertama layar menampilkan Mengakhiri.
Baris kedua layar menampilkan Panggilan Telepon....
Layar menampilkan pesan Panggilan Telepon Diakhiri.

Jika tidak berhasil, layar menampilkan pemberitahuan mini negatif Panggilan Telepon Gagal, Sumber Daya Tidak Tersedia, atau Izin Tidak Valid.

- Tekan lama  untuk mengakhiri panggilan.
Tampilan kembali ke layar sebelumnya.



Menunggu Alokasi Saluran dalam Panggilan Telepon Pribadi Outbound

Ketika melakukan Panggilan Telepon Pribadi, baris pertama layar menampilkan Panggilan Telepon. Baris kedua pada layar menampilkan nomor telepon yang dipanggil.

Jika panggilan terhubung, ikon Panggilan Telepon sebagai Panggilan Pribadi muncul di sudut kanan atas. Baris pertama layar menampilkan nomor telepon.

Melakukan Buffered Over-Dial dalam Panggilan Telepon Pribadi Outbound Terhubung

Selama panggilan, ikon Panggilan Telepon sebagai Panggilan Pribadi muncul di sudut kanan atas. Baris pertama layar menampilkan nomor telepon.

- Gunakan keypad untuk memasukkan digit.
Tekan  untuk menghapus karakter yang tidak diinginkan. Tekan  diikuti  dalam 2 detik

untuk menyisipkan jeda. P menggantikan * dan # pada layar.



Baris teks pertama pada layar menampilkan Digit Ekstra, baris teks kedua pada layar menampilkan digit ekstra yang dimasukkan.

2 Tekan tombol .

Jika tombol **PTT** ditekan, layar menampilkan pemberitahuan mini negatif, Tekan OK untuk Mengirim dan kembali ke layar sebelumnya.

Ikon Panggilan Telepon sebagai Panggilan Pribadi muncul di sudut kanan atas. Baris teks pertama pada layar menampilkan nomor telepon dengan digit over-dial dicantumkan.

3 Lakukan salah satu dari langkah berikut.

- Tekan  untuk kembali ke layar Panggilan Telepon.
 - Tekan lama  untuk mengakhiri panggilan.
-

Melakukan Live Over-Dial dalam Panggilan Telepon Pribadi Outbound Terhubung

Selama panggilan, ikon Panggilan Telepon sebagai Panggilan Pribadi muncul di sudut kanan atas. Baris pertama layar menampilkan nomor telepon.

1 Tekan tombol **PTT** dan gunakan keypad untuk memasukkan digit.

Ikon Panggilan Telepon sebagai Panggilan Pribadi muncul di sudut kanan atas. Baris teks pertama pada layar menampilkan nomor telepon dengan digit over-dial dicantumkan.

2 Tekan lama  untuk mengakhiri panggilan.

Baris pertama layar menampilkan Mengakhiri. Baris kedua layar menampilkan Panggilan Telepon....

Layar menampilkan pesan Panggilan Telepon Diakhiri.

Fitur Lanjutan dalam Mode Connect Plus

Bab ini menjelaskan pengoperasian fitur-fitur yang terdapat di radio Anda.

Pengingat Saluran Rumah

Fitur ini akan mengingatkan ketika radio tidak diatur ke saluran rumah selama jangka waktu tertentu.

Jika fitur ini diaktifkan menggunakan CPS, nada Pengingat Saluran Rumah dan suara pengumuman, baris pertama layar menampilkan Non dan baris kedua menampilkan Saluran Rumah secara berkala jika radio tidak diatur ke saluran rumah selama jangka waktu tertentu.

Anda dapat merespons pengingat dengan melakukan salah satu tindakan berikut:

- Kembali ke saluran rumah.
- Matikan suara pengingat untuk sementara menggunakan tombol yang dapat diprogram.
- Buat saluran rumah baru menggunakan tombol yang dapat diprogram.

Fallback Otomatis

Fallback Otomatis adalah fitur sistem yang memungkinkan Anda terus melakukan dan menerima panggilan non-darurat pada Kontak Grup terpilih saat terjadi sejumlah tipe kegagalan sistem Connect Plus.

Jika salah satu kegagalan ini terjadi, radio Anda akan mencoba menjelajah ke site Connect Plus yang lain. Proses pencarian ini dapat menyebabkan radio Anda mencari site Connect Plus yang dapat beroperasi, atau mengakibatkan radio Anda mencari sebuah "Saluran Fallback" (jika radio Anda diaktifkan untuk Fallback Otomatis). Saluran Fallback adalah repeater yang biasanya merupakan bagian dari site Connect Plus yang dapat beroperasi, tetapi saat ini tidak dapat berkomunikasi baik dengan pengontrol sitenya atau dengan jaringan Connect Plus. Dalam mode Fallback, repeater bekerja sebagai repeater digital tunggal. Mode Fallback Otomatis hanya mendukung Panggilan Grup non-darurat. Tipe panggilan lain tidak didukung dalam Mode Fallback.

Indikasi Mode Fallback Otomatis

Saat radio Anda sedang menggunakan saluran Fallback, Anda mendengar "Nada Fallback" yang terputus-putus kira-kira setiap 15 detik (kecuali sedang melakukan transmisi).

Layar secara berkala menampilkan pesan singkat, "Saluran Fallback". Radio Anda hanya mengizinkan PTT pada Kontak Grup terpilih (Panggilan Grup, Panggilan Multigrup, atau Semua Panggilan Site). Mode ini tidak membolehkan Anda melakukan jenis panggilan lain.

Melakukan/Menerima Panggilan dalam Mode Fallback



PEMBERITAHUAN:

Panggilan hanya didengar oleh radio yang sedang memantau saluran Fallback yang sama dan dipilih ke Grup yang sama. Panggilan tidak menggunakan jaringan site atau repeater lain.

Panggilan suara Darurat atau Peringatan Darurat tidak tersedia dalam mode Fallback. Jika Anda menekan tombol darurat dalam mode Fallback, radio memberikan nada salah tekan tombol. Radio yang dilengkapi layar juga akan menampilkan pesan, "Feature not available" (Fitur tidak tersedia).

Panggilan pribadi (radio ke radio) dan Telepon tidak tersedia dalam mode Fallback. Jika Anda mencoba melakukan panggilan ke kontak pribadi, Anda akan mendengar nada penolakan. Pada saat ini Anda harus memilih kontak grup yang diinginkan.

Panggilan lain yang tidak didukung meliputi Monitor Jarak Jauh, Peringatan Panggilan, Pemeriksaan Radio, Pengaktifan Radio, Penonaktifan Radio, pengolahan pesan Teks, Pembaruan Lokasi, dan panggilan data paket.

Akses Saluran Lalu Lintas yang Disempurnakan (Enhanced Traffic Channel Access/ETCA) tidak didukung dalam mode Fallback Otomatis. Jika dua pengguna radio atau lebih menekan **PTT** secara bersamaan (atau hampir bersamaan), kedua radio kemungkinan mengirim transmisi hingga **PTT** dilepas. Dalam hal ini, kemungkinan tidak akan ada transmisi yang dipahami oleh radio penerima.

Melakukan panggilan dalam mode Fallback mirip dengan fungsi normal. Cukup pilih kontak grup yang ingin Anda gunakan (menggunakan metode seleksi saluran radio secara normal), dan tekan **PTT** untuk memulai panggilan Anda. Saluran tersebut bisa jadi telah digunakan oleh grup lain. Jika saluran sedang digunakan, Anda mendengar nada sibuk dan layar akan menampilkan pesan “Saluran Sibuk”. Anda dapat memilih kontak Grup, Multi-grup, atau Semua Panggilan Site menggunakan metode pemilihan saluran radio secara normal. Saat radio sedang beroperasi pada Saluran Fallback, Multigrup akan bekerja persis seperti Grup lainnya. Radio tersebut hanya akan didengar oleh radio yang saat ini dipilih dalam Multi-grup yang sama.

Kembali ke Pengoperasian Normal

Jika site kembali ke pengoperasian trunking normal saat Anda sedang berada dalam jangkauan repeater Fallback,

radio keluar secara otomatis dari mode Fallback Otomatis. Anda akan mendengar "bip" registrasi ketika radio berhasil terdaftar. Jika berada dalam jangkauan site yang beroperasi (yang bukan dalam mode Fallback), Anda dapat menekan tombol Permintaan Roaming (jika diprogram untuk radio Anda) untuk memaksa radio mencari dan mendaftar ke site yang tersedia. Jika tidak ada site lain yang tersedia, radio kembali ke mode Fallback Otomatis setelah pencarian selesai. Jika berkendara di luar jangkauan repeater Fallback, radio masuk ke mode Pencarian (layar menunjukkan Mencari).











Pemeriksaan Radio



Jika diaktifkan, fitur ini memungkinkan Anda menentukan apakah radio lain aktif di dalam sistem tanpa mengganggu pengguna radio itu. Tidak ada pemberitahuan suara atau visual yang tampil di radio target.

Fitur ini hanya tersedia untuk alias atau ID subscriber.

Mengirimkan Pemeriksaan Radio

- 1 Akses fitur Pemeriksaan Radio.

Kontrol Radio	Langkah
Tombol Periksa Radio terprogram	<p>a Tekan tombol Pemeriksaan Radio terprogram.</p> <p>b Tekan  atau  ke alias atau ID subscriber yang diperlukan dan tekan  untuk memilih.</p>
Menu	<p>a Tekan  untuk mengakses menu.</p> <p>b Tekan  atau  ke Kontak dan tekan  untuk memilih.</p> <p>c Tekan  atau  ke alias atau ID subscriber yang diperlukan dan tekan  untuk memilih.</p>

Kontrol Radio	Langkah
	<p>d Tekan  atau  ke Pemeriksaan Radio dan tekan  untuk memilih.</p>

Layar menampilkan Alias Target, yang menunjukkan permintaan sedang diproses. Lampu LED menyala hijau tak berkedip.

2 Tunggu respons.

Jika radio target aktif dalam sistem, sebuah nada akan berbunyi dan layar akan sekilas menampilkan Radio Target Tersedia.

Jika radio target tidak aktif dalam sistem, sebuah nada akan berbunyi dan layar akan sekilas menampilkan Radio Target Tidak Tersedia.

Radio kembali ke alias subscriber atau layar ID saat dimulai melalui Menu.

Radio kembali ke Layar Awal jika dimulai melalui tombol yang bisa diprogram.

Monitor Jauh

Gunakan fitur Monitor Jauh untuk menghidupkan mikrofon pada radio target (hanya alias atau ID subscriber). LED warna hijau akan berkedip sekali pada subscriber target. Anda dapat menggunakan fitur ini untuk memantau aktivitas suara di sekitar radio target dari jauh.

Radio harus diprogram agar Anda bisa menggunakan fitur ini.

Menginisiasi Monitor Jauh









PEMBERITAHUAN:

Monitor Jauh secara otomatis berhenti setelah durasi yang telah terprogram atau ketika ada usaha untuk memulai transmisi, ubah saluran atau putuskan daya radio.

- 1 Akses fitur Monitor Jauh.

Kontrol Radio	Langkah
Tombol Monitor	a Tekan tombol Monitor Jauh terprogram.

Kontrol Radio	Langkah
Jauh Terprogram	b Tekan  atau  ke alias atau ID subscriber yang diperlukan dan tekan  untuk memilih.
Menu	<p>a Tekan  untuk mengakses menu.</p> <p>b Tekan  atau  ke Kontak dan tekan  untuk memilih.</p> <p>c Tekan  atau  ke alias atau ID subscriber yang diperlukan dan tekan  untuk memilih.</p>

Kontrol Radio	Langkah
	<p>d Tekan  atau  ke Panggilan Manual dan tekan  untuk memilih.</p> <p>e Tekan  atau  ke Mon. Jauh dan tekan  untuk memilih.</p>

Baris teks pertama akan menampilkan Rem. Monitor. Baris teks kedua menampilkan Alias Target, yang menunjukkan bahwa permintaan sedang berlangsung. Lampu LED berkedip hijau.

2 Tunggu respons.

Jika berhasil, nada indikator positif akan berbunyi dan layar akan menampilkan sesaat Monitor Jauh Berhasil. Radio akan memutar audio dari radio yang dipantau selama durasi yang telah ditetapkan dan layar akan menampilkan Mon. Jauh, yang diikuti dengan alias target. Setelah timer berakhir,

nada peringatan radio akan berbunyi dan LED akan mati.

Jika gagal, nada indikator negatif akan berbunyi dan layar akan menampilkan Monitor Jauh Gagal.

Pemindaian

Fitur ini memungkinkan radio Anda memantau dan menggabungkan panggilan untuk grup/saluran yang ditentukan dalam daftar pindai yang telah diprogram sebelumnya. Ketika pemindaian diaktifkan, ikon pemindaian akan muncul di bilah status dan LED akan berkedip kuning saat idle.

Memulai dan Menghentikan Pemindaian









PEMBERITAHUAN:

Prosedur ini Mengaktifkan atau Menonaktifkan fitur Pemindaian untuk semua zona Connect Plus dengan ID Jaringan yang sama dengan zona yang saat ini terpilih. Penting mode untuk diketahui bahwa bahkan saat fitur Pemindaian diaktifkan melalui prosedur ini, pemindaian mungkin tetap tidak aktif untuk beberapa (atau semua) grup di daftar pindai Anda. Lihat [Mengedit Daftar Pindai di halaman 267](#) untuk informasi selengkapnya.

Anda dapat memulai dan menghentikan pemindaian dengan menekan tombol **Pindai** terprogram **ATAU** ikuti prosedur yang dijelaskan berikut.

- 1 Tekan  untuk mengakses menu.

- 2 Tekan  atau  ke Pindai dan tekan  untuk memilih.

- 3 Tekan  atau  ke Nyalakan atau Matikan dan tekan  untuk memilih.
 - Layar menampilkan Pindai Mati jika pemindaian dinonaktifkan.
 - Menu Pindai menampilkan pesan Matikan jika pemindaian diaktifkan.
 - Layar menampilkan Pindai Mati ketika pemindaian dinonaktifkan.
 - Menu Pindai menampilkan pesan Nyalakan jika pemindaian dinonaktifkan.

Menjawab suatu Transmisi Selama Pemindaian

Selama pemindaian, radio berhenti pada grup tempat aktivitas terdeteksi. Radio terus menerus mendengarkan anggota di daftar pindai saat idle/diam pada saluran kontrol.

- 1 Pegang mikrofon 1 sampai 2 inci (2,5 sampai 5,0 cm) dari mulut Anda.

- 2 Tekan tombol **PTT** selama waktu hang.
Lampu LED menyala hijau tak berkedip.

- 3 Tunggu hingga Nada Izin Bicara selesai (jika diaktifkan), dan bicaralah dengan jelas ke mikrofon.

- 4 Lepaskan tombol **PTT** untuk mendengarkan.
Jika Anda tidak menjawab dalam waktu hang, radio kembali memindai grup lain.

Pemindaian yang Dapat Dikonfigurasi oleh Pengguna

Jika menu Edit Daftar diaktifkan, maka pengguna dapat Menambahkan dan Menghapus anggota pemindaian dari menu Tambah Anggota. Anggota Daftar Pindai harus merupakan Kontak Grup biasa (misalnya, bukan Multigrup atau Site Semua Panggilan/Panggilan Semua Dalam Jaringan) yang saat ini ditetapkan ke posisi Pemilih Saluran di Connect Plus Zone dengan ID Jaringan yang sama dengan Zona yang dipilih saat ini. Alias Grup Bicara juga tidak boleh sama dengan Grup Bicara yang sudah disertakan dalam Daftar Pindai Zona saat ini.

Pemindaian dapat diaktifkan atau dinonaktifkan dari menu, atau dengan menekan tombol **Pindai Aktif/Nonaktif** yang diprogram.

Fitur ini berfungsi hanya jika radio saat ini tidak sedang melakukan panggilan. Jika Anda saat ini sedang mendengarkan panggilan, radio Anda tidak dapat memindai untuk panggilan grup lain, dan karena itu tidak menyadari panggilan yang sedang berlangsung. Setelah panggilan telepon Anda selesai, radio Anda kembali ke slot waktu saluran kontrol, dan dapat memindai grup yang berada dalam daftar pindai.

Mengaktifkan atau Menonaktifkan Pemindaian







PEMBERITAHUAN:



Prosedur ini Mengaktifkan atau Menonaktifkan fitur Pemindaian untuk semua zona dengan ID Jaringan yang sama dengan zona yang saat ini terpilih. Penting mode untuk diketahui bahwa bahkan saat fitur Pemindaian diaktifkan melalui prosedur ini, pemindaian mungkin tetap tidak aktif untuk beberapa (atau semua) grup di daftar pindai Anda. Baca bagian berikut untuk informasi selengkapnya.

Jika Pemindaian diaktifkan, ikon Pemindaian akan muncul pada layar Anda. Jika Pemindaian diaktifkan dan Anda tidak sedang berpartisipasi dalam panggilan, LED akan berkedip hijau dan kuning.

Prosedur untuk mengaktifkan atau menonaktifkan Pemindaian bergantung pada bagaimana radio Anda diprogram. Jika diprogram dengan tombol Pemindaian Aktif/Nonaktif, gunakan tombol tersebut untuk mengaktifkan atau menonaktifkan fitur. Jika radio Anda telah diprogram sehingga Pemindaian dapat diaktifkan atau dinonaktifkan melalui menu, ikuti prosedur berikut ini.

- 1 Tekan  untuk mengakses menu.

- 2 Tekan  atau  ke Pindai dan tekan  untuk memilih.

- 3 Tekan  atau  ke Nyalakan atau Matikan dan tekan  untuk memilih.
 - Layar menampilkan pesan singkat Pindai Nyala ketika pemindaian dinonaktifkan.

- Layar menampilkan pesan singkat Pindai Mati ketika pemindaian dinonaktifkan.

Mengedit Daftar Pindai



PEMBERITAHUAN:

Jika entri daftar pindai adalah grup yang saat ini terpilih, radio akan mendengar aktivitas pada grup ini tanpa memperhatikan apakah entri daftar saat ini menampilkan tanda centang atau tidak. Ketika tidak sedang melakukan panggilan, radio mendengarkan aktivitas pada Grup yang Dipilih, Multigrup, Semua Panggilan Site, dan Grup Balik Darurat Default (jika dikonfigurasi untuk salah satu opsi tersebut). Pengoperasian ini tidak dapat dinonaktifkan. Jika Pindai diaktifkan, maka radio juga akan mendengarkan aktivitas pada anggota Daftar Pindai Zona yang diaktifkan.

Daftar pindai Anda menentukan grup mana yang dapat dipindai. Daftar tersebut dibuat saat radio Anda diprogram. Jika radio diprogram untuk mengizinkan pengeditan daftar pindai, Anda bisa:

- Mengaktifkan/nonaktifkan pemindaian untuk grup individual pada daftar.

- Tambah dan Hapus anggota pindai dari menu Tambah Anggota. Baca [Menambahkan atau Menghapus Grup melalui Menu Tambah Anggota di halaman 269](#).







PEMBERITAHUAN:

Anggota Daftar Pindai harus merupakan Kontak Grup biasa (bukan Multigrup atau Site Semua Panggilan/Panggilan Semua Dalam Jaringan) yang saat ini ditetapkan ke posisi Pemilih Saluran di Connect Plus Zone dengan ID Jaringan yang sama dengan Zona yang dipilih saat ini.

Alias Grup Bicara juga tidak boleh sama dengan Grup Bicara yang sudah disertakan dalam Daftar Pindai Zona saat ini.

- 1 Tekan  untuk mengakses menu.

- 2 Tekan  atau  ke Lihat/Edit Daftar dan tekan  untuk memilih.

- 3 Tekan  atau  ke nama Grup yang diinginkan.

Jika tanda centang di depan nama Grup, pemindaian sedang diaktifkan untuk Grup ini.

Jika tidak ada tanda centang di depan nama Grup, pemindaian sedang dinonaktifkan untuk Grup ini.

- 4  untuk memilih Grup yang diinginkan.

Layar menampilkan Aktifkan jika pemindaian sedang dinonaktifkan untuk Grup.

Layar menampilkan Nonaktifkan jika pemindaian sedang diaktifkan untuk Grup.

- 5 Pilih opsi yang ditampilkan (Aktifkan atau Nonaktifkan) dan tekan  untuk memilih.

Bergantung pada opsi yang mana yang dipilih, radio sementara menampilkan Pemindaian Diaktifkan atau Pemindaian Dinonaktifkan sebagai konfirmasi.



Radio menampilkan lagi daftar pindai Zona. Jika pemindaian diaktifkan untuk Grup, tanda centang ditampilkan sebelum nama Grup. Jika pemindaian dinonaktifkan untuk Grup, tanda centang tidak ada sebelum nama Grup.



Menambahkan atau Menghapus Grup melalui Menu Tambah Anggota

Radio Connect Plus tidak memungkinkan nomor grup duplikat atau alias grup duplikat ditempatkan ke daftar pindai zona (atau ditampilkan sebagai "kandidat pemindaian"). Jadi, daftar "kandidat pemindaian" yang dijelaskan dalam [langkah 6](#) dan [langkah 7](#) kadang-kadang berubah setelah grup ditambahkan atau dihapus dari daftar pemindaian zona.

Jika radio Anda telah diprogram sehingga Anda dapat mengedit daftar pindai, Anda dapat menggunakan menu Tambah Anggota untuk menambahkan grup ke daftar pindai dari zona yang saat ini terpilih, atau menghapus grup dari daftar pindai zona yang saat ini terpilih.

1 Tekan  untuk mengakses menu.



2 Tekan  atau  ke Opsi pindai dan tekan  untuk memilih.

3 Tekan  atau  ke <Tambah Anggota> dan tekan  untuk memilih.

Layar menampilkan Tambah Anggota dari Zona (n = nomor zona Connect Plus dari zona Connect Plus pertama di radio Anda dengan ID Jaringan yang sama dengan zona yang saat ini terpilih).

4 Lakukan salah satu dari langkah berikut.

- Jika grup yang ingin Anda tambahkan ke daftar pindai ditetapkan ke posisi pemilih saluran di zona tersebut, lakukan langkah [langkah 6](#).
 - Jika grup yang ingin Anda tambahkan ke daftar pindai ditetapkan ke posisi pemilih saluran di zona Connect Plus yang berbeda, lakukan langkah [langkah 5](#).
-

5 Tekan  atau  untuk menggulirkan daftar zona Connect Plus yang memiliki ID Jaringan yang sama dengan zona yang saat ini terpilih.

- 6 Setelah menemukan zona Connect Plus tempat grup yang diinginkan ditetapkan ke posisi pemilih saluran, tekan  untuk memilih.

Radio Anda akan menampilkan entri pertama dalam daftar grup yang ditetapkan ke posisi saluran di zona tersebut. Grup di daftar itu disebut "kandidat pemindaian", karena grup dapat ditambahkan ke daftar pindai zona yang saat ini terpilih (atau grup sudah berada di daftar pindai zona tersebut).

Jika zona tersebut tidak memiliki grup yang dapat ditambahkan ke daftar pindai, radio akan menampilkan Tidak ada Kandidat.

- 7 Tekan  atau  untuk menggulir daftar grup kandidat.

Jika tanda tambah (+) ditampilkan segera sebelum alias grup, hal ini berarti grup tersebut saat ini berada di daftar pindai untuk zona yang terpilih.

Jika tanda tambah (+) tidak ditampilkan segera sebelum alias, maka grup tersebut saat ini tidak berada di daftar pindai, tetapi dapat ditambahkan.

- 8 Tekan  saat alias grup yang diinginkan ditampilkan.

Jika grup ini saat ini tidak berada di daftar pindai untuk zona yang saat ini terpilih, pesan Tambah (Alias Grup) akan ditampilkan.

Jika grup ini saat sudah berada di daftar pindai untuk zona yang saat ini terpilih, pesan Hapus (Alias Group) akan ditampilkan.

- 9 Tekan  untuk menerima pesan yang ditampilkan (Tambah atau Hapus).

Jika menghapus grup dari daftar, Anda akan tahu bahwa hal itu berhasil karena tanda tambah (+) tidak akan lagi ditampilkan segera sebelum alias.

Saat menambahkan suatu grup ke daftar, Anda akan mengetahui operasi tersebut berhasil dari tanda plus (+) yang kini ada sebelum alias.

Jika Anda mencoba menambahkan sebuah grup, dan daftar sudah penuh, radio akan menampilkan Daftar Penuh. Jika hal ini terjadi, penting untuk menghapus sebuah grup dari daftar sebelum menambahkan yang baru.

- 10 Setelah selesai, tekan  sesering mungkin untuk kembali ke menu yang diinginkan.

- Anda sudah berpartisipasi dalam panggilan.
- Tidak ada anggota grup yang terpindai terdaftar di lokasi Anda (Sistem Multisite saja).

Memahami Operasi Pemindaian



PEMBERITAHUAN:

Jika Radio bergabung dalam panggilan untuk anggota Daftar Pindai Zona dari Zona berbeda dan Pencatat Waktu Hang Panggilan berakhir sebelum Anda dapat merespons, agar dapat merespons Anda harus menelusuri Zona dan Saluran dari Anggota Daftar Pindai tersebut dan memulai panggilan baru.

Ada beberapa situasi saat Anda dapat melewatkan panggilan grup yang berada dalam daftar pindai Anda. Bila Anda melewatkan panggilan karena salah satu alasan berikut, hal ini bukan menunjukkan adanya masalah dengan radio Anda. Ini adalah operasi pemindaian normal untuk Connect Plus.

- Fitur Pindai tidak diaktifkan (periksa ikon pindai pada layar).
- Anggota daftar pindai telah dinonaktifkan melalui menu (lihat [Mengedit Daftar Pindai di halaman 267](#)).

Pindai Talkback

Jika radio Anda memindai panggilan dari daftar pindai grup yang dapat dipilih, dan jika tombol **PTT** ditekan selama panggilan terpindai, pengoperasian radio tergantung pada apakah Pindai Talkback diaktifkan atau dinonaktifkan selama pemrograman radio. Tanyakan kepada penyalur atau administrator sistem Anda untuk informasi lebih lanjut.

Pindai Talkback Nonaktif

Radio keluar dari panggilan terpindai dan mencoba mentransmisikan kontak untuk posisi saluran yang sedang dipilih. Setelah Waktu Hang Panggilan pada kontak yang sedang dipilih berakhir, radio kembali ke saluran awal dan memulai Pencatat Waktu Hang Pemindaian. Radio kembali ke pemindaian grup setelah Pencatat Waktu Hang Pemindaian berakhir.

Pindai Talkback Aktif

Jika tombol **PTT** ditekan selama Waktu Hang Grup panggilan terpindai, radio akan mencoba melakukan transmisi grup terpindai.



PEMBERITAHUAN:

Jika Anda memindai panggilan untuk grup yang tidak diberi posisi saluran dalam zona yang sedang dipilih dan Anda melewatkan Waktu Hang panggilan, beralihlah ke zona yang sesuai lalu pilih posisi saluran dari grup yang ingin Anda tanggapi.

Mengedit Prioritas untuk Grup Bicara

Fitur Monitor Prioritas membuat radio dapat menerima transmisi dari grup bicara secara otomatis dengan prioritas lebih tinggi jika radio sedang dalam panggilan lain. Nada akan berbunyi jika radio beralih ke panggilan dengan prioritas lebih tinggi.



Ada dua tingkat prioritas untuk grup bicara: P1 dan P2. P1 mempunyai prioritas lebih tinggi daripada P2.









PEMBERITAHUAN:

Jika ID Grup Balik Darurat Default dikonfigurasi dalam CPS Papan Opsi MOTOTRBO Connect Plus, ada tiga tingkat prioritas untuk grup bicara: P0, P1, dan P2. P0 adalah ID Grup Balik Darurat permanen dan merupakan prioritas tertinggi. Tanyakan kepada penyalur atau administrator sistem Anda untuk informasi lebih lanjut.

- 1 Tekan  untuk mengakses menu.

- 2 Tekan  atau  ke Pindai dan tekan  untuk memilih.

- 3 Tekan  atau  ke Lihat/Edit Daftar dan tekan  untuk memilih.

- 4 Tekan  atau  ke grup bicara yang diinginkan dan tekan  untuk memilih.

5 Tekan  atau  ke Edit Prioritas dan tekan  untuk memilih.

6 Tekan  atau  ke level prioritas yang diperlukan dan tekan  untuk memilih.

Layar menampilkan pemberitahuan mini positif sebelum kembali ke layar sebelumnya. Ikon prioritas muncul di sebelah kiri grup bicara.

- Jika hanya satu zona dikonfigurasi di radio, Daftar Kontak langsung menampilkan daftar dari zona yang dipilih saat ini.
- Jika berbagai zona dikonfigurasi di radio, Folder Kontak Zona menampilkan semua zona dengan ID jaringan identik sebagai zona yang dipilih saat ini. Pengguna dapat mengakses kontak dalam tiga zona.

Kontak memberikan fitur “buku telepon” di radio Anda. Setiap entri berhubungan dengan suatu alias atau ID yang Anda gunakan untuk memulai panggilan.

Setiap zona menyediakan Daftar Kontak hingga 100 kontak. Jenis kontak berikut tersedia:

- Panggilan Pribadi
- Panggilan Grup
- Panggilan Multikelompok
- Semua Panggilan Site Suara
- Semua Panggilan Site Teks
- Panggilan Pengiriman

Jenis kontak Panggilan Pengiriman digunakan untuk mengirim pesan teks ke PC pengirim melalui Server Pesan Teks pihak ketiga.

Pengaturan Kontak







PEMBERITAHUAN:

Anda dapat menambah, atau mengedit ID subscriber untuk Kontak Connect Plus. Menghapus ID subscriber hanya bisa dilakukan oleh dealer. Jika fitur Privasi diaktifkan pada saluran, Anda dapat membuat panggilan suara dengan privasi diaktifkan pada saluran tersebut. Hanya radio target dengan Kunci Privasi yang sama, atau Nilai Kunci dan ID Kunci yang sama dengan radio Anda yang dapat menguraikan transmisi tersebut.

Akses ke Daftar Kontak tergantung pada konfigurasi zona:

Melakukan Panggilan Pribadi dari Kontak

- 1 Tekan  untuk mengakses menu.

- 2 Tekan  atau  ke Kontak dan tekan  untuk memilih.
Entri diurutkan berdasar abjad.

- 3 Pegang mikrofon 1 sampai 2 inci (2,5 sampai 5,0 cm) dari mulut Anda.

- 4 Tekan tombol **PTT** untuk melakukan panggilan.
Lampu LED menyala hijau tak berkedip.

- 5 Tunggu hingga Nada Izin Bicara selesai (jika diaktifkan), dan bicaralah dengan jelas ke mikrofon.

- 6 Lepaskan tombol **PTT** untuk mendengarkan.
Ketika radio target menjawab, LED berkedip hijau dan layar menampilkan ID pengguna pemancar.

Jika tidak ada aktivitas suara selama jangka waktu yang telah ditentukan, panggilan akan berakhir.



Anda akan mendengar nada pendek. Layar menampilkan pesan Panggilan Diakhiri.



Melakukan Pencarian Alias Panggilan

Anda juga dapat menggunakan pencarian alias atau alfanumerik untuk memperoleh alias subscriber yang diperlukan.

Fitur ini hanya tersedia saat dalam Kontak.

- 1 Tekan  untuk mengakses menu.

- 2 Tekan  atau  ke Kontak dan tekan  untuk memilih.
Entri diurutkan berdasar abjad.

- 3 Masukkan karakter pertama dari alias yang diperlukan, lalu tekan tombol  atau  untuk menemukan alias yang diperlukan.

4 Pegang mikrofon 1 sampai 2 inci (2,5 sampai 5,0 cm) dari mulut Anda.

5 Tekan tombol **PTT** untuk melakukan panggilan. Lampu LED menyala hijau tak berkedip. Layar menampilkan alias tujuan.



6 Tunggu hingga Nada Izin Bicara selesai (jika diaktifkan), dan bicaralah dengan jelas ke mikrofon.

7 Lepaskan tombol **PTT** untuk mendengarkan. Ketika radio target menjawab, LED berkedip hijau. Jika tidak ada aktivitas suara selama jangka waktu yang telah ditentukan, panggilan akan berakhir. Layar menampilkan pesan Panggilan Diakhiri.

Menambah Kontak Baru



1 Tekan  untuk mengakses menu.

2 Tekan  atau  ke Kontak dan tekan  untuk memilih.

3 Tekan  atau  ke Kontak Baru dan tekan  untuk memilih.

4 Gunakan keypad untuk memasukkan nomor kontak, lalu tekan  untuk mengonfirmasi.

5 Gunakan keypad untuk memasukkan nama kontak, lalu tekan  untuk mengonfirmasi.

6 Jika menambahkan Kontak Radio, tekan  atau  ke jenis dering yang diinginkan, dan tekan  untuk memilih. Radio membunyikan nada indikator positif dan layar menampilkan Kontak Disimpan.



Pengaturan Indikator Panggilan



Fitur ini memungkinkan pengguna radio mengonfigurasi panggilan atau pesan teks yang menderingkan nada.



Mengaktifkan dan Menonaktifkan Dering Panggilan untuk Peringatan Panggilan



Anda dapat memilih, atau menghidupkan atau mematikan nada dering untuk Peringatan Panggilan yang diterima.



- 1 Tekan  untuk mengakses menu.



- 2 Tekan  atau  ke Utilitas dan tekan  untuk memilih.

- 3 Tekan  atau  ke Pengaturan Radio dan tekan  untuk memilih.

- 4 Tekan  atau  ke Nada/Peringatan dan tekan  untuk memilih.

- 5 Tekan  atau  ke Dering Panggilan dan tekan  untuk memilih.



- 6 Tekan  atau  ke Peringatan Panggilan dan tekan  untuk memilih.
Zona saat ini akan ditandai dengan ✓.



- 7 Tekan  atau  ke nada yang diinginkan dan tekan  untuk memilih.
✓ muncul di samping nada yang dipilih.



Mengaktifkan dan Menonaktifkan Dering Panggilan untuk Panggilan Pribadi



Anda dapat menghidupkan atau mematikan nada dering untuk Panggilan Pribadi.



- 1 Tekan  untuk mengakses menu.

- 2 Tekan  atau  ke Utilitas dan tekan  untuk memilih.

3 Tekan  atau  ke Pengaturan Radio dan tekan  untuk memilih.

4 Tekan  atau  ke Nada/Peringatan dan tekan  untuk memilih.

5 Tekan  atau  ke Dering Panggilan dan tekan  untuk memilih.

6 Tekan  atau  ke Panggilan Pribadi dan tekan  untuk memilih.

7 Tekan  untuk mengaktifkan/menonaktifkan nada dering Panggilan Pribadi.



Layar menampilkan  di samping Diaktifkan, jika nada dering Panggilan Pribadi diaktifkan.



 tidak ditampilkan ketika nada dering Panggilan Pribadi dinonaktifkan.



Mengaktifkan dan Menonaktifkan Dering Panggilan untuk Pesan Teks



Anda dapat mengaktifkan atau menonaktifkan nada dering untuk Pesan Teks yang diterima.



1 Tekan  untuk mengakses menu.

2 Tekan  atau  ke Utilitas dan tekan  untuk memilih.



3 Tekan  atau  ke Pengaturan Radio dan tekan  untuk memilih.

4 Tekan  atau  ke Nada/Peringatan dan tekan  untuk memilih.

5 Tekan  atau  ke Dering Panggilan dan tekan  untuk memilih.

- 6 Tekan  atau  ke Pesan Teks dan tekan  untuk memilih.

Zona saat ini akan ditandai dengan ✓.

- 7 Tekan  atau  ke nada yang diinginkan dan tekan  untuk memilih.

✓ muncul di samping nada yang dipilih.

Memilih Jenis Tanda Dering



PEMBERITAHUAN:

Tombol terprogram **Jenis Tanda Dering** dialokasikan oleh penyalur atau administrator sistem Anda. Tanyakan kepada dealer atau administrator sistem Anda untuk mengetahui bagaimana radio Anda diprogram.

Anda dapat memprogram panggilan radio ke salah satu panggilan getar yang ditentukan sebelumnya. Jika status Semua Nada nonaktif, radio akan menampilkan ikon Semua Nada Bisu. Jika status Semua Nada aktif, jenis peringatan dering yang terkait akan ditampilkan.

Radio bergetar sekali jika nada dering sementara dipilih. Radio bergetar terus-menerus jika gaya dering berulang dipilih. Bila diatur ke Dering dan Getar, radio akan memutar nada dering tertentu jika ada aktivitas radio masuk (misalnya, Tanda Panggilan atau Pesan). Suara terdengar seperti nada indikator positif atau panggilan tak terjawab.

Volume Nada Alarm yang Semakin Tinggi

Anda bisa memprogram radio Anda untuk terus-menerus memperingatkan Anda ketika ada panggilan radio yang masih belum terjawab. Hal ini dilakukan dengan otomatis meningkatkan volume nada alarm secara berkala. Fitur ini disebut Escalert.

Log Panggilan

Radio Anda terus mencatat semua Panggilan Pribadi keluar, yang dijawab, dan yang tidak terjawab. Gunakan fitur log panggilan untuk melihat dan mengatur panggilan saat ini.



Anda dapat melakukan tugas berikut ini di masing-masing daftar panggilan Anda:



- Hapus
- Lihat Detail



Melihat Panggilan Terbaru

Daftarnya mencantumkan Tak Terjawab, Terjawab, dan Keluar.

- 1 Tekan  untuk mengakses menu.



- 2 Tekan  atau  ke Log Panggilan dan tekan  untuk memilih.



- 3 Tekan  atau  daftar yang diinginkan dan tekan  untuk memilih.
Layar menampilkan entri terbaru di bagian teratas daftar.



- 4 Tekan  atau  untuk melihat daftar.
Tekan tombol **PTT** untuk memulai Panggilan Pribadi dengan alias atau ID yang saat ini dipilih.



Menghapus Panggilan dari Daftar Panggilan





- 1 Tekan  untuk mengakses menu.

- 2 Tekan  atau  ke Log Panggilan dan tekan  untuk memilih.











- 3 Tekan  atau  ke daftar yang diinginkan dan tekan  untuk memilih.
Jika Anda memilih daftar panggilan yang tidak memiliki entri, layar akan menampilkan Daftar Kosong, dan nada rendah akan berbunyi jika Nada Keypad diaktifkan .



- 4 Tekan  atau  ke alias atau ID yang diperlukan dan tekan  untuk memilih.

- 5 Tekan  atau  ke Hapus dan tekan  untuk memilih.

- Lakukan salah satu langkah berikut:
 - Tekan  untuk memilih Ya untuk menghapus entri. Layar menampilkan Entri Dihapus.
 - Tekan  atau  ke Tidak, dan tekan tombol  untuk kembali ke layar sebelumnya.
-

Melihat Detail dari Log Panggilan

- Tekan  untuk mengakses menu.
 - Tekan  atau  ke Log Panggilan dan tekan  untuk memilih.
 - Tekan  atau  ke daftar yang diinginkan dan tekan  untuk memilih.
 - Tekan  atau  ke alias atau ID yang diperlukan dan tekan  untuk memilih.
-

- Tekan  atau  ke Lihat Detail dan tekan  untuk memilih.
Layar menunjukkan detail daftar panggilan.
-

Operasi Peringatan Panggilan

Penyerantaan Peringatan Panggilan memungkinkan Anda mengingatkan pengguna radio tertentu untuk memanggil Anda kembali ketika dia bisa melakukannya.

Fitur ini bisa diakses melalui menu menggunakan Kontak, panggilan manual, atau tombol **Akses Satu Sentuhan** terprogram.

Merespons Peringatan Panggilan

Ikuti prosedur untuk merespons Alarm Panggilan di radio Anda.

Ketika Anda menerima Peringatan Panggilan:

- Nada berulang akan berbunyi.
- LED kuning akan berkedip.

- Layar menampilkan daftar notifikasi yang berisi Peringatan Panggilan dengan alias atau ID radio pemanggil.

Tergantung konfigurasi oleh dealer atau administrator sistem, Anda dapat merespons Peringatan Panggilan dengan melakukan salah satu hal berikut:

- Tekan tombol **PTT** dan respons dengan Panggilan Pribadi secara langsung ke pemanggil.
- Tekan tombol **PTT** untuk melanjutkan komunikasi grup bicara normal. Peringatan Panggilan dipindahkan ke opsi Panggilan Tak Terjawab di menu Log. Anda dapat merespons pemanggil dari log Panggilan Tak Terjawab.







Lihat [Daftar Notifikasi di halaman 194](#) dan [Fitur Log Panggilan di halaman 132](#) untuk informasi selengkapnya.

Membuat Peringatan Panggilan dari Daftar Kontak

- 1 Tekan  untuk mengakses menu.

- 2 Tekan  atau  ke Kontak dan tekan  untuk memilih.

- 3 Gunakan salah satu langkah yang digambarkan berikut untuk memilih alias atau ID subscriber yang diperlukan:

- pilih alias subscriber secara langsung
 - Tekan  atau  ke alias yang subscriber yang diperlukan dan tekan  untuk memilih.
- gunakan menu Panggilan Manual
 - Tekan  atau  ke Panggilan Manual dan tekan  untuk memilih.
 - Layar entri teks Panggilan Manual akan ditampilkan. Masukkan ID Subscriber dan tekan .

- 4 Tekan  atau  ke Peringatan Panggilan dan tekan  untuk memilih.

Layar menampilkan Peringatan Panggilan: <Alias atau ID Subscriber>Peringatan Panggilan dan alias atau ID Subscriber, yang menunjukkan bahwa Peringatan Panggilan telah terkirim.

LED menyala hijau terus ketika radio Anda mengirim Peringatan Panggilan.

Jika pemberitahuan Peringatan Panggilan diterima, layar akan menampilkan pesan Peringatan Panggilan Berhasil.

Jika respons Peringatan Panggilan tidak diterima, layar akan menampilkan pesan Peringatan Panggilan Gagal.

Membuat Peringatan Panggilan dengan Tombol Akses Satu Sentuhan

Tekan tombol **Akses Satu Sentuhan** yang diprogram untuk membuat Peringatan Panggilan ke alias yang telah ditentukan.

Layar akan menampilkan Peringatan Panggilan dan alias atau ID subscriber, menunjukkan bahwa Peringatan Panggilan telah terkirim. LED menyala hijau terus ketika radio Anda mengirim Peringatan Panggilan.

Jika pemberitahuan Peringatan Panggilan diterima layar akan menampilkan Peringatan Panggilan Berhasil.

Jika respons Peringatan Panggilan tidak diterima, layar akan menampilkan pesan Peringatan Panggilan Gagal.

Mode Bisu

Mode Bisu memungkinkan pengguna untuk membisukan semua indikator audio di radio.

Setelah Mode Bisu aktif, semua indikator audio dibisukan, kecuali fitur dengan prioritas lebih tinggi misalnya Operasi darurat.

Setelah keluar dari Mode Bisu, radio melanjutkan pemutaran nada dan transmisi audio.



PEMBERITAHUAN:

Fitur ini dapat dibeli. Tanyakan kepada penyalur atau administrator sistem Anda untuk informasi lebih lanjut.

Mengaktifkan Mode Bisu

Ikuti prosedur untuk menonaktifkan Mode Bisu.

Akses fitur ini menggunakan tombol **Mode Bisu** terprogram.

Hal berikut mungkin terjadi saat Mode bisu aktif:

- Nada Indikator Positif Akan Berbunyi.
- Layar menampilkan Mode Bisu Aktif.
- Lampu LED berwarna merah akan terus berkedip hingga Anda keluar dari Mode Bisu.
- Layar menampilkan ikon **Mode Bisu** di layar utama.
- Radio dibisukan.



- Pewaktu Mode Bisu mulai menghitung mundur dengan durasi yang dikonfigurasi.



Menyetel Pewaktu Mode Bisu

Fitur Mode Bisu dapat diaktifkan dalam waktu yang telah dikonfigurasi terlebih dahulu dengan menyetel Pewaktu Mode Bisu. Durasi pewaktu dikonfigurasi di menu radio dengan rentang antara 0,5–6 jam. Anda akan dikeluarkan dari Mode Bisu setelah pewaktu kedaluwarsa.

Jika pewaktu habis pada angka 0, radio tetap berada dalam Mode bisu selama waktu yang tidak ditentukan hingga tombol **Mode Bisu** terprogram ditekan.

- 1 Tekan  untuk mengakses menu.

- 2 Tekan  atau  ke *Utilitas*. Tekan  untuk memilih.

- 3 Tekan  atau  ke *Pengaturan Radio*. Tekan  untuk memilih.

4 Tekan  atau  ke Pewaktu Mode Bisu.

Tekan  untuk memilih.

5 Tekan  atau  untuk mengedit nilai angka

setiap digit, lalu tekan .

- Radio menghidupkan suara dan status speaker dipulihkan.
- Jika pewaktu belum kedaluwarsa, Pewaktu mode bisu dihentikan.



PEMBERITAHUAN:

Pengguna juga dikeluarkan dari Mode Bisu jika mengirimkan suara atau beralih ke saluran yang belum terprogram.

Keluar dari Mode Bisu

Fitur ini dapat dikeluarkan secara otomatis setelah Pewaktu Mode Bisu kedaluwarsa.

Lakukan salah satu hal berikut untuk keluar dari Mode bisu secara manual:

- Tekan tombol **Mode Bisu** terprogram.
 - Tekan tombol **PTT** pada entri apa pun.
-

Hal berikut akan terjadi saat Mode bisu nonaktif:

- Nada Indikator Negatif Akan Berbunyi.
- Layar menampilkan Mode Bisu Nonaktif.
- Lampu LED berwarna merah mati.
- Ikon **Mode Bisu** hilang dari layar utama.

Pengoperasian Darurat



PEMBERITAHUAN:

Jika radio Anda diprogram untuk inisiasi darurat Senyap atau Senyap dengan Suara, radio seringkali keluar otomatis dari operasi senyap setelah Panggilan Darurat atau Peringatan Darurat selesai. Pengecualian pada aturan ini adalah bila Peringatan Darurat merupakan Mode Darurat yang dikonfigurasi dan bila Senyap merupakan Jenis Darurat yang dikonfigurasi. Jika radio Anda diprogram dengan cara ini, operasi senyap berlanjut hingga Anda membatalkan operasi senyap dengan menekan **PTT** atau tombol yang dikonfigurasikan untuk Darurat Nonaktif.

Panggilan suara darurat dan Peringatan Darurat tidak didukung saat beroperasi dalam mode Connect Plus Auto Fallback. Untuk informasi selengkapnya, lihat [Fallback Otomatis di halaman 259](#).

Peringatan Darurat digunakan untuk menunjukkan situasi genting. Anda dapat memulai fungsi Darurat kapan saja pada tampilan layar mana pun, bahkan saat ada aktivitas pada saluran saat ini. Menekan tombol **Darurat** yang terprogram akan memulai mode Darurat terprogram. Mode Darurat terprogram juga dapat dimulai dengan memicu fitur

Man Down opsional. Fitur Darurat mungkin dinonaktifkan pada radio Anda.

Dealer Anda bisa mengatur durasi penekanan tombol untuk tombol **Darurat** yang terprogram, kecuali untuk penekanan lama, yang sama dengan semua tombol lainnya:

Tekan sebentar

Antara 0,05 hingga 0,75 detik.

Tekan lama

Antara 1,00 hingga 3,75 detik.

Tombol **Darurat** ditetapkan ke fitur Darurat Aktif/Tidak Aktif. Tanyakan kepada dealer tentang pengoperasian yang ditetapkan dari tombol **Darurat**.

- Jika penekanan singkat tombol **Darurat** ditetapkan untuk menghidupkan mode Darurat, maka penekanan lama tombol **Darurat** ditetapkan untuk keluar dari mode Darurat.
- Jika penekanan lama tombol **Darurat** ditetapkan untuk menghidupkan mode Darurat, maka penekanan singkat tombol **Darurat** ditetapkan untuk keluar dari mode Darurat.

Bila dipilih ke zona Connect Plus, radio Anda mendukung tiga mode Darurat:

Panggilan Darurat

Anda harus menekan tombol **PTT** untuk berbicara pada slot waktu darurat yang ditetapkan.

Panggilan Darurat dengan Suara untuk Diikuti

Untuk transmisi pertama pada slot waktu darurat yang ditetapkan, mikrofon secara otomatis kembali terdengar dan Anda dapat berbicara tanpa menekan tombol **PTT**. Mikrofon tetap "panas" dengan mode ini selama jangka waktu yang diprogram ke radio. Untuk transmisi berikutnya dalam panggilan Darurat yang sama, Anda harus menekan tombol **PTT**.

Peringatan Darurat

Peringatan Darurat bukan merupakan panggilan suara. Ini adalah pemberitahuan darurat yang dikirimkan ke radio yang dikonfigurasi untuk menerima peringatan ini. Radio mengirimkan peringatan darurat menggunakan saluran kontrol dari lokasi yang terdaftar saat ini. Peringatan Darurat diterima oleh radio dalam jaringan Connect Plus yang diprogram untuk peringatan ini (terlepas dari lokasi jaringan tempatnya terdaftar).

Hanya salah satu dari Mode Darurat yang dapat ditetapkan ke tombol Darurat per zona. Selain itu, setiap mode Darurat memiliki jenis berikut:

Reguler

Radio memulai Darurat dan menunjukkan indikator audio dan/atau visual.

Senyap

Radio memulai Darurat tanpa indikator audio atau visual. Radio akan menahan seluruh indikasi audio atau visual panggilan Darurat hingga Anda menekan tombol **PTT** untuk memulai transmisi suara.

Senyap dengan Suara

Sama dengan pengoperasian Senyap, kecuali bahwa radio juga bersuara untuk beberapa transmisi suara.

Menerima Darurat Masuk

Radio Anda dapat diprogram untuk membunyikan nada peringatan dan juga menampilkan informasi tentang Darurat masuk. Jika diprogram, saat menerima Darurat yang masuk, layar menampilkan layar Detail Darurat dengan ikon darurat, Alias, atau ID radio yang meminta Darurat, Kontak Grup yang sedang digunakan untuk Darurat, dan satu baris informasi tambahan. Informasi tambahan adalah nama zona yang berisi Kontak Grup.

Pada saat ini, radio hanya menampilkan Darurat yang didekode baru-baru ini. Jika Darurat baru diterima sebelum



Darurat sebelumnya dibersihkan, detail Darurat baru menggantikan detail Darurat sebelumnya.

Tergantung bagaimana radio Anda diprogram, layar Detail Darurat (atau layar Daftar Alarm) akan tetap ditampilkan di layar radio Anda meskipun setelah Darurat berakhir. Anda dapat menyimpan detail darurat ke Daftar Alarm, atau menghapus detail darurat seperti yang dijelaskan di bagian berikut.



Menyimpan Detail Darurat ke Daftar Alarm

Menyimpan detail darurat ke Daftar Alarm memungkinkan Anda melihat detailnya lagi lain kali dengan memilih Daftar Alarm dari Menu Utama.

- 1 Saat layar Detail Darurat (atau Daftar Alarm) ditampilkan, tekan  .
Layar **Keluar dari Daftar Alarm** akan ditampilkan.
- 2 Lakukan salah satu tindakan berikut:

- Pilih **Ya** dan tekan  untuk menyimpan detail darurat ke Daftar Alarm, dan keluar dari layar Detail Darurat (atau Daftar Alarm).
- Pilih **Tidak** dan tekan  untuk kembali ke layar Detail Darurat (atau Daftar Alarm).

Menghapus Detail Darurat

- 1 Saat layar Detail Darurat ditampilkan, tekan  .
Layar **Hapus** ditampilkan.
- 2 Lakukan salah satu tindakan berikut:
 - Pilih **Ya** dan tekan  untuk menghapus detail darurat.
 - Pilih **Tidak** dan tekan  untuk kembali ke layar Detail Darurat.

Merespons Panggilan Darurat



PEMBERITAHUAN:

Jika Anda tidak merespons panggilan Darurat selama waktu yang dialokasikan untuk Waktu Hang Panggilan Darurat, panggilan Darurat akan selesai. Jika ingin berbicara ke grup setelah Waktu Hang Panggilan Darurat berakhir, Anda harus terlebih dahulu memilih posisi saluran yang ditetapkan ke grup (jika belum dipilih). Lalu, tekan **PTT** untuk memulai Panggilan non-Darurat ke grup.

- 1 Ketika menerima Alarm Darurat, tekan tombol untuk menghentikan semua indikasi Alarm Darurat yang diterima.

- 2 Tekan tombol **PTT** untuk memulai transmisi suara pada grup Darurat.
Semua radio yang memantau grup ini mendengar transmisi Anda.

- 3 Tunggu hingga Nada Izin Bicara selesai (jika diaktifkan) dan bicaralah dengan jelas ke mikrofon.
Lampu LED menyala hijau.

- 4 Lepaskan tombol **PTT** untuk mendengarkan.

Bila radio yang mengirim sinyal darurat merespons, LED akan berkedip hijau. Ikon Panggilan Grup, ID grup, dan ID radio yang melakukan transmisi akan ditampilkan di layar.

Merespons Peringatan Darurat



PEMBERITAHUAN:

Kontak Grup yang digunakan untuk Peringatan Darurat tidak boleh digunakan untuk komunikasi suara. Hal ini dapat mencegah radio lain mengirimkan dan menerima Peringatan Darurat pada grup yang sama.

Peringatan Darurat dari sebuah radio menunjukkan bahwa pengguna sedang berada dalam situasi mendesak. Anda dapat merespons peringatan tersebut dengan memulai panggilan pribadi ke radio yang menyatakan darurat, memulai panggilan grup ke grup bicara, mengirimkan Peringatan Panggilan, memulai Monitor Jarak Jauh atas radio tersebut, dll. Respons yang benar ditentukan oleh organisasi Anda dan situasi individu.

Mengabaikan Panggilan Balik Darurat

Penyempurnaan fitur ini ditujukan untuk memberikan opsi agar radio dapat mengabaikan Panggilan Balik Darurat aktif.

Untuk mengaktifkan Abaikan Panggilan Balik Darurat, radio harus dikonfigurasi di Perangkat Lunak Pemrograman Pelanggan Connect Plus (CPCPS).

Apabila fitur ini diaktifkan, radio tidak menampilkan indikasi Panggilan Darurat dan tidak menerima audio apa pun pada ID Grup Balik Darurat default.

Tanyakan kepada penyalur atau administrator sistem Anda untuk informasi lebih lanjut.

Memulai Panggilan Darurat



PEMBERITAHUAN:

Jika radio Anda diatur ke Senyap, radio tidak menyediakan indikator audio atau visual selama mode Darurat hingga Anda menekan tombol **PTT** untuk memulai transmisi suara.

Jika radio Anda diatur ke Senyap dengan Suara, radio awalnya tidak menyediakan indikator audio atau visual bahwa radio berada dalam mode Darurat. Namun, radio Anda bersuara lagi untuk transmisi radio sesuai keadaan darurat Anda.

Indikator darurat hanya muncul setelah Anda menekan tombol **PTT** untuk memulai transmisi suara dari radio Anda.

Untuk operasi “Senyap” maupun “Senyap dengan Suara”, radio secara otomatis keluar dari operasi senyap setelah Panggilan Darurat selesai.

- 1 Tekan tombol **Darurat** yang terprogram.
-
- 2 Tekan tombol **PTT** untuk memulai transmisi suara pada grup Darurat.
Ketika Anda melepaskan tombol **PTT**, panggilan Darurat akan berlanjut selama jangka waktu yang dialokasikan untuk Waktu Hang Panggilan Darurat.

Jika Anda menekan tombol **PTT** selama waktu ini, panggilan Darurat akan berlanjut.

Memulai Panggilan Darurat dengan Suara untuk Diikuti

Radio Anda harus diprogram untuk jenis operasi ini.

Bila diaktifkan untuk operasi ini, ketika Anda menekan tombol **Darurat** yang sudah diprogram, dan ketika radio Anda menerima penetapan slot waktu, mikrofon akan diaktifkan secara otomatis tanpa menekan tombol **PTT**. Status mikrofon yang diaktifkan ini juga disebut sebagai "mikrofon aktif". "Hot mic" ini berlaku pada transmisi suara pertama dari radio Anda selama panggilan Darurat. Untuk transmisi berikutnya dalam panggilan Darurat yang sama, Anda harus menekan tombol **PTT**.

- 1 Tekan tombol **Darurat** yang terprogram.
 - 2 Mikrofon tetap aktif selama waktu "hot mic" yang ditentukan dalam Pemrograman codeplug radio.
Selama waktu ini, LED akan menyala hijau.
-

- 3 Tekan dan tahan tombol **PTT** untuk berbicara lebih lama daripada durasi terprogram.
-

Memulai Peringatan Darurat



PEMBERITAHUAN:

Jika radio Anda diprogram untuk "Senyap" atau "Senyap dengan Suara", radio ini tidak akan menyediakan indikasi audio atau visual bahwa ia mengirimkan Peringatan Darurat. Jika diprogram untuk "Senyap", operasi senyap akan berlanjut tanpa batas waktu hingga Anda menekan tombol PTT atau tombol yang dikonfigurasi untuk "Darurat Nonaktif". Jika diprogram untuk "Senyap dengan Suara", radio otomatis akan membatalkan operasi senyap ketika pengontrol site menyiarkan Peringatan Darurat.

Tekan tombol **Darurat** berwarna jingga.

Saat mengirimkan transmisi Peringatan Darurat ke pengontrol site, layar radio menampilkan ikon

Darurat, kontak Grup yang digunakan untuk Peringatan Darurat, dan Alarm TX.

Setelah Peringatan Darurat berhasil dikirim dan sedang disiarkan untuk didengarkan radio lain, nada indikator positif akan berbunyi dan layar radio menampilkan Alarm Terkirim. Jika Peringatan Darurat tidak berhasil, nada indikator negatif berbunyi dan radio menampilkan Alarm Gagal.

Keluar dari Mode Darurat



PEMBERITAHUAN:

Jika panggilan Darurat berakhir karena habisnya Waktu Hang Darurat, tetapi kondisi darurat belum usai, tekan tombol **Darurat** lagi untuk memulai ulang prosesnya.

Jika Anda memulai Peringatan Darurat dengan menekan tombol **Darurat** terprogram, radio Anda akan keluar dari mode Darurat secara otomatis setelah menerima respons dari sistem Connect Plus.

Jika Anda memulai panggilan **Darurat** dengan menekan tombol Darurat, radio Anda otomatis akan ditetapkan sebagai saluran bila saluran ini tersedia. Setelah radio Anda mengirimkan pesan yang menunjukkan keadaan

darurat, Anda tidak dapat membatalkan panggilan Darurat Anda. Namun, jika Anda menekan tombol ini secara tak sengaja atau keadaan darurat tidak ada lagi, Anda mungkin ingin mengucapkan hal ini melalui saluran yang ditetapkan. Ketika Anda melepaskan tombol **PTT**, panggilan Darurat akan dihentikan setelah Waktu Hang Panggilan Darurat berakhir.

Jika radio Anda dikonfigurasi untuk Keadaan Darurat dengan Suara untuk Diikuti, gunakan periode “hot mic” untuk menjelaskan kesalahan Anda, kemudian tekan dan lepaskan tombol **PTT** untuk menghentikan transmisi. Panggilan Darurat akan dihentikan setelah Waktu Hang Panggilan Darurat berakhir.

Pengolahan Pesan Teks

Radio Anda mampu menerima data, misalnya pesan teks, dari radio lain atau aplikasi pesan teks.

Ada dua jenis pesan teks, Pesan Teks Singkat Radio Mobile Digital (DMR) dan pesan teks. Panjang maksimal Pesan Teks Singkat DMR adalah 23 karakter. Panjang maksimum pesan teks adalah 280 karakter, termasuk baris subjek. Baris subjek hanya muncul saat Anda menerima pesan dari aplikasi email.



PEMBERITAHUAN:







Panjang karakter maksimum hanya berlaku untuk model dengan perangkat lunak dan perangkat keras terbaru. Untuk model radio dengan perangkat lunak dan perangkat keras lama, panjang maksimum pesan teks adalah 140 karakter. Tanyakan kepada penyalur atau administrator sistem Anda untuk informasi lebih lanjut.

Mengirimkan Pesan Teks Cepat

Radio Anda mendukung maksimal 10 pesan Teks Cepat yang telah diprogram oleh dealer.

Meskipun isi pesan Teks Cepat telah ditentukan sebelumnya, Anda dapat mengedit setiap pesan sebelum mengirimnya.

Jika Anda mengirimkan pesan, lakukan berikut untuk memilih penerima:

- Tekan  atau  ke alias yang diinginkan dan tekan  untuk memilih.
- Tekan  atau  ke Panggilan Manual, dan tekan  untuk memilih. Baris pertama

layar menampilkan Nomor: . Baris kedua layar menampilkan kursor yang berkedip. Masukkan

alias atau ID subscriber, lalu tekan  .

Layar akan menampilkan Mengirim Pesan, yang mengonfirmasikan bahwa pesan Anda sedang dikirim.

Jika pesan berhasil dikirim, nada akan berbunyi dan layar akan menampilkan Pesan Terkirim.

Jika pesan tidak dapat dikirim, sebuah nada rendah akan berbunyi dan layar akan menampilkan Kirim Pesan Gagal.

Jika pesan teks gagal terkirim, radio mengembalikan Anda ke layar opsi Kirim Ulang (lihat [Mengelola Pesan Teks yang Gagal Terkirim di halaman 295](#)).

Mengirimkan Pesan Teks Cepat dengan Tombol Akses Satu Sentuhan

Anda dapat mengirimkan Pesan Teks Cepat menggunakan tombol dapat diprogram yang telah diprogram oleh dealer.

Tekan tombol **Akses Satu Sentuhan** yang diprogram untuk mengirim Teks Cepat yang telah ditentukan ke alias yang telah ditentukan.

Layar akan menampilkan Mengirim Pesan, yang mengonfirmasikan bahwa pesan Anda sedang dikirim.

Jika pesan berhasil dikirim, sebuah nada berbunyi dan layar menampilkan Pesan Terkirim.

Jika pesan tidak dapat dikirim, sebuah nada rendah berbunyi dan layar menampilkan Kirim Pesan Gagal.

Jika pesan teks gagal terkirim, radio mengembalikan Anda ke layar opsi Kirim Ulang (lihat [Mengelola Pesan Teks yang Gagal Terkirim di halaman 295](#)).

Mengakses Folder Konsep

Folder Draf menyimpan maksimum sepuluh (10) pesan terakhir yang disimpan. Saat folder penuh, pesan SMS yang berikutnya disimpan akan otomatis menggantikan pesan SMS terlama dalam folder.







PEMBERITAHUAN:



Anda dapat mengedit pesan teks yang disimpan sebelum mengirimnya. Hanya tersedia dengan mikrofon keypad (lihat [Mengedit dan Mengirim Pesan Teks yang Disimpan di halaman 294](#)). Untuk kembali ke layar Awal, tekan lama  kapan saja.

Melihat Pesan Teks yang Disimpan

1 Akses fitur Pesan Teks.



Kontrol Radio	Langkah
Tombol Pesan Teks terprogram	Tekan tombol Pesan Teks terprogram.
Menu	<p>a Tekan  untuk mengakses menu.</p> <p>b Tekan  atau  ke Pesan dan tekan  untuk memilih.</p>

2 Tekan  atau  ke Konsep dan tekan  untuk memilih.





3 Tekan  atau  ke pesan yang diinginkan dan tekan  untuk memilih.

Mengedit dan Mengirim Pesan Teks yang Disimpan

1 Tekan  lagi saat melihat pesan.

2 Tekan  atau  ke Edit dan tekan  untuk memilih.
Kursor berkedip akan ditampilkan.







3 Gunakan keypad untuk mengetik pesan.

Tekan  untuk bergerak satu spasi ke kiri. Tekan tombol  atau  untuk bergerak satu spasi ke kanan. Tekan  untuk menghapus karakter yang

tidak diinginkan. Tekan lama  untuk mengganti metode entri teks.

4 Tekan  setelah selesai membuat pesan.

5 Pilih penerima pesan berdasarkan:

- Tekan  atau  ke alias yang diinginkan dan tekan  untuk memilih.
- Tekan  atau  ke Panggilan Manual, dan tekan  untuk memilih. Baris pertama layar menampilkan Nomor:. Baris kedua layar menampilkan kursor yang berkedip. Masukkan alias atau ID subscriber, lalu tekan  .

Layar akan menampilkan Mengirim Pesan, yang mengonfirmasikan bahwa pesan Anda sedang dikirim.

Jika pesan berhasil dikirim, nada akan berbunyi dan layar akan menampilkan Pesan Terkirim.



Jika pesan tidak dapat dikirim, sebuah nada rendah akan berbunyi dan layar akan menampilkan Kirim Pesan Gagal.

Jika pesan teks gagal dikirim, pesan tersebut akan dipindahkan ke folder Item Terkirim dan ditandai dengan ikon Gagal Terkirim.

Menghapus Pesan Teks yang Disimpan dari Konsep

1 Akses fitur **Pesan Teks**.

Kontrol Radio	Langkah
Tombol Pesan Teks terprogram	Tekan tombol Pesan Teks terprogram.
Menu	a Tekan  untuk mengakses menu.

Kontrol Radio	Langkah
	b Tekan  atau  ke Pesan dan tekan  untuk memilih.

2 Tekan  atau  ke Konsep dan tekan  untuk memilih.

3 Tekan  atau  ke pesan yang diinginkan dan tekan  untuk memilih.

4 Tekan  atau  ke Hapus dan tekan  untuk menghapus pesan teks.

Mengelola Pesan Teks yang Gagal Terkirim

Anda bisa memilih salah satu dari opsi berikut ini ketika berada di layar opsi *Resend* (Kirim Ulang):

- *Resend* (Kirim Ulang)

- Putar Maju
- Edit

Mengirim Ulang Pesan Teks

Tekan  untuk mengirimkan ulang pesan yang sama ke subscriber/alias grup atau ID yang sama.



Jika pesan berhasil dikirim, nada akan berbunyi dan layar menampilkan pemberitahuan mini positif.

Jika pesan berhasil dikirim, nada akan berbunyi dan layar menampilkan pemberitahuan mini negatif.

Meneruskan Pesan Teks

Pilih **Teruskan** untuk mengirimkan pesan ke alias atau ID subscriber/grup yang lain.

- 1 Tekan  atau  ke **Teruskan** dan tekan  untuk memilih.

- 2 Untuk memilih penerima pesan, tekan  atau  ke alias atau ID yang diinginkan dan tekan  untuk memilih.

Layar akan menampilkan **Mengirim Pesan**, yang mengonfirmasikan bahwa pesan Anda sedang dikirim.

Jika pesan berhasil dikirim, nada akan berbunyi dan layar akan menampilkan **Pesan Terkirim**.

Jika pesan tidak dapat dikirim, sebuah nada rendah akan berbunyi dan layar akan menampilkan **Kirim Pesan Gagal**.

Mengelola Pesan Teks Terkirim

Setelah pesan dikirimkan ke radio lain, pesan akan disimpan di **Item Terkirim**. Pesan teks terkirim terbaru selalu ditambahkan ke bagian teratas daftar **Item Terkirim**.





Folder **Item Terkirim** mampu menyimpan maksimal 30 pesan terakhir yang terkirim. Ketika folder penuh, pesan teks terkirim berikutnya akan otomatis menggantikan pesan teks terlama di folder itu.

**PEMBERITAHUAN:**

Untuk kembali ke layar Awal, tekan lama  kapan saja.

Melihat Pesan Teks Terkirim

1 Akses fitur **Pesan Teks**.

Kontrol Radio	Langkah
Tombol Pesan Teks terprogram	Tekan tombol Pesan Teks terprogram.
Menu	<p>a Tekan  untuk mengakses menu.</p> <p>b Tekan  atau  ke Pesan dan tekan  untuk memilih.</p>

2 Tekan  atau  ke **Item Terkirim** dan tekan  untuk memilih.

3 Tekan  atau  ke pesan yang diperlukan dan tekan  untuk memilih.



Ikon di sudut kanan atas layar menunjukkan status pesan (lihat [Ikon Item Terkirim di halaman 238](#)).

Mengirimkan Pesan Teks Terkirim

Anda dapat memilih salah satu dari opsi berikut ini ketika melihat pesan teks terkirim:

- Kirim Ulang
- Putar Maju
- Edit
- Hapus

1 Tekan  lagi saat melihat pesan.

- 2  atau  tekan  untuk memilih ke salah satu dari opsi berikut ini dan .

Opsi	Langkah
Putar Maju	Pilih Teruskan untuk mengirimkan pesan teks terpilih ke alias atau ID subscriber/grup lain (lihat Meneruskan Pesan Teks di halaman 296).
Hapus	Pilih Hapus untuk menghapus pesan teks.
Kirim Ulang	<p>Pilih Kirim Ulang untuk mengirimkan pesan teks yang dipilih ke alias atau ID subscriber/grup yang sama.</p> <p>Layar akan menampilkan Mengirim Pesan, yang mengonfirmasikan bahwa pesan yang sama sedang dikirim ke radio target yang sama.</p> <p>Jika pesan berhasil dikirim, nada akan berbunyi dan layar akan menampilkan Pesan Terkirim.</p>

Opsi	Langkah
	<p>Jika pesan tidak dapat dikirim, sebuah nada rendah akan berbunyi dan layar akan menampilkan Kirim Pesan Gagal.</p> <p>Jika pesan teks gagal terkirim, radio mengembalikan Anda ke layar opsi Kirim Ulang. Tekan  untuk mengirim ulang pesan ke alias atau ID subscriber/grup yang sama.</p>

Jika Anda keluar dari layar pengiriman pesan teks ketika pesan sedang dikirimkan, radio memperbarui status pesan dalam folder Item Terkirim tanpa indikasi audio atau visual apa pun.





Jika radio berganti mode atau mati sebelum status pesan di Item Terkirim diperbarui, radio tidak akan dapat menyelesaikan pesan Dalam Proses apa pun dan otomatis menandainya dengan ikon **Gagal Terkirim**.

Radio mendukung maksimal lima pesan Sedang Berlangsung dalam satu waktu. Selama periode ini, radio tidak dapat mengirimkan pesan baru apa pun

dan otomatis menandainya dengan ikon **Gagal Terkirim**.



Menghapus Semua Pesan Teks Terkirim dari Item Terkirim

1 Akses fitur **Pesan Teks**.







Kontrol Radio	Langkah
Tombol Pesan Teks terprogram	Tekan tombol Pesan Teks terprogram.
Menu	<p>a Tekan  untuk mengakses menu.</p> <p>b Tekan  atau  ke Pesan dan tekan  untuk memilih.</p>

2 Tekan  atau  ke Item Terkirim dan tekan  untuk memilih.

Jika Anda memilih Item Terkirim yang tidak memiliki pesan teks, layar akan menampilkan Daftar Kosong, dan nada rendah akan berbunyi jika Nada Keypad diaktifkan.

3 Tekan  atau  ke Hapus Semua dan tekan  untuk memilih.

4 Lakukan salah satu hal berikut.

- Tekan  atau  ke Ya dan tekan  untuk memilih. Layar menampilkan pemberitahuan mini positif.
- Tekan  atau  ke Tidak dan tekan  untuk kembali ke layar sebelumnya.

Menerima Pesan Teks

Ketika radio Anda menerima pesan, layar menampilkan Daftar Notifikasi dengan alias atau ID pengirim dan ikon Pesan.

Anda bisa memilih salah satu dari opsi berikut ini ketika menerima pesan teks:

- Baca
- Baca Nanti
- Hapus

Membaca Pesan Teks

- 1 Tekan  atau  ke Baca? dan tekan  untuk memilih.

Pesan yang dipilih di Kotak Masuk terbuka.

- 2 Lakukan salah satu langkah berikut:

- Tekan  untuk kembali ke Kotak Masuk.

- Tekan  sekali lagi untuk membalas, meneruskan, atau menghapus pesan teks.
-

Mengelola Pesan Teks yang Diterima

Gunakan Kotak Masuk untuk mengelola pesan teks Anda. Kotak Masuk dapat menyimpan maksimal 30 pesan.

Pesan Teks di Kotak Masuk diurutkan menurut yang paling baru dibaca.

Radio Anda mendukung opsi berikutnya untuk pesan teks:

- Balas (melalui Teks Cepat)
- Putar Maju
- Hapus
- Hapus Semua







PEMBERITAHUAN:



Jika jenis saluran tidak cocok, Anda hanya dapat meneruskan, menghapus, atau menghapus semua pesan yang Diterima.



Untuk kembali ke layar Awal, tekan lama  kapan saja.



Melihat Pesan Teks dari Kotak Masuk

- 1 Tekan  untuk mengakses menu.

- 2 Tekan  atau  ke Pesan dan tekan  untuk memilih.





- 3 Tekan  atau  ke Kotak Masuk dan tekan  untuk memilih.

- 4 Tekan  atau  untuk melihat pesan.

- 5 Lakukan salah satu langkah berikut:
 - Tekan  untuk memilih pesan saat ini, dan tekan  lagi untuk membalas, meneruskan, atau menghapus pesan tersebut.
 - Tekan lama  untuk kembali ke layar Awal.

Membalas Pesan Teks dari Kotak Masuk

- 1 Akses fitur **Pesan Teks**.

Kontrol Radio	Langkah
Tombol Pesan Teks terprogram	Tekan tombol Pesan Teks terprogram.
Menu	<ol style="list-style-type: none"> a Tekan  untuk mengakses menu. b Tekan  atau  ke Pesan dan tekan  untuk memilih.

- 2 Tekan  atau  ke Kotak Masuk dan tekan  untuk memilih.

3 Tekan  atau  ke pesan yang diinginkan dan tekan  untuk memilih.

4 Tekan  sekali lagi untuk mengakses submenu.

5 Gunakan keypad untuk menulis/mengedit pesan Anda.

6 Tekan  setelah selesai membuat pesan.

Layar akan menampilkan Mengirim Pesan, yang mengonfirmasikan bahwa pesan Anda sedang dikirim.





Jika pesan berhasil dikirim, nada akan berbunyi dan layar akan menampilkan Pesan Terkirim.

Jika pesan tidak dapat dikirim, sebuah nada rendah akan berbunyi dan layar akan menampilkan Kirim Pesan Gagal.

Jika pesan teks tidak terkirim, radio mengembalikan Anda ke layar opsi Kirim Ulang (lihat [Mengelola Pesan Teks yang Gagal Terkirim di halaman 295](#)).

Menghapus Pesan Teks dari Kotak Masuk

1 Akses fitur **Pesan Teks**.

Kontrol Radio	Langkah
Tombol Pesan Teks terprogram	Tekan tombol Pesan Teks terprogram.
Menu	<p>a Tekan  untuk mengakses menu.</p> <p>b Tekan  atau  ke Pesan dan tekan  untuk memilih.</p>

2 Tekan  atau  ke Kotak Masuk dan tekan  untuk memilih.

3 Tekan  atau  ke pesan yang diinginkan dan tekan  untuk memilih.

4 Tekan  sekali lagi untuk mengakses submenu.

5 Tekan  atau  ke Hapus dan tekan  untuk memilih.





6 Tekan  atau  ke Ya dan tekan  untuk memilih.

Layar menampilkan Pesan Dihapus, dan layar kembali ke Kotak Masuk.

Menghapus Semua Pesan Teks dari Kotak Masuk

1 Akses fitur **Pesan Teks**.

Kontrol Radio	Langkah
Tombol Pesan Teks terprogram	Tekan tombol Pesan Teks terprogram.

Kontrol Radio	Langkah
Menu	<p>a Tekan  untuk mengakses menu.</p> <p>b Tekan  atau  ke Pesan dan tekan  untuk memilih.</p>

2 Tekan  atau  ke Kotak Masuk dan tekan  untuk memilih.

Bila Anda memilih Kotak Masuk yang tidak memiliki pesan teks, Daftar Kosong akan ditampilkan di layar dan nada rendah akan berbunyi jika Nada Keypad diaktifkan (lihat [Mengaktifkan atau Menonaktifkan Nada Keypad di halaman 209](#)).

3 Tekan  atau  ke Hapus Semua dan tekan  untuk memilih.

- 4 Tekan  atau  ke Ya dan tekan  untuk memilih.

Layar akan menampilkan Kotak Masuk Dibersihkan.

Privasi

Jika diaktifkan, fitur ini membantu mencegah pengguna yang tidak sah menguping pada saluran dengan menggunakan solusi pengacakan berbasis perangkat lunak. Transmisi pengiriman sinyal dan identifikasi pengguna tidak diacak.

Privasi pada radio Anda harus diaktifkan pada posisi pilih saluran saat ini untuk mengirim transmisi dengan privasi diaktifkan, meskipun ini bukan persyaratan yang perlu untuk menerima transmisi. Ketika berada pada posisi pilih saluran dengan privasi diaktifkan, radio masih bisa menerima transmisi (tidak diacak) dengan jelas.

Radio Anda mendukung Privasi yang Disempurnakan.

Untuk menguraikan transmisi panggilan dengan privasi diaktifkan, radio Anda harus diprogram agar mempunyai Nilai Kunci dan ID Kunci (untuk Privasi yang

Disempurnakan) yang sama dengan radio yang mengirim transmisi.

Jika radio Anda menerima panggilan diacak yang berasal dari Nilai Kunci dan ID Kunci yang berbeda, Anda tidak akan mendengar apa pun (Privasi yang Disempurnakan).

Jika salah satu jenis privasi ditetapkan pada radio, ikon aman atau tidak aman akan tampil di layar Awal, kecuali saat radio sedang mengirim atau menerima Panggilan darurat atau alarm.

Lampu LED menyala hijau terus ketika radio bertransmisi dan berkedip hijau dengan cepat apabila radio menerima transmisi keluar dengan privasi diaktifkan.



Anda dapat mengakses fitur ini dengan melakukan salah satu dari tindakan berikut ini:





- Tekan tombol terprogram **Privasi** untuk mengaktifkan atau menonaktifkan privasi.
- Menggunakan Menu Radio sebagaimana digambarkan oleh langkah-langkah yang dijelaskan berikut.



**PEMBERITAHUAN:**

Beberapa model radio mungkin tidak menawarkan fitur Privasi ini. Tanyakan kepada penyalur atau administrator sistem Anda untuk informasi lebih lanjut.

- 1 Tekan  untuk mengakses menu.

- 2 Tekan  atau  ke `Utilitas` dan tekan  untuk memilih.

- 3 Tekan  atau  ke `Pengaturan Radio` atau  atau  ke `Connect Plus` dan tekan  untuk memilih.

- 4 Tekan  atau  ke `Privasi yang Disempurnakan`.

Jika layar menampilkan `Hidupkan`, tekan  untuk mengaktifkan Privasi. Radio menampilkan pesan yang mengonfirmasi pilihan Anda.

Jika layar menampilkan `Matikan`, tekan  untuk menonaktifkan Privasi. Radio menampilkan pesan yang mengonfirmasi pilihan Anda.

Jika radio menetapkan salah satu jenis privasi, ikon aman atau tidak aman akan tampil di panel status, kecuali saat radio sedang mengirim atau menerima Panggilan darurat atau alarm.

Melakukan Panggilan dengan Privasi Diaktifkan (Acak)

Aktifkan privasi menggunakan tombol privasi yang diprogram atau menggunakan menu. Radio Anda harus memiliki fitur Privasi yang diaktifkan untuk posisi saluran yang saat ini terpilih guna mengirim transmisi dengan privasi diaktifkan. Saat privasi diaktifkan untuk posisi saluran yang saat ini terpilih, semua transmisi suara yang dilakukan radio Anda akan diacak. Hal ini meliputi Panggilan Grup, Panggilan Multigrup, talk-back selama panggilan terpindai, Semua Panggilan Site, Panggilan Darurat, dan Panggilan Pribadi. Hanya radio penerima dengan Nilai Kunci dan ID Kunci yang sama dengan radio Anda yang akan dapat mengurai transmisi.

Dukungan

Anda bisa mengaktifkan atau menonaktifkan radio mana pun di sistem. Misalnya, Anda mungkin perlu menonaktifkan radio yang dicuri, untuk mencegah pencuri menggunakannya, dan mengaktifkan radio itu, ketika sudah kembali ke tangan Anda.









PEMBERITAHUAN:









Melakukan Penonaktifan dan Pengaktifan Radio terbatas pada radio yang sudah mengaktifkan fungsi ini. Tanyakan kepada penyalur atau administrator sistem Anda untuk informasi lebih lanjut.





Penonaktifan Radio

- 1 Anda dapat mengakses fitur ini dengan melakukan salah satu dari tindakan berikut:

Kontrol Radio	Langkah
Tombol Penonaktifan Radio	a Tekan tombol Penonaktifan Radio terprogram.

Kontrol Radio	Langkah
	<p>b Tekan  atau  ke alias atau ID yang diperlukan dan tekan  untuk memilih.</p>
Menu radio	<p>a Tekan  untuk mengakses menu.</p> <p>b Tekan  atau  ke Kontak dan tekan  untuk memilih. Entri diurutkan berdasar abjad.</p> <p>c Gunakan salah satu langkah yang digambarkan berikut untuk memilih alias atau ID subscriber yang diperlukan:</p> <ul style="list-style-type: none"> • Pilih alias atau ID yang diinginkan secara langsung.

Kontrol Radio	Langkah
	<ul style="list-style-type: none"> • Tekan  atau  ke alias atau ID yang diperlukan dan tekan  untuk memilih. • Gunakan menu Panggilan Manual. • Tekan  atau  ke Panggilan Manual dan tekan  untuk memilih. • Tekan  atau  ke Nomor Radio dan tekan  untuk memilih. • Baris pertama layar menampilkan Radio Number: (Nomor Radio:).

Kontrol Radio	Langkah
	<p>Baris kedua layar menampilkan kursor yang berkedip. Gunakan keypad untuk memasukkan alias atau ID subscriber dan tekan  .</p> <p>d Tekan  atau  ke Penonaktifan Radio dan tekan  untuk memilih.</p>

Layar menampilkan Penonaktifan Radio: <Alias atau ID Target> dan LED berkedip hijau.





2 Tunggu respons.

Jika berhasil, nada indikator positif akan berbunyi dan layar akan menampilkan Penonaktifan Radio Berhasil.

Jika tidak berhasil, nada indikator negatif akan berbunyi dan layar akan menampilkan pesan Penonaktifan Radio Gagal.







Pengaktifan Radio







- 1 Anda dapat mengakses fitur ini dengan melakukan salah satu dari tindakan berikut:





Kontrol Radio	Langkah
Tombol Pengaktifan Radio	<p>a Tekan tombol Pengaktifan Radio yang terprogram.</p> <p>b Tekan  atau  ke alias atau ID yang diperlukan dan tekan  untuk memilih.</p>
Menu radio	<p>a Tekan  untuk mengakses menu.</p>

Kontrol Radio

Langkah

- b** Tekan  atau  ke Kontak dan tekan  untuk memilih. Entri diurutkan berdasar abjad.
- c** Gunakan salah satu langkah yang digambarkan berikut untuk memilih alias atau ID subscriber yang diperlukan
- Pilih alias atau ID yang diinginkan secara langsung.
 - Tekan  atau  ke alias atau ID yang diperlukan dan tekan  untuk memilih.

Kontrol Radio	Langkah
	<ul style="list-style-type: none"> • Gunakan menu Panggilan Manual. • Tekan  atau  ke Panggilan Manual dan tekan  untuk memilih. • Tekan  atau  ke Nomor Radio dan tekan  untuk memilih. • Baris pertama layar menampilkan Radio Number: (Nomor Radio:). Baris kedua layar menampilkan kursor yang berkedip.

Kontrol Radio	Langkah
	<p>Gunakan keypad untuk memasukkan alias atau ID subscriber dan tekan .</p> <p>d Tekan  atau  ke Pengaktifan Radio dan tekan  untuk memilih.</p>

Layar menampilkan Pengaktifan Radio: <Alias atau ID Subscriber> dan LED hijau menyala terus-menerus.

2 Tunggu respons.

Jika berhasil, sebuah nada indikator positif akan berbunyi dan layar akan menampilkan Pengaktifan Radio Berhasil.

Jika tidak berhasil, sebuah nada indikator negatif akan berbunyi dan layar akan menampilkan Pengaktifan Radio Gagal.

Pengoperasian Bluetooth



PEMBERITAHUAN:

Jika dinonaktifkan via CPS, semua fitur terkait Bluetooth akan dinonaktifkan dan database perangkat Bluetooth dihapus.

Fitur ini memungkinkan Anda menggunakan radio dengan perangkat yang mendukung Bluetooth (aksesori) melalui sambungan nirkabel Bluetooth. Radio mendukung perangkat Bluetooth dari Motorola Solutions dan COTS (Commercially available Off-The-Shelf).

Bluetooth beroperasi dalam jarak pandang sejauh 10 meter (32 kaki). Ini adalah jalur tanpa hambatan antara radio Anda dan perangkat berkemampuan Bluetooth.

Sebaiknya jangan tinggalkan radio Anda dan berharap perangkat berkemampuan Bluetooth Anda berfungsi dengan sangat andal ketika terpisah jauh.

Di area batas penerimaan, kualitas suara dan nada akan mulai terdengar "samar" atau "terputus-putus". Untuk



mengatasi masalah ini, letakkan radio dan perangkat yang mendukung Bluetooth lebih berdekatan (dalam rentang 10 meter/32 kaki yang telah dijelaskan) untuk mendapatkan kembali penerimaan audio yang jernih. Fungsi Bluetooth radio memiliki daya maksimum sebesar 2,5 mW (4 dBm) dalam jangkauan 10 meter/32 kaki.



Radio dapat mendukung maksimum 4 sambungan Bluetooth secara bersamaan dengan perangkat Bluetooth dari jenis yang berbeda. Misalnya, headset, dan POD (PTT-Only Device). Beberapa sambungan dengan jenis perangkat berkemampuan Bluetooth dari tipe yang sama tidak didukung.

Lihat panduan pengguna perangkat berkemampuan Bluetooth terkait untuk detail lebih lanjut tentang kapabilitas perangkat berkemampuan Bluetooth Anda secara lengkap.

Mengaktifkan dan Menonaktifkan Bluetooth









- 1 Tekan  untuk mengakses menu.
-

2 Tekan  atau  ke Bluetooth dan tekan  untuk memilih.

3 Tekan  atau  ke Status Saya dan tekan  untuk memilih.

Layar akan menampilkan Aktif dan Nonaktif. Status saat ini ditunjukkan oleh .

4 Lakukan salah satu langkah berikut:

- Tekan  atau  ke Aktif dan tekan  untuk memilih. Layar menampilkan Aktif dan  muncul di sebelah kiri status terpilih.
 - Tekan  atau  ke Nonaktif dan tekan  untuk memilih. Layar menampilkan Nonaktif dan  muncul di sebelah kiri status terpilih.
-



Mencari dan Menyambung ke Perangkat Bluetooth



Jangan menonaktifkan perangkat dengan dukungan

Bluetooth atau menekan  saat pencarian dan operasi penyambungan berlangsung karena dapat membatalkan operasi.









- 1 Hidupkan perangkat berkemampuan Bluetooth dan alihkan ke mode pasangan. Lihat panduan pengguna untuk perangkat berkemampuan Bluetooth terkait.
-



2 Pada radio, tekan tombol  untuk mengakses menu.

3 Tekan  atau  ke Bluetooth dan tekan  untuk memilih.

4 Tekan  atau  ke Perangkat dan tekan  untuk memilih.

5 Lakukan salah satu langkah berikut:

- Tekan  atau  ke perangkat yang diinginkan dan tekan  untuk memilih.
- Tekan  atau  ke Cari Perangkat untuk mencari perangkat yang tersedia. Tekan  atau  ke perangkat yang diinginkan dan tekan  untuk memilih.

6 Tekan  atau  ke Hubungkan dan tekan  untuk memilih.

Layar menampilkan Menghubungkan ke <Perangkat>. Perangkat berkemampuan Bluetooth mungkin memerlukan langkah-langkah tambahan untuk menyelesaikan pemasangan. Lihat panduan pengguna untuk perangkat berkemampuan Bluetooth terkait.

Jika berhasil, layar radio menampilkan <Perangkat>Tersambung. Nada berbunyi dan  muncul di

sebelah perangkat yang tersambung. Ikon Bluetooth Tersambung akan ditampilkan di panel status.

Jika tidak berhasil, layar radio menampilkan Gagal Menghubungkan.



Mencari dan Menyambung dari Perangkat Bluetooth (Mode Dapat Ditemukan)

Jangan mematikan Bluetooth atau radio saat pencarian dan operasi penyambungan berlangsung karena dapat membatalkan operasi.

1 Aktifkan Bluetooth.

Lihat [Mengaktifkan dan Menonaktifkan Bluetooth di halaman 310](#).

2 Tekan  untuk mengakses menu.

3 Tekan  atau  ke Bluetooth dan tekan  untuk memilih.



- 4 Tekan  atau  ke **Temukan Saya** dan tekan  untuk memilih.

Sekarang radio dapat ditemukan oleh perangkat berkemampuan Bluetooth untuk durasi yang diprogram. Ini disebut Mode Dapat Ditemukan.

- 5 Hidupkan perangkat berkemampuan Bluetooth, lalu pasang dengan radio.
Lihat panduan pengguna untuk perangkat berkemampuan Bluetooth terkait.

Memutuskan Sambungan dari Perangkat Bluetooth

- 1 Pada radio, tekan  untuk mengakses menu.
- 2 Tekan  atau  ke **Bluetooth** dan tekan  untuk memilih.

- 3 Tekan  atau  ke **Perangkat** dan tekan  untuk memilih.

- 4 Tekan  atau  ke perangkat yang diinginkan dan tekan  untuk memilih.

- 5 Tekan  atau  ke **Putuskan Sambungan** dan tekan  untuk memilih.

Layar menampilkan **Memutuskan sambungan dari <Perangkat>**. Perangkat berkemampuan Bluetooth Anda mungkin memerlukan langkah tambahan untuk memutuskan sambungan. Lihat panduan pengguna untuk perangkat berkemampuan Bluetooth terkait.

Layar radio menampilkan **<Perangkat> Terputus**. Nada indikator positif akan berbunyi dan tanda  akan hilang dari samping perangkat yang tersambung. Ikon Bluetooth Tersambung akan hilang pada panel status.

Mengalihkan Rute Audio antara Speaker Radio Internal dan Perangkat Bluetooth



Anda bisa mengalihkan rute audio antara speaker radio internal dan eksternal pada aksesori berkemampuan Bluetooth.

Tekan tombol terprogram **Sakelar Audio Bluetooth**.

- Nada akan berbunyi dan layar menampilkan Arahkan Audio ke Radio.
- Nada akan berbunyi dan layar menampilkan Arahkan Audio ke Bluetooth.

Melihat Detail Perangkat

- 1 Tekan  untuk mengakses menu.
- 2 Tekan  atau  ke Bluetooth dan tekan  untuk memilih.



- 3 Tekan  atau  ke Perangkat dan tekan  untuk memilih.



- 4 Tekan  atau  ke perangkat yang diinginkan dan tekan  untuk memilih.

- 5 Tekan  atau  ke Lihat Detail dan tekan  untuk memilih.

Menghapus Nama Perangkat



Anda dapat menghapus perangkat yang diputus sambungannya dari daftar perangkat berkemampuan Bluetooth.

- 1 Tekan  untuk mengakses menu.
- 2 Tekan  atau  ke Bluetooth dan tekan  untuk memilih.

3 Tekan  atau  ke Perangkat dan tekan  untuk memilih.

4 Tekan  atau  ke perangkat yang diinginkan dan tekan  untuk memilih.

5 Tekan  atau  ke Hapus dan tekan  untuk memilih.
Layar menampilkan Perangkat Dihapus.

3 Tekan  atau  ke Penguatan Mik BT dan tekan  untuk memilih.

4 Tekan  atau  ke jenis Penguatan Mik BT dan nilai saat ini.



Untuk mengedit nilai, tekan  untuk memilih.

5 Tekan  atau  untuk menaikkan atau menurunkan nilai dan tekan  untuk memilih.

Penguatan Mikrofon Bluetooth

Memungkinkan kontrol pada nilai penguatan mikrofon dari perangkat berkemampuan Bluetooth.

1 Tekan  untuk mengakses menu.

2 Tekan  atau  ke Bluetooth dan tekan  untuk memilih.

Lokasi Dalam Ruangan



PEMBERITAHUAN:







Fitur Lokasi Dalam Ruangan hanya berlaku untuk model dengan perangkat lunak dan perangkat keras terbaru. Tanyakan kepada penyalur atau administrator sistem Anda untuk informasi lebih lanjut.

Lokasi Dalam Ruangan digunakan untuk terus melacak lokasi pengguna radio. Apabila Lokasi Dalam Ruangan diaktifkan, radio berada dalam mode dapat ditemukan

terbatas. Suar terdedikasi digunakan untuk menemukan lokasi radio dan menentukan posisinya.

Mengaktifkan atau Menonaktifkan Lokasi Dalam Ruangan

Anda dapat mengaktifkan atau menonaktifkan Lokasi Dalam Ruangan dengan melakukan satu tindakan berikut ini.

- Akses fitur ini melalui menu.
 - a. Tekan  untuk mengakses menu.
 - b. Tekan  atau  ke Bluetooth dan tekan  untuk memilih.
 - c. Tekan  atau  ke Lokasi Dalam Ruangan dan tekan  untuk memilih.

- d. Tekan  untuk mengaktifkan Lokasi Dalam Ruangan.

Layar menampilkan Lokasi Dalam Ruangan Aktif. Anda mendengarkan nada indikator positif.

Salah satu skenario berikut ini akan terjadi.

- Jika berhasil, ikon Lokasi Dalam Ruangan Tersedia akan muncul di tampilan layar Awal.
- Jika tidak berhasil, layar menampilkan Pengaktifan Gagal. Anda mendengarkan nada indikator negatif.

- e. Tekan  untuk menonaktifkan Lokasi Dalam Ruangan.

Layar menampilkan Lokasi Dalam Ruangan Nonaktif. Anda mendengarkan nada indikator positif.

Salah satu skenario berikut ini akan terjadi.

- Jika berhasil, ikon Lokasi Dalam Ruangan Tersedia akan hilang dari tampilan layar Awal.

- Jika tidak berhasil, layar menampilkan **Penonaktifan Gagal**. Anda mendengarkan nada indikator negatif.
- Akses fitur ini menggunakan tombol terprogram.
 - a. Tekan lama tombol **Lokasi Dalam Ruangan** terprogram untuk mengaktifkan Lokasi Dalam Ruangan.

Layar menampilkan **Lokasi Dalam Ruangan Aktif**. Anda mendengarkan nada indikator positif.

Salah satu skenario berikut ini akan terjadi.

- Jika berhasil, ikon **Lokasi Dalam Ruangan Tersedia** akan muncul di tampilan layar Awal.
 - Jika tidak berhasil, layar menampilkan **Pengaktifan Gagal**. Jika tidak berhasil, Anda akan mendengar nada indikator negatif.
- b. Tekan tombol **Lokasi Dalam Ruangan** terprogram untuk menonaktifkan Lokasi Dalam Ruangan.

Layar menampilkan **Lokasi Dalam Ruangan Nonaktif**. Anda mendengarkan nada indikator positif.



Salah satu skenario berikut ini akan terjadi.



- Jika berhasil, ikon **Lokasi Dalam Ruangan Tersedia** akan hilang dari tampilan layar Awal.
- Jika tidak berhasil, layar menampilkan **Penonaktifan Gagal**. Jika tidak berhasil, Anda akan mendengar nada indikator negatif.

Mengakses Informasi Suar Lokasi Dalam Ruangan

Ikuti prosedur untuk mengakses informasi suar Lokasi Dalam Ruangan.

- 1 Tekan  untuk mengakses menu.

- 2 Tekan  atau  ke Bluetooth dan tekan  untuk memilih.

- 3 Tekan  atau  ke Lokasi Dalam Ruangan dan tekan  untuk memilih.

- 4 Tekan  atau  ke Suar dan tekan  untuk memilih.

Layar menampilkan informasi suar.

Daftar Notifikasi

Radio Anda memiliki Daftar Notifikasi yang mengumpulkan semua kejadian "belum dibaca" Anda di saluran, seperti pesan teks yang belum dibaca, panggilan tak terjawab, dan peringatan panggilan.

Ikon Pemberitahuan muncul di bilah status ketika Daftar Notifikasi mencatat satu atau lebih kejadian.

Daftar ini mendukung maksimal 40 kejadian tak terbaca. Bila penuh, kejadian berikutnya otomatis menggantikan kejadian terlama.





PEMBERITAHUAN:

Setelah kejadian dibaca, kejadian dihapus dari Daftar Pemberitahuan.

Mengakses Daftar Pemberitahuan

Ikuti prosedur untuk mengakses daftar notifikasi.

- 1 Tekan  untuk mengakses menu.

- 2 Tekan  atau  ke Notifikasi dan tekan  untuk memilih.

- 3 Tekan  atau  ke aktivitas yang diinginkan dan tekan  untuk memilih.

Tekan lama  untuk kembali ke layar Awal.

Pengoperasian Wi-Fi

Fitur ini memungkinkan Anda mengatur dan terhubung ke jaringan Wi-Fi. Wi-Fi mendukung pembaruan untuk firmware, codeplug, dan sumber daya radio seperti paket bahasa dan pengumuman suara.



PEMBERITAHUAN:

Fitur ini hanya berlaku untuk XiR M8668i/CM7668i saja.

Wi-Fi® adalah merek dagang terdaftar dari Wi-Fi Alliance®.

Radio Anda mendukung WEP/WPA/WPA2-Personal dan jaringan Wi-Fi WPA/WPA2-Enterprise.

Jaringan Wi-Fi WEP/WPA/WPA2-Personal

Menggunakan otentikasi berbasis kunci (kata sandi) yang dibagikan sebelumnya.

Kunci yang dibagikan sebelumnya bisa dimasukkan menggunakan menu atau CPS/RM.

Jaringan Wi-Fi WPA/WPA2-Enterprise

Menggunakan otentikasi berbasis sertifikat.

Radio Anda harus dikonfigurasi terlebih dahulu dengan sertifikat.



PEMBERITAHUAN:

Tanyakan kepada dealer atau administrator sistem Anda untuk terhubung ke jaringan Wi-Fi WPA/WPA2-Enterprise.

Tombol terprogram **Wi-Fi Aktif** atau **Nonaktif** dialokasikan oleh penyalur atau administrator sistem Anda. Tanyakan kepada dealer atau administrator sistem Anda untuk mengetahui bagaimana radio Anda diprogram.

Pengumuman Suara untuk tombol terprogram **Wi-Fi Aktif** atau **Nonaktif** dapat disesuaikan melalui CPS sesuai dengan kebutuhan pengguna. Tanyakan kepada penyalur atau administrator sistem Anda untuk informasi lebih lanjut.









PEMBERITAHUAN:

Anda dapat mengaktifkan atau menonaktifkan Wi-Fi dari jarak jauh menggunakan radio supervisor (lihat [Mengaktifkan atau Menonaktifkan Wi-Fi Menggunakan Radio Supervisor](#)). Tanyakan kepada penyalur atau administrator sistem Anda untuk informasi lebih lanjut.

Mengaktifkan atau Menonaktifkan Wi-Fi

Ikuti prosedur untuk mengaktifkan dan menonaktifkan Wi-Fi.

- 1 Tekan tombol terprogram **Wi-Fi Aktif** atau **Nonaktif**. Pengumuman Suara berbunyi ketika Wi-Fi Diaktifkan atau Wi-Fi Dinonaktifkan.

- 2 Akses fitur ini menggunakan menu.
 - a Tekan  untuk mengakses menu.
 - b Tekan  atau  ke WiFi dan tekan  untuk memilih.
 - c Tekan  atau  ke WiFi Aktif dan tekan  untuk memilih.

- d Tekan  untuk mengaktifkan/menonaktifkan Wi-Fi.

Jika Wi-Fi diaktifkan, layar akan menampilkan ✓ di sebelah Diaktifkan.

Jika Wi-Fi dinonaktifkan, ✓ hilang dari sebelah Diaktifkan.

Mengaktifkan atau Menonaktifkan Wi-Fi dari Jarak Jauh Menggunakan Radio Khusus (Kontrol Individu)

Ikuti prosedur untuk mengaktifkan atau menonaktifkan Wi-Fi dari jarak jauh di Kontrol Individu (Satu ke Satu).



PEMBERITAHUAN:

Hanya radio dengan pengaturan CPS khusus yang mendukung fungsi ini, tanyakan kepada dealer atau administrator sistem Anda untuk informasi lebih lanjut.

- 1 Lakukan salah satu langkah berikut:
 - Tekan lama tombol yang dapat diprogram. Gunakan keypad untuk memasukkan ID, dan

tekan  untuk memilih. Lanjutkan ke [langkah 3](#).

- Tekan  untuk mengakses menu.

2 Tekan  atau  ke Kontak dan tekan  untuk memilih.

3 Tekan  atau  ke Kontrol WiFi dan tekan  untuk memilih.

4 Tekan  atau  untuk memilih Nyala atau Mati.

5 Tekan  untuk memilih.

Jika berhasil, layar menampilkan pemberitahuan mini positif.

Jika gagal, layar menampilkan pemberitahuan mini negatif.

Mengaktifkan atau Menonaktifkan Wi-Fi dari Jarak Jauh Menggunakan Radio Khusus (Kontrol Grup)



Ikuti prosedur untuk mengaktifkan atau menonaktifkan Wi-Fi dari jarak jauh di Kontrol Grup (Satu ke Banyak).







PEMBERITAHUAN:

Hanya radio dengan pengaturan CPS khusus yang mendukung fungsi ini, tanyakan kepada dealer atau administrator sistem Anda untuk informasi lebih lanjut.

- 1 Tekan  untuk mengakses menu.

- 2 Tekan  atau  ke Kontak dan tekan  untuk memilih.

- 3 Tekan  atau  untuk memilih alias atau ID subscriber yang diinginkan.

- 4 Tekan  atau  ke Kontrol WiFi dan tekan  untuk memilih.

- 5 Tekan  atau  untuk memilih Nyala atau Mati.

- 6 Tekan  untuk memilih.

Jika berhasil, layar menampilkan Berhasil Dikirim.

Jika gagal, layar menampilkan pemberitahuan mini negatif.

Menghubungkan ke Titik Akses Jaringan

Ketika Wi-Fi diaktifkan, radio memindai dan menyambung ke titik akses jaringan.



PEMBERITAHUAN:

Anda juga dapat menyambung ke titik akses jaringan menggunakan menu.

Titik akses jaringan Wi-Fi WPA-Enterprise telah dikonfigurasi sebelumnya. Tanyakan kepada dealer atau administrator sistem Anda untuk mengetahui bagaimana radio Anda diprogram.

- 1 Tekan  untuk mengakses menu.

2 Tekan  atau  ke WiFi dan tekan  untuk memilih.



3 Tekan  atau  ke Jaringan dan tekan  untuk memilih.

4 Tekan  atau  ke titik akses jaringan dan tekan  untuk memilih.



PEMBERITAHUAN:

Untuk Wi-Fi WPA-Enterprise, jika titik akses jaringan tidak dikonfigurasi sebelumnya, opsi **Hubungkan** tidak tersedia.

5 Tekan  atau  ke **Hubungkan** dan tekan  untuk memilih.

6 Untuk Wi-Fi WPA-Personal, masukkan kata sandi dan tekan  .

7 Untuk Wi-Fi WPA-Enterprise, kata sandi dikonfigurasi dengan RM.

Jika kata sandi yang dikonfigurasi sebelumnya benar, radio Anda otomatis akan terhubung ke titik akses jaringan yang dipilih.

Jika kata sandi yang dikonfigurasi sebelumnya salah, layar menampilkan **Otentikasi Gagal**, dan otomatis kembali ke menu sebelumnya.

Jika berhasil terhubung, radio menampilkan pemberitahuan dan titik akses jaringan disimpan ke dalam daftar profil.

Jika tidak berhasil terhubung, radio menampilkan layar pemberitahuan kegagalan sesaat dan otomatis kembali ke menu sebelumnya.

Memeriksa Status Koneksi Wi-Fi

Ikuti prosedur untuk memeriksa status Koneksi Wi-Fi.

Tekan tombol terprogram **Permintaan Status Wi-Fi** untuk mengetahui status koneksi menggunakan Pengumuman Suara. Pengumuman Suara berbunyi ketika Wi-Fi

Dinonaktifkan, Wi-Fi Diaktifkan, tetapi tidak untuk Tidak Ada Koneksi atau Wi-Fi Aktif dengan Koneksi.

- Layar menampilkan WiFi Nonaktif saat Wi-Fi nonaktif.
- Layar menampilkan WiFi Aktif, Tersambung saat radio tersambung ke jaringan.
- Layar menampilkan WiFi Aktif, Terputus saat Wi-Fi aktif tetapi radio tidak tersambung ke jaringan.

Pengumuman Suara untuk hasil kueri status Wi-Fi dapat dikustomisasi lewat CPS sesuai dengan kebutuhan pengguna. Tanyakan kepada penyalur atau administrator sistem Anda untuk informasi lebih lanjut.









PEMBERITAHUAN:

Tombol terprogram **Kueri Status Wi-Fi** dialokasikan oleh penyalur atau administrator sistem Anda. Tanyakan kepada dealer atau administrator sistem Anda untuk mengetahui bagaimana radio Anda diprogram.



Menyegarkan Daftar Jaringan

Ikuti prosedur berikut untuk menyegarkan daftar jaringan.

- Lakukan tindakan berikut ini untuk menyegarkan daftar jaringan melalui menu.
 - a. Tekan  OK untuk mengakses menu.
 - b. Tekan  atau  ke WiFi dan tekan  OK untuk memilih.
 - c. Tekan  atau  ke Jaringan dan tekan  OK untuk memilih.

Ketika Anda masuk ke menu Jaringan, radio menyegarkan daftar jaringan secara otomatis.

- Jika Anda sudah berada di menu Jaringan, lakukan tindakan berikut ini untuk menyegarkan daftar jaringan.

Tekan  atau  ke Segarkan dan tekan  untuk memilih.

Radio akan menyegarkan dan menampilkan daftar jaringan terbaru.

Menambahkan Jaringan







PEMBERITAHUAN:

Tugas ini tidak bisa diterapkan ke jaringan Wi-Fi WPA-Enterprise.

Jika jaringan yang dipilih tidak terdapat dalam daftar jaringan tersedia, lakukan tindakan berikut ini untuk menambahkan jaringan.

- 1 Tekan  untuk mengakses menu.
- 2 Tekan  atau  ke WiFi dan tekan  untuk memilih.
- 3 Tekan  atau  ke Jaringan dan tekan  untuk memilih.

4 Tekan  atau  ke Tambah Jaringan dan tekan  untuk memilih.

5 Masukkan Service Set Identifier (SSID) dan tekan  .

6 Tekan  atau  ke Buka dan tekan  untuk memilih.

7 Masukkan kata sandi dan tekan  .

Radio menampilkan pemberitahuan mini positif untuk menunjukkan bahwa jaringan berhasil disimpan.



Melihat Detail Titik Akses Jaringan

Anda bisa melihat detail titik akses jaringan.

- 1 Tekan  untuk mengakses menu.

2 Tekan  atau  ke WiFi dan tekan  untuk memilih.

3 Tekan  atau  ke Jaringan dan tekan  untuk memilih.

4 Tekan  atau  ke titik akses jaringan dan tekan  untuk memilih.

5 Tekan  atau  ke Lihat Detail dan tekan  untuk memilih.



PEMBERITAHUAN:

Wi-Fi WPA-Personal dan WPA-Enterprise menampilkan detail yang berbeda atas Titik Akses Jaringan.

Wi-Fi WPA-Personal

Untuk titik akses jaringan yang terhubung, radio Anda menampilkan Service Set Identifier (SSID), Security Mode, alamat Media Access Control (MAC), dan alamat Internet Protocol (IP).

Untuk titik akses jaringan yang tidak terhubung, radio Anda menampilkan SSID dan Security Mode.

Wi-Fi WPA-Enterprise

Untuk titik akses jaringan yang terhubung, radio Anda menampilkan SSID, Security Mode, Identity, Extended Authentication Protocol (EAP) Method, Phase 2 Authentication, Cert Name, alamat MAC, alamat IP, Gateway, DNS1, dan DNS2.

Untuk titik akses jaringan yang tidak terhubung, radio Anda menampilkan SSID, Security Mode, Identity, EAP Method, Phase 2 Authentication, dan Cert Name.

Menghapus Titik Akses Jaringan



PEMBERITAHUAN:

Tugas ini tidak bisa diterapkan ke jaringan Wi-Fi Enterprise.

Lakukan tindakan berikut ini untuk menghapus titik akses jaringan dari daftar profil.

1 Tekan  untuk mengakses menu.

2 Tekan  atau  ke WiFi dan tekan  untuk memilih.

3 Tekan  atau  ke Jaringan dan tekan  untuk memilih.

4 Tekan  atau  ke titik akses jaringan yang dipilih dan tekan  untuk memilih.

5 Tekan  atau  ke Hapus dan tekan  untuk memilih.

6 Tekan  atau  ke Ya dan tekan  untuk memilih.

Radio menampilkan pemberitahuan mini positif untuk menunjukkan bahwa titik akses jaringan yang dipilih berhasil dihapus.

Utilitas

Bab ini menjelaskan pengoperasian fungsi utilitas yang terdapat di radio Anda.



Mengaktifkan atau Menonaktifkan Nada/Peringatan Radio



Anda dapat mengaktifkan dan menonaktifkan semua nada dan peringatan radio (kecuali untuk nada peringatan Darurat masuk) jika dibutuhkan.



Tekan tombol **Semua Nada/Peringatan** terprogram untuk mengaktifkan atau menonaktifkan semua nada, atau ikuti prosedur yang dijelaskan selanjutnya untuk mengakses fitur ini melalui menu radio.



1 Tekan  untuk mengakses menu.

2 Tekan  atau  ke Utilitas dan tekan  untuk memilih.

3 Tekan  atau  ke Pengaturan Radio dan tekan  untuk memilih.

4 Tekan  atau  ke Nada/Peringatan dan tekan  untuk memilih.

5 Tekan  atau  ke Semua Nada dan tekan  untuk memilih.



6 Tekan  untuk mengaktifkan/menonaktifkan semua nada dan peringatan.
Layar menampilkan  di sebelah Diaktifkan.
Tanda  hilang dari sebelah Diaktifkan.

volume nada/pemberitahuan, yang memungkinkannya lebih tinggi atau lebih rendah dibandingkan volume suara.

1 Tekan  untuk mengakses menu.

2 Tekan  atau  ke Utilitas dan tekan  untuk memilih.

3 Tekan  atau  ke Pengaturan Radio dan tekan  untuk memilih.

4 Tekan  atau  ke Nada/Peringatan dan tekan  untuk memilih.



5 Tekan  atau  ke Offset Vol. dan tekan  untuk memilih.

Mengatur Tingkat Offset Volume Peringatan Nada

Anda dapat menyesuaikan tingkat Offset Volume Peringatan Nada jika dibutuhkan. Fitur ini menyesuaikan

- 6 Tekan  atau  ke nilai volume yang diperlukan.
Radio membunyikan nada umpan balik dengan masing-masing nilai volume yang terkait.
-



7 Lakukan salah satu langkah berikut:



- Tekan  untuk menyimpan nilai volume suara yang diperlukan.
 - Tekan  untuk keluar tanpa mengubah pengaturan offset volume saat ini.
-



Mengaktifkan atau Menonaktifkan Nada Izin Bicara

Anda bisa mengaktifkan dan menonaktifkan Nada Izin Bicara jika dibutuhkan.



- 1 Tekan  untuk mengakses menu.
-

- 2 Tekan  atau  ke *Utilitas* dan tekan  untuk memilih.
-

- 3 Tekan  atau  ke *Pengaturan Radio* dan tekan  untuk memilih.
-

- 4 Tekan  atau  ke *Nada/Peringatan* dan tekan  untuk memilih.
-

- 5 Tekan  atau  ke *Izin Bicara* dan tekan  untuk memilih.
-

- 6 Tekan  untuk mengaktifkan/menonaktifkan Nada Izin Bicara.
Layar menampilkan  di sebelah *Diaktifkan*.
Tanda  hilang dari sebelah *Diaktifkan*.
-

Mengaktifkan atau Menonaktifkan Nada Tanda Hidup Radio

Anda dapat mengaktifkan dan menonaktifkan Nada Tanda Hidup jika diperlukan.



- 1 Tekan  untuk mengakses menu.

- 2 Tekan  atau  ke *Utilitas* dan tekan  untuk memilih.

- 3 Tekan  atau  ke *Pengaturan Radio* dan tekan  untuk memilih.

- 4 Tekan  atau  ke *Nada/Peringatan* dan tekan  untuk memilih.

- 5 Tekan  atau  ke *Daya* dan tekan  untuk memilih.

- 6 Tekan  untuk mengaktifkan/menonaktifkan Nada Peringatan Penyalaan.
Layar menampilkan  di sebelah *Diaktifkan*.
Tanda  hilang dari sebelah *Diaktifkan*.

Mengatur Tingkat Daya



Anda dapat mengubah setelan daya radio ke tinggi atau rendah untuk setiap zona Connect Plus.



Tinggi memungkinkan komunikasi dengan site menara dalam mode Connect Plus yang berada dalam jarak yang cukup jauh dari Anda. Rendah memungkinkan komunikasi dengan site menara pada mode Connect Plus dalam jarak lebih dekat.

Tekan tombol **Tingkat Daya** terprogram untuk beralih antara tingkat daya transmisi tinggi dan rendah.





Ikuti prosedur yang dijelaskan berikut ini untuk mengakses fitur ini melalui menu radio.

- 1 Tekan  untuk mengakses menu.

2 Tekan  atau  ke **Utilitas** dan tekan  untuk memilih.

3 Tekan  atau  ke **Pengaturan Radio** dan tekan  untuk memilih.

4 Tekan  atau  ke **Daya** dan tekan  untuk memilih.



5 Tekan  atau  ke pengaturan yang diperlukan dan tekan  untuk memilih.
✓ muncul di samping setelan yang dipilih. Kapan saja, tekan lama  untuk kembali ke layar Awal. Layar kembali ke menu sebelumnya.



Mengubah Mode Tampilan



Anda dapat mengubah mode tampilan radio antara Siang atau Malam jika diperlukan. Hal ini akan memengaruhi palet warna pada layar.

1 Tekan  untuk mengakses menu.

2 Tekan  atau  ke **Utilitas** dan tekan  untuk memilih.

3 Tekan  atau  ke **Pengaturan Radio** dan tekan  untuk memilih.

4 Tekan  atau  ke **Layar** dan tekan  untuk memilih.
Layar menampilkan Mode Siang dan Mode Malam.

- 5 Tekan  atau  ke pengaturan yang diinginkan dan tekan  untuk mengaktifkan. ✓ muncul di sebelah pengaturan yang dipilih.
-







Menyesuaikan Kecerahan Layar

Anda dapat menyesuaikan kecerahan layar radio sesuai kebutuhan.









PEMBERITAHUAN:

Kecerahan layar tidak dapat disesuaikan bila Kecerahan Otomatis diaktifkan.

- 1 Tekan  untuk mengakses menu.
-
- 2 Tekan  atau  ke **Utilitas** dan tekan  untuk memilih.
-
- 3 Tekan  atau  ke **Pengaturan Radio** dan tekan  untuk memilih.
-

- 4 Tekan  atau  ke **Layar** dan tekan  untuk memilih.
-



- 5 Tekan  atau  ke **Kecerahan** dan tekan  untuk memilih.
Layar menampilkan bilah kemajuan.
-



- 6 Kurangi kecerahan layar dengan menekan  atau tambah kecerahan layar dengan menekan . Pilih dari pengaturan 1 sampai 8. Tekan  untuk mengonfirmasi entri Anda.
-



Mengaktifkan atau Menonaktifkan Layar Pengantar



Anda bisa mengaktifkan dan menonaktifkan Layar Pengantar jika dibutuhkan.



- 1 Tekan  untuk mengakses menu.
-

- 2 Tekan  atau  ke **Utilitas** dan tekan  untuk memilih.

- 3 Tekan  atau  ke **Pengaturan Radio** dan tekan  untuk memilih.

- 4 Tekan  atau  ke **Layar** dan tekan  untuk memilih.



- 5 Tekan  atau  ke **Layar Intro** dan tekan  untuk memilih.



- 6 Tekan  untuk mengaktifkan/menonaktifkan **Layar Intro**.
Layar menampilkan  di sebelah **Diaktifkan**.
Tanda  hilang dari sebelah **Diaktifkan**.



Bahasa





Anda bisa mengatur layar radio dengan bahasa yang diinginkan.

- 1 Tekan  untuk mengakses menu.

- 2 Tekan  atau  ke **Utilitas** dan tekan  untuk memilih.

- 3 Tekan  atau  ke **Pengaturan Radio** dan tekan  untuk memilih.



- 4 Tekan  atau  ke **Bahasa** dan tekan  untuk memilih.



- 5 Tekan  atau  ke bahasa yang diperlukan dan tekan  untuk mengaktifkan.  muncul di sebelah bahasa yang dipilih.



Mengaktifkan atau Menonaktifkan Indikator LED



Anda bisa mengaktifkan dan menonaktifkan Indikator LED jika dibutuhkan.

- 1 Tekan  untuk mengakses menu.

- 2 Tekan  atau  ke *Utilitas* dan tekan  untuk memilih.

- 3 Tekan  atau  ke *Pengaturan Radio* dan tekan  untuk memilih.

- 4 Tekan  atau  ke *Indikator LED* dan tekan  untuk memilih.



- 5 Tekan  untuk mengaktifkan/menonaktifkan Indikator LED.
Layar menampilkan  di sebelah *Diaktifkan*.



Tanda  hilang dari sebelah *Diaktifkan*.



Mengidentifikasi Jenis Kabel

Anda dapat memilih jenis kabel yang digunakan radio.

- 1 Tekan  untuk mengakses menu.

- 2 Tekan  atau  ke *Utilitas* dan tekan  untuk memilih.

- 3 Tekan  atau  ke *Pengaturan Radio* dan tekan  untuk memilih.

- 4 Tekan  atau  ke *Jenis Kabel* dan tekan  untuk memilih.

- 5 Jenis kabel saat ini akan ditandai dengan .



Pengumuman Suara

Fitur ini mengaktifkan radio untuk menunjukkan dengan suara Zona atau Saluran sekarang yang baru ditetapkan oleh pengguna, atau tekanan tombol yang bisa diprogram. Indikator audio dapat dikustomisasi menurut keperluan subscriber. Ini biasanya berguna ketika pengguna kesulitan untuk membaca informasi yang ditampilkan di layar.

1 Tekan  untuk mengakses menu.



2 Tekan  atau  ke **Utilitas** dan tekan  untuk memilih.

3 Tekan  atau  ke **Pengaturan Radio** dan tekan  untuk memilih.

4 Tekan  atau  ke **Pengumuman Suara** dan tekan  untuk memilih.

Anda juga bisa menggunakan atau untuk mengubah opsi yang dipilih.

5 Lakukan salah satu langkah berikut:



- Tekan  untuk mengaktifkan Pengumuman Suara. Layar menampilkan ✓ di sebelah **Diaktifkan**.
 - Tekan  untuk menonaktifkan Pengumuman Suara. Tanda ✓ hilang dari sebelah **Diaktifkan**.
-



Pencatat Waktu Menu



Atur jangka waktu radio Anda berada di menu sebelum otomatis beralih ke layar Awal.



1 Tekan  untuk mengakses menu.

2 Tekan  atau  ke **Utilitas** dan tekan  untuk memilih.

3 Tekan  atau  ke **Pengaturan Radio** dan tekan  untuk memilih.

- 4 Tekan  atau  ke Layar dan tekan  untuk memilih.

- 5 Tekan  atau  ke Pencatat Waktu Menu dan tekan  untuk memilih.

- 6 Tekan  atau  ke pengaturan yang diperlukan dan tekan  untuk memilih.

Mengaktifkan atau Menonaktifkan Klakson/Lampu

Fitur ini harus diinstal melalui konektor aksesoris belakang pada radio oleh dealer.



Radio dapat memberi tahu Anda bila ada panggilan masuk menggunakan fitur klakson dan lampu. Bila fitur diaktifkan, panggilan masuk akan membunyikan klakson dan menyalakan lampu kendaraan.

- 1 Lakukan salah satu langkah berikut:

- Tekan tombol **Klakson/Lampu** yang telah diprogram untuk mengaktifkan atau menonaktifkan fitur klakson dan lampu. Lompati langkah-langkah berikut ini.

- Tekan  untuk mengakses menu.
-

- 2 Tekan  atau  ke Utilitas dan tekan  untuk memilih.
-

- 3 Tekan  atau  ke Pengaturan Radio dan tekan  untuk memilih.
-

- 4 Tekan  atau  ke Klakson/Lampu dan tekan  untuk memilih.
-

- 5 Tekan  untuk mengaktifkan/menonaktifkan Horns/Lights.



Layar menampilkan  di sebelah Diaktifkan.



Tanda  hilang dari sebelah Diaktifkan.



Mengatur Preferensi Operasi Kenop Ganda



Radio Anda memiliki **Kenop Volume/Saluran** fungsi ganda. Menonaktifkan pilihan fungsi ganda akan mengatur kenop tersebut untuk berfungsi hanya sebagai Kenop Volume.

- 1  untuk mengakses menu.

- 2  atau  ke *Utilitas* dan tekan  untuk memilih.

- 3  atau  ke *Pengaturan Radio* dan tekan  untuk memilih.



- 4  atau  tekan  untuk memilih ke *Kenop Ganda* dan .



- 5 Layar akan menampilkan *Volume Saja* dan *Volume & Saluran*.  atau  tekan  untuk memilih ke pengaturan yang diinginkan dan .
 ✓ muncul di samping setelan yang dipilih.
 Layar kembali ke menu sebelumnya.



Mik Digital AGC (Mic AGC-D)

Fitur ini mengontrol penguatan mikrofon radio secara otomatis sewaktu bertransmisi di sistem digital. Fitur ini menekan audio yang keras atau mendorong audio yang lemah ke nilai yang telah diatur untuk memberikan tingkat audio yang konsisten.





- 1 Tekan  untuk mengakses menu.

- 2 Tekan  atau  ke *Utilitas* dan tekan  untuk memilih.

3 Tekan  atau  ke Pengaturan Radio dan tekan  untuk memilih.

4 Tekan  atau  ke Mic AGC-D dan tekan  untuk memilih.

5 Lakukan salah satu langkah berikut:











- Tekan  untuk mengaktifkan **Mic AGC-D** .
Layar menampilkan  di sebelah Diaktifkan .
- Tekan  untuk menonaktifkan **Mic AGC-D** .
Ikon  hilang dari sebelah Diaktifkan .

Audio Cerdas

Radio ini dapat menyesuaikan volume audio secara otomatis untuk mengatasi kebisingan di sekitar, termasuk semua sumber kebisingan stasioner dan nonstasioner. Ini

adalah fitur Hanya terima dan tidak memengaruhi audio Transmisi.

1 Tekan  untuk mengakses menu.

Kontrol Radio	Langkah
Menu	<p>a Tekan  untuk mengakses menu.</p> <p>b Tekan  atau  ke Pengaturan Radio dan tekan  untuk memilih.</p> <p>c Tekan  atau  ke Pengaturan Radio dan tekan  untuk memilih.</p> <p>d Tekan  atau  ke Audio Cerdas dan tekan  untuk memilih.</p>



Kontrol Langkah Radio





PEMBERITAHUAN:

Anda juga bisa menggunakan atau untuk mengubah opsi yang dipilih.

e Lakukan salah satu langkah berikut:



- Tekan  untuk mengaktifkan Audio Cerdas. Layar menampilkan ✓ di sebelah Diaktifkan.
- Tekan  untuk menonaktifkan Audio Cerdas. Tanda ✓ hilang dari sebelah Diaktifkan.

2 Tekan  atau  ke Utilitas dan tekan  untuk memilih.

3 Tekan  atau  ke Pengaturan Radio dan tekan  untuk memilih.

4 Tekan  atau  ke Audio Cerdas dan tekan  untuk memilih.

5 Lakukan salah satu langkah berikut:



- Tekan  untuk mengaktifkan Audio Cerdas. Layar menampilkan ✓ di sebelah Diaktifkan.
- Tekan  untuk menonaktifkan Audio Cerdas. Tanda ✓ hilang dari sebelah Diaktifkan.



Lihat [Daftar Aksesori Resmi](#) untuk aksesori audio yang mendukung Bluetooth dengan Kontrol Volume Suara Otomatis internal untuk kinerja serupa.



Mengaktifkan atau Menonaktifkan Fitur Peredam Umpan Balik Akustik

Fitur ini membuat Anda dapat meminimalkan umpan balik akustik di panggilan yang diterima.





- 1 Tekan  untuk mengakses menu.

- 2 Tekan  atau  ke *Utilitas* dan tekan  untuk memilih.

- 3 Tekan  atau  ke *Pengaturan Radio* dan tekan  untuk memilih.

- 4 Tekan  atau  ke *Peredam AF* dan tekan  untuk memilih.
Anda juga bisa menggunakan *atau* untuk mengubah opsi yang dipilih.

- 5 Lakukan salah satu dari langkah berikut.

- Tekan  untuk mengaktifkan Peredam Umpan balik Akustik. Layar menampilkan  di sebelah *Diaktifkan*.
- Tekan  untuk menonaktifkan Peredam Umpan Balik Akustik. Tanda  hilang dari sebelah *Diaktifkan*.

Mengaktifkan atau Menonaktifkan GNSS

Global Navigation Satellite System (GNSS) adalah sistem navigasi satelit yang menentukan lokasi radio dengan tepat. GNSS meliputi Global Positioning System (GPS), Global Navigation Satellite System (GLONASS), dan BeiDou Navigation Satellite System (BDS).



PEMBERITAHUAN:

Model radio tertentu mungkin menawarkan GPS, GLONASS, dan BDS. Konstelasi GNSS dikonfigurasi menggunakan CPS. Tanyakan kepada dealer atau administrator sistem Anda untuk mengetahui bagaimana radio Anda diprogram.



- 1 Lakukan salah satu langkah berikut:

- Tekan tombol **GNSS** yang terprogram untuk mengaktifkan atau menonaktifkan fitur tersebut. Lompati langkah-langkah berikut ini.
- Tekan  untuk mengakses menu.

2 Tekan  atau  ke Utilitas. Tekan  untuk memilih.

3 Tekan  atau  ke Pengaturan Radio. Tekan  untuk memilih.

4 Tekan  atau  ke GNSS. Tekan  untuk memilih.



5 Tekan  untuk mengaktifkan/menonaktifkan GNSS.
Jika diaktifkan,  muncul di sebelah Diaktifkan.
Jika dinonaktifkan,  hilang dari sebelah Diaktifkan.

Lihat [Memeriksa Informasi GNSS di halaman 352](#) untuk informasi rinci tentang cara mengambil informasi GNSS.

Mengakses Informasi Radio Umum

Radio Anda memuat informasi tentang hal berikut ini:



- Baterai
- Derajat Kemiringan (Akselerometer)
- Indeks Nomor Model Radio
- Codeplug CRC Over-the-Air (OTA) Papan Opsi
- Nomor Site
- Info Site
- Alias dan ID Radio
- Versi Firmware dan Codeplug
- Informasi GNSS



Tekan  untuk kembali ke layar sebelumnya atau tekan lama  untuk kembali ke layar Awal. Radio keluar dari layar saat ini setelah pencatat waktu nonaktif berakhir.



Memeriksa Indeks Nomor Model Radio

Nomor indeks mengidentifikasi perangkat keras khusus model radio Anda. Administrator sistem radio Anda dapat meminta nomor ini saat menyiapkan codeplug Papan Opsi yang baru untuk radio.

- 1 Tekan  untuk mengakses menu.

- 2 Tekan  atau  ke `Utilitas` dan tekan  untuk memilih.



- 3 Tekan  atau  ke `Info Radio` dan tekan  untuk memilih.



- 4 Tekan  atau  ke `Indeks Model` dan tekan  untuk memilih.
Layar akan menampilkan Indeks Nomor Model.



Memeriksa CRC File Codeplug OTA Papan Opsi

Ikuti instruksi di bawah ini jika administrator sistem radio Anda meminta Anda menampilkan CRC (Pemeriksaan Redundansi Siklus) File Codeplug Papan Opsi OTA (melalui udara). Opsi menu ini hanya muncul jika Papan Opsi menerima pembaruan codeplug terakhir melalui udara (OTA).

- 1 Tekan  untuk mengakses menu.

- 2 Tekan  atau  ke `Utilitas` dan tekan  untuk memilih.

- 3 Tekan  atau  ke `Info Radio` dan tekan  untuk memilih.

- 4 Tekan  atau  ke OB OTA CPerc dan tekan  untuk memilih.

Layar akan menampilkan sejumlah huruf dan nomor. Komunikasikan informasi ini dengan administrator sistem radio Anda sebagaimana yang ditunjukkan.





Menampilkan ID Site (Nomor Site)









PEMBERITAHUAN:

Jika Anda saat ini tidak terdaftar di sebuah site, layar akan menampilkan Tidak Terdaftar.

Radio sekilas akan menampilkan ID Site saat terdaftar ke site Connect Plus. Setelah pendaftaran, radio biasanya tidak menunjukkan nomor Site. Untuk menampilkan nomor Site yang terdaftar, lakukan hal berikut:

- 1 Tekan  untuk mengakses menu.
 - 2 Tekan  atau  ke Utilitas dan tekan  untuk memilih.
-

- 3 Tekan  atau  ke Info Radio dan tekan  untuk memilih.
-

- 4 Tekan  atau  ke Nomor Site dan tekan  untuk memilih.

Layar akan menampilkan ID Jaringan dan Nomor Site.

Memeriksa Info Site



PEMBERITAHUAN:

Jika Anda saat ini tidak terdaftar di sebuah site, layar akan menampilkan Tidak Terdaftar.

Fitur Info Site memberikan informasi yang dapat berguna bagi teknisi servis. Fitur berisi informasi berikut:

- Jumlah repeater Saluran Kontrol saat ini.
- RSSI: Nilai kekuatan sinyal terakhir yang diukur dari repeater Saluran Kontrol.
- Neighbor List yang dikirim oleh repeater Saluran Kontrol (lima angka dipisahkan tanda koma).

Jika Anda diminta menggunakan fitur ini, laporkan informasi yang ditampilkan persis seperti yang muncul pada layar.

- 1 Tekan  untuk mengakses menu.



- 2 Tekan  atau  ke `Utilitas` dan tekan  untuk memilih.



- 3 Tekan  atau  ke `Info Radio` dan tekan  untuk memilih.



- 4 Tekan  atau  ke `Info Site` dan tekan  untuk memilih.
Layar akan menampilkan Info Site.

Ikuti prosedur berikut untuk mengakses fitur ini melalui layar radio.

- 1 Tekan  untuk mengakses menu.

- 2 Tekan  atau  ke `Utilitas` dan tekan  untuk memilih.

- 3 Tekan  atau  ke `Info Radio` dan tekan  untuk memilih.

- 4 Tekan  atau  ke `ID Saya` dan tekan  untuk memilih.
Layar akan menunjukkan ID radio.

Memeriksa ID Radio

Fitur ini menampilkan ID radio Anda.

Memeriksa Versi Firmware dan Versi Codeplug

Menampilkan versi firmware di radio.

- 1 Tekan  untuk mengakses menu.

- 2 Tekan  atau  ke `Utilitas` dan tekan  untuk memilih.

- 3 Tekan  atau  ke `Info Radio` dan tekan  untuk memilih.

- 4 Tekan  atau  ke `Versi` dan tekan  untuk memilih.

Layar akan menampilkan daftar informasi berikut:

- Versi Firmware (Radio)
- Versi Codeplug (Radio)
- Versi Firmware Papan Opsi
- Versi Frekuensi Papan Opsi

- Versi Perangkat Keras Papan Opsi
- Versi Codeplug Papan Opsi

Memeriksa Pembaruan

Connect Plus memberikan kemampuan untuk memperbarui file tertentu (Codeplug Papan Opsi, File Frekuensi Jaringan, dan File Firmware Papan Opsi) melalui udara (OTA).



PEMBERITAHUAN:

Tanyakan dealer atau administrator jaringan Anda untuk menentukan apakah fitur ini telah diaktifkan pada radio Anda.

Setiap radio Connect Plus dengan layar dapat menampilkan CRC Codeplug OTA Papan Opsi, versi File Frekuensi, atau versi file firmware Papan Opsi saat ini menggunakan opsi menu. Selain itu, radio dengan layar yang telah memiliki fitur transfer file melalui udara yang diaktifkan dapat menampilkan versi "file tertunda". "File tertunda" adalah File Frekuensi atau file firmware Papan Opsi yang diketahui radio Connect Plus melalui pengolahan pesan sistem, tetapi radio tersebut belum mengumpulkan semua paket file. Jika radio Connect Plus

dengan layar memiliki file tertunda, menu akan memberikan opsi untuk:

- Melihat nomor versi dari file tertunda.
- Melihat persentase paket yang sejauh ini sudah dikumpulkan.
- Meminta radio Connect Plus untuk terus mengumpulkan paket file.

Jika transfer file OTA Connect Plus diaktifkan pada radio, akan ada waktu saat radio secara otomatis bergabung dengan transfer file tanpa memberitahu pengguna radio terlebih dahulu. Saat radio sedang mengumpulkan paket file, LED berkedip merah dengan cepat dan radio menampilkan ikon Data Volume Tinggi pada bar status Layar Awal.



PEMBERITAHUAN:

Radio Connect Plus tidak dapat mengumpulkan paket file dan menerima panggilan secara bersamaan. Jika Anda ingin membatalkan transfer file, tekan dan lepaskan tombol **PTT**. Hal ini menyebabkan radio meminta panggilan pada Nama Kontak terpilih, dan akan membatalkan transfer file untuk radio tersebut hingga proses berlanjut di lain waktu.

Ada sejumlah hal yang dapat membuat proses transfer file dimulai kembali. Contoh pertama berlaku bagi semua jenis file OTA. Contoh lainnya hanya berlaku bagi File Frekuensi Jaringan dan File Firmware Papan Opsi:

- Administrator sistem radio memulai kembali transfer file OTA.
- Pencatat waktu Papan Opsi yang telah ditentukan habis, sehingga Papan Opsi melanjutkan proses pengumpulan paket secara otomatis.
- Pencatat waktu belum habis, tetapi pengguna radio meminta transfer file diteruskan melalui opsi menu.

Setelah radio Connect Plus selesai mengunduh semua paket file, radio tersebut harus memutakhirkan ke file yang baru diperoleh. Untuk File Frekuensi Jaringan, proses ini berlangsung secara otomatis dan radio tidak perlu diatur ulang. Untuk File Codeplug Papan Opsi, proses ini berlangsung secara otomatis yang akan menimbulkan gangguan singkat terhadap layanan karena Papan Opsi memuat informasi codeplug yang baru dan mendapatkan kembali site jaringan. Seberapa cepat radio memutakhirkan ke file firmware Papan Opsi yang baru bergantung pada bagaimana radio tersebut dikonfigurasi oleh dealer atau administrator sistem. Radio akan segera melakukan pemutakhiran setelah mengumpulkan semua paket file,

atau akan menunggu hingga saat berikutnya pengguna mengaktifkan radio.



PEMBERITAHUAN:

Tanyakan kepada dealer atau administrator sistem Anda untuk mengetahui bagaimana radio Anda diprogram.

Proses pemutakhiran ke file firmware Papan Opsi yang baru membutuhkan waktu beberapa detik, dan Papan Opsi Connect Plus harus mengatur ulang radio. Setelah pemutakhiran dimulai, pengguna radio tidak akan dapat melakukan atau menerima panggilan hingga proses selesai. Selama proses, layar radio memperingatkan pengguna agar tidak mematikan radio.

File Firmware

Bagian berikut memberikan informasi tentang firmware radio.



Pembaruan Firmware







PEMBERITAHUAN:



Jika file firmware Papan Opsi tidak Terbaru (dan jika sebagian radio telah mengumpulkan versi file firmware Papan Opsi yang lebih baru), radio menampilkan daftar dengan opsi tambahan; Versi, %Diterima, dan Unduh.

- 1 Tekan  untuk mengakses menu.











- 2 Tekan  atau  ke *Utilitas* dan tekan  untuk memilih.

- 3 Tekan  atau  ke *Info Radio* dan tekan  untuk memilih.

- 4 Tekan  atau  ke *Pembaruan* dan tekan  untuk memilih.

- 5 Tekan  atau  ke Firmware dan tekan  untuk memilih.
Layar akan menampilkan Firmware Diperbarui.
-

Firmware Tertunda – Versi

- 1 Tekan  untuk mengakses menu.
-
- 2 Tekan  atau  ke Utilitas dan tekan  untuk memilih.
-
- 3 Tekan  atau  ke Info Radio dan tekan  untuk memilih.
-
- 4 Tekan  atau  ke Pembaruan dan tekan  untuk memilih.
-





- 5 Tekan  atau  ke Firmware dan tekan  untuk memilih.
-



- 6 Tekan  atau  ke Versi dan tekan  untuk memilih.



Jika ada file firmware Papan Opsi yang tertunda, layar akan menampilkan nomor versi firmware yang tertunda tersebut.

Jika ada file firmware Papan Opsi tertunda, layar akan menampilkan Firmware Diperbarui.



Firmware Tertunda – % Diterima

- 1 Tekan  untuk mengakses menu.
-
- 2 Tekan  atau  ke Utilitas dan tekan  untuk memilih.
-

3 Tekan  atau  ke Info Radio dan tekan  untuk memilih.

4 Tekan  atau  ke Pembaruan dan tekan  untuk memilih.

5 Tekan  atau  ke Firmware dan tekan  untuk memilih.

6 Tekan  atau  ke %Diterima dan tekan  untuk memilih.

Layar akan menampilkan persentase paket file firmware yang dikumpulkan sejauh ini.



PEMBERITAHUAN:



Setelah 100%, radio perlu dinonaktifkan kemudian diaktifkan kembali untuk memulai pemutakhiran firmware.



Firmware Tertunda – Unduh



Jika radio Connect Plus sebelumnya meninggalkan Transfer File Firmware Papan Opsi OTA dengan file parsial, unit akan bergabung kembali dengan transfer file secara otomatis (jika masih berlangsung) saat pencatat waktu internal habis. Jika Anda ingin unit bergabung kembali dengan transfer File Firmware Papan Opsi yang sedang berlangsung sebelum pencatat waktu internal habis, gunakan opsi Unduh seperti dijelaskan di bawah.

1 Tekan  untuk mengakses menu.

2 Tekan  atau  ke Utilitas dan tekan  untuk memilih.

3 Tekan  atau  ke Info Radio dan tekan  untuk memilih.

4 Tekan  atau  ke Pembaruan dan tekan  untuk memilih.



5 Tekan  atau  ke Firmware dan tekan  untuk memilih.

6 Tekan  atau  ke Unduh dan tekan  untuk memilih.

Layar menampilkan hal berikut:

Unduhan Tersedia	Mulai Mengunduh
Tidak ada Unduhan Tersedia	Unduhan tidak tersedia

7 Lakukan salah satu langkah berikut:

- Pilih Ya dan tekan  untuk memulai pengunduhan.
- Pilih Tidak dan tekan  untuk kembali ke menu sebelumnya.

File Frekuensi

Bagian berikut memberikan informasi tentang file frekuensi radio.



Pembaruan File Frekuensi









PEMBERITAHUAN:

Jika File Frekuensi tidak Terbaru (dan jika radio sebagian telah mengumpulkan versi file frekuensi yang lebih baru), radio menampilkan daftar dengan opsi tambahan; Versi, %Diterima, dan Unduh.

1 Tekan  untuk mengakses menu.



2 Tekan  atau  ke Utilitas dan tekan  untuk memilih.



3 Tekan  atau  ke Info Radio dan tekan  untuk memilih.



- 4 Tekan  atau  ke Frekuensi dan tekan  untuk memilih.
Layar akan menampilkan Frek. File Diperbarui.
-



Penundaan File Frekuensi - Versi



- 1 Tekan  untuk mengakses menu.

 - 2 Tekan  atau  ke Utilitas dan tekan  untuk memilih.

 - 3 Tekan  atau  ke Info Radio dan tekan  untuk memilih.



 - 4 Tekan  atau  ke Pembaruan dan tekan  untuk memilih.
-



- 5 Tekan  atau  ke Frekuensi dan tekan  untuk memilih.
-



- 6 Tekan  atau  ke Versi dan tekan  untuk memilih.
Jika ada File Frekuensi yang tertunda, layar menampilkan nomor versi File Frekuensi yang tertunda.
-



Penundaan File Frekuensi - % Diterima

- 1 Tekan  untuk mengakses menu.

 - 2 Tekan  atau  ke Utilitas dan tekan  untuk memilih.

 - 3 Tekan  atau  ke Info Radio dan tekan  untuk memilih.
-

4 Tekan  atau  ke Pembaruan dan tekan  untuk memilih.

5 Tekan  atau  ke %Diterima dan tekan  untuk memilih.

Layar akan menampilkan persentase paket file frekuensi yang dikumpulkan sejauh ini.

Penundaan File Frekuensi - Unduh

Jika radio Connect Plus sebelumnya meninggalkan Transfer File Frekuensi Jaringan OTA dengan file parsial, unit akan bergabung kembali dengan transfer file secara otomatis (jika masih berlangsung) saat pencatat waktu internal habis. Jika Anda ingin unit bergabung kembali dengan transfer File Frekuensi Jaringan yang sedang berlangsung sebelum pencatat waktu internal habis, gunakan opsi Unduh seperti dijelaskan di bawah.

1 Tekan  untuk mengakses menu.

2 Tekan  atau  ke Utilitas dan tekan  untuk memilih.

3 Tekan  atau  ke Info Radio dan tekan  untuk memilih.

4 Tekan  atau  ke Pembaruan dan tekan  untuk memilih.

5 Tekan  atau  ke Frekuensi dan tekan  untuk memilih.

6 Tekan  atau  ke Unduh dan tekan  untuk memilih.

Unduhan Saat Ini Tidak Tersedia	Unduhan tidak tersedia
------------------------------------	---------------------------

Unduhan Saat Ini Tersedia	Mulai Mengunduh
------------------------------	-----------------

7 Lakukan salah satu langkah berikut:

- Pilih Ya dan tekan untuk memulai pengunduhan.
- Pilih Tidak dan tekan untuk kembali ke menu sebelumnya.

Memeriksa Informasi GNSS



Menampilkan informasi GNSS di radio, misalnya nilai:



- Garis Lintang
- Garis Bujur
- Ketinggian
- Arah
- Kecepatan
- HDOP (Penipisan Ketepatan secara Horizontal)
- Satelit



• Versi

1 Tekan  untuk mengakses menu.

2 Tekan  atau  ke Utilitas dan tekan  untuk memilih.

3 Tekan  atau  ke Info Radio dan tekan  untuk memilih.

4 Tekan  atau  ke Info GNSS dan tekan  untuk memilih.



5 Tekan  atau  ke item yang diperlukan dan tekan  untuk memilih.
Informasi GNSS yang diminta akan ditampilkan di layar.



Lihat [Mengaktifkan atau Menonaktifkan GNSS di halaman 339](#) untuk detail tentang GNSS.



Melihat Detail Sertifikat Wi-Fi Enterprise

Anda bisa melihat detail Sertifikat Wi-Fi Enterprise terpilih.

- 1 Tekan  untuk mengakses menu.

- 2 Tekan  atau  ke Utilitas. Tekan  untuk memilih.

- 3 Tekan  atau  ke Menu Sertifikat.
Tekan  untuk memilih.
✓ tampak di samping sertifikat yang siap.

- 4 Tekan  atau  ke sertifikat yang diinginkan.
Tekan  untuk memilih.

Radio Anda menampilkan detail lengkap dari sertifikat.



PEMBERITAHUAN:

Untuk sertifikat yang belum siap, layar hanya menampilkan Status.

Sistem Lainnya

Fitur yang tersedia untuk pengguna radio pada sistem ini tersedia dalam bab ini.

Tombol Push-To-Talk

Tombol Push-to-Talk **PTT** memiliki dua fungsi dasar:

- Saat panggilan sedang berlangsung, tombol **PTT** memungkinkan radio untuk mengirim transmisi ke radio lain dalam panggilan. Mikrofon diaktifkan saat tombol **PTT** ditekan.
- Saat tidak sedang dalam panggilan, tombol **PTT** digunakan untuk melakukan panggilan baru.

Tekan lama tombol **PTT** untuk berbicara. Lepaskan tombol **PTT** untuk mendengarkan.

Jika Nada Izin Bicara atau Sidetone PTT  diaktifkan, tunggu hingga nada peringatan pendek berakhir sebelum berbicara.

 Jika fitur Indikasi Saluran Bebas di radio aktif (diprogram oleh penyalur), Anda akan mendengar nada peringatan singkat diputar pada saat radio target (radio yang menerima panggilan) melepaskan tombol **PTT**,

menunjukkan bahwa saluran bebas untuk menerima tanggapan Anda.

 Anda mendengar Nada Larangan Bicara berkelanjutan jika panggilan Anda diinterupsi. Anda harus melepas tombol **PTT** jika mendengar Nada Larangan Bicara kontinu.

Tombol yang Dapat Diprogram

Tergantung pada durasi penekanan tombol, dealer dapat memprogram tombol yang dapat diprogram sebagai pintasan fungsi radio.

Tekan sebentar

Menekan dan melepaskan dengan cepat.

Tekan lama

Menekan dan menahan selama durasi terprogram.



PEMBERITAHUAN:

Lihat [Pengoperasian Darurat di halaman 438](#) untuk informasi selengkapnya tentang durasi terprogram untuk tombol **Darurat**.

Fungsi Radio yang Dapat Ditetapkan

Fungsi radio berikut ini dapat dialokasikan pada tombol yang dapat diprogram.

Ambien Audio

Memungkinkan pengguna memilih lingkungan tempat pengoperasian radio.

Profil Audio

Memungkinkan pengguna memilih profil audio yang diinginkan.

Sakelar Audio Bluetooth®

Mengalihkan perutean audio antara speaker radio internal dan aksesori berkemampuan Bluetooth eksternal.

Hubungkan Bluetooth

Menginisiasi operasi pencarian dan sambungan Bluetooth.

Putus Sambungan Bluetooth

Menghentikan semua sambungan Bluetooth yang ada antara radio dan perangkat berkemampuan Bluetooth.

Bluetooth Dapat Ditemukan

Memungkinkan radio memasuki Mode Bluetooth Dapat Ditemukan.

Peringatan Panggilan

Menyediakan akses langsung ke daftar kontak untuk memilih kontak yang akan dikirim Peringatan Panggilan.

Penerusan Panggilan

Mengaktifkan atau menonaktifkan Penerusan Panggilan.

Log Panggilan

Memilih daftar log panggilan.

Pengumuman Saluran

Memutar pesan suara pengumuman zona dan saluran untuk saluran saat ini.

Kontak

Memberikan akses langsung ke daftar Kontak.

Darurat

Menginisiasi atau membatalkan status darurat, tergantung pemrogramannya.

Alamat Publik (Public Address/PA) Eksternal

Mengalihkan perutean audio antara amplifier penguat suara PA yang terhubung dan sistem PA internal radio.

Lokasi Dalam Ruangan

Mengaktifkan atau menonaktifkan Lokasi Dalam Ruangan.

Audio Cerdas

Mengaktifkan atau menonaktifkan audio cerdas.

Panggilan Manual

Memulai Panggilan Pribadi dengan memasukkan ID subscriber apa pun.

Jelajah Site Manual⁷

Memulai pencarian site secara manual.

AGC Mik

Mengaktifkan atau menonaktifkan automatic gain control (AGC) mikrofon internal.

Monitor

Memonitor aktivitas pada saluran terpilih.

Notifikasi

Memberikan akses langsung ke daftar Notifikasi.

Penghapusan Saluran Gangguan⁷

Menghapus sementara saluran yang tidak dikehendaki, kecuali untuk Saluran Terpilih, dari daftar pindah. Saluran Terpilih merujuk ke zona terpilih atau kombinasi saluran pengguna yang menjadi awal tempat pemindaian.

Akses Satu Sentuhan

Langsung memulai Panggilan Pribadi, Telepon, atau Grup, Pemberitahuan Panggilan, pesan Teks Cepat, atau Balik Depan yang telah ditentukan.

Fitur Papan Opsi

Mengaktifkan atau menonaktifkan fitur papan opsi untuk saluran berkemampuan papan opsi.

Monitor Permanen⁷

Memonitor semua lalu lintas radio pada saluran terpilih sampai fungsi dinonaktifkan.

Telepon

Memberikan akses langsung ke daftar Kontak Telepon.

Privasi

Mengaktifkan atau menonaktifkan privasi.

Alamat Publik (Public Address/PA)

Mengaktifkan atau menonaktifkan sistem PA internal radio.

Alias dan ID Radio

Memberikan alias dan ID radio.

Pemeriksaan Radio

Menentukan apakah radio aktif dalam sistem.

⁷ Tidak berlaku dalam Capacity Plus.

Penonaktifan Radio 

Memungkinkan radio target dinonaktifkan dari jauh.

Pengaktifan Radio 

Memungkinkan radio target diaktifkan dari jauh.

Monitor Jarak Jauh

Mengaktifkan mikrofon radio target tanpa indikator apa pun.

Repeater/Talkaround⁷

Berganti antara menggunakan repeater dan berkomunikasi secara langsung dengan radio lainnya.

Atur Ulang Saluran Home

Menyiapkan saluran home baru.

Senyapkan Peningkat Saluran Home

Mematikan suara Peningkat Saluran Home.

Pemindaian⁸

Mengaktifkan atau menonaktifkan pemindaian.

Info Site

Menampilkan nama site saat ini dan ID Capacity Plus-Multi-Site.

Memutar pesan suara pengumuman site untuk site saat ini ketika Pengumuman Suara diaktifkan.

Kunci Site⁷ 

Ketika diaktifkan, radio akan mencari site saat ini saja. Ketika dinonaktifkan, radio akan mencari site lain di samping site saat ini.

Kontrol Telemetry 

Mengontrol Pin Output pada radio setempat atau yang berjarak jauh.

Pesan Teks 

Memilih menu pesan teks.

Dekey Jauh Interupsi Transmisi 

Menghentikan panggilan dapat disela yang sedang berlangsung untuk membebaskan saluran.

Peningkatan Trill

Mengaktifkan atau menonaktifkan peningkatan trill.

Pengumuman Suara Aktif/Nonaktif

Mengaktifkan atau menonaktifkan pengumuman suara.

Transmisi Pengoperasian Suara (VOX)

Mengaktifkan atau menonaktifkan VOX.

Wi-Fi

Mengaktifkan atau menonaktifkan Wi-Fi.

⁸ Tidak berlaku dalam Capacity Plus–Single-Site.

Pemilihan Zona

Memungkinkan pemilihan dari daftar zona.

Fungsi Utilitas atau Pengaturan yang Dapat Ditetapkan

Fungsi utilitas atau pengaturan radio berikut ini dapat ditetapkan ke tombol yang dapat diprogram.

Nada/Peringatan

Mengaktifkan atau menonaktifkan semua nada dan peringatan.

Lampu Latar

Menghidupkan atau mematikan lampu latar tampilan.

Saluran Naik/Turun

Tergantung pemrogramannya, mengubah saluran ke saluran sebelumnya atau berikutnya.

Mode Layar

Mengaktifkan atau menonaktifkan mode tampilan siang/malam hari.



Tingkat Daya



Mengganti antara tingkat kekuatan transmisi tinggi dan rendah.

Mengakses Fungsi Terprogram

Ikuti prosedur untuk mengakses fungsi-fungsi terprogram pada radio Anda.

- 1 Lakukan salah satu langkah berikut:
 - Tekan tombol yang diprogram. Lanjutkan ke [langkah 3](#).
 - Tekan  untuk mengakses menu.

- 2 Tekan  atau  ke fungsi menu, dan tekan  untuk memilih fungsi atau masuk sub-menu.

- 3 Lakukan salah satu langkah berikut:
 - Tekan  untuk kembali ke layar sebelumnya.
 - Tekan lama  untuk kembali ke layar Awal.

Radio keluar dari menu secara otomatis setelah tidak aktif selama waktu tertentu dan kembali ke layar Awal.

Tombol Navigasi Menu juga tersedia pada mikrofon keypad. Lihat [Tombol Mikrofon Keypad di halaman 39](#).

Indikator Status



Bab ini menjelaskan indikator status dan nada audio yang digunakan pada radio.







Ikon

Liquid Crystal Display (LCD) radio Anda menampilkan status radio, entri teks, dan entri menu.





Tabel 9: Ikon Layar

Ikon berikut ini muncul di bilah status pada bagian atas layar radio. Ikon disusun dari kiri berdasarkan kemunculan atau penggunaan, dan bersifat spesifik saluran.

	<p>BeiDou Only Tersedia⁹ </p> <p>Fitur BeiDou Only diaktifkan. Ikon akan terus menyala bila posisi tetap telah tersedia.</p>
---	---

	<p>Bluetooth Tersambung</p> <p>Fitur Bluetooth diaktifkan. Ikon akan menyala bila perangkat Bluetooth jauh tersambung.</p>
	<p>Bluetooth Tidak Tersambung</p> <p>Fitur Bluetooth diaktifkan, tetapi tidak ada perangkat Bluetooth jauh yang tersambung.</p>
	<p>Log Panggilan</p> <p>Log panggilan radio.</p>
	<p>Kontak</p> <p>Kontak radio tersedia.</p>
	<p>Darurat</p> <p>Radio dalam mode Darurat.</p>
	<p>Daftar Terima Fleksibel</p> <p>Daftar terima fleksibel diaktifkan.</p>







⁹ Hanya berlaku untuk XiR M8660i/XiR M8668i/CM7668i.

	GNSS Tersedia ¹⁰ Fitur GNSS diaktifkan. Ikon akan terus menyala bila posisi tetap telah tersedia.
	GNSS Tidak Tersedia ¹⁰ Fitur GNSS telah diaktifkan, tetapi tidak menerima data dari satelit.
	Data Volume Tinggi Radio menerima data volume tinggi dan saluran sedang sibuk.
	Lokasi Dalam Ruang Tersedia ¹⁰ Status lokasi dalam ruangan aktif dan tersedia.
	Lokasi Dalam Ruang Tidak Tersedia ¹⁰ Status lokasi dalam ruangan aktif tetapi tidak tersedia karena Bluetooth dinonaktifkan atau Beacons Scan dihentikan oleh Bluetooth.

	Pesan Pesan masuk.
	Monitor Saluran terpilih sedang dimonitor.
	Mode Bisu Mode Bisu aktif dan speaker dibisukan.
	Notifikasi Daftar Notifikasi memiliki satu atau beberapa aktivitas yang terlewat.
	Papan Opsi Papan Opsi diaktifkan. (Hanya untuk model yang dilengkapi papan opsi.)
	Papan Opsi Tidak Berfungsi Papan Opsi dinonaktifkan.

¹⁰ Hanya berlaku untuk model dengan perangkat lunak dan perangkat keras terbaru.



	<p>Pencatat Waktu Penundaan Pemrograman Melalui Udara Menunjukkan waktu yang tersisa sebelum radio menyala ulang otomatis.</p>
	<p>Indikator Kekuatan Sinyal yang Diterima (Received Signal Strength Indicator/RSSI) Jumlah baris yang ditampilkan menunjukkan kekuatan sinyal radio. Empat baris menunjukkan sinyal terkuat. Ikon ini hanya ditampilkan saat menerima.</p>
	<p>Larangan Tanggapan Larangan Tanggapan aktif.</p>
	<p>Hanya Dering Mode dering diaktifkan.</p>
	<p>Pindai¹¹ Fitur Pindai diaktifkan.</p>

	<p>Prioritas Pindai 1¹¹ Radio mendeteksi aktivitas pada saluran/kelompok yang ditetapkan sebagai Prioritas 1.</p>
	<p>Prioritas Pindai 2¹¹ Radio mendeteksi aktivitas pada saluran/kelompok yang ditetapkan sebagai Prioritas 2.</p>
	<p>Aman Fitur Privasi diaktifkan.</p>
	<p>Masuk Radio masuk ke server jauh.</p>
	<p>Keluar Radio keluar dari server jauh.</p>
	<p>Dering Tanpa Bunyi Mode dering tanpa bunyi diaktifkan.</p>
	<p>Jelajah Site¹² Fitur jelajah site diaktifkan.</p>

¹¹ Tidak berlaku dalam Capacity Plus.



¹² Tidak berlaku dalam Capacity Plus–Single-Site.

	¹¹Talkaround Dengan tidak adanya repeater, radio dikonfigurasi menjadi komunikasi langsung radio ke radio.
	Nada Nonaktif Nada dinonaktifkan.
	Tidak Aman Fitur Privasi dinonaktifkan.
	Vote Scan Fitur vote scan diaktifkan.
	Wi-Fi Sangat Baik¹³ Sinyal Wi-Fi sangat baik.
	Wi-Fi Baik¹³ Sinyal Wi-Fi baik.
	Wi-Fi Cukup¹³ Sinyal Wi-Fi cukup.

	Wi-Fi Jelek¹³ Sinyal Wi-Fi jelek.
	Wi-Fi Tidak Tersedia¹³ Sinyal Wi-Fi tidak tersedia.

Tabel 10: Ikon Menu Lanjutan



Ikon berikut ini muncul di samping item menu yang menawarkan pilihan di antara dua opsi atau sebagai indikasi bahwa ada sub-menu yang menawarkan dua opsi.

	Kotak Centang (Dicentang) Menunjukkan bahwa opsi dipilih.
	Kotak Centang (Kosong) Menunjukkan bahwa opsi tidak dipilih.
	Kotak Hitam Penuh Menunjukkan bahwa opsi dipilih untuk item menu dengan submenu.

¹³ Hanya berlaku untuk XiR M8668i/CM7668i.





Tabel 11: Ikon Perangkat Bluetooth



Ikon berikut juga ditampilkan di sebelah item dalam daftar perangkat berkemampuan Bluetooth yang tersedia untuk menunjukkan jenis perangkat.

	<p>Perangkat Audio Bluetooth Perangkat audio berkemampuan Bluetooth, misalnya headset.</p>
	<p>Perangkat Data Bluetooth Perangkat data berkemampuan Bluetooth, misalnya scanner.</p>
	<p>Perangkat PTT Bluetooth Perangkat PTT berkemampuan Bluetooth, misalnya POD (PTT-Only Device).</p>

Tabel 12: Ikon Panggilan







Ikon berikut ini muncul di layar selama panggilan. Ikon ini juga ditampilkan dalam daftar Kontak untuk menunjukkan jenis alias atau ID.

	<p>Panggilan PC Bluetooth Menunjukkan Panggilan PC Bluetooth sedang berlangsung. Dalam daftar Kontak, ini ditunjukkan sebagai alias (nama) atau ID (nomor) Panggilan PC Bluetooth.</p>
	<p>Panggilan Pengiriman Jenis kontak Panggilan Pengiriman digunakan untuk mengirim pesan teks ke PC pengirim melalui Server Pesan Teks pihak ketiga.</p>
	<p>Panggilan Grup/Semua Panggilan Menunjukkan Panggilan Grup atau Semua Panggilan sedang berlangsung. Dalam daftar Kontak, ini ditunjukkan sebagai alias (nama) atau ID (nomor) grup.</p>
	<p>Panggilan Pribadi Menunjukkan Panggilan Pribadi sedang berlangsung. Di Daftar Kontak, ini menunjukkan alias (nama) atau ID (nomor) subscriber.</p>

	<p>Panggilan Telepon sebagai Panggilan Grup/Semua Panggilan</p> <p>Menunjukkan Panggilan Telepon sebagai Panggilan Grup atau Semua Panggilan sedang berlangsung.</p> <p>Dalam daftar Kontak, ini ditunjukkan sebagai alias (nama) atau ID (nomor) grup.</p>
	<p>Panggilan Telepon sebagai Panggilan Pribadi</p> <p>Menunjukkan Panggilan Telepon sebagai Panggilan Pribadi sedang berlangsung.</p> <p>Dalam daftar Kontak, ini ditunjukkan sebagai alias (nama) atau ID (nomor) telepon.</p>

Tabel 13: Ikon Tiket Tugas

Ikon berikut muncul sebentar pada layar dalam folder Tiket Tugas.

	<p>Semua Tugas Menampilkan semua tugas tercantum.</p>
	<p>Tugas Baru Menampilkan tugas baru.</p>
	<p>Sedang Berlangsung Tugas dikirimkan. Hal ini dilihat sebelum indikasi untuk Mengirimkan Tiket Tugas Gagal atau Berhasil Terkirim.</p>
	<p>Gagal Terkirim Tugas tidak dapat dikirim.</p>
	<p>Berhasil Terkirim Tugas berhasil dikirim.</p>
	<p>Prioritas 1 Menunjukkan Tingkat Prioritas 1 untuk tugas.</p>
	<p>Prioritas 2 Menunjukkan Tingkat Prioritas 2 untuk tugas.</p>

**Prioritas 3**

Menunjukkan Tingkat Prioritas 3 untuk tugas.

Tabel 14: Ikon Pemberitahuan Mini

Ikon berikut ini ditampilkan sekilas di layar radio setelah tindakan untuk menjalankan sebuah tugas dilakukan.

**Transmisi Gagal (Negatif)**

Tindakan gagal dilakukan.

**Transmisi Berhasil (Positif)**

Tindakan berhasil dilakukan.

**Transmisi Sedang Berlangsung (Transisional)**

Mentransmisikan. Ikon terlihat sebelum indikasi Transmisi Berhasil atau Transmisi Gagal.

Tabel 15: Ikon Item Terkirim

Ikon berikut muncul di sudut kanan atas layar dalam folder Item Terkirim.



atau

**Sedang Berlangsung**

Pesan teks ke alias atau ID subscriber sedang menunggu transmisi, diikuti dengan menunggu respons.

Pesan teks ke alias atau ID grup sedang menunggu transmisi.



atau

**Pesan Terpisah atau Grup Telah Dibaca**

Pesan teks telah dibaca.



atau

**Pesan Terpisah atau Grup Belum Dibaca**

Pesan teks belum dibaca.



atau

**Gagal Terkirim**

Pesan teks tidak bisa terkirim.



Indikator LED

Indikator LED menampilkan status operasional radio.

Merah Berkedip

Radio gagal melakukan uji mandiri saat dihidupkan.

Radio menerima transmisi darurat.

Radio melakukan transmisi dalam kondisi baterai lemah.

Radio keluar dari jangkauan jika Sistem Transponder Auto-Range dikonfigurasi.

Mode Bisu aktif.

Hijau Tak Berkedip

Radio dalam proses dihidupkan.

Radio melakukan transmisi.

Radio sedang mengirim Peringatan Panggilan atau transmisi darurat.

Hijau Berkedip

Radio menerima panggilan atau data.

Radio mengambil transmisi Pemrograman Melalui Udara.

Radio mendeteksi aktivitas melalui udara.



PEMBERITAHUAN:

Aktivitas ini bisa memengaruhi saluran terprogram pada radio karena sifat dari protokol digital.

Tidak ada indikasi LED ketika radio mendeteksi aktivitas melalui udara dalam Capacity Plus.

Hijau Berkedip Ganda

Radio menerima panggilan atau data dengan privasi diaktifkan.

Kuning Terus

Radio sedang memantau saluran konvensional.

Radio dalam Mode Bluetooth Dapat Ditemukan.

Kuning Berkedip

Radio memindai aktivitas.

Radio belum merespons Peringatan Panggilan.

Daftar Terima Fleksibel pada radio diaktifkan.

Semua saluran Capacity Plus-Multi-Site sedang sibuk.

Kuning Berkedip Ganda

Jelajah Otomatis pada radio diaktifkan.

Radio secara aktif mencari site baru.

Radio belum merespons Peringatan Panggilan Grup.

Radio terkunci.

Radio tidak tersambung ke repeater ketika dalam Capacity Plus.

Semua saluran Capacity Plus sedang sibuk.

Nada

Berikut ini adalah nada yang keluar melalui speaker radio.



Nada Tinggi



Nada Rendah

Nada Indikator

Nada indikator memberi petunjuk suara tentang status setelah suatu tindakan untuk menjalankan tugas dilakukan.



Nada Indikator Positif



Nada Indikator Negatif

Nada Audio

Nada audio memberi Anda indikasi status radio yang bisa didengar atau respons radio terhadap data yang diterima.

**Nada Terus Menerus**

Nada monoton. Berbunyi secara terus-menerus sampai dihentikan.

**Nada Berkala**

Berbunyi secara berkala bergantung pada durasi yang diatur oleh radio. Nada memulai, berhenti, dan mengulang sendiri.

**Nada Berulang**

Nada tunggal yang berulang dengan sendirinya sampai dihentikan oleh pengguna.

Nada Sesaat

Berbunyi sekali dalam durasi singkat yang diatur oleh radio.

Mode Analog Konvensional dan Digital

Setiap saluran pada radio Anda bisa dikonfigurasi sebagai saluran analog konvensional atau saluran digital konvensional.

Gunakan **Pemilih Saluran** untuk beralih di antara saluran analog atau digital.

Fitur tertentu tidak tersedia jika beralih dari mode digital ke analog. Ikon untuk fitur digital menunjukkan perubahan ini dengan tampilan “abu-abu”. Fitur yang dinonaktifkan akan disembunyikan di dalam menu.

Radio juga dilengkapi fitur yang tersedia dalam mode analog dan digital. Meski demikian, perbedaan-perbedaan kecil dalam cara kerja masing-masing fitur **tidak** memengaruhi kinerja radio Anda.



PEMBERITAHUAN:

Radio juga beralih antara mode digital dan mode analog selama pemindaian mode ganda. Lihat [Pemindaian di halaman 417](#) untuk informasi selengkapnya.

Informasi tentang Ikon

Dalam publikasi ini, ikon yang dijelaskan digunakan untuk menunjukkan fitur yang didukung baik dalam mode analog konvensional maupun digital konvensional, atau yang tersedia dengan mikrofon berkemampuan keypad.



Menunjukkan fitur **Hanya Mode Analog**.



Menunjukkan fitur **Hanya Mode Digital** konvensional.

Untuk fitur yang tersedia dalam **kedua** mode analog dan digital konvensional, kedua ikon **tidak** ditampilkan.

IP Site Connect

Fitur ini digunakan radio untuk memperluas komunikasi konvensional melampaui jangkauan satu site dengan menyambung ke site lain yang tersedia menggunakan jaringan Internet Protocol (IP). Hanya tersedia untuk mode multisite konvensional.

Bila radio keluar dari jangkauan satu site dan masuk ke jangkauan site lainnya, maka radio akan tersambung ke repeater site baru untuk mengirim atau menerima panggilan atau transmisi data. Ini dilakukan secara otomatis atau manual, tergantung pada pengaturan Anda.

Dalam pencarian site otomatis, radio akan menelusuri semua site yang tersedia bila sinyal dari site aktif lemah atau bila radio tidak dapat mendeteksi sinyal apa pun dari site aktif. Selanjutnya, radio akan terkunci ke repeater dengan nilai Indikator Kekuatan Sinyal yang Diterima (RSSI) terkuat.

Pada pencarian site secara manual, radio mencari site berikutnya dalam daftar jelajah yang saat ini berada dalam jangkauan tetapi mungkin tidak memiliki sinyal terkuat, lalu terkunci di repeater tersebut.



PEMBERITAHUAN:

Tiap saluran hanya dapat mengaktifkan Pindai atau Jelajah, bukan keduanya secara bersamaan.

Saluran yang mengaktifkan fitur ini dapat ditambahkan ke daftar jelajah tertentu. Radio mencari saluran dalam daftar jelajah selama pengoperasian jelajah otomatis berlangsung untuk mencari site terbaik. Daftar jelajah mendukung hingga 16 saluran, termasuk Saluran yang dipilih.



PEMBERITAHUAN:

Anda tidak dapat menambah atau menghapus entri dalam daftar jelajah secara manual. Tanyakan kepada penyalur atau administrator sistem Anda untuk informasi lebih lanjut.

Capacity Plus–Single-Site

Capacity Plus–Single-Site merupakan konfigurasi trunking site tunggal pada sistem radio MOTOTRBO yang menggunakan rangkaian saluran untuk mendukung ratusan pengguna dan maksimum 254 Grup. Fitur ini memungkinkan radio secara efisien menggunakan sejumlah saluran terprogram yang tersedia saat berada dalam Mode Repeater.

Nada indikator negatif akan berbunyi jika Anda mencoba mengakses fitur yang tidak berlaku untuk Capacity Plus–

Single-Site dengan menekan tombol yang dapat diprogram.

Radio juga memiliki fitur yang tersedia dalam mode digital konvensional, IP Site Connect, dan Capacity Plus. Namun demikian, perbedaan-perbedaan kecil tentang cara masing-masing fitur berfungsi tidak memengaruhi kinerja radio Anda.

Untuk informasi lebih lanjut tentang konfigurasi ini, hubungi dealer atau administrator sistem.

Capacity Plus—Multi-Site

Capacity Plus—Multi-Site adalah konfigurasi trunking multichannel pada sistem radio MOTOTRBO, yang menggabungkan konfigurasi terbaik Capacity Plus dan IP Site Connect.

Capacity Plus—Multi-Site memungkinkan radio Anda memperluas komunikasi trunking melampaui jangkauan satu site dengan menyambung ke site lain yang tersedia dan tersambung dengan jaringan IP. Fitur ini juga memberikan peningkatan kapasitas dengan memanfaatkan gabungan jumlah saluran yang telah diprogram secara efisien yang didukung oleh setiap site yang tersedia.

Bila radio keluar dari jangkauan satu site dan masuk ke jangkauan site lainnya, maka radio akan tersambung ke

repeater site baru untuk mengirim atau menerima panggilan/transmisi data. Hal ini dilakukan secara otomatis atau manual, bergantung pada pengaturan radio Anda.

Jika diatur untuk melakukannya secara otomatis, radio akan menelusuri semua site yang tersedia bila sinyal dari site aktif lemah atau bila radio tidak dapat mendeteksi sinyal apa pun dari site aktif. Selanjutnya, radio akan terkunci ke repeater dengan nilai RSSI terkuat.

Pada pencarian site secara manual, radio mencari site berikutnya dalam daftar roaming yang saat ini berada dalam jangkauan (tetapi mungkin tidak memiliki sinyal terkuat), lalu terkunci pada site tersebut.

Saluran apa pun yang mengaktifkan Capacity Plus—Multi-Site dapat ditambahkan ke daftar jelajah tertentu. Radio mencari saluran tersebut selama pengoperasian jelajah otomatis untuk mencari site terbaik.



PEMBERITAHUAN:

Anda tidak dapat menambah atau menghapus entri dalam daftar jelajah secara manual. Tanyakan kepada penyalur atau administrator sistem Anda untuk informasi lebih lanjut.

Serupa dengan Capacity Plus—Single Site, ikon fitur yang tidak tersedia untuk Capacity Plus—Multi-Site tidak tersedia dalam menu. Nada indikator negatif akan berbunyi jika

Anda mencoba mengakses fitur yang tidak berlaku untuk Capacity Plus–Multi-Site dengan menekan tombol yang dapat diprogram.

Pemilihan Zona dan Saluran

Bab ini menjelaskan pengoperasian untuk memilih zona atau saluran di radio Anda. Zona adalah suatu grup saluran.

Radio Anda mendukung hingga 99 saluran dan 2 zona, dengan maksimum 99 saluran per zona.

Setiap saluran dapat diprogram dengan fitur yang berbeda dan/atau mendukung grup pengguna yang berbeda.

Memilih Zona

Ikuti prosedur untuk memilih zona yang diperlukan di radio Anda.

- 1 Lakukan salah satu langkah berikut:
 - Tekan tombol **Pemilihan Zona** terprogram. Lanjutkan ke [langkah 3](#).
 - Tekan  untuk mengakses menu.
-

- 2 Tekan  atau  ke Zona. Tekan  untuk memilih.

Layar menampilkan  dan zona saat ini.

- 3 Tekan  atau  ke zona yang diinginkan. Tekan  untuk memilih.

Layar sesaat menampilkan pesan <Zona>

Terpilih dan kembali ke layar zona yang dipilih.

Memilih Zona Menggunakan Pencarian Alias

Ikuti prosedur untuk memilih zona yang diperlukan di radio Anda menggunakan pencarian alias.

- 1 Tekan  untuk mengakses menu.
-

- 2 Tekan  atau  ke Zona. Tekan  untuk memilih.

Layar menampilkan  dan zona saat ini.

- 3 Masukkan karakter pertama dari alias yang diinginkan.

Layar menampilkan kursor berkedip.

- 4 Masukkan sisa karakter dari alias yang diperlukan.

Pencarian alias peka terhadap huruf besar-kecil. Jika terdapat dua entri atau lebih dengan nama yang sama, layar akan menampilkan entri pertama yang tercantum dalam daftar.

Baris teks pertama menampilkan karakter yang Anda masukkan. Baris teks berikut ini menampilkan hasil pencarian daftar pendek.

- 5 Tekan  untuk memilih.

Layar sesaat menampilkan pesan <Zona> Terpilih dan kembali ke layar zona yang dipilih.

Memilih Saluran

Ikuti prosedur untuk memilih saluran yang diperlukan di radio setelah Anda memilih zona.

Lakukan salah satu langkah berikut:

- Tekan tombol **Gulir Atas/Bawah**.
 - Gunakan **Kenop Volume/Saluran**.
 - Tekan tombol **Saluran Naik/Turun** terprogram.
-

Panggilan

Bab ini menjelaskan pengoperasian untuk menerima, merespons, melakukan, dan menghentikan panggilan.

Anda dapat memilih alias atau ID subscriber, atau alias atau ID grup setelah memilih saluran menggunakan satu dari fitur-fitur berikut ini:

Pencarian Alias

Metode ini digunakan untuk Panggilan Grup, Pribadi, dan Semua Panggilan saja dengan mikrofon keypad.

Daftar Kontak

Metode ini memberikan akses langsung ke daftar Kontak.

Panggilan Manual (menggunakan Kontak)

Metode ini digunakan untuk Panggilan Pribadi dan Telepon saja dengan mikrofon keypad.

Tombol Angka Terprogram

Metode ini digunakan untuk Panggilan Grup, Pribadi, dan Semua Panggilan saja dengan mikrofon keypad.



PEMBERITAHUAN:

Anda hanya dapat mempunyai satu alias atau ID yang dialokasikan ke satu tombol angka, tetapi beberapa tombol angka dapat dialokasikan ke satu alias atau ID. Semua tombol angka pada mikrofon keypad dapat dialokasikan. Lihat [Mengalokasikan Entri ke Tombol Angka yang Dapat Diprogram di halaman 423](#) untuk informasi selengkapnya.

Tekan Tombol Akses Satu Sentuhan

Metode ini hanya digunakan untuk Panggilan Grup, Pribadi, dan Telepon.

Hanya satu ID yang dapat dialokasikan ke tombol **Akses Satu Sentuhan** dengan menekan tombol yang dapat diprogram lama atau sebentar. Radio Anda bisa mempunyai beberapa tombol **Akses Satu Sentuhan** terprogram.

Tombol yang Dapat Diprogram

Metode ini digunakan untuk Panggilan Telepon saja.

Kenop Pemilih Saluran/Volume

Metode ini memilih alias atau ID subscriber, atau alias atau grup secara manual.

Lampu LED menyala hijau terus ketika radio sedang mengirimkan transmisi dan berkedip ketika radio sedang menerima.



PEMBERITAHUAN:

Lampu LED menyala hijau terus ketika radio sedang mentransmisikan dan berkedip hijau dua kali ketika radio menerima panggilan dengan privasi diaktifkan.

Untuk menguraikan panggilan dengan privasi aktif, radio harus memiliki Kunci Privasi, atau Nilai Kunci dan ID Kunci yang sama (diprogram oleh dealer) seperti radio yang melakukan transmisi (radio yang mengirimkan panggilan kepada Anda).

Lihat [Privasi di halaman 475](#) untuk informasi selengkapnya.

Panggilan Grup

Radio harus dikonfigurasi sebagai bagian dari grup untuk menerima panggilan dari atau melakukan panggilan ke sekelompok pengguna.

Melakukan Panggilan Grup

Ikuti prosedur untuk melakukan Panggilan Grup di radio Anda.

- 1 Lakukan salah satu langkah berikut:
 - Pilih saluran dengan ID atau alias grup yang aktif.
 - Tekan tombol **Akses Satu Sentuhan** terprogram.

- 2 Tekan tombol **PTT** untuk melakukan panggilan.

LED hijau akan menyala. Layar menampilkan ikon **Panggilan Grup** dan alias panggilan grup.

- 3 Lepaskan tombol **PTT** untuk mendengarkan.

LED hijau akan menyala jika radio target merespons. Layar menampilkan ikon **Panggilan Grup**, alias atau ID grup, dan alias atau ID radio yang melakukan transmisi.

- 4  Jika fitur Indikasi Saluran Bebas diaktifkan, nada peringatan singkat akan berbunyi saat pengguna radio yang melakukan transmisi melepaskan tombol **PTT**, yang menunjukkan saluran bebas dapat Anda gunakan untuk merespons. Tekan tombol **PTT** untuk menjawab panggilan.



Panggilan berakhir jika tidak ada aktivitas suara selama waktu yang telah ditentukan. Radio kembali ke layar sebelum Anda melakukan panggilan.

Melakukan Panggilan Grup Menggunakan Daftar Kontak

Ikuti prosedur untuk melakukan Panggilan Grup di radio Anda menggunakan daftar Kontak.

- 1 Tekan  untuk mengakses menu.

- 2 Tekan  atau  ke Kontak. Tekan  untuk memilih.

- 3 Tekan  atau  ke alias atau ID yang diinginkan. Tekan  untuk memilih.

- 4 Tekan tombol **PTT** untuk melakukan panggilan. LED hijau akan menyala.

- 5 Lepaskan tombol **PTT** untuk mendengarkan. LED hijau berkedip ketika ada pengguna dalam grup yang merespons. Layar menampilkan ikon dan alias atau ID **Panggilan Grup**, serta alias atau ID radio yang melakukan transmisi.

- 6  Jika fitur Indikasi Saluran Bebas diaktifkan, nada peringatan singkat akan berbunyi saat pengguna radio yang melakukan transmisi melepaskan tombol **PTT**, yang menunjukkan saluran bebas dapat Anda gunakan untuk merespons. Tekan tombol **PTT** untuk menjawab panggilan.

Panggilan berakhir jika tidak ada aktivitas suara selama waktu yang telah ditentukan.

Melakukan Panggilan Grup Menggunakan Tombol Angka yang Dapat Diprogram

Ikuti prosedur untuk melakukan Panggilan Grup di radio Anda menggunakan tombol angka yang dapat diprogram.

- 1 Tekan lama tombol angka terprogram ke alias atau ID yang telah ditentukan ketika Anda berada di layar Awal.

Jika sebuah tombol angka dialokasikan untuk sebuah entri dalam mode tertentu, fitur ini tidak didukung apabila Anda menekan lama tombol angka dalam mode yang lain.

Nada indikator negatif akan terdengar jika tombol angka tidak berhubungan dengan sebuah entri.

- 2 Tekan tombol **PTT** untuk melakukan panggilan. LED hijau akan menyala.

- 3 Lepaskan tombol **PTT** untuk mendengarkan. LED hijau berkedip ketika ada pengguna dalam grup yang merespons.

- 4  Jika fitur Indikasi Saluran Bebas diaktifkan, nada peringatan singkat akan berbunyi saat pengguna radio yang melakukan transmisi melepaskan tombol **PTT**, yang menunjukkan saluran bebas dapat Anda gunakan untuk merespons. Tekan tombol **PTT** untuk menjawab panggilan.

Panggilan berakhir jika tidak ada aktivitas suara selama waktu yang telah ditentukan. Radio kembali ke layar sebelum Anda melakukan panggilan.

Lihat [Mengalokasikan Entri ke Tombol Angka yang Dapat Diprogram di halaman 423](#) untuk informasi selengkapnya.

Merrespons Panggilan Grup



Untuk menerima panggilan dari sebuah grup, radio Anda harus dikonfigurasi sebagai bagian dari grup itu. Ikuti prosedur untuk merespons Panggilan Grup di radio Anda.

Bila menerima Panggilan Grup:

- LED akan berkedip hijau.
- Layar menampilkan ikon **Panggilan Grup** di sudut kanan atas.
- Baris teks pertama menampilkan alias pemanggil.
- Baris teks kedua menunjukkan alias panggilan grup.

- Radio bersuara dan panggilan masuk berbunyi melalui speaker.

1 Lakukan salah satu langkah berikut:

-  Jika fitur Indikasi Saluran Bebas diaktifkan, nada peringatan singkat akan berbunyi saat pengguna radio yang melakukan transmisi melepaskan tombol **PTT**, yang menunjukkan saluran bebas dapat Anda gunakan untuk merespons. Tekan tombol **PTT** untuk menjawab panggilan.
-  Jika Interupsi Suara diaktifkan, tekan tombol **PTT** untuk menginterupsi audio dari radio yang melakukan transmisi dan membebaskan saluran sehingga Anda dapat merespons.

LED hijau akan menyala.

2 Lakukan salah satu langkah berikut:

- Tunggu hingga Nada Izin Bicara selesai dan bicaralah dengan jelas ke mikrofon, jika diaktifkan.

-  Tunggu hingga Sidetone **PTT** selesai dan bicaralah dengan jelas ke mikrofon, jika diaktifkan.

3 Lepaskan tombol **PTT** untuk mendengarkan.

Panggilan berakhir jika tidak ada aktivitas suara selama waktu yang telah ditentukan.

Jika radio menerima Panggilan Grup ketika tidak berada di layar Awal, radio akan tetap di layarnya sekarang sebelum menjawab panggilan.

Tekan lama  untuk kembali ke layar Awal dan melihat alias pemanggil sebelum membalas.

Panggilan Pribadi

Panggilan Pribadi adalah sebuah panggilan dari radio perorangan ke radio perorangan lainnya.

Ada dua cara untuk menyiapkan Panggilan Pribadi. Jenis pertama adalah menyiapkan panggilan setelah melakukan pemeriksaan kehadiran radio, dan jenis kedua menyiapkan panggilan dengan segera. Hanya satu dari kedua jenis panggilan ini yang dapat diprogram untuk radio Anda oleh dealer.

Melakukan Panggilan Pribadi

Radio Anda harus diprogram sebelum memulai Panggilan Pribadi. Jika fitur ini tidak diaktifkan, nada indikator negatif berbunyi ketika Anda memulai panggilan. Ikuti prosedur untuk melakukan Panggilan Pribadi di radio Anda.

Gunakan fitur Pesan Teks atau Peringatan Panggilan untuk menghubungi radio individual. Untuk informasi selengkapnya, lihat [Pengolahan Pesan Teks di halaman 153](#) atau [Operasi Peringatan Panggilan di halaman 433](#).

1 Lakukan salah satu langkah berikut:

- Pilih saluran dengan ID atau alias subscriber yang aktif.
 - Tekan tombol **Akses Satu Sentuhan** terprogram.
-

2 Tekan tombol **PTT** untuk melakukan panggilan.

LED hijau akan menyala. Layar menampilkan ikon **Panggilan Pribadi**, alias subscriber, dan status panggilan.

3 Tunggu hingga Nada Izin Bicara selesai dan bicaralah dengan jelas ke mikrofon, jika diaktifkan.

- 4 Lepaskan tombol **PTT** untuk mendengarkan.
LED hijau akan berkedip jika radio target merespons.
-

- 5  Jika fitur Indikasi Saluran Bebas diaktifkan, nada peringatan singkat akan berbunyi saat pengguna radio yang melakukan transmisi melepaskan tombol **PTT**, yang menunjukkan saluran bebas dapat Anda gunakan untuk merespons. Tekan tombol **PTT** untuk menjawab panggilan.



Panggilan berakhir jika tidak ada aktivitas suara selama waktu yang telah ditentukan. Nada akan berbunyi. Layar menampilkan pesan **Panggilan Diakhiri**.

Melakukan Panggilan Pribadi Menggunakan Daftar Kontak

Ikuti prosedur untuk melakukan Panggilan Pribadi di radio Anda menggunakan daftar Kontak.

- 1 Tekan  untuk mengakses menu.
-

- 2 Tekan  atau  ke Kontak. Tekan  untuk memilih.
-

- 3 Tekan  atau  ke alias atau ID yang diinginkan. Tekan  untuk memilih.
-

- 4 Tekan tombol **PTT** untuk melakukan panggilan.
LED hijau akan menyala. Layar menampilkan alias tujuan.
-

- 5 Tunggu hingga Nada Izin Bicara selesai dan bicaralah dengan jelas ke mikrofon, jika diaktifkan.
-

- 6 Lepaskan tombol **PTT** untuk mendengarkan.
LED hijau akan berkedip jika radio target merespons. Layar akan menampilkan alias atau ID pengguna yang melakukan transmisi.
-

- 7  Jika fitur Indikasi Saluran Bebas diaktifkan, nada peringatan singkat akan berbunyi saat pengguna radio yang melakukan transmisi melepaskan tombol **PTT**, yang menunjukkan saluran bebas dapat Anda



gunakan untuk merespons. Tekan tombol **PTT** untuk menjawab panggilan.



Panggilan berakhir jika tidak ada aktivitas suara selama waktu yang telah ditentukan. Nada akan berbunyi. Layar menampilkan pesan Panggilan Diakhiri.



Melakukan Panggilan Pribadi Menggunakan Panggilan Manual

Ikuti prosedur untuk melakukan Panggilan Pribadi di radio Anda menggunakan panggilan manual.



- 1 Tekan  untuk mengakses menu.

- 2 Tekan  atau  ke Kontak. Tekan  untuk memilih.

- 3 Tekan  atau  ke Panggilan Manual. Tekan  untuk memilih.

- 4 Tekan  atau  ke Nomor Radio. Tekan  untuk memilih.

- 5 Lakukan salah satu langkah berikut:

- Masukkan ID subscriber, lalu tekan  untuk melanjutkan.
- Edit ID subscriber yang dipanggil sebelumnya, lalu tekan  untuk melanjutkan.

- 6 Tekan tombol **PTT** untuk melakukan panggilan. LED hijau akan menyala. Layar menampilkan alias tujuan.

- 7 Tunggu hingga Nada Izin Bicara selesai dan bicaralah dengan jelas ke mikrofon, jika diaktifkan.

- 8 Lepaskan tombol **PTT** untuk mendengarkan. LED hijau akan menyala jika radio target merespons. Layar akan menampilkan alias atau ID pengguna yang melakukan transmisi.

- 9  Jika fitur Indikasi Saluran Bebas diaktifkan, nada peringatan singkat akan berbunyi saat pengguna radio yang melakukan transmisi melepaskan tombol **PTT**, yang menunjukkan saluran bebas dapat Anda gunakan untuk merespons. Tekan tombol **PTT** untuk menjawab panggilan.

Panggilan berakhir jika tidak ada aktivitas suara selama waktu yang telah ditentukan. Nada akan berbunyi. Layar menampilkan pesan Panggilan Diakhiri.

Melakukan Panggilan Pribadi Menggunakan Tombol Angka yang Dapat Diprogram

Ikuti prosedur untuk melakukan Panggilan Pribadi di radio Anda menggunakan tombol angka yang dapat diprogram.

- 1 Tekan lama tombol angka terprogram ke alias atau ID yang telah ditentukan ketika Anda berada di layar Awal.
- Jika sebuah tombol angka dialokasikan untuk sebuah entri dalam mode tertentu, fitur ini tidak

didukung apabila Anda menekan lama tombol angka dalam mode yang lain.

Nada indikator negatif akan terdengar jika tombol angka tidak berhubungan dengan sebuah entri.

- 2 Tekan tombol **PTT** untuk melakukan panggilan. LED hijau akan menyala. Layar menampilkan ikon **Panggilan Pribadi** di sudut kanan atas. Baris teks pertama menampilkan alias pemanggil. Baris teks kedua menunjukkan status panggilan.
- 3 Lepaskan tombol **PTT** untuk mendengarkan. LED hijau akan berkedip jika radio target merespons. Layar menampilkan alias tujuan.
- 4  Jika fitur Indikasi Saluran Bebas diaktifkan, nada peringatan singkat akan berbunyi saat pengguna radio yang melakukan transmisi melepaskan tombol **PTT**, yang menunjukkan saluran bebas dapat Anda gunakan untuk merespons. Tekan tombol **PTT** untuk menjawab panggilan.
- Panggilan berakhir jika tidak ada aktivitas suara selama waktu yang telah ditentukan. Nada akan

berbunyi. Radio kembali ke layar sebelum Anda melakukan panggilan.

Lihat [Mengalokasikan Entri ke Tombol Angka yang Dapat Diprogram di halaman 423](#) untuk informasi selengkapnya.

Merespons Panggilan Pribadi

Ikuti prosedur untuk merespons Panggilan Pribadi di radio Anda.

Apabila Anda menerima panggilan pribadi:

- LED akan berkedip hijau.
- Radio bersuara dan panggilan masuk berbunyi melalui speaker.

1 Lakukan salah satu langkah berikut:

- Jika fitur Indikasi Saluran Bebas diaktifkan, nada peringatan singkat akan berbunyi saat pengguna radio yang melakukan transmisi melepaskan tombol **PTT**, yang menunjukkan saluran bebas dapat Anda gunakan untuk merespons. Tekan tombol **PTT** untuk menjawab panggilan.

- Jika fitur Mengirimkan Transmisi Interupsi Dekey Jarak Jauh diaktifkan, tekan tombol **PTT** untuk menghentikan panggilan yang dapat diinterupsi yang sedang berlangsung dan membebaskan saluran sehingga Anda dapat merespons.

LED hijau akan menyala.

- 2 Tunggu hingga Nada Izin Bicara selesai dan bicaralah dengan jelas ke mikrofon, jika diaktifkan.
- 3 Lepaskan tombol **PTT** untuk mendengarkan. Panggilan berakhir jika tidak ada aktivitas suara selama waktu yang telah ditentukan.

Semua Panggilan

Semua Panggilan adalah panggilan dari sebuah radio perorangan ke setiap radio pada saluran tersebut. Semua Panggilan digunakan untuk melakukan pengumuman penting yang memerlukan perhatian penuh dari pengguna. Pengguna pada saluran ini tidak dapat merespons Semua Panggilan.

Menerima Semua Panggilan

Apabila Anda menerima sebuah Semua Panggilan:

- Nada akan berbunyi.
- LED akan berkedip hijau.
- Layar menampilkan ikon **Panggilan Grup** di sudut kanan atas.
- Baris teks pertama menampilkan ID alias pemanggil.
- Baris teks kedua menampilkan Semua Panggilan.
- Radio bersuara dan panggilan masuk berbunyi melalui speaker.

Ketika panggilan berakhir, radio kembali ke layar sebelum menerima Semua Panggilan.

Sebelum berakhir, Semua Panggilan tidak menunggu selama waktu yang telah ditentukan sebelumnya.

🔊 Jika fitur Indikasi Saluran Bebas diaktifkan, Anda akan mendengar nada peringatan singkat pada saat radio yang melakukan transmisi melepaskan tombol **PTT**, yang menunjukkan bahwa saluran sudah bebas untuk Anda gunakan.

Anda tidak bisa menjawab Semua Panggilan.



PEMBERITAHUAN:

Radio berhenti menerima Semua Panggilan jika Anda beralih ke saluran lain ketika menerima panggilan tersebut. Anda tidak dapat melanjutkan navigasi menu atau mengedit sampai Semua Panggilan berakhir.

Melakukan Semua Panggilan

Radio harus diprogram sebelum Anda dapat melakukan Semua Panggilan. Ikuti prosedur untuk melakukan Semua Panggilan di radio Anda.

- 1 Pilih saluran dengan ID atau alias grup Semua Panggilan yang aktif.

- 2 Tekan tombol **PTT** untuk melakukan panggilan. LED hijau akan menyala. Layar menampilkan ikon **Panggilan Grup** dan Semua Panggilan.

- 3 Lakukan salah satu langkah berikut:
 - Tunggu hingga Nada Izin Bicara selesai dan bicaralah dengan jelas ke mikrofon, jika diaktifkan.

-  Tunggu hingga Sidetone **PTT** selesai dan bicaralah dengan jelas ke mikrofon, jika diaktifkan.

Pengguna pada saluran ini tidak bisa menjawab Semua Panggilan.

Melakukan Semua Panggilan Menggunakan Tombol Angka yang Dapat Diprogram

Ikuti prosedur untuk melakukan Semua Panggilan di radio Anda menggunakan tombol angka yang dapat diprogram.

- 1 Tekan lama tombol angka terprogram yang dialokasikan ke alias atau ID yang telah ditentukan ketika Anda berada di layar Awal.

Jika sebuah tombol angka dialokasikan untuk sebuah entri dalam mode tertentu, fitur ini tidak didukung apabila Anda menekan lama tombol angka dalam mode yang lain.

Nada indikator negatif akan terdengar jika tombol angka tidak berhubungan dengan sebuah entri.
-

- 2 Tekan tombol **PTT** untuk melakukan panggilan. LED hijau akan menyala.
-

- 3 Lepaskan tombol **PTT** untuk mendengarkan. LED hijau akan menyala jika radio target merespons. Anda tidak dapat menjawab Semua Panggilan pada saat ini.
-

- 4  Jika fitur Indikasi Saluran Bebas diaktifkan, nada peringatan singkat akan berbunyi saat pengguna radio yang melakukan transmisi melepaskan tombol **PTT**, yang menunjukkan saluran bebas dapat Anda gunakan untuk merespons. Tekan tombol **PTT** untuk menjawab panggilan.

Panggilan berakhir jika tidak ada aktivitas suara selama waktu yang telah ditentukan. Radio kembali ke layar sebelum Anda melakukan panggilan. Untuk Panggilan Pribadi, Anda akan mendengar nada singkat setelah panggilan berakhir.

Lihat [Mengalokasikan Entri ke Tombol Angka yang Dapat Diprogram di halaman 423](#) untuk informasi selengkapnya.

Panggilan Selektif

Panggilan Selektif adalah sebuah panggilan dari sebuah radio perorangan ke radio perorangan lainnya. Ini adalah Panggilan Pribadi pada sistem analog.

Melakukan Panggilan Selektif

Radio harus diprogram sebelum Anda memulai Panggilan Selektif. Ikuti prosedur untuk melakukan Panggilan Selektif di radio Anda.

- 1 Pilih saluran dengan ID atau alias subscriber yang aktif.

- 2 Tekan tombol **PTT** untuk melakukan panggilan. LED hijau akan menyala. Layar menampilkan ikon **Panggilan Pribadi**, alias subscriber, dan status panggilan.

- 3 Lakukan salah satu langkah berikut:
 - Tunggu hingga Nada Izin Bicara selesai dan bicaralah dengan jelas ke mikrofon, jika diaktifkan.

-  Tunggu hingga Sidetone **PTT** selesai dan bicaralah dengan jelas ke mikrofon, jika diaktifkan.

-
- 4 Lepaskan tombol **PTT** untuk mendengarkan. LED hijau akan menyala jika radio target merespons.
-

- 5  Jika fitur Indikasi Saluran Bebas diaktifkan, nada peringatan singkat akan berbunyi saat pengguna radio yang melakukan transmisi melepaskan tombol **PTT**, yang menunjukkan saluran bebas dapat Anda gunakan untuk merespons. Tekan tombol **PTT** untuk menjawab panggilan.

Panggilan berakhir jika tidak ada aktivitas suara selama waktu yang telah ditentukan.

-
- 6 Layar menampilkan pesan Panggilan Diakhiri.
-

Merespons Panggilan Selektif

Ikuti prosedur untuk merespons Panggilan Selektif di radio Anda.

Apabila Anda menerima Panggilan Selektif:

- LED akan berkedip hijau.

- Baris teks pertama menampilkan ikon **Panggilan Pribadi** dan alias pemanggil atau Panggilan Selektif atau Peringatan dengan Panggilan.
- Radio bersuara dan panggilan masuk berbunyi melalui speaker.

1 Tekan tombol **PTT** untuk menjawab panggilan.
LED hijau akan menyala.

2 Tunggu hingga Nada Izin Bicara selesai dan bicaralah dengan jelas ke mikrofon, jika diaktifkan.

3 Lepaskan tombol **PTT** untuk mendengarkan.
Panggilan berakhir jika tidak ada aktivitas suara selama waktu yang telah ditentukan. Nada akan berbunyi. Layar menampilkan pesan Panggilan Diakhiri.

Panggilan Telepon

Panggilan Telepon adalah panggilan dari radio perorangan ke telepon.

Jika kemampuan Panggilan Telepon tidak diaktifkan pada radio:

- Layar menampilkan Tidak tersedia.
- Radio menyembapkan panggilan.
- Radio kembali ke layar sebelumnya saat panggilan berakhir.

Selama Panggilan Telepon, radio mencoba mengakhiri panggilan jika:

- Anda menekan tombol **Akses Satu Sentuhan** dengan kode de-akses telah dikonfigurasi.
- Anda memasukkan kode de-akses sebagai input untuk digit ekstra.

Selama akses saluran, kode akses atau de-akses, atau transmisi digit ekstra, radio Anda akan merespons tombol atau kenop **On/Off**, **Kontrol Volume**, dan **Pemilih Saluran** saja. Nada akan berbunyi untuk tiap input yang tidak valid.

Selama akses saluran, tekan  untuk menghentikan upaya panggilan. Nada akan berbunyi.



PEMBERITAHUAN:

Kode akses atau de-akses tidak boleh lebih dari 10 karakter.

Tanyakan kepada penyalur atau administrator sistem Anda untuk informasi lebih lanjut.

Melakukan Panggilan Telepon

Ikuti prosedur untuk melakukan Panggilan Telepon di radio Anda.

- 1 Tekan tombol **Akses Satu Sentuhan** terprogram ke alias atau ID yang telah ditentukan.

Jika entri untuk tombol **Akses Satu Sentuhan** kosong, nada indikator negatif akan berbunyi. Jika kode akses tidak dikonfigurasi sebelumnya dalam Daftar Kontak, layar akan menampilkan Kode Akses:.

- 2 Masukkan kode akses, lalu tekan  untuk melanjutkan.

Kode akses atau de-akses tidak boleh lebih dari 10 karakter.

- 3 Tekan tombol **PTT** untuk menjawab panggilan. Lepaskan tombol **PTT** untuk mendengarkan.

- 4 Masukkan digit ekstra dengan keypad jika diminta oleh panggilan, lalu tekan  untuk melanjutkan.

Jika panggilan berakhir saat Anda memasukkan digit ekstra yang diminta oleh panggilan, radio kembali ke layar yang dibuka sebelum Anda memulai panggilan.

Nada Multi Frekuensi Dual Tone (DTMF) berbunyi. Radio kembali ke layar sebelumnya.

- 5 Tekan  untuk mengakhiri panggilan.

- 6 Lakukan salah satu langkah berikut:

- Jika kode de-akses belum dikonfigurasi, masukkan kode de-akses ketika layar

menampilkan Kode De-Akses:, lalu tekan  untuk melanjutkan.

Radio kembali ke layar sebelumnya.

- Tekan tombol **Akses Satu Sentuhan** terprogram. Jika entri untuk tombol **Akses Satu Sentuhan** kosong, nada indikator negatif akan berbunyi.

Nada DTMF berbunyi dan layar menampilkan Mengakhiri Panggilan Telepon.

Jika panggilan berhasil diakhiri:







- Nada akan berbunyi.

- Layar menampilkan pesan Panggilan Diakhiri.

Jika panggilan tidak berhasil diakhiri, radio kembali ke layar Panggilan Telepon. Ulangi dua langkah terakhir atau tunggu hingga pengguna telepon mengakhiri panggilan.

Melakukan Panggilan Telepon Menggunakan Daftar Kontak

Ikuti prosedur untuk melakukan Panggilan Telepon di radio Anda menggunakan daftar Kontak.

- 1 Tekan  untuk mengakses menu.
- 2 Tekan  atau  ke Kontak. Tekan  untuk memilih.
Layar menampilkan entri sesuai urutan abjad.
- 3 Tekan  atau  ke alias atau ID yang diinginkan. Tekan  untuk memilih.

Jika Anda menekan tombol **PTT** ketika berada di layar Kontak Telepon:

- Baris pertama layar menampilkan Nomor Telepon:.
- Baris kedua layar menampilkan kursor yang berkedip.

Jika entri yang dipilih kosong:

- Nada indikator negatif akan berbunyi.
- Layar menampilkan pesan Panggilan Telepon Tidak Valid #.

-
- 4 Tekan  atau  ke Panggilan Telepon. Tekan  untuk memilih.

Layar menampilkan Kode Akses: jika kode akses tidak dikonfigurasi di awal.

-
- 5 Masukkan kode akses, lalu tekan  untuk melanjutkan.

Kode akses atau de-akses tidak boleh lebih dari 10 karakter.

Baris teks pertama akan menampilkan `Memanggil`. Baris kedua teks menampilkan alias atau ID subscriber, dan ikon **Panggilan Telepon**.

Jika panggilan berhasil:

- Nada DTMF akan berbunyi.
- Nada panggilan dari pengguna telepon akan terdengar.
- Baris pertama teks menampilkan alias atau ID subscriber dan ikon **RSSI**.
- Baris kedua teks menampilkan `Panggilan Telepon`, dan ikon **Panggilan Telepon**.

Jika panggilan tidak berhasil:

- Nada akan berbunyi.
- Layar menampilkan `Panggilan Telepon Gagal` lalu, `Kode Akses:`.
- Radio kembali ke layar yang dibuka sebelum Anda memulai panggilan jika kode akses telah dikonfigurasi sebelumnya di daftar Kontak.

- 6 Tekan tombol **PTT** untuk menjawab panggilan. Ikon **RSSI** muncul.

-
- 7 Lepaskan tombol **PTT** untuk mendengarkan.

- 8 Masukkan digit ekstra dengan keypad jika diminta oleh panggilan, lalu tekan  untuk melanjutkan. Jika panggilan berakhir saat Anda memasukkan digit ekstra yang diminta oleh panggilan, radio kembali ke layar yang dibuka sebelum Anda memulai panggilan. Nada DTMF akan berbunyi. Radio kembali ke layar sebelumnya.

-
- 9 Tekan  untuk mengakhiri panggilan.

-
- 10 Jika kode de-akses belum dikonfigurasi, masukkan kode de-akses ketika layar menampilkan `Kode De-Akses:`, lalu tekan  untuk melanjutkan.

Radio kembali ke layar sebelumnya. Nada DTMF berbunyi dan layar menampilkan `Mengakhiri Panggilan Telepon`.

Jika panggilan berhasil diakhiri:

- Nada akan berbunyi.
- Layar menampilkan pesan Panggilan Diakhiri.

Jika panggilan tidak berhasil diakhiri, radio kembali ke layar Panggilan Telepon. Ulangi [langkah 9](#) dan [langkah 10](#), atau tunggu hingga pengguna telepon mengakhiri panggilan. Jika Anda menekan tombol **PTT** saat berada di layar Kontak Telepon, nada akan berbunyi dan layar menampilkan Tekan OK untuk Melakukan Panggilan.

Jika pengguna telepon mengakhiri panggilan, nada berbunyi dan layar menampilkan dan layar menampilkan Panggilan Telepon Diakhiri.

Jika panggilan berakhir saat Anda memasukkan digit ekstra yang diminta oleh Panggilan Telepon, radio kembali ke layar yang dibuka sebelum Anda memulai panggilan.



PEMBERITAHUAN:

Selama akses saluran, tekan  untuk menghentikan percobaan panggilan dan nada akan berbunyi.

Selama panggilan, saat Anda menekan tombol **Akses Satu Sentuhan** dengan kode de-akses yang dikonfigurasi sebelumnya atau memasukkan kode de-akses sebagai input untuk digit ekstra, radio akan mencoba mengakhiri panggilan.

Saat mengakses saluran dan melakukan transmisi kode akses/de-akses atau digit ekstra, radio hanya merespons tombol **On/Off**, **Kenop Volume**, dan **Pemilih Saluran**. Nada akan berbunyi untuk tiap input yang tidak valid.



Melakukan Panggilan Telepon Menggunakan Panggilan Manual

Ikuti prosedur untuk melakukan Panggilan Telepon di radio Anda menggunakan panggilan manual.

- 1 Tekan  untuk mengakses menu.

2 Tekan  atau  ke Kontak. Tekan  untuk memilih.

3 Tekan  atau  ke Panggilan Manual. Tekan  untuk memilih.

4 Tekan  atau  ke Nomor Telepon. Tekan  untuk memilih. Layar menampilkan Nomor: dan kursor berkedip.

5 Masukkan nomor telepon, lalu tekan  untuk melanjutkan. Layar menampilkan Kode Akses: dan kursor berkedip jika kode akses belum dikonfigurasi.

6 Masukkan kode akses, lalu tekan  untuk melanjutkan. Kode akses atau de-akses tidak boleh lebih dari 10 karakter.

7 LED hijau akan menyala. Layar menampilkan ikon **Panggilan Telepon** di sudut kanan atas. Baris teks pertama menunjukkan alias subscriber. Baris teks kedua menunjukkan status panggilan. Jika panggilan berhasil:

- Nada DTMF akan berbunyi.
- Nada panggilan dari pengguna telepon akan terdengar.
- Baris teks pertama menunjukkan alias subscriber.
- Layar terus menampilkan ikon **Panggilan Telepon** di sudut kanan atas.

Jika panggilan tidak berhasil:

- Nada akan berbunyi.
 - Layar menampilkan Panggilan Telepon Gagal lalu, Kode Akses:.
 - Radio kembali ke layar yang dibuka sebelum memulai panggilan jika kode akses telah dikonfigurasi sebelumnya di daftar Kontak.
-

8 Tekan  untuk mengakhiri panggilan.

9 Lakukan salah satu langkah berikut:

- Jika kode de-akses belum dikonfigurasi, masukkan kode de-akses ketika layar

menampilkan Kode De-Akses:, lalu tekan  untuk melanjutkan.

Radio kembali ke layar sebelumnya.

- Tekan tombol **Akses Satu Sentuhan** terprogram. Jika entri untuk tombol **Akses Satu Sentuhan** kosong, nada indikator negatif akan berbunyi.

Nada DTMF berbunyi dan layar menampilkan Mengakhiri Panggilan Telepon.

Jika panggilan berhasil diakhiri:

- Nada akan berbunyi.
- Layar menampilkan pesan Panggilan Diakhiri.

Jika panggilan tidak berhasil diakhiri, radio kembali ke layar Panggilan Telepon. Ulangi [langkah 8](#), atau tunggu hingga pengguna telepon mengakhiri panggilan.



PEMBERITAHUAN:

Saat Anda menekan tombol **PTT** saat berada di layar Kontak Telepon, nada akan berbunyi dan layar menampilkan Press OK to Place Phone Call (Tekan OK untuk Melakukan Panggilan).

Saat pengguna telepon mengakhiri panggilan, nada akan berbunyi dan layar akan menampilkan Panggilan Diakhiri.

Jika panggilan berakhir saat Anda memasukkan digit ekstra yang diminta oleh Panggilan Telepon, radio kembali ke layar yang dibuka sebelum Anda memulai panggilan.

Selama akses saluran, tekan  untuk menghentikan percobaan panggilan dan nada akan berbunyi.



Selama panggilan, saat Anda menekan tombol **Akses Satu Sentuhan** dengan kode de-akses yang dikonfigurasi sebelumnya atau memasukkan kode de-akses sebagai input untuk digit ekstra, radio akan mencoba mengakhiri panggilan.



Saat mengakses saluran dan melakukan transmisi kode akses/de-akses atau digit ekstra, radio hanya merespons tombol **On/Off**, **Kenop Volume**, dan **Pemilih Saluran**. Nada akan berbunyi untuk tiap input yang tidak valid.

Melakukan Panggilan Grup, Pribadi, Telepon, atau Semua Panggilan Menggunakan Pencarian Alias 🌐 📞





Ikuti prosedur untuk melakukan panggilan apa pun menggunakan pencarian alias.

- 1 Tekan  untuk mengakses menu.

 - 2 Tekan  atau  ke Kontak. Tekan  untuk memilih.
Layar menampilkan entri sesuai urutan abjad.
-



- 3 Tekan  atau  ke alias atau ID subscriber yang diinginkan. Baris pertama layar menampilkan Nomor Telepon:. Baris kedua layar menampilkan kursor yang berkedip. Gunakan keypad untuk memasukkan nomor telepon.
-

- 4 Tekan  untuk memilih. Jika entri yang dipilih kosong, nada indikator negatif akan berbunyi dan layar menampilkan Phone Call Invalid # (Panggilan Telepon Tidak Valid #).
-

- 5 Tekan  atau  ke Panggil Telepon dan Tekan  untuk memilih. Jika kode akses tidak dikonfigurasi sebelumnya dalam daftar Kontak, baris pertama pada layar menampilkan Kode Akses:. Baris kedua layar menampilkan kursor yang berkedip. Masukkan kode akses dan tekan tombol  untuk melanjutkan. Jika berhasil, nada DTMF terdengar. Nada panggilan dari pengguna telepon akan terdengar. Baris pertama layar menampilkan alias atau ID subscriber, dan ikon RSSI. Baris kedua layar menampilkan Panggil Telepon dan ikon Panggilan Telepon. Jika tidak berhasil, nada



terdengar dan layar menampilkan Panggilan Telepon Gagal. Radio Anda kembali ke layar input Kode Akses. Jika kode akses telah dikonfigurasi sebelumnya di daftar Kontak, radio akan kembali ke layar tempat Anda berada sebelum memulai panggilan.

-
- 6 Tekan tombol **PTT** untuk berbicara dan lepaskan untuk mendengarkan. Ikon RSSI tidak ditampilkan selama transmisi.
-
- 7 Untuk memasukkan digit ekstra, jika diminta oleh Panggilan Telepon, lakukan salah satu hal berikut.
- Tekan sembarang tombol keypad untuk mulai memasukkan digit ekstra. Baris pertama layar menampilkan `Digit Ekstra:`. Baris kedua layar menampilkan kursor yang berkedip. Masukkan digit ekstra dan tekan tombol  untuk melanjutkan. Nada DTMF terdengar dan radio kembali ke layar sebelumnya.
 - Tekan tombol **Akses Satu Sentuhan**. Nada DTMF akan berbunyi. Jika entri untuk tombol **Akses Satu Sentuhan** kosong, nada indikator negatif akan berbunyi.
-

- 8 Tekan  untuk mengakhiri panggilan. Jika kode de-akses tidak dikonfigurasi sebelumnya dalam daftar Kontak, baris pertama layar akan menampilkan `De-Access Code:` (Kode De-Akses:). Baris kedua layar menampilkan kursor yang berkedip. Masukkan kode de-akses dan tekan  untuk melanjutkan. Radio kembali ke layar sebelumnya. Nada DTMF berbunyi dan layar menampilkan `Ending Phone Call` (Mengakhiri Panggilan Telepon). Jika berhasil, nada terdengar dan layar menampilkan `Panggilan Telepon Diakhiri`. Radio Anda kembali ke layar Panggilan Telepon. Jika tidak berhasil, radio Anda kembali ke layar Panggilan Telepon. Jika Anda menekan tombol **PTT** saat berada di layar Kontak Telepon, nada akan berbunyi dan layar menampilkan `Tekan OK untuk Melakukan Panggilan`. Jika pengguna telepon mengakhiri panggilan, nada berbunyi dan layar menampilkan `Phone Call Ended` (Panggilan Telepon Diakhiri). Jika panggilan berakhir saat Anda memasukkan digit ekstra yang diminta oleh Panggilan Telepon, radio kembali ke layar yang dibuka sebelum Anda memulai panggilan.
-

**PEMBERITAHUAN:**

Selama akses saluran, tekan  untuk menghentikan percobaan panggilan dan nada akan berbunyi atau untuk keluar dari pencarian alias.

Tekan  atau  untuk keluar dari pencarian alias. Selama panggilan, saat Anda menekan tombol **Akses Satu Sentuhan** dengan kode de-akses yang dikonfigurasi sebelumnya atau memasukkan kode de-akses sebagai input untuk digit ekstra, radio akan mencoba mengakhiri panggilan. Saat mengakses saluran dan melakukan transmisi kode akses/de-akses atau digit ekstra, radio hanya merespons tombol On/Off, Kenop Volume, dan Pemilih Saluran. Nada akan berbunyi untuk tiap input yang tidak valid.

Multi Frekuensi Dual Tone



Fitur Multi Frekuensi Dual Tone (DTMF) memungkinkan radio beroperasi dalam sistem radio dengan antarmuka ke sistem telepon.

Anda dapat mematikan nada DTMF dengan menonaktifkan semua nada dan peringatan radio. Lihat [Mengaktifkan atau Menonaktifkan Nada/Peringatan Radio di halaman 208](#) untuk informasi selengkapnya.

Memulai Panggilan DTMF

Ikuti prosedur untuk memulai panggilan DTMF di radio Anda.

- 1 Tekan dan tahan tombol **PTT**.

- 2 Lakukan salah satu langkah berikut:
 - Masukkan nomor yang diinginkan untuk memulai panggilan DTMF.
 - Tekan  untuk memulai panggilan DTMF.
 - Tekan  untuk memulai panggilan DTMF.

Merrespons Panggilan Telepon sebagai Panggilan Grup

Ikuti prosedur untuk merrespons Panggilan Telepon sebagai Panggilan Grup di radio Anda.

Saat menerima Panggilan Telepon sebagai Panggilan Grup:

- Layar menampilkan ikon **Panggilan Telepon** di sudut kanan atas.

- Layar menampilkan alias grup atau Panggilan Telepon.

Jika kemampuan Panggilan Telepon tidak diaktifkan pada radio, baris pertama layar akan menunjukkan Tidak Tersedia dan radio Anda membisukan panggilan. Radio kembali ke layar sebelumnya saat panggilan berakhir.

- 1 Tekan tombol **PTT** untuk menjawab panggilan. Lepaskan tombol **PTT** untuk mendengarkan.
-

- 2 Tekan  untuk mengakhiri panggilan.

Layar menampilkan Mengakhiri Panggilan Telepon.

Jika panggilan berhasil diakhiri:

- Nada akan berbunyi.
- Layar menampilkan pesan Panggilan Diakhiri.

Jika panggilan tidak berhasil diakhiri, radio kembali ke layar Panggilan Telepon. Ulangi langkah ini atau tunggu hingga pengguna telepon mengakhiri panggilan.

Merespons Panggilan Telepon sebagai Semua Panggilan

Saat menerima Panggilan Telepon sebagai Semua Panggilan, Anda dapat merespons atau mengakhiri panggilan, hanya jika jenis Semua Panggilan ditetapkan ke saluran. Ikuti prosedur untuk merespons Panggilan Telepon sebagai Semua Panggilan di radio Anda.

Saat menerima Panggilan Telepon sebagai Semua Panggilan:

- Layar menampilkan ikon **Panggilan Telepon** di sudut kanan atas.
- Layar menampilkan Semua Panggilan dan Panggilan Telepon.

Jika kemampuan Panggilan Telepon tidak diaktifkan pada radio, baris pertama layar akan menunjukkan Tidak Tersedia dan radio Anda membisukan panggilan.

Radio kembali ke layar sebelumnya saat panggilan berakhir.

- 1 Tekan tombol **PTT** untuk menjawab panggilan.
-

- 2 Lepaskan tombol **PTT** untuk mendengarkan.
-

- 3 Tekan  untuk mengakhiri panggilan.

Layar menampilkan Mengakhiri Panggilan Telepon.

Jika panggilan berhasil diakhiri:

- Nada akan berbunyi.
- Layar menampilkan Semua Panggilan dan Panggilan Berakhir.

Jika panggilan tidak berhasil diakhiri, radio kembali ke layar Panggilan Telepon. Ulangi [langkah 3](#) atau tunggu hingga pengguna telepon mengakhiri panggilan.

Merespons Panggilan Telepon sebagai Panggilan Pribadi

Ikuti prosedur untuk merespons Panggilan Telepon sebagai Panggilan Pribadi di radio Anda.

Saat menerima Panggilan Telepon sebagai Panggilan Pribadi:

- Layar menampilkan ikon **Panggilan Telepon** di sudut kanan atas.

- Layar menampilkan alias pemanggil atau Panggilan Telepon.

Jika kemampuan Panggilan Telepon tidak diaktifkan pada radio, baris pertama layar akan menunjukkan Tidak Tersedia dan radio Anda membisukan panggilan. Radio kembali ke layar sebelumnya saat panggilan berakhir.

- 1 Tekan tombol **PTT** untuk menjawab panggilan. Lepaskan tombol **PTT** untuk mendengarkan.
-

- 2 Tekan  untuk mengakhiri panggilan.

Layar menampilkan Mengakhiri Panggilan Telepon.

Jika panggilan berhasil diakhiri:

- Nada akan berbunyi.
- Layar menampilkan pesan Panggilan Diakhiri.

Jika panggilan tidak berhasil diakhiri, radio kembali ke layar Panggilan Telepon. Ulangi langkah ini atau tunggu hingga pengguna telepon mengakhiri panggilan.

Menghentikan Panggilan Radio

Dengan fitur ini Anda bisa menghentikan Panggilan Grup atau Pribadi yang sedang berlangsung guna membebaskan saluran untuk transmisi. Misalnya, ketika radio mengalami kondisi “mikrofon macet” di mana tombol **PTT** secara tak sengaja ditekan oleh pengguna lain. Radio harus diprogram agar Anda bisa menggunakan fitur ini. Ikuti prosedur untuk menghentikan panggilan di radio Anda.

1 Tekan tombol **Dekey Jauh Interupsi Transmisi**.

Layar menampilkan Dekey Jauh.

2 Tunggu respons.

Jika berhasil:

- Nada indikator positif akan berbunyi.
- Layar menampilkan Dekey Jauh Berhasil.

Jika tidak berhasil:

- Nada indikator negatif akan berbunyi.
 - Layar menampilkan Dekey Jauh Gagal.
-



PEMBERITAHUAN:

Tanyakan kepada penyalur atau administrator sistem Anda untuk informasi lebih lanjut.

Talkaround

Fitur ini memungkinkan Anda terus berkomunikasi ketika repeater tidak beroperasi, atau ketika radio berada di luar jangkauan dari repeater tetapi dalam jangkauan bicara radio lain.

Pengaturan talkaround disimpan bahkan setelah radio dimatikan.



PEMBERITAHUAN:

Fitur ini tidak berlaku di Capacity Plus–Single-Site, Capacity Plus–Multi-Site, dan saluran Citizens Band yang berada dalam frekuensi yang sama.

Beralih Antara Mode Repeater dan Talkaround

Ikuti prosedur untuk beralih antara mode Repeater dan Talkaround di radio Anda.

- 1 Lakukan salah satu langkah berikut:

- Tekan tombol **Repeater/Talkaround** yang terprogram. Lompati langkah-langkah berikut ini.
- Tekan  untuk mengakses menu.

2 Tekan  atau  ke **Utilitas**. Tekan  untuk memilih.

3 Tekan  atau  ke **Pengaturan Radio**. Tekan  untuk memilih.

4 Tekan  atau  ke **Talkaround**. Tekan  untuk memilih.

Jika diaktifkan,  muncul di sebelah **Diaktifkan**.

Jika dinonaktifkan,  hilang dari sebelah **Diaktifkan**.

Layar kembali ke layar sebelumnya secara otomatis.

Panggilan Suara Siaran

Panggilan Suara Siaran adalah panggilan suara satu arah dari pengguna ke seluruh grup bicara.

Fitur Panggilan Suara Siaran memungkinkan hanya pengguna yang memulai panggilan yang melakukan transmisi ke grup bicara, sedangkan penerima panggilan tidak dapat merespons (tanpa Pengatur Waktu Hang Panggilan).

Radio harus diprogram agar Anda bisa menggunakan fitur ini. Tanyakan kepada penyalur atau administrator sistem Anda untuk informasi lebih lanjut.

Melakukan Panggilan Suara Siaran

Program radio Anda untuk melakukan Panggilan Suara Siaran.

- 1 Pilih saluran dengan ID atau alias grup yang aktif.
- 2 Tekan tombol **PTT** untuk melakukan panggilan. LED hijau akan menyala. Layar menampilkan Panggilan Siaran, ikon dan alias **Panggilan Grup**.

- 3 Lakukan salah satu langkah berikut:
 - Tunggu hingga Nada Izin Bicara selesai dan bicaralah dengan jelas ke mikrofon, jika diaktifkan.
 - Tunggu hingga Sidetone **PTT** selesai dan bicaralah dengan jelas ke mikrofon, jika diaktifkan.



PEMBERITAHUAN:

Pengguna pada saluran ini tidak bisa menjawab Panggilan Suara Siaran.

Radio kembali ke menu sebelumnya setelah panggilan berakhir.

Melakukan Panggilan Suara Siaran Menggunakan Tombol Angka yang Dapat Diprogram

Ikuti prosedur untuk melakukan Panggilan Suara Siaran di radio Anda menggunakan tombol angka yang dapat diprogram.

- 1 Pada layar **Awal**, tekan lama tombol angka terprogram yang ditetapkan ke alias atau ID yang telah ditentukan.

Jika sebuah tombol angka dialokasikan untuk sebuah entri dalam mode tertentu, fitur ini tidak didukung apabila Anda menekan lama tombol angka dalam mode yang lain.

Jika tombol angka tidak dikaitkan ke suatu entri, akan terdengar bunyi nada indikator negatif.

- 2 Tekan tombol **PTT** untuk melakukan panggilan. LED hijau akan menyala.

Lihat [Mengalokasikan Entri ke Tombol Angka yang Dapat Diprogram di halaman 423](#) untuk informasi selengkapnya.



Melakukan Panggilan Suara Siaran Menggunakan Pencarian Alias

Ikuti prosedur untuk melakukan Panggilan Suara Siaran di radio Anda menggunakan pencarian alias.





- 1 Tekan  untuk mengakses menu.

- 2 Tekan  atau  ke Kontak. Tekan  untuk memilih.

Layar menampilkan entri sesuai urutan abjad.

- 3 Tekan  atau  ke alias atau ID subscriber yang diinginkan. Baris pertama layar menampilkan Nomor Telepon:. Baris kedua layar menampilkan kursor yang berkedip. Gunakan keypad untuk memasukkan nomor telepon.
-



- 4 Tekan  untuk memilih. Jika entri yang dipilih kosong, nada indikator negatif akan berbunyi dan layar menampilkan Panggilan Telepon Tidak Valid #.
-

- 5 Tekan  atau  ke Panggil Telepon dan Tekan  untuk memilih. Jika kode akses tidak dikonfigurasi sebelumnya dalam daftar Kontak, baris pertama pada layar menampilkan Kode Akses:. Baris kedua layar menampilkan kursor yang berkedip. Masukkan kode akses dan tekan tombol  untuk melanjutkan. Jika berhasil, nada DTMF terdengar. Nada panggilan dari pengguna telepon

akan terdengar. Baris pertama layar menampilkan alias atau ID subscriber, dan ikon RSSI. Baris kedua layar menampilkan Panggil Telepon dan ikon Panggilan Telepon. Jika tidak berhasil, nada terdengar dan layar menampilkan Panggilan Telepon Gagal. Radio Anda kembali ke layar input Kode Akses. Jika kode akses telah dikonfigurasi sebelumnya di daftar Kontak, radio akan kembali ke layar tempat Anda berada sebelum memulai panggilan.

- 6 Tekan tombol **PTT** untuk berbicara dan lepaskan untuk mendengarkan. Ikon RSSI tidak ditampilkan selama transmisi.
-
- 7 Untuk memasukkan digit ekstra, jika diminta oleh Panggilan Telepon, lakukan salah satu hal berikut.
- Tekan sembarang tombol keypad untuk mulai memasukkan digit ekstra. Baris pertama layar menampilkan Digit Ekstra:. Baris kedua layar menampilkan kursor yang berkedip. Masukkan digit ekstra dan tekan tombol  untuk melanjutkan. Nada DTMF terdengar dan radio kembali ke layar sebelumnya.

- Tekan tombol **Akses Satu Sentuhan**. Nada DTMF akan berbunyi. Jika entri untuk tombol **Akses Satu Sentuhan** kosong, nada indikator negatif akan berbunyi.



- 8 Tekan  untuk mengakhiri panggilan. Jika kode de-akses tidak dikonfigurasi sebelumnya dalam daftar Kontak, baris pertama layar akan menampilkan Kode De-Akses:. Baris kedua layar menampilkan kursor yang berkedip. Masukkan kode de-akses dan tekan  untuk melanjutkan. Radio kembali ke layar sebelumnya. Nada DTMF berbunyi dan layar menampilkan Mengakhiri Panggilan Telepon. Jika berhasil, nada terdengar dan layar menampilkan Panggilan Telepon Diakhiri. Radio Anda kembali ke layar Panggilan Telepon. Jika tidak berhasil, radio Anda kembali ke layar Panggilan Telepon. Jika Anda menekan tombol **PTT** saat berada di layar Kontak Telepon, nada akan berbunyi dan layar menampilkan Tekan OK untuk Melakukan Panggilan. Jika pengguna telepon mengakhiri panggilan, nada berbunyi dan layar menampilkan dan layar menampilkan Panggilan Telepon Diakhiri. Jika panggilan berakhir saat Anda memasukkan digit ekstra yang diminta oleh

Panggilan Telepon, radio kembali ke layar yang dibuka sebelum Anda memulai panggilan.



PEMBERITAHUAN:

Selama akses saluran, tekan  untuk menghentikan percobaan panggilan dan nada akan berbunyi atau untuk keluar dari pencarian alias.

Tekan tombol  atau  untuk keluar dari pencarian alias. Selama panggilan, saat Anda menekan tombol Akses Satu Sentuhan dengan kode de-akses yang dikonfigurasi sebelumnya atau memasukkan kode de-akses sebagai input untuk digit ekstra, radio akan mencoba mengakhiri panggilan. Saat mengakses saluran dan melakukan transmisi kode akses/de-akses atau digit ekstra, radio hanya merespons tombol On/Off, Kenop Volume, dan Pilih Saluran. Nada akan berbunyi untuk tiap input yang tidak valid.

Menerima Panggilan Suara Siaran

Apabila Anda menerima Panggilan Suara Siaran:

- Nada akan berbunyi.
- LED akan berkedip hijau.

- Layar menampilkan ikon **Panggilan Grup** di sudut kanan atas.
- Baris teks pertama menampilkan ID alias pemanggil.
- Baris teks kedua menampilkan Panggilan Siaran.
- Radio bersuara dan panggilan masuk berbunyi melalui speaker.

Jika panggilan berakhir, radio kembali ke layar sebelumnya.

Sebelum berakhir, Panggilan Suara Siaran tidak menunggu selama waktu yang telah ditentukan sebelumnya.

Anda tidak dapat merespons Panggilan Suara Siaran.



PEMBERITAHUAN:

Radio berhenti menerima Panggilan Suara Siaran tersebut jika Anda beralih ke saluran lain ketika menerima panggilan tersebut. Anda tidak dapat melanjutkan navigasi menu apa pun atau mengedit hingga Panggilan Suara Siaran berakhir.

Panggilan Tidak Dialamatkan

Panggilan Tidak Dialamatkan adalah panggilan grup ke salah satu dari 16 ID grup yang telah ditentukan sebelumnya.

Fitur ini dikonfigurasi menggunakan CPS-RM. Kontak untuk salah satu ID yang telah ditentukan diperlukan untuk memulai dan/atau menerima Panggilan Tidak Dialamatkan. Tanyakan kepada penyalur atau administrator sistem Anda untuk informasi lebih lanjut.

Melakukan Panggilan Tidak Dialamatkan

- 1 Pilih saluran dengan ID atau alias grup yang aktif.

 - 2 Tekan tombol **PTT** untuk melakukan panggilan. LED hijau akan menyala. Baris teks menampilkan Panggilan Tidak Dialamatkan, ikon **Panggilan Grup** dan alias.

 - 3 Lakukan salah satu langkah berikut:
 - Tunggu hingga Nada Izin Bicara selesai dan bicaralah dengan jelas ke mikrofon, jika diaktifkan.
 - Tunggu hingga Sidetone **PTT** selesai dan bicaralah dengan jelas ke mikrofon, jika diaktifkan.
-

- 4 Lepaskan tombol **PTT** untuk mendengarkan. LED hijau akan menyala jika radio target merespons. Nada sesaat berbunyi. Layar menampilkan Panggilan Tidak Dialamatkan, ikon dan alias atau ID **Panggilan Grup**, serta alias atau ID radio yang melakukan transmisi.
-

- 5 Jika fitur Indikasi Saluran Bebas diaktifkan, nada peringatan singkat akan berbunyi saat pengguna radio yang melakukan transmisi melepaskan tombol **PTT**, yang menunjukkan saluran bebas dapat Anda gunakan untuk merespons. Tekan tombol **PTT** untuk menjawab panggilan.

Panggilan berakhir jika tidak ada aktivitas suara selama waktu yang telah ditentukan.

Inisiator panggilan dapat menekan  untuk mengakhiri Panggilan Grup.

Merrespons Panggilan Tidak Dialamatkan

Apabila Anda menerima sebuah Panggilan Tidak Dialamatkan:

- LED akan berkedip hijau.
- Nada sesaat berbunyi.
- Baris teks menampilkan Panggilan Tidak Dialamatkan, alias pemanggil, dan alias panggilan grup.
- Radio bersuara dan panggilan masuk berbunyi melalui speaker.

1 Lakukan salah satu langkah berikut:

- Jika fitur Indikasi Saluran Bebas diaktifkan, nada peringatan singkat akan berbunyi saat pengguna radio yang melakukan transmisi melepaskan tombol **PTT**, yang menunjukkan saluran bebas dapat Anda gunakan untuk merespons. Tekan tombol **PTT** untuk menjawab panggilan.
- Jika Interupsi Suara diaktifkan, tekan tombol **PTT** untuk menginterupsi audio dari radio yang melakukan transmisi dan membebaskan saluran sehingga Anda dapat merespons.

LED hijau akan menyala.

2 Lakukan salah satu langkah berikut:

- Tunggu hingga Nada Izin Bicara selesai dan bicaralah dengan jelas ke mikrofon, jika diaktifkan.
- Tunggu hingga Sidetone **PTT** selesai dan bicaralah dengan jelas ke mikrofon, jika diaktifkan.

-
- 3** Lepaskan tombol **PTT** untuk mendengarkan. Panggilan berakhir jika tidak ada aktivitas suara selama waktu yang telah ditentukan.
-

Mode Saluran Suara Terbuka (OVCM)

Mode Saluran Suara Terbuka (OVCM) memungkinkan radio yang tidak dikonfigurasi sebelumnya untuk bekerja di sistem tertentu untuk menerima dan mengirim transmisi selama panggilan grup atau individu.

Panggilan grup OVCM juga mendukung panggilan siaran. Program radio untuk menggunakan fitur ini. Tanyakan kepada penyalur atau administrator sistem Anda untuk informasi lebih lanjut.

Melakukan Panggilan OVCM

Radio harus diprogram untuk melakukan Semua Panggilan. Ikuti prosedur untuk melakukan Panggilan OVCM di radio Anda.

- 1** Tekan tombol **PTT** untuk melakukan panggilan. LED hijau akan menyala. Baris teks ini menampilkan ikon jenis panggilan, **OVCM**, dan alias. Menandakan bahwa radio telah memasuki Status OVCM.

-
- 2** Lakukan salah satu langkah berikut:
 - Tunggu hingga Nada Izin Bicara selesai dan bicaralah dengan jelas ke mikrofon, jika diaktifkan.
 - Tunggu hingga Sidetone **PTT** selesai dan bicaralah dengan jelas ke mikrofon, jika diaktifkan.
-

Merespons Panggilan OVCM

Apabila Anda menerima sebuah Panggilan OVCM:

- LED akan berkedip hijau.

- Baris teks menampilkan ikon jenis panggilan, OVMC, dan alias.
- Radio bersuara dan panggilan masuk berbunyi melalui speaker.

1 Lakukan salah satu langkah berikut:

- Jika fitur Indikasi Saluran Bebas diaktifkan, nada peringatan singkat akan berbunyi saat pengguna radio yang melakukan transmisi melepaskan tombol **PTT**, yang menunjukkan saluran bebas dapat Anda gunakan untuk merespons. Tekan tombol **PTT** untuk menjawab panggilan.
- Jika Interupsi Suara diaktifkan, tekan tombol **PTT** untuk menginterupsi audio dari radio yang melakukan transmisi dan membebaskan saluran sehingga Anda dapat merespons.

LED hijau akan menyala.

2 Lakukan salah satu langkah berikut:

- Tunggu hingga Nada Izin Bicara selesai dan bicaralah dengan jelas ke mikrofon, jika diaktifkan.

- Tunggu hingga Sidetone **PTT** selesai dan bicaralah dengan jelas ke mikrofon, jika diaktifkan.

3 Lepaskan tombol **PTT** untuk mendengarkan.

Panggilan berakhir jika tidak ada aktivitas suara selama waktu yang telah ditentukan.

Fitur Lanjutan

Bab ini menjelaskan pengoperasian fitur-fitur yang terdapat di radio Anda.

Dealer atau administrator sistem mungkin telah mengatur radio sesuai dengan kebutuhan khusus Anda. Tanyakan kepada penyalur atau administrator sistem Anda untuk informasi lebih lanjut.

Pengingat Saluran Rumah

Fitur ini akan mengingatkan ketika radio tidak diatur ke saluran rumah selama jangka waktu tertentu.

Jika fitur ini diaktifkan melalui CPS, jika radio tidak diatur ke saluran rumah selama jangka waktu tertentu, hal berikut ini terjadi secara berkala:

- Nada Pengingat Saluran Rumah dan suara pengumuman berbunyi.
- Baris pertama layar menampilkan Non.
- Baris kedua menunjukkan Saluran Rumah.

Anda dapat merespons pengingat dengan melakukan salah satu tindakan berikut:

- Kembali ke saluran rumah.
- Matikan suara pengingat untuk sementara menggunakan tombol yang dapat diprogram.
- Buat saluran rumah baru menggunakan tombol yang dapat diprogram.

Mematikan Suara Pengingat Saluran Rumah

Ketika Pengingat Saluran Rumah berbunyi, Anda dapat mematikan suaranya.



Tekan tombol **Senyapkan Pengingat Saluran Rumah** yang dapat diprogram.



Baris pertama layar menampilkan HCR dan baris kedua menampilkan Disenyapkan.



Mengatur Saluran Rumah Baru





Jika Pengingat Saluran Rumah terjadi, Anda dapat menetapkan saluran rumah baru.

- 1 Lakukan salah satu langkah berikut:
 - Tekan tombol yang dapat diprogram **Atur Ulang Saluran Rumah** untuk mengatur saluran saat ini sebagai Saluran Rumah yang baru. Lompati langkah-langkah berikut ini. Baris pertama layar menampilkan alias saluran dan baris kedua menampilkan Saluran Rumah Baru.
 - Tekan  untuk mengakses menu.

- 2 Tekan  atau  ke Utilitas. Tekan  untuk memilih.

- 3 Tekan  atau  ke Pengaturan Radio. Tekan  untuk memilih.

4 Tekan  atau  ke Saluran Rumah. Tekan  untuk memilih.

5 Tekan  atau  ke alias saluran rumah baru yang diinginkan. Tekan  untuk memilih. Layar menampilkan  di sebelah alias saluran rumah yang dipilih.

Pemeriksaan Radio

Dengan fitur ini, Anda dapat menentukan jika radio lain sedang aktif di dalam sistem tanpa mengganggu pengguna radio. Tidak ada pemberitahuan suara atau visual yang tampil di radio target. Fitur ini hanya tersedia untuk alias atau ID subscriber. Radio harus diprogram agar Anda bisa menggunakan fitur ini.

Mengirim Pemeriksaan Radio

Ikuti prosedur untuk mengirim pemeriksaan radio di radio Anda.

1 Tekan tombol **Pemeriksaan Radio** terprogram.

2 Tekan  atau  ke alias atau ID yang diinginkan. Tekan  untuk memilih.

Layar menampilkan pemberitahuan mini transisional, yang menunjukkan permintaan sedang diproses. LED hijau akan menyala.

Tunggu respons.

Jika Anda menekan  ketika radio menunggu respons, sebuah nada berbunyi, radio mengakhiri semua percobaan ulang, dan keluar dari mode Pemeriksaan Radio.

Jika berhasil:

- Nada indikator positif akan berbunyi.
- Layar menampilkan pemberitahuan mini positif.

Jika tidak berhasil:



- Nada indikator negatif akan berbunyi.
- Layar menampilkan pemberitahuan mini negatif.



Radio kembali ke layar alias atau ID subscriber.



Mengirim Pemeriksaan Radio Menggunakan Panggilan Manual

Ikuti prosedur untuk mengirim pemeriksaan radio di radio Anda menggunakan panggilan manual.

- 1 Tekan  untuk mengakses menu.



- 2 Tekan  atau  ke Kontak. Tekan  untuk memilih.

- 3 Tekan  atau  ke Panggilan Manual. Tekan  untuk memilih.

- 4 Tekan  atau  ke Nomor Radio. Tekan  untuk memilih.

- 5 Lakukan salah satu langkah berikut:
 - Masukkan alias atau ID subscriber, lalu tekan  untuk melanjutkan.

- Edit ID yang dipanggil sebelumnya, lalu tekan  untuk melanjutkan.

- 6 Tekan  atau  ke Pemeriksaan Radio. Tekan  untuk memilih. Layar menampilkan pemberitahuan mini transisional, yang menunjukkan permintaan sedang diproses. LED hijau akan menyala.

- 7 Tunggu respons.

Jika  ditekan ketika radio menunggu penerimaan, sebuah nada berbunyi, dan radio mengakhiri semua percobaan ulang dan keluar dari mode Pemeriksaan Radio.

Jika berhasil:

 - Nada indikator positif akan berbunyi.
 - Layar menampilkan pemberitahuan mini positif.

Jika tidak berhasil:

 - Nada indikator negatif akan berbunyi.
 - Layar menampilkan pemberitahuan mini negatif.

Radio kembali ke layar alias atau ID subscriber.

Monitor Jarak Jauh

Fitur ini digunakan untuk mengaktifkan mikrofon radio target dengan alias atau ID subscriber. Anda dapat menggunakan fitur ini untuk memantau dari jauh aktivitas yang dapat didengar di sekitar radio target.

Ada dua jenis Monitor Jauh:

- Monitor Jauh tanpa Autentikasi
- Monitor Jauh dengan Autentikasi.

Fitur Monitor Jauh dengan Autentikasi dapat dibeli. Di Fitur Monitor Jauh dengan Autentikasi, verifikasi diperlukan saat radio Anda mengaktifkan mikrofon radio target.

Saat radio menerapkan fitur ini ke radio target dengan Autentikasi Pengguna, frasa sandi diperlukan. Frasa sandi sudah diprogram sebelumnya ke dalam radio target melalui CPS.

Radio Anda dan radio target harus diprogram agar Anda bisa menggunakan fitur ini.

Fitur ini otomatis berhenti setelah durasi yang telah diprogram atau bila radio target dioperasikan oleh pengguna.

Menginisiasi Monitor Jauh

Ikuti prosedur untuk mengaktifkan Monitor Jauh di radio Anda.

1 Tekan tombol **Monitor Jauh** terprogram.

2 Tekan  atau  ke alias atau ID yang diinginkan.

3 Tekan  untuk memilih. Salah satu skenario berikut ini akan terjadi:

- Layar menampilkan pemberitahuan mini transisional, yang menunjukkan permintaan sedang diproses. LED hijau akan menyala.
- Akan muncul layar frase sandi.

Masukkan frase sandi. Tekan  untuk melanjutkan.

- Jika frasa sandi benar, layar menampilkan pemberitahuan mini transisional, yang menunjukkan permintaan sedang diproses. LED hijau akan menyala.
- Jika frase sandi salah, layar menampilkan pemberitahuan mini negatif, dan Anda akan kembali ke layar sebelumnya.

4 Tunggu respons.

Jika berhasil:

- Nada indikator positif akan berbunyi.
- Layar menampilkan pemberitahuan mini positif.
- Audio dari radio yang dimonitor mulai memutar durasi terprogram dan layar menampilkan Mon. Jauh. Setelah pencatat waktu berakhir, nada peringatan akan berbunyi dan LED akan mati.



Jika tidak berhasil:



- Nada indikator negatif akan berbunyi.
 - Layar menampilkan pemberitahuan mini negatif.
-



Mengaktifkan Monitor Jauh Menggunakan Daftar Kontak

Ikuti prosedur untuk melakukan Monitor Jauh di radio Anda menggunakan daftar Kontak.

- 1 Tekan  untuk mengakses menu.

- 2 Tekan  atau  ke Kontak. Tekan  untuk memilih.

- 3 Tekan  atau  ke alias atau ID yang diinginkan. Tekan  untuk memilih.

- 4 Tekan  atau  ke Mon. Jauh.

- 5 Tekan  untuk memilih. Salah satu skenario berikut ini akan terjadi:
 - Layar menampilkan pemberitahuan mini transisional, yang menunjukkan permintaan sedang diproses. LED hijau akan menyala.
 - Akan muncul layar frase sandi.

Masukkan frase sandi. Tekan  untuk melanjutkan.

- Jika frasa sandi benar, layar menampilkan pemberitahuan mini transisional, yang menunjukkan permintaan sedang diproses. LED hijau akan menyala.
- Jika frase sandi salah, layar menampilkan pemberitahuan mini negatif, dan Anda akan kembali ke layar sebelumnya.

6 Tunggu respons.

Jika berhasil:

- Nada indikator positif akan berbunyi.
- Layar menampilkan pemberitahuan mini positif.
- Audio dari radio yang dimonitor mulai memutar durasi terprogram dan layar menampilkan Mon. Monitor. Setelah pencatat waktu berakhir, nada peringatan akan berbunyi dan LED akan mati.



Jika tidak berhasil:



- Nada indikator negatif akan berbunyi.
- Layar menampilkan pemberitahuan mini negatif.



Memulai Monitor Jauh Menggunakan Panggilan Manual

Ikuti prosedur untuk melakukan Monitor Jauh di radio Anda menggunakan panggilan manual.

- 1 Tekan  untuk mengakses menu.

- 2 Tekan  atau  ke Kontak. Tekan  untuk memilih.

- 3 Tekan  atau  ke Panggilan Manual. Tekan  untuk memilih.

- 4 Tekan  atau  ke Nomor Radio. Tekan  untuk memilih.

- 5 Lakukan salah satu langkah berikut:
 - Masukkan alias atau ID subscriber, lalu tekan  untuk melanjutkan.

- Edit ID yang dipanggil sebelumnya, lalu tekan  untuk melanjutkan.
-

6 Tekan  atau  ke Mon. Jauh.

7 Tekan  untuk memilih. Salah satu skenario berikut ini akan terjadi:

- Layar menampilkan pemberitahuan mini transisional, yang menunjukkan permintaan sedang diproses. LED hijau akan menyala.
- Akan muncul layar frase sandi.

Masukkan frase sandi. Tekan  untuk melanjutkan.

- Jika frasa sandi benar, layar menampilkan pemberitahuan mini transisional, yang menunjukkan permintaan sedang diproses. LED hijau akan menyala.
 - Jika frase sandi salah, layar menampilkan pemberitahuan mini negatif, dan Anda akan kembali ke layar sebelumnya.
-

8 Tunggu respons.

Jika berhasil:

- Nada indikator positif akan berbunyi.
- Layar menampilkan pemberitahuan mini positif.
- Audio dari radio yang dimonitor mulai memutar durasi terprogram dan layar menampilkan Mon. Jauh. Setelah pencatat waktu berakhir, nada peringatan akan berbunyi dan LED akan mati.

Jika tidak berhasil:

- Nada indikator negatif akan berbunyi.
 - Layar menampilkan pemberitahuan mini negatif.
-

Daftar Pindai

Daftar pindai dibuat dan ditetapkan di masing-masing saluran atau grup. Radio memindai aktivitas suara dengan beralih di antara urutan saluran atau grup yang ditentukan dalam daftar pemindaian untuk mengetahui saluran atau grup yang aktif.

Radio Anda dapat mendukung hingga 250 daftar pindai, dengan maksimal 16 anggota dalam daftar.

Setiap daftar pindai mendukung campuran entri analog dan digital.

Anda bisa menambahkan, menghapus, atau memprioritaskan saluran dengan mengedit daftar pindai.

Anda bisa menambahkan daftar pindai baru ke radio Anda menggunakan Pemrograman Panel Depan. Lihat [Konfigurasi Panel Depan di halaman 196](#) untuk informasi selengkapnya.

Ikon **Prioritas** muncul di kiri alias anggota, jika diatur, untuk menunjukkan apakah anggota ada di daftar saluran Prioritas 1 atau Prioritas 2. Anda tidak bisa memiliki banyak saluran Prioritas 1 atau Prioritas 2 di daftar pindai Anda. Tidak ada ikon **Prioritas** jika prioritas diatur ke **Tidak Ada**.



PEMBERITAHUAN:



Fitur ini tidak tersedia dalam Capacity Plus.

Melihat Entri dalam Daftar Pindai

Ikuti prosedur untuk melihat entri dalam daftar Pindai di radio Anda.

- 1 Tekan  untuk mengakses menu.
-

- 2 Tekan  atau  ke Pindai. Tekan  untuk memilih.
-

- 3 Tekan  atau  ke Daftar Pindai. Tekan  untuk memilih.
-



- 4 Tekan  atau  untuk melihat setiap anggota dalam daftar.
-

Melihat Entri dalam Daftar Pindai Menggunakan Pencarian Alias

Ikuti prosedur untuk melihat entri baru dalam daftar Pindai di radio Anda menggunakan pencarian alias.

- 1 Tekan  untuk mengakses menu.
-

- 2 Tekan  atau  ke Pindai. Tekan  untuk memilih.
-

3 Tekan  atau  ke Daftar Pindai. Tekan  untuk memilih.

4 Masukkan karakter pertama dari alias yang diinginkan.

Layar menampilkan kursor berkedip.

5 Masukkan sisa karakter dari alias yang diperlukan.

Pencarian alias peka terhadap huruf besar-kecil. Jika terdapat dua entri atau lebih dengan nama yang sama, layar akan menampilkan entri pertama yang tercantum dalam daftar.

Baris teks pertama menampilkan karakter yang Anda masukkan. Baris teks berikut ini menampilkan hasil pencarian daftar pendek.

Menambahkan Entri Baru ke Daftar Pindai

Ikuti prosedur untuk menambahkan entri baru ke dalam daftar Pindai di radio Anda.



1 Tekan  untuk mengakses menu.

2 Tekan  atau  ke Pindai. Tekan  untuk memilih.







3 Tekan  atau  ke Daftar Pindai. Tekan  untuk memilih.

4 Tekan  atau  ke Tambah Anggota. Tekan  untuk memilih.

5 Tekan  atau  ke alias atau ID yang diinginkan. Tekan  untuk memilih.





6 Tekan  atau  ke tingkat prioritas yang diperlukan. Tekan  untuk memilih.
Layar menampilkan pemberitahuan mini positif lalu, Tambah Lainnya?.



7 Lakukan salah satu langkah berikut:

- Tekan  atau  ke Ya untuk menambahkan entri lain. Tekan  untuk memilih. Ulangi [langkah 5](#) dan [langkah 6](#).
- Tekan  atau  ke Tidak untuk menyimpan daftar saat ini. Tekan  untuk memilih.

Menambahkan Entri Baru ke Daftar Pindai Menggunakan Pencarian Alias

Ikuti prosedur untuk menambahkan entri baru ke daftar Pindai di radio Anda menggunakan pencarian alias.

- 1 Tekan  untuk mengakses menu.
- 2 Tekan  atau  ke Pindai. Tekan  untuk memilih.



- 3 Tekan  atau  ke Daftar Pindai. Tekan  untuk memilih.

- 4 Tekan  atau  ke Tambah Anggota. Tekan  untuk memilih.







- 5 Masukkan karakter pertama dari alias yang diinginkan.
Layar menampilkan kursor berkedip.

- 6 Masukkan sisa karakter dari alias yang diperlukan.
Pencarian alias peka terhadap huruf besar-kecil. Jika terdapat dua entri atau lebih dengan nama yang sama, layar akan menampilkan entri pertama yang tercantum dalam daftar.
Baris teks pertama menampilkan karakter yang Anda masukkan. Baris teks berikut ini menampilkan hasil pencarian daftar pendek.

- 7 Tekan  untuk memilih.

8 Tekan  atau  ke tingkat prioritas yang diperlukan. Tekan  untuk memilih. Layar menampilkan pemberitahuan mini positif lalu, Tambah Lainnya?.

9 Lakukan salah satu langkah berikut:



- Tekan  atau  ke Ya untuk menambahkan entri lain. Tekan  untuk memilih. Ulangi langkah [langkah 5](#) hingga Langkah [langkah 8](#).
 - Tekan  atau  ke Tidak untuk menyimpan daftar saat ini. Tekan  untuk memilih.
-

Menghapus Entri dari Daftar Pindai



Ikuti prosedur untuk menghapus entri dari daftar Pindai.

1 Tekan  untuk mengakses menu.



2 Tekan  atau  ke Pindai. Tekan  untuk memilih.

3 Tekan  atau  ke Daftar Pindai. Tekan  untuk memilih.

4 Tekan  atau  ke alias atau ID yang diinginkan. Tekan  untuk memilih.

5 Tekan  atau  ke Hapus. Tekan  untuk memilih. Layar menampilkan Hapus Entri?.

6 Lakukan salah satu langkah berikut:

- Tekan  atau  ke Ya untuk menghapus entri. Tekan  untuk memilih. Layar menampilkan pemberitahuan mini positif.

- Tekan  atau  ke Tidak untuk kembali ke layar sebelumnya. Tekan  untuk memilih.

7 Ulangi langkah 4 hingga langkah 6 untuk menghapus entri lain.



8 Tekan lama  untuk kembali ke layar Awal setelah menghapus alias atau ID yang diinginkan.



Menetapkan Prioritas untuk Entri dalam Daftar Pindai

Ikuti prosedur untuk menentukan prioritas bagi entri dalam daftar Pindai di radio Anda.

1 Tekan  untuk mengakses menu.

2 Tekan  atau  ke Pindai. Tekan  untuk memilih.

3 Tekan  atau  ke Daftar Pindai. Tekan  untuk memilih.

4 Tekan  atau  ke alias atau ID yang diinginkan. Tekan  untuk memilih.

5 Tekan  atau  ke Edit Prioritas. Tekan  untuk memilih.

6 Tekan  atau  ke tingkat prioritas yang diperlukan. Tekan  untuk memilih.

Layar menampilkan pemberitahuan mini positif sebelum kembali ke layar sebelumnya. Ikon **Prioritas** muncul di sebelah kiri alias anggota.

Pemindaian

Radio akan menggulir daftar penelusuran yang telah diprogram pada saluran aktif untuk mencari aktivitas suara ketika Anda menjalankan pemindaian.

**PEMBERITAHUAN:**

Fitur ini tidak tersedia dalam Capacity Plus.

Selama pemindaian mode ganda, jika Anda berada pada saluran digital, dan radio menangkap saluran analog, radio secara otomatis beralih dari mode digital ke mode analog selama durasi panggilan. Demikian juga sebaliknya.

Ada dua cara memulai pemindaian:

Pemindaian Saluran Utama (Manual)

Radio memindai semua saluran atau grup dalam daftar penelusuran. Setelah mulai memindai, bergantung pada pengaturannya, radio mungkin secara otomatis memulai pada saluran/grup aktif yang dipindai terakhir kali atau pada saluran tempat pemindaian dimulai.

Pemindaian Otomatis

Radio secara otomatis mulai memindai jika Anda memilih saluran atau grup dengan Pemindaian Otomatis diaktifkan.



**PEMBERITAHUAN:**



Saat Anda mengonfigurasi **Terima Pesan Grup dalam Pindaian**, radio Anda dapat menerima pesan grup dari saluran non-rumah. Radio Anda dapat membalas pesan grup di saluran rumah tetapi tidak dapat membalas di saluran non-rumah. Tanyakan kepada penyalur atau administrator sistem Anda untuk informasi lebih lanjut.



Mengaktifkan atau Menonaktifkan Pemindaian

Ikuti prosedur untuk mengaktifkan atau menonaktifkan pemindaian di radio Anda.

- 1 Tekan  untuk mengakses menu.

- 2 Tekan  atau  ke Pindai. Tekan  untuk memilih.

- 3 Tekan  atau  ke Status Pemindaian. Tekan  untuk memilih.

- 4 Tekan  atau  ke status pemindaian yang diperlukan dan tekan  untuk memilih.

Jika pemindaian diaktifkan:

- Layar menampilkan ikon Pemindaian Aktif dan **Pindai**.
- LED kuning akan berkedip.

Jika pemindaian dinonaktifkan:

- Layar akan menampilkan Pemindaian Nonaktif.
- Ikon **Pindai** tidak muncul.
- LED mati.

Merespons Transmisi Selama Pemindaian

Selama pemindaian, radio berhenti pada saluran/grup tempat aktivitas terdeteksi. Radio tetap berada di saluran tersebut selama durasi terprogram, yang disebut waktu hang. Ikuti prosedur untuk merespons transmisi selama pemindaian.

- 1  Jika fitur Indikasi Saluran Bebas diaktifkan, nada peringatan singkat akan berbunyi saat pengguna radio yang melakukan transmisi melepaskan tombol **PTT**, yang menunjukkan saluran bebas dapat Anda gunakan untuk merespons. Tekan tombol **PTT** selama waktu hang.

LED hijau akan menyala.

- 2 Lepaskan tombol **PTT** untuk mendengarkan.

Radio kembali memindai saluran atau grup lain jika Anda tidak merespons selama waktu hang.

Menghapus Saluran Gangguan

Jika saluran terus menghasilkan kebisingan atau panggilan yang tidak diinginkan (disebut dengan saluran "gangguan"), Anda dapat menghapus saluran yang tidak diinginkan tersebut untuk sementara dari daftar penelusuran. Kemampuan ini tidak berlaku bagi saluran yang ditetapkan sebagai Saluran Terpilih. Ikuti prosedur untuk menghapus saluran gangguan di radio Anda.

- 1 Bila radio menangkap saluran yang tidak dikehendaki atau saluran gangguan, tekan tombol terprogram **Hapus Saluran Gangguan** sampai Anda mendengar sebuah nada.
 - 2 Lepaskan tombol **Hapus Saluran Gangguan** terprogram.
Saluran gangguan dihapus.
-

Memulihkan Saluran Gangguan

Ikuti prosedur untuk memulihkan saluran gangguan di radio Anda.

Lakukan salah satu langkah berikut:

- Matikan radio, lalu hidupkan kembali.
- Hentikan dan mulai lagi pemindaian menggunakan menu atau tombol **Pindai** terprogram.
- Ganti saluran menggunakan tombol **Saluran Naik/Turun**.

Vote Scan

Vote Scan menyediakan jangkauan area yang luas bagi Anda dalam area di mana terdapat beberapa stasiun pangkalan yang mentransmisikan informasi yang identik pada saluran analog berlainan.

Radio memindai saluran-saluran analog dari beberapa stasiun pangkalan dan melakukan proses voting untuk memilih sinyal yang paling kuat diterima. Setelah sinyal itu ditetapkan, radio Anda menerima transmisi dari stasiun pangkalan tersebut.

Selama vote scan, LED kuning berkedip dan layar menampilkan ikon **Vote Scan**.

Ikuti prosedur yang sama dengan [Merespons Transmisi Selama Pemindaian di halaman 419](#), untuk merespons transmisi selama vote scan.

Pengaturan Kontak

Kontak mempunyai kemampuan seperti buku telepon di radio Anda. Setiap entri berhubungan dengan suatu alias atau ID yang Anda gunakan untuk memulai panggilan. Entri diurutkan berdasar abjad.

Bergantung konteksnya, tiap entri terkait dengan jenis panggilan yang berbeda: Panggilan Grup, Panggilan Pribadi, Semua Panggilan, Panggilan PC, atau Panggilan Dispatch.

Panggilan PC dan Panggilan Dispatch terkait dengan data. Ini hanya tersedia dengan aplikasi. Untuk detail selengkapnya, lihat dokumentasi aplikasi data.

 Selain itu, melalui menu Kontak, Anda dapat menetapkan tiap entri ke satu atau beberapa tombol angka yang dapat diprogram pada mikrofon keypad. Jika ada entri yang ditentukan ke tombol angka, radio dapat melakukan sambungan cepat pada entri itu.

**PEMBERITAHUAN:**

Tanda centang akan ditampilkan di depan setiap tombol angka yang ditetapkan ke entri tertentu. Jika tanda centang muncul di depan **Kosong**, berarti Anda belum menetapkan tombol angka ke entri apa pun.

Masing-masing entri dalam Kontak menampilkan informasi berikut ini:

- Jenis Panggilan
- Alias Panggilan
- ID Panggilan



**PEMBERITAHUAN:**



Jika fitur Privasi telah diaktifkan di suatu saluran, Anda bisa melakukan Panggilan Grup dengan privasi aktif, Panggilan Pribadi, dan Semua Panggilan di saluran itu. Hanya radio target dengan Kunci Privasi yang sama, atau Nilai Kunci dan ID Kunci yang sama dengan radio Anda yang bisa mendekripsi transmisi tersebut.

Melakukan Panggilan Grup Menggunakan Daftar Kontak

Ikuti prosedur untuk melakukan Panggilan Grup di radio Anda menggunakan daftar Kontak.

- 1 Tekan  untuk mengakses menu.

- 2 Tekan  atau  ke Kontak. Tekan  untuk memilih.

- 3 Tekan  atau  ke alias atau ID yang diinginkan. Tekan  untuk memilih.

- 4 Tekan tombol **PTT** untuk melakukan panggilan. LED hijau akan menyala.







- 5 Lepaskan tombol **PTT** untuk mendengarkan. LED hijau berkedip ketika ada pengguna dalam grup yang merespons. Layar menampilkan ikon dan alias atau ID **Panggilan Grup**, serta alias atau ID radio yang melakukan transmisi.

- 6  Jika fitur Indikasi Saluran Bebas diaktifkan, nada peringatan singkat akan berbunyi saat pengguna radio yang melakukan transmisi melepaskan tombol **PTT**, yang menunjukkan saluran bebas dapat Anda gunakan untuk merespons. Tekan tombol **PTT** untuk menjawab panggilan.

Panggilan berakhir jika tidak ada aktivitas suara selama waktu yang telah ditentukan.

Melakukan Panggilan Pribadi Menggunakan Daftar Kontak

Ikuti prosedur untuk melakukan Panggilan Pribadi di radio Anda menggunakan daftar Kontak.

- 1 Tekan  untuk mengakses menu.
- 2 Tekan  atau  ke Kontak. Tekan  untuk memilih.
- 3 Tekan  atau  ke alias atau ID yang diinginkan. Tekan  untuk memilih.

- 4 Tekan tombol **PTT** untuk melakukan panggilan. LED hijau akan menyala. Layar menampilkan alias tujuan.

- 5 Tunggu hingga Nada Izin Bicara selesai dan bicaralah dengan jelas ke mikrofon, jika diaktifkan.

- 6 Lepaskan tombol **PTT** untuk mendengarkan. LED hijau akan berkedip jika radio target merespons. Layar akan menampilkan alias atau ID pengguna yang melakukan transmisi.



- 7  Jika fitur Indikasi Saluran Bebas diaktifkan, nada peringatan singkat akan berbunyi saat pengguna radio yang melakukan transmisi melepaskan tombol **PTT**, yang menunjukkan saluran bebas dapat Anda gunakan untuk merespons. Tekan tombol **PTT** untuk menjawab panggilan.



Panggilan berakhir jika tidak ada aktivitas suara selama waktu yang telah ditentukan. Nada akan berbunyi. Layar menampilkan pesan Panggilan Diakhiri.



Mengalokasikan Entri ke Tombol Angka yang Dapat Diprogram

Ikuti prosedur untuk mengalokasikan entri ke tombol angka yang dapat diprogram pada radio Anda.

- 1 Tekan  untuk mengakses menu.

- 2 Tekan  atau  ke Kontak. Tekan  untuk memilih.

- 3 Tekan  atau  ke alias atau ID yang diinginkan. Tekan  untuk memilih.



- 4 Tekan  atau  ke Tombol Program. Tekan  untuk memilih.

- 5 Lakukan salah satu langkah berikut:
 - Jika tombol angka yang diinginkan belum dialokasikan untuk sebuah entri, tekan 

atau  ke tombol angka yang diinginkan.



Tekan  untuk memilih.

- Jika tombol angka yang diinginkan sudah dialokasikan untuk sebuah entri, layar menampilkan Tombol Sudah Dialokasikan dan baris teks pertama menampilkan Timpa?. Lakukan salah satu langkah berikut:

Tekan  atau  ke Ya. Tekan  untuk memilih.

Radio membunyikan nada indikator positif dan layar menampilkan Kontak Disimpan serta pemberitahuan mini positif.

Tekan  atau  ke Tidak untuk kembali ke langkah sebelumnya.

Setiap entri dapat dikaitkan ke berbagai tombol angka. Anda melihat  sebelum tiap tombol angka yang dialokasikan pada entri. Jika  terdapat sebelum Kosong, maka tombol angka tidak ditetapkan.

Jika sebuah tombol angka dialokasikan untuk sebuah entri dalam mode tertentu, fitur ini tidak

didukung apabila Anda menekan lama tombol angka dalam mode yang lain.

Layar kembali ke menu sebelumnya secara otomatis.

Menghapus Kaitan Antara Entri dan Tombol Angka yang Dapat Diprogram



Ikuti prosedur untuk menghapus kaitan antara entri dan tombol angka yang dapat diprogram pada radio Anda.

- 1 Lakukan salah satu langkah berikut:
 - Tekan lama tombol angka terprogram ke alias atau ID yang diinginkan. Lanjutkan ke [langkah 4](#).
 - Tekan untuk mengakses menu.

-
- 2 Tekan atau ke Kontak. Tekan untuk memilih.

-
- 3 Tekan atau ke alias atau ID yang diinginkan. Tekan untuk memilih.

-
- 4 Tekan atau ke Tombol Program. Tekan untuk memilih.

-
- 5 Tekan atau ke Kosongan. Tekan untuk memilih.

Baris teks pertama menampilkan Hapus dari semua tombol.

-
- 6 Tekan atau ke Ya. Tekan untuk memilih.



PEMBERITAHUAN:

Bila salah satu entri dihapus, kaitan antara entri tersebut dan tombol angka terprogram juga akan dihapus.



Nada indikator positif akan berbunyi. Layar akan menampilkan Kontak Disimpan.



Layar kembali ke menu sebelumnya secara otomatis.



Menambahkan Kontak Baru

Ikuti prosedur untuk menambahkan kontak baru di radio Anda.

- 1 Tekan  untuk mengakses menu.



- 2 Tekan  atau  ke Kontak. Tekan  untuk memilih.

- 3 Tekan  atau  ke Kontak Baru. Tekan  untuk memilih.

- 4 Tekan  atau  untuk memilih jenis kontak Kontak Radio atau Kontak Telepon. Tekan  untuk memilih.

- 5 Masukkan nomor kontak dengan keypad, lalu tekan  untuk melanjutkan.



- 6 Masukkan nama kontak dengan keypad, lalu tekan  untuk melanjutkan.



- 7 Tekan  atau  ke jenis dering yang diinginkan. Tekan  untuk memilih. Nada indikator positif akan berbunyi. Layar menampilkan pemberitahuan mini positif.





Mengatur Kontak Default

Ikuti prosedur untuk menentukan kontak default di radio Anda.

- 1 Tekan  untuk mengakses menu.

- 2 Tekan  atau  ke Kontak. Tekan  untuk memilih.

- 3 Tekan  atau  ke alias atau ID yang diinginkan. Tekan  untuk memilih.

- 4 Tekan  atau  ke Tetapkan sebagai Default. Tekan  untuk memilih.
Nada indikator positif akan berbunyi. Layar menampilkan pemberitahuan mini positif. Layar menampilkan  di sebelah alias atau ID yang dipilih.



Pengaturan Indikator Panggilan



Fitur ini memungkinkan pengguna radio mengonfigurasi panggilan atau pesan teks yang menderingkan nada.



Mengaktifkan atau Menonaktifkan Dering Panggilan untuk Peringatan Panggilan



Ikuti prosedur untuk mengaktifkan atau menonaktifkan dering panggilan untuk Peringatan Panggilan di radio Anda.



- 1 Tekan  untuk mengakses menu.



- 2 Tekan  atau  ke Utilitas. Tekan  untuk memilih.

- 3 Tekan  atau  ke Pengaturan Radio. Tekan  untuk memilih.

- 4 Tekan  atau  ke Nada/Peringatan. Tekan  untuk memilih.







- 5 Tekan  atau  ke Dering Panggilan. Tekan  untuk memilih.

- 6 Tekan  atau  ke Peringatan Panggilan. Tekan  untuk memilih.

- 7 Tekan  atau  ke nada yang diinginkan.
Tekan  untuk memilih. Layar menampilkan ✓ di sebelah nada yang dipilih.
-



Mengaktifkan atau Menonaktifkan Dering Panggilan untuk Panggilan Pribadi



Ikuti prosedur untuk mengaktifkan atau menonaktifkan dering panggilan untuk Panggilan Pribadi di radio Anda.

- 1 Tekan  untuk mengakses menu.
-
- 2 Tekan  atau  ke **Utilitas**. Tekan  untuk memilih.
-
- 3 Tekan  atau  ke **Pengaturan Radio**. Tekan  untuk memilih.
-

- 4 Tekan  atau  ke **Nada/Peringatan**.
Tekan  untuk memilih.
-

- 5 Tekan  atau  ke **Dering Panggilan**.
Tekan  untuk memilih.
-



- 6 Tekan  atau  ke **Panggilan Pribadi**.
Tekan  untuk memilih.
Layar menampilkan ✓ di sebelah **Aktif** jika nada dering Panggilan Pribadi diaktifkan.
Layar menampilkan ✓ di sebelah **Nonaktif** jika nada dering Panggilan Pribadi dinonaktifkan.
-



- 7 Tekan  atau  ke nada yang diinginkan.
Tekan  untuk memilih.
Jika diaktifkan, ✓ muncul di sebelah **Diaktifkan**. Jika dinonaktifkan, ✓ hilang dari sebelah **Diaktifkan**.
-



Mengaktifkan atau Menonaktifkan Dering Panggilan untuk Panggilan Selektif



Ikuti prosedur untuk mengaktifkan atau menonaktifkan dering panggilan untuk Panggilan Selektif di radio Anda.





- 1 Tekan  untuk mengakses menu.





- 2 Tekan  atau  ke Utilitas. Tekan  untuk memilih.

- 3 Tekan  atau  ke Pengaturan Radio. Tekan  untuk memilih.

- 4 Tekan  atau  ke Nada/Peringatan. Tekan  untuk memilih.

- 5 Tekan  atau  ke Dering Panggilan. Tekan  untuk memilih.



- 6 Tekan  atau  ke Panggilan Selektif. Tekan  untuk memilih. Layar menampilkan  dan nada saat ini.

- 7 Tekan  atau  ke nada yang diinginkan. Tekan  untuk memilih. Layar menampilkan  di sebelah nada yang dipilih.

Mengaktifkan atau Menonaktifkan Dering Panggilan untuk Pesan Teks

Ikuti prosedur untuk mengaktifkan atau menonaktifkan dering panggilan pesan teks di radio Anda.

- 1 Tekan  untuk mengakses menu.

- 2 Tekan  atau  ke Utilitas. Tekan  untuk memilih.

3 Tekan  atau  ke Pengaturan Radio.

Tekan  untuk memilih.

4 Tekan  atau  ke Nada/Peringatan.

Tekan  untuk memilih.

5 Tekan  atau  ke Dering Panggilan.

Tekan  untuk memilih.

6 Tekan  atau  ke Pesan Teks. Tekan  untuk memilih.

Layar menampilkan  dan nada saat ini.

7 Tekan  atau  ke nada yang diinginkan.

Tekan  untuk memilih.

Layar menampilkan  di sebelah nada yang baru dipilih.

Mengaktifkan atau Menonaktifkan Dering Panggilan untuk Status Telemetri dengan Teks

Ikuti prosedur untuk mengaktifkan atau menonaktifkan dering panggilan untuk status telemetri dengan teks di radio Anda.

1 Tekan  untuk mengakses menu.

2 Tekan  atau  ke Utilitas. Tekan  untuk memilih.

3 Tekan  atau  ke Pengaturan Radio. Tekan  untuk memilih.

4 Tekan  atau  ke Nada/Peringatan. Tekan  untuk memilih.







5 Tekan  atau  ke Dering Panggilan. Tekan  untuk memilih.

- 6 Tekan  atau  ke Telemetri. Tekan  untuk memilih.



Zona saat ini akan ditandai dengan .





Menetapkan Gaya Dering

Radio bisa diprogram agar membunyikan salah satu dari sebelas nada dering ketika menerima Panggilan Pribadi, Peringatan Panggilan, atau Pesan Teks dari kontak tertentu. Radio membunyikan setiap gaya dering ketika Anda menelusuri daftar ini. Ikuti prosedur untuk mengalokasikan gaya dering di radio Anda.

- 1 Tekan  untuk mengakses menu.
- 2 Tekan  atau  ke Kontak. Tekan  untuk memilih.
Entri diurutkan berdasar abjad.
- 3 Tekan  atau  ke alias atau ID yang diinginkan. Tekan  untuk memilih.

- 4 Tekan  atau  ke Lihat/Edit. Tekan  untuk memilih.

- 5 Tekan  hingga layar menampilkan menu Dering.
Tanda  menunjukkan nada yang dipilih saat ini.

- 6 Tekan  atau  ke nada yang diinginkan.
Tekan  untuk memilih.
 muncul di samping nada yang dipilih.

Volume Nada Alarm yang Semakin Tinggi

Radio dapat diprogram untuk terus memberitahukan bila terdapat panggilan radio yang tidak terjawab. Hal ini dilakukan dengan otomatis meningkatkan volume nada alarm secara berkala. Fitur ini disebut Escalart.

Fitur Log Panggilan

Radio Anda terus mencatat semua Panggilan Pribadi keluar, yang dijawab, dan yang tidak terjawab. Fitur log panggilan digunakan untuk melihat dan mengelola panggilan terbaru.



Peringatan Panggilan Tak Terjawab dapat disertakan dapat log panggilan, tergantung konfigurasi sistem di radio Anda. Anda dapat melakukan tugas berikut ini di masing-masing daftar panggilan Anda:



- Menyimpan Alias atau ID ke Kontak
- Hapus Panggilan
- Menghapus Semua Panggilan
- Lihat Detail

Melihat Panggilan Terbaru

Ikuti prosedur untuk melihat panggilan terbaru di radio Anda.



- 1 Tekan  untuk mengakses menu.
-

- 2 Tekan  atau  ke Log Panggilan. Tekan  untuk memilih.
-

- 3 Tekan  atau  ke daftar yang diinginkan. Opsi yang tersedia adalah daftar Tak Terjawab, Terjawab, dan Keluar.

Tekan  untuk memilih.

Layar akan menampilkan entri paling kini.



- 4 Tekan  atau  untuk melihat daftar. Anda dapat memulai panggilan dengan alias atau ID yang sedang ditampilkan layar dengan menekan tombol **PTT** .
-

Menghapus Panggilan dari Daftar Panggilan

Ikuti prosedur untuk menghapus panggilan dari daftar Panggilan.



1 Tekan  untuk mengakses menu.



2 Tekan  atau  ke Log Panggilan. Tekan  untuk memilih.

3 Tekan  atau  ke daftar yang diinginkan. Tekan  untuk memilih.

Jika daftar kosong:

- Nada akan berbunyi.
 - Layar menampilkan Daftar Kosong.
-

4 Tekan  atau  ke alias atau ID yang diinginkan. Tekan  untuk memilih.

5 Tekan  atau  ke Hapus Entri?. Tekan  untuk memilih.

6 Lakukan salah satu langkah berikut:

- Tekan  untuk memilih Ya untuk menghapus entri.

Layar menampilkan Entri Dihapus.

- Tekan  atau  ke Tidak. Tekan  untuk memilih.



Radio kembali ke layar sebelumnya.



Menampilkan Detail Daftar Panggilan



Ikuti prosedur untuk melihat detail panggilan di radio.

1 Tekan  untuk mengakses menu.

2 Tekan  atau  ke Log Panggilan. Tekan  untuk memilih.

3 Tekan  atau  ke daftar yang diinginkan. Tekan  untuk memilih.

4 Tekan  atau  ke alias atau ID yang diinginkan. Tekan  untuk memilih.



5 Tekan  atau  ke Lihat Detail. Tekan  untuk memilih.
Layar menampilkan detail panggilan.

Menyimpan Alias atau ID dari Daftar Panggilan



Ikuti prosedur untuk menyimpan alias atau ID di radio Anda dari Daftar Panggilan.

1 Tekan  untuk mengakses menu.

2 Tekan  atau  ke Log Panggilan. Tekan  untuk memilih.

3 Tekan  atau  ke daftar yang diinginkan. Tekan  untuk memilih.

4 Tekan  atau  ke alias atau ID yang diinginkan. Tekan  untuk memilih.

5 Tekan  atau  ke Simpan. Tekan  untuk memilih.
Layar menampilkan kursor berkedip.

6 Masukkan sisa karakter dari alias yang diperlukan. Tekan  untuk memilih.
Anda dapat menyimpan ID tanpa alias.
Layar menampilkan pemberitahuan mini positif.

Operasi Peringatan Panggilan

Paging Peringatan Panggilan memungkinkan Anda mengingatkan seorang pengguna radio tertentu untuk menghubungi Anda kembali.

Fitur ini hanya tersedia untuk alias atau ID subscriber dan dapat diakses melalui menu menggunakan Kontak, panggilan manual, atau tombol terprogram **Akses Satu Sentuhan**.

Melakukan Peringatan Panggilan

Ikuti prosedur untuk melakukan Peringatan Panggilan di radio Anda.

- 1 Tekan tombol **Akses Satu Sentuhan** terprogram.

Layar menampilkan Peringatan Panggilan dan alias atau ID subscriber. LED hijau akan menyala.

- 2 Tunggu respons.

Jika respons Peringatan Panggilan diterima, layar akan menampilkan pemberitahuan mini positif.

Jika respons Peringatan Panggilan tidak diterima, layar akan menampilkan pemberitahuan mini negatif.



Membuat Peringatan Panggilan Menggunakan Daftar Kontak

Ikuti prosedur untuk melakukan Peringatan Panggilan di radio Anda menggunakan daftar Kontak.

- 1 Tekan  untuk mengakses menu.
-

- 2 Tekan  atau  ke Kontak. Tekan  untuk memilih.
-

- 3 Tekan  atau  ke alias atau ID yang diinginkan. Tekan  untuk memilih.
-

- 4 Tekan  atau  ke Peringatan Panggilan. Tekan  untuk memilih.

Layar menampilkan Peringatan Panggilan dan alias atau ID subscriber. LED hijau akan menyala.

5 Tunggu respons.

- Jika respons Peringatan Panggilan diterima, layar akan menampilkan pemberitahuan mini positif.
 - Jika respons Peringatan Panggilan tidak diterima, layar akan menampilkan pemberitahuan mini negatif.
-

Membuat Peringatan Panggilan Menggunakan Panggilan Manual

Ikuti prosedur untuk melakukan Peringatan Panggilan di radio Anda menggunakan panggilan manual.

1 Tekan  untuk mengakses menu.

2 Tekan  atau  ke Kontak. Tekan  untuk memilih.

3 Tekan  atau  ke Panggilan Manual.

Tekan  untuk memilih.

Layar menampilkan kursor berkedip.

4 Masukkan ID subscriber dan tekan  untuk melanjutkan.

5 Tekan  atau  ke Peringatan Panggilan.

Tekan  untuk memilih.

Layar menampilkan Peringatan Panggilan dan alias atau ID subscriber. LED hijau akan menyala.

6 Tunggu respons.

- Jika respons Peringatan Panggilan diterima, layar akan menampilkan pemberitahuan mini positif.
 - Jika respons Peringatan Panggilan tidak diterima, layar akan menampilkan pemberitahuan mini negatif.
-

Merespons Peringatan Panggilan

Ikuti prosedur untuk merespons Alarm Panggilan di radio Anda.

Ketika Anda menerima Peringatan Panggilan:

- Nada berulang akan berbunyi.
- LED kuning akan berkedip.
- Layar menampilkan daftar notifikasi yang berisi Peringatan Panggilan dengan alias atau ID radio pemanggil.

Tergantung konfigurasi oleh dealer atau administrator sistem, Anda dapat merespons Peringatan Panggilan dengan melakukan salah satu hal berikut:

- Tekan tombol **PTT** dan respons dengan Panggilan Pribadi secara langsung ke pemanggil.
- Tekan tombol **PTT** untuk melanjutkan komunikasi grup bicara normal.
Peringatan Panggilan dipindahkan ke opsi Panggilan Tak Terjawab di menu Log. Anda dapat merespons pemanggil dari log Panggilan Tak Terjawab.

Lihat [Daftar Notifikasi di halaman 194](#) dan [Fitur Log Panggilan di halaman 132](#) untuk informasi selengkapnya.

Mode Bisu

Mode Bisu memungkinkan pengguna untuk membisukan semua indikator audio di radio.

Setelah Mode Bisu aktif, semua indikator audio dibisukan, kecuali fitur dengan prioritas lebih tinggi misalnya Operasi darurat.

Setelah keluar dari Mode Bisu, radio melanjutkan pemutaran nada dan transmisi audio.



PEMBERITAHUAN:

Fitur ini dapat dibeli. Tanyakan kepada penyalur atau administrator sistem Anda untuk informasi lebih lanjut.

Mengaktifkan Mode Bisu

Ikuti prosedur untuk menonaktifkan Mode Bisu.

Akses fitur ini menggunakan tombol **Mode Bisu** terprogram.

Hal berikut mungkin terjadi saat Mode bisu aktif:

- Nada Indikator Positif Akan Berbunyi.
- Layar menampilkan Mode Bisu Aktif.
- Lampu LED berwarna merah akan terus berkedip hingga Anda keluar dari Mode Bisu.
- Layar menampilkan ikon **Mode Bisu** di layar utama.
- Radio dibisukan.
- Pewaktu Mode Bisu mulai menghitung mundur dengan durasi yang dikonfigurasi.

Menyetel Pewaktu Mode Bisu

Fitur Mode Bisu dapat diaktifkan dalam waktu yang telah dikonfigurasi terlebih dahulu dengan menyetel Pewaktu Mode Bisu. Durasi pewaktu dikonfigurasi di menu radio dengan rentang antara 0,5–6 jam. Anda akan dikeluarkan dari Mode Bisu setelah pewaktu kedaluwarsa.



Jika pewaktu habis pada angka 0, radio tetap berada dalam Mode bisu selama waktu yang tidak ditentukan hingga tombol **Mode Bisu** terprogram ditekan.

- 1 Tekan  untuk mengakses menu.
-

- 2 Tekan  atau  ke Utilitas. Tekan  untuk memilih.
-

- 3 Tekan  atau  ke Pengaturan Radio. Tekan  untuk memilih.
-

- 4 Tekan  atau  ke Pewaktu Mode Bisu. Tekan  untuk memilih.
-

- 5 Tekan  atau  untuk mengedit nilai angka setiap digit, lalu tekan .
-

Keluar dari Mode Bisu

Fitur ini dapat dikeluarkan secara otomatis setelah Pewaktu Mode Bisu kedaluwarsa.

Lakukan salah satu hal berikut untuk keluar dari Mode bisu secara manual:

- Tekan tombol **Mode Bisu** terprogram.

- Tekan tombol **PTT** pada entri apa pun.

Hal berikut akan terjadi saat Mode bisu nonaktif:

- Nada Indikator Negatif Akan Berbunyi.
- Layar menampilkan Mode Bisu Nonaktif.
- Lampu LED berwarna merah mati.
- Ikon **Mode Bisu** hilang dari layar utama.
- Radio menghidupkan suara dan status speaker dipulihkan.
- Jika pewaktu belum kedaluwarsa, Pewaktu mode bisu dihentikan.



PEMBERITAHUAN:

Pengguna juga dikeluarkan dari Mode Bisu jika mengirimkan suara atau beralih ke saluran yang belum terprogram.

Pengoperasian Darurat

Alarm Darurat digunakan untuk menunjukkan situasi genting. Anda dapat menginisiasi keadaan Darurat setiap saat, walaupun terdapat aktivitas pada saluran aktif.

Dealer Anda bisa mengatur durasi penekanan tombol untuk tombol **Darurat** yang terprogram, kecuali untuk

penekanan lama, yang sama dengan semua tombol lainnya:

Tekan Sebentar

Durasi antara 0,05 hingga 0,75 detik.

Tekan Lama

Durasi antara 1,00 hingga 3,75 detik.

Tombol **Darurat** ditetapkan ke fitur Darurat Aktif/Tidak Aktif. Tanyakan kepada dealer tentang pengoperasian yang ditetapkan dari tombol **Darurat**.



PEMBERITAHUAN:

Jika tekan singkat tombol **Darurat** menginisiasi mode Darurat, maka tekan lama ke tombol yang sama memungkinkan radio keluar dari mode Darurat.

Jika tekan lama tombol **Darurat** menginisiasi mode Darurat, maka tekan singkat ke tombol yang sama memungkinkan radio keluar dari mode Darurat.

Radio Anda mendukung tiga Alarm Darurat:

- Alarm Darurat
- Alarm Darurat dengan Panggilan
- Alarm Darurat dengan Suara untuk Diikuti 

**PEMBERITAHUAN:**

Hanya salah satu dari Alarm Darurat di atas dapat ditetapkan untuk tombol **Darurat** yang terprogram atau sakelar kaki Darurat.

Selain itu, tiap alarm mempunyai jenis berikut:

Reguler

Radio mentransmisikan sinyal alarm dan menunjukkan indikator audio dan/atau visual.

Senyap

Radio mentransmisikan sinyal alarm tanpa ada indikator audio atau visual. Radio menerima panggilan tanpa suara apa pun melalui speaker, sampai periode transmisi terprogram *hot mic* berakhir dan/atau Anda menekan tombol **PTT**.

Senyap dengan Suara

Radio mentransmisikan sinyal alarm tanpa indikator audio atau visual, tetapi memungkinkan panggilan masuk untuk berbunyi melalui speaker radio.





Menerima Alarm Darurat



Ikuti prosedur untuk menerima Alarm Darurat di radio Anda.

Ketika Anda menerima Alarm Darurat:

- Nada akan berbunyi.
- LED merah berkedip.
- Layar menampilkan ikon **Darurat**, dan alias pemanggil Darurat atau jika terdapat lebih dari satu alarm, semua alias pemanggil darurat ditampilkan di Daftar Alarm.

1 Lakukan salah satu langkah berikut:



- Jika hanya ada satu alarm, tekan  untuk melihat detail yang lebih lengkap.
- Jika ada lebih dari satu alarm, tekan  atau  ke alias yang diinginkan, lalu tekan  untuk melihat detail yang lebih lengkap.

2 Tekan  untuk melihat opsi tindakan.**3** Tekan  dan pilih  untuk keluar dari Daftar alarm.**4** Tekan  untuk mengakses menu.**5** Pilih **Daftar Alarm** untuk kembali ke daftar Alarm.

- 6 Nada berbunyi dan LED berkedip merah sampai Anda keluar dari mode Darurat. Namun, nada tersebut dapat dimatikan. Lakukan salah satu langkah berikut:
- Tekan tombol **PTT** untuk memanggil grup radio yang menerima Alarm Darurat.
 - Tekan sembarang tombol yang dapat diprogram.
 - Keluar dari mode Darurat. Lihat [Keluar dari Mode Darurat Setelah Menerima Alarm Darurat di halaman 441](#).
-

Merespons Alarm Darurat

Ikuti prosedur untuk merespons Panggilan Darurat di radio Anda.

- 1 Pastikan layar menampilkan Daftar Alarm. Tekan  atau  ke alias atau ID yang diinginkan.
- 2  Jika fitur Indikasi Saluran Bebas diaktifkan, nada peringatan singkat akan berbunyi saat pengguna radio yang melakukan transmisi melepaskan tombol **PTT**, yang menunjukkan saluran bebas dapat Anda gunakan untuk merespons. Tekan tombol **PTT** untuk

melakukan transmisi suara non-darurat ke grup yang sama dengan target Alarm Darurat.

LED hijau akan menyala. Radio akan tetap berada dalam mode Darurat.

- 3 Lakukan salah satu langkah berikut:
 - Tunggu hingga Nada Izin Bicara selesai dan bicaralah dengan jelas ke mikrofon, jika diaktifkan.
 -  Tunggu hingga Sidetone **PTT** selesai dan bicaralah dengan jelas ke mikrofon, jika diaktifkan.
 - 4 Lepaskan tombol **PTT** untuk mendengarkan. Ketika radio yang memulai darurat merespons:
 - LED akan berkedip hijau.
 - Layar menampilkan ikon dan ID **Panggilan Grup**, ID radio yang melakukan transmisi, dan daftar Alarm.
-

Suara darurat hanya dapat ditransmisikan melalui radio yang mengirim sinyal darurat. Semua radio lainnya,

termasuk radio yang menerima sinyal darurat, mentransmisikan suara non-darurat.

Keluar dari Mode Darurat Setelah Menerima Alarm Darurat

Lakukan salah satu dari berikut untuk keluar dari mode Darurat setelah menerima alarm Darurat:

- Hapus item alarm.
- Matikan radio.

Mengirim Alarm Darurat

Dengan fitur ini Anda bisa mengirim Alarm Darurat, sinyal non-suara, yang memicu indikasi peringatan pada sebuah grup radio. Radio Anda tidak menampilkan indikator audio maupun visual selama mode Darurat bila radio diatur ke Senyap.

Ikuti prosedur untuk mengirim Alarm Darurat di radio Anda.

- 1 Tekan tombol **Darurat Aktif** yang diprogram. Anda akan melihat satu dari hasil berikut ini:
 - Layar menampilkan Alarm Tx dan alias tujuan.

-  Layar menampilkan Telegram Tx dan alias tujuan.

LED hijau akan menyala. Ikon **Darurat** muncul.



PEMBERITAHUAN:

Jika diprogram, nada Pencarian Darurat akan berbunyi. Nada ini disenyapkan ketika radio memancarkan atau menerima suara, dan berhenti ketika radio keluar dari mode Darurat. Nada Pencarian Darurat dapat diprogram melalui CPS.

-
- 2 Tunggu respons.

Jika berhasil:

- Nada Darurat akan berbunyi.
- LED merah berkedip.
- Layar menampilkan Alarm Terkirim.

Jika tidak berhasil setelah batas mencoba tercapai:

- Nada akan berbunyi.
- Layar menampilkan Alarm Gagal.

Radio keluar dari mode Alarm Darurat dan kembali ke layar Awal.

Mengirim Alarm Darurat dengan Panggilan

Dengan fitur ini Anda bisa mengirim Alarm Darurat dengan Panggilan ke sekelompok radio. Setelah sebuah radio dalam grup itu memberi respons, grup radio tersebut bisa berkomunikasi melalui saluran Darurat terprogram. Ikuti prosedur untuk mengirim Alarm Darurat dengan panggilan di radio Anda.

- 1 Tekan tombol terprogram **Darurat Aktif** atau sakelar kaki **Darurat**. Layar menampilkan Mengirim Alarm, yang bergantian dengan ID radio Anda.

Anda akan melihat hal berikut:

- Layar menampilkan Telegram Tx dan alias tujuan.

LED hijau akan menyala. Ikon **Darurat** muncul.



PEMBERITAHUAN:

Jika diprogram, nada Pencarian Darurat akan berbunyi. Nada ini disenyapkan ketika radio memancarkan atau menerima suara, dan berhenti ketika radio keluar dari mode Darurat. Nada Pencarian Darurat dapat diprogram oleh dealer atau administrator sistem Anda.

- 2 Tunggu respons.

Jika berhasil:

- Nada Darurat akan berbunyi.
- LED merah berkedip.
- Layar menampilkan Alarm Terkirim.
- Radio masuk ke mode panggilan Darurat ketika layar menampilkan Darurat dan alias grup tujuan.

- 3 Tekan tombol **PTT** untuk melakukan panggilan.

LED hijau akan menyala. Layar menampilkan ikon **Panggilan Grup**.

- 4 Lakukan salah satu langkah berikut:
- Tunggu hingga Nada Izin Bicara selesai dan bicaralah dengan jelas ke mikrofon, jika diaktifkan.
 -  Tunggu hingga Sidetone **PTT** selesai dan bicaralah dengan jelas ke mikrofon, jika diaktifkan.

-
- 5 Lepaskan tombol **PTT** untuk mendengarkan. Layar menampilkan alias pemanggil dan grup.

-
- 6  Jika fitur Indikasi Saluran Bebas diaktifkan, nada peringatan singkat akan berbunyi saat pengguna radio yang melakukan transmisi melepaskan tombol **PTT**, yang menunjukkan saluran bebas dapat Anda gunakan untuk merespons. Tekan tombol **PTT** untuk menjawab panggilan.

-
- 7 Untuk keluar dari mode Darurat setelah panggilan berakhir, tekan tombol **Darurat Nonaktif**. Radio Anda kembali ke layar Awal.
-

Alarm Darurat dengan Suara untuk Diikuti

Dengan fitur ini Anda bisa mengirim Alarm Darurat dengan Suara untuk Diikuti ke sekelompok radio. Mikrofon radio diaktifkan secara otomatis, yang memungkinkan Anda berkomunikasi dengan grup radio tanpa menekan tombol **PTT**. Keadaan mikrofon yang diaktifkan ini disebut *hot mic*.



PEMBERITAHUAN:

Radio Anda tidak dapat mendeteksi mikrofon non-IMPRES yang terpasang ke konektor aksesori belakang.

Bila tidak ada mikrofon yang terdeteksi pada konektor terprogram yang ditentukan, radio memeriksa konektor alternatif. Di sini, radio memberikan prioritas pada mikrofon yang terdeteksi.

Jika radio Anda telah mengaktifkan Mode Siklus Darurat, pengulangan *hot mic* dan periode penerimaan dilakukan selama durasi yang sudah diprogram. Selama Mode Siklus Darurat, panggilan yang diterima terdengar melalui speaker.

Jika tombol **PTT** ditekan selama jangka waktu penerimaan yang telah diprogram, Anda akan mendengar nada dilarang bicara, yang menunjukkan bahwa Anda harus

melepas tombol **PTT**. Radio mengabaikan penekanan tombol **PTT** dan tetap dalam mode Darurat.

Jika Anda menekan tombol **PTT** selama *hot mic*, dan terus menekannya setelah durasi *hot mic* habis, radio terus mengirim transmisi sampai Anda melepaskan tombol **PTT**.

Jika permintaan Alarm Darurat gagal, radio tidak mencoba lagi mengirim permintaan, dan langsung masuk ke keadaan *hot mic*.



PEMBERITAHUAN:

Sebagian aksesori mungkin tidak mendukung *hot mic*. Tanyakan kepada penyalur atau administrator sistem Anda untuk informasi lebih lanjut.

Mengirim Alarm Darurat dengan Panduan Suara

Ikuti prosedur untuk mengirim Alarm Darurat dengan panduan suara di radio Anda.

- 1 Tekan tombol terprogram **Darurat Aktif** atau sakelar kaki **Darurat**.

Anda akan melihat satu dari hasil berikut ini:

- Layar menampilkan Alarm Tx dan alias tujuan.

- Layar menampilkan Telegram Tx dan alias tujuan.

LED hijau akan menyala. Ikon **Darurat** muncul.

-
- 2 Setelah layar menampilkan Alarm Terkirim, berbicaralah dengan jelas ke mikrofon.

Radio menghentikan transmisi secara otomatis apabila:

- Setelah durasi siklus antara *hot mic* dan menerima panggilan habis, jika Mode Siklus Darurat diaktifkan.
- Setelah durasi *hot mic* habis, jika Mode Siklus Darurat dinonaktifkan.

-
- 3 Tekan tombol **Darurat Nonaktif** untuk keluar dari mode Darurat.

Radio Anda kembali ke layar Awal.

Mengaktifkan Ulang Mode Darurat

Fitur ini hanya tersedia untuk radio yang mengirimkan Alarm Darurat. Ikuti prosedur untuk mengaktifkan ulang mode Darurat di radio Anda.

Lakukan salah satu langkah berikut:

- Ubah saluran ketika radio dalam mode Darurat. Radio keluar dari mode Darurat dan mengaktifkan ulang Darurat jika Alarm Darurat diaktifkan di saluran yang baru.
- Tekan tombol terprogram **Darurat Aktif** selama status pengaktifan/transmisi Darurat. Radio keluar dari status ini dan mengaktifkan kembali Darurat.

Keluar Mode Darurat Setelah Mengirim Alarm Darurat

Fitur ini hanya tersedia untuk radio yang mengirimkan Alarm Darurat.

Radio akan keluar dari Mode darurat saat:

- Menerima pemberitahuan (hanya untuk Alarm Darurat).
- Semua percobaan ulang untuk mengirim alarm habis.



PEMBERITAHUAN:

Jika radio dimatikan, radio keluar dari mode Darurat. Radio tidak akan menghidupkan ulang mode Darurat secara otomatis bila dihidupkan kembali.

Ikuti prosedur untuk keluar dari Mode darurat di radio.



Lakukan salah satu langkah berikut:



- Tekan tombol terprogram **Mati Darurat**.
- Ubah saluran ke saluran baru yang tidak memiliki konfigurasi sistem darurat. Layar menampilkan Tidak Ada Darurat.

Menghapus Item Alarm dari Daftar Alarm

Ikuti prosedur untuk menghapus item alarm dari Daftar Alarm, untuk keluar dari mode Darurat.

- 1 Tekan  untuk mengakses menu.

2 Tekan  atau  ke Daftar Alarm. Tekan  untuk memilih.

3 Tekan  atau  ke item alarm yang diinginkan. Tekan  untuk memilih.

4 Tekan  atau  ke Hapus. Tekan  untuk memilih.

Pengolahan Pesan Teks

Radio Anda mampu menerima data, misalnya pesan teks, dari radio lain atau aplikasi pesan teks.

Ada dua jenis pesan teks, Pesan Teks Singkat Radio Mobile Digital (DMR) dan pesan teks. Panjang maksimal Pesan Teks Singkat DMR adalah 23 karakter. Panjang maksimum pesan teks adalah 280 karakter, termasuk baris subjek. Baris subjek hanya muncul saat Anda menerima pesan dari aplikasi email.



PEMBERITAHUAN:

Panjang karakter maksimum hanya berlaku untuk model dengan perangkat lunak dan perangkat keras terbaru. Untuk model radio dengan perangkat lunak dan perangkat keras lama, panjang maksimum pesan teks adalah 140 karakter. Tanyakan kepada penyalur atau administrator sistem Anda untuk informasi lebih lanjut.

Pesan Teks



Pesan teks disimpan di Kotak Masuk, dan diurutkan sesuai pesan yang paling baru.

Melihat Pesan Teks

Ikuti prosedur untuk melihat pesan teks di radio Anda.



1 Tekan  untuk mengakses menu.

2 Tekan  atau  ke Pesan. Tekan  untuk memilih.



3 Tekan  atau  ke Kotak Masuk. Tekan  untuk memilih.



Jika Kotak Masuk kosong:

- Layar menampilkan Daftar Kosong.
- Nada akan berbunyi jika Nada Keypad diaktifkan.

4 Tekan  atau  ke pesan yang diinginkan. Tekan  untuk memilih.

Layar menampilkan baris subjek jika pesan berasal dari aplikasi e-mail.

3 Tekan  atau  ke Kotak Masuk. Tekan  untuk memilih.

4 Tekan  atau  ke pesan yang diperlukan. Tekan  untuk memilih.

Anda tidak dapat membalas pesan teks Status Telemetri.

Layar akan menampilkan Telemetri: <Pesan Teks Status>.

5 Tekan lama  untuk kembali ke layar Awal.

Melihat Pesan Teks Status Telemetri

Ikuti prosedur untuk melihat pesan teks status telemetri dari Kotak Masuk.

1 Tekan  untuk mengakses menu.

2 Tekan  atau  ke Pesan. Tekan  untuk memilih.

Merespons Pesan Teks

Ikuti prosedur untuk merespons pesan teks di radio Anda.









Ketika Anda menerima pesan teks:

- Layar menampilkan daftar Notifikasi disertai alias atau ID pengirim.
- Layar menampilkan ikon **Pesan**.

**PEMBERITAHUAN:**

Radio keluar dari layar peringatan pesan teks dan menyiapkan Panggilan Pribadi atau Grup ke pengirim pesan jika tombol **PTT** ditekan.

1 Lakukan salah satu langkah berikut:

- Tekan  atau  ke **Baca**. Tekan  untuk memilih.
Layar menampilkan pesan teks. Layar menampilkan baris subjek jika pesan berasal dari aplikasi e-mail.
- Tekan  atau  ke **Baca Nanti**. Tekan  untuk memilih.
Radio kembali ke layar yang dibuka sebelum Anda menerima pesan teks.
- Tekan  atau  ke **Hapus**. Tekan  untuk memilih.

2 Lakukan salah satu langkah berikut:

- Tekan  untuk kembali ke Kotak Masuk.

- Tekan  sekali lagi untuk membalas, meneruskan, atau menghapus pesan teks.



Merespons Pesan Teks dengan Balasan 

Ikuti prosedur untuk merespons pesan teks dengan pesan Teks Cepat di radio Anda.

1 Lakukan salah satu langkah berikut:

- Tekan tombol **Pesan Teks** terprogram. Lanjutkan ke Langkah [langkah 3](#).
- Tekan  untuk mengakses menu.

2

Tekan  atau  ke **Pesan**. Tekan  untuk memilih.

3

Tekan  atau  ke **Kotak Masuk**. Tekan  untuk memilih.

4 Tekan  atau  ke pesan yang diinginkan.

Tekan  untuk memilih.

Layar menampilkan baris subjek jika pesan berasal dari aplikasi e-mail.

5 Tekan  untuk mengakses sub-menu.

6 Tekan  atau  ke **Balas**. Tekan  untuk memilih.

7 Tekan  atau  ke **Balas Cepat**. Tekan  untuk memilih.

8 Tekan  atau  ke pesan yang diinginkan.

Tekan  untuk memilih.

Layar menampilkan pemberitahuan mini transisional, yang mengonfirmasi bahwa pesan sedang dikirim.

9 Tunggu respons.

Jika berhasil:

- Nada akan berbunyi.
- Layar menampilkan pemberitahuan mini positif.

Jika tidak berhasil:

- Nada akan berbunyi.
 - Layar menampilkan pemberitahuan mini negatif.
 - Radio kembali ke layar opsi Kirim Ulang.
-

Mengirim Ulang Pesan Teks

Ikuti prosedur untuk mengirim ulang pesan teks di radio Anda.

Ketika berada di layar opsi Kirim Ulang:

Tekan  untuk mengirim ulang pesan yang sama ke alias atau ID subscriber atau grup yang sama.

Jika berhasil:

- Nada indikator positif akan berbunyi.
- Layar menampilkan pemberitahuan mini positif.



Jika tidak berhasil:



- Nada indikator negatif akan berbunyi.
- Layar menampilkan pemberitahuan mini negatif.
- Radio kembali ke layar opsi Kirim Ulang.

Meneruskan Pesan Teks

Ikuti prosedur untuk meneruskan pesan teks di radio Anda.

Ketika berada di layar opsi Kirim Ulang:

- 1 Tekan  atau  ke Teruskan, dan tekan  untuk mengirim pesan yang sama ke alias atau ID subscriber atau grup.

- 2 Tekan  atau  ke alias atau ID yang diinginkan. Tekan  untuk memilih. Layar menampilkan pemberitahuan mini transisional, yang mengonfirmasi bahwa pesan sedang dikirim.

- 3 Tunggu respons.

Jika berhasil:

- Nada indikator positif akan berbunyi.
- Layar menampilkan pemberitahuan mini positif.

Jika tidak berhasil:

- Nada indikator negatif akan berbunyi.
- Layar menampilkan pemberitahuan mini negatif.



PEMBERITAHUAN:

Anda juga dapat memilih alamat radio target secara manual (lihat [Meneruskan Pesan Teks Menggunakan Panggilan Manual di halaman 450](#)).

Meneruskan Pesan Teks Menggunakan Panggilan Manual

Ikuti prosedur untuk meneruskan pesan teks menggunakan panggilan manual di radio Anda.

- 1 Tekan  atau  ke Teruskan. Tekan  untuk memilih.

2 Tekan  untuk mengirim pesan yang sama ke alias atau ID grup atau subscriber lain.

3 Tekan  atau  ke Panggilan Manual.

Tekan  untuk memilih.

Layar menampilkan Nomor Radio:.

4 Masukkan ID subscriber, lalu tekan  untuk melanjutkan.

Layar menampilkan pemberitahuan mini transisional, yang mengonfirmasi bahwa pesan sedang dikirim.

5 Tunggu respons.

Jika berhasil:

- Nada akan berbunyi.
- Layar menampilkan pemberitahuan mini positif.

Jika tidak berhasil:

- Nada akan berbunyi.

- Layar menampilkan pemberitahuan mini negatif.

Mengedit Pesan Teks

Pilih **Edit** untuk mengedit pesan.







PEMBERITAHUAN:

Jika terdapat baris subjek (untuk pesan yang diterima dari aplikasi email), Anda tidak dapat mengeditnya.

1 Tekan  atau  ke **Edit**. Tekan  untuk memilih.

Layar menampilkan kursor berkedip.

2 Gunakan keypad untuk mengedit pesan.

- Tekan  untuk bergerak satu spasi ke kiri.
- Tekan  atau  untuk bergerak satu spasi ke kanan.
- Tekan  untuk menghapus karakter yang tidak diinginkan.

- Tekan lama untuk mengganti metode entri teks.

3 Tekan setelah selesai membuat pesan.

4 Lakukan salah satu langkah berikut:

- Tekan atau ke Kirim dan tekan untuk mengirim pesan.
- Tekan atau ke Simpan dan tekan untuk menyimpan pesan ke folder Konsep.
- Tekan untuk mengedit pesan.
- Tekan untuk memilih antara menghapus pesan atau menyimpannya di folder Konsep.

Menulis Pesan Teks

Ikuti prosedur untuk menulis pesan teks di radio Anda.

1 Lakukan salah satu langkah berikut:

- Tekan tombol **Pesan Teks** terprogram. Lanjutkan ke [langkah 3](#).

- Tekan untuk mengakses menu.

2 Tekan atau ke Pesan. Tekan untuk memilih.

3 Tekan atau ke Tulis. Tekan untuk memilih.
Kursor berkedip akan ditampilkan.







4 Gunakan keypad untuk mengetik pesan.

Tekan untuk bergerak satu spasi ke kiri.

Tekan atau untuk bergerak satu spasi ke kanan.

Tekan untuk menghapus karakter yang tidak diinginkan.

Tekan lama untuk mengganti metode entri teks.

- 5 Tekan  setelah selesai membuat pesan. Lakukan salah satu langkah berikut:
- Tekan  untuk mengirim pesan.
 - Tekan . Tekan  atau  untuk memilih antara mengedit, menghapus, atau menyimpan pesan. Tekan  untuk memilih.

Mengirim Pesan Teks

Ikuti prosedur untuk mengirim pesan teks di radio Anda.

Dalam prosedur ini Anda dianggap memiliki pesan teks yang baru ditulis atau pesan teks tersimpan.

Pilih penerima pesan. Lakukan salah satu langkah berikut:

- Tekan  atau  ke alias atau ID yang diperlukan. Tekan  untuk memilih.

- Tekan  atau  ke Panggilan Manual.

Tekan  untuk memilih. Masukkan ID subscriber. Baris pertama layar menampilkan Radio Number: (Nomor Radio:). Baris kedua layar menampilkan kursor yang berkedip.

Masukkan alias atau ID subscriber. Tekan .

Layar akan menampilkan pemberitahuan mini sementara, yang mengonfirmasi bahwa pesan Anda sedang dikirim.

Jika berhasil:

- Nada akan berbunyi.
- Layar menampilkan pemberitahuan mini positif.

Jika tidak berhasil:

- Nada rendah akan terdengar.
- Layar menampilkan pemberitahuan mini negatif.
- Pesan dipindah ke folder Item Terkirim.
- Pesan ditandai dengan ikon Gagal Terkirim.









PEMBERITAHUAN:











Untuk pesan teks yang baru ditulis, radio kembali ke layar opsi Kirim Ulang.

Menghapus Pesan Teks dari Kotak Masuk

Ikuti prosedur untuk menghapus pesan teks dari Kotak Masuk di radio Anda.

- 1 Lakukan salah satu langkah berikut:
 - Tekan tombol **Pesan Teks** terprogram. Lanjutkan ke [langkah 3](#).
 - Tekan  untuk mengakses menu.
- 2 Tekan  atau  ke Pesan. Tekan  untuk memilih.
- 3 Tekan  atau  ke Kotak Masuk. Tekan  untuk memilih.
Jika Kotak Masuk kosong:
 - Layar menampilkan Daftar Kosong.

- Nada akan berbunyi.



- 4 Tekan  atau  ke pesan yang diperlukan. Tekan  untuk memilih.
Layar menampilkan baris subjek jika pesan berasal dari aplikasi e-mail.
- 5 Tekan  untuk mengakses sub-menu.
- 6 Tekan  atau  ke Hapus. Tekan  untuk memilih.
- 7 Tekan  atau  ke Ya. Tekan  untuk memilih.
Layar menampilkan pemberitahuan mini positif.
Layar kembali ke Kotak Masuk.

Menghapus Semua Pesan Teks dari Kotak Masuk

Ikuti prosedur untuk menghapus semua pesan teks dari Kotak Masuk di radio Anda.



- 1 Lakukan salah satu langkah berikut:
 - Tekan tombol **Pesan Teks** terprogram. Lanjutkan ke [langkah 3](#).
 - Tekan  untuk mengakses menu.

- 2 Tekan  atau  ke **Pesan**. Tekan  untuk memilih.

- 3 Tekan  atau  ke **Kotak Masuk**. Tekan  untuk memilih.

Jika Kotak Masuk kosong:

- Layar menampilkan **Daftar Kosong**.
- Nada akan berbunyi.

- 4 Tekan  atau  ke **Hapus Semua**. Tekan  untuk memilih.

- 5 Tekan  atau  ke **Ya**. Tekan  untuk memilih.

Layar menampilkan pemberitahuan mini positif.

Pesan Teks Terkirim

Setelah terkirim ke radio lain, pesan akan disimpan di folder Item Terkirim. Pesan teks terkirim terbaru selalu ditambahkan ke bagian teratas di folder Item Terkirim. Anda dapat mengirim ulang, meneruskan, mengedit, atau menghapus pesan teks Terkirim.

Folder Item Terkirim mampu menyimpan maksimal 30 pesan terakhir yang terkirim. Ketika folder penuh, pesan teks terkirim berikutnya akan otomatis menggantikan pesan teks terlama di folder itu.

Jika Anda keluar dari layar pengiriman pesan teks ketika pesan sedang dikirimkan, radio memperbarui status pesan dalam folder Item Terkirim tanpa memberikan indikasi apa pun di layar atau melalui suara.

Jika radio berganti mode atau mati sebelum status pesan di Item Terkirim diperbarui, radio tidak akan dapat menyelesaikan pesan Dalam Proses apa pun dan otomatis menandainya dengan ikon **Gagal Terkirim**.

Radio mendukung maksimal lima pesan Sedang Berlangsung dalam satu waktu. Selama periode ini, radio tidak dapat mengirimkan pesan baru apa pun dan otomatis menandainya dengan ikon **Gagal Terkirim**.

Jika tombol  ditekan lama kapan saja, radio kembali ke layar Awal.



PEMBERITAHUAN:



Jika jenis saluran, misalnya saluran digital konvensional atau Capacity Plus, tidak cocok, Anda hanya dapat mengedit, meneruskan, atau menghapus Pesan terkirim.

Melihat Pesan Teks Terkirim

Ikuti prosedur untuk melihat pesan teks terkirim di radio Anda.



- 1 Lakukan salah satu langkah berikut:
 - Tekan tombol **Pesan Teks** terprogram. Lanjutkan ke [langkah 3](#).
 - Tekan  untuk mengakses menu.

- 2 Tekan  atau  ke **Pesan**. Tekan  untuk memilih.

- 3 Tekan  atau  ke **Item Terkirim**. Tekan  untuk memilih.

Jika folder Item Terkirim kosong:

- Layar menampilkan **Daftar Kosong**.
- Nada rendah akan berbunyi jika Nada Keypad diaktifkan.





- 4 Tekan  atau  ke pesan yang diinginkan. Tekan  untuk memilih.

Ikon di sudut kanan atas layar menunjukkan status pesan. Lihat [Ikon Item Terkirim](#).

Mengirim Pesan Teks Terkirim

Ikuti prosedur untuk mengirim sebuah pesan teks terkirim di radio Anda.

Ketika Anda melihat pesan Terkirim:

- 1 Tekan  saat melihat pesan.
-
- 2 Anda dapat mengirim ulang atau meneruskan pesan teks terkirim. Lakukan salah satu langkah berikut:
 -  ke Kirim Ulang. Tekan  untuk memilih.
 -  ke Teruskan. Tekan  untuk memilih.

Layar menampilkan pemberitahuan mini transisional, yang mengonfirmasi bahwa pesan sedang dikirim.

- 3 Tunggu respons.

Jika berhasil:

- Nada indikator positif akan berbunyi.
- Layar menampilkan pemberitahuan mini positif.

Jika tidak berhasil:





- Nada indikator negatif akan berbunyi.
- Layar menampilkan pemberitahuan mini negatif.

- Radio masuk ke layar opsi Kirim Ulang. Lihat [Mengirim Ulang Pesan Teks di halaman 157](#) untuk informasi selengkapnya.

Menghapus Pesan Teks Terkirim dari folder Item Terkirim

Ikuti prosedur untuk menghapus pesan teks terkirim dari folder Item Terkirim di radio Anda.

Ketika Anda melihat pesan Terkirim:

- 1 Tekan  .
-
- 2 Tekan  atau  ke Hapus. Tekan  untuk memilih.



Menghapus Semua Pesan Teks Terkirim dari folder Item Terkirim

Ikuti prosedur untuk menghapus semua pesan teks terkirim dari folder Item Terkirim di radio Anda.

- 1 Lakukan salah satu langkah berikut:

- Tekan tombol **Pesan Teks** terprogram. Lanjutkan ke [langkah 3](#).
- Tekan  untuk mengakses menu.

2 Tekan  atau  ke **Pesan**. Tekan  untuk memilih.

3 Tekan  atau  ke **Item Terkirim**. Tekan  untuk memilih.

Jika folder **Item Terkirim** kosong:

- Layar menampilkan **Daftar Kosong**.
- Nada akan berbunyi.

4 Tekan  atau  ke **Hapus Semua**. Tekan  untuk memilih.

5 Lakukan salah satu langkah berikut:

- Tekan  atau  ke **Ya**. Tekan  untuk memilih. Layar menampilkan pemberitahuan mini positif.

- Tekan  atau  ke **Tidak**. Tekan  untuk memilih. Radio kembali ke layar sebelumnya.

Pesan SMS Tersimpan

Anda dapat menyimpan pesan SMS untuk mengirimkannya nanti.

Jika penekanan tombol **PTT** atau perubahan mode mengakibatkan radio keluar dari layar penulisan/ pengeditan sewaktu Anda menulis atau mengedit pesan teks, maka pesan teks tersebut akan secara otomatis disimpan ke folder **Konsep**.



Pesan SMS yang paling baru disimpan selalu ditambahkan di bagian atas daftar **Draf**.



Folder **Draf** menyimpan maksimum 10 pesan terakhir yang disimpan. Saat folder penuh, pesan SMS yang berikutnya disimpan akan otomatis menggantikan pesan SMS terlama dalam folder.



Melihat Pesan Teks Tersimpan

Ikuti prosedur untuk melihat pesan teks tersimpan di radio Anda.

- 1 Lakukan salah satu langkah berikut:
 - Tekan tombol **Pesan Teks** terprogram. Lanjutkan ke [langkah 3](#).
 - Tekan  untuk mengakses menu.

- 2 Tekan  atau  ke **Pesan**. Tekan  untuk memilih.



- 3 Tekan  atau  ke **Konsep**. Tekan  untuk memilih.

- 4 Tekan  atau  ke pesan yang diperlukan. Tekan  untuk memilih.

Mengedit Pesan Teks Tersimpan



Ikuti prosedur untuk mengedit pesan teks tersimpan di radio Anda.

- 1 Tekan  saat melihat pesan.

- 2 Tekan  atau  ke **Edit**. Tekan  untuk memilih. Kursor berkedip akan ditampilkan.

- 3 Gunakan keypad untuk mengetik pesan.

Tekan  untuk bergerak satu spasi ke kiri.

Tekan  atau  untuk bergerak satu spasi ke kanan.

Tekan  untuk menghapus karakter yang tidak diinginkan.

Tekan lama  untuk mengganti metode entri teks.

- 4 Tekan  setelah selesai membuat pesan. Lakukan salah satu langkah berikut:

- Tekan  atau  ke **Kirim**. Tekan  untuk mengirim pesan.

- Tekan . Tekan  atau  untuk memilih antara menyimpan atau menghapus pesan. Tekan  untuk memilih.
-



Menghapus Pesan Teks Tersimpan dari Folder Konsep



Ikuti prosedur untuk menghapus pesan teks tersimpan dari konsep di radio Anda.

- 1 Lakukan salah satu langkah berikut:
 - Tekan tombol **Pesan Teks** terprogram. Lanjutkan ke [langkah 3](#).
 - Tekan  untuk mengakses menu.
-

- 2 Tekan  atau  ke **Pesan**. Tekan  untuk memilih.
-

- 3 Tekan  atau  ke **Konsep**. Tekan  untuk memilih.
-

- 4 Tekan  atau  ke pesan yang diperlukan. Tekan  untuk memilih.
-

- 5 Tekan  atau  ke **Hapus**. Tekan  untuk menghapus pesan teks.
-

Pesan Teks Cepat

Radio Anda mendukung maksimum 50 pesan Teks Cepat yang telah diprogram oleh dealer.

Meskipun isi pesan Teks Cepat telah ditentukan sebelumnya, Anda dapat mengedit setiap pesan sebelum mengirimnya.

Mengirim Pesan Teks Cepat

Ikuti prosedur untuk mengirim pesan Teks Cepat yang sudah ditentukan sebelumnya di radio Anda ke alias yang sudah ditentukan sebelumnya.

- 1 Lakukan salah satu langkah berikut:
 - Tekan tombol **Pesan Teks** terprogram. Lanjutkan ke [langkah 6](#).



- Tekan tombol **Akses Satu Sentuhan** terprogram. Layar menampilkan pemberitahuan mini transisional, yang mengonfirmasi bahwa pesan sedang dikirim.

Lanjutkan ke [langkah 6](#).

- Tekan  untuk mengakses menu.

-
- 2** Tekan  atau  ke **Pesan**. Tekan  untuk memilih.

-
- 3** Tekan  atau  ke **Teks Cepat**. Tekan  untuk memilih.

-
- 4** Tekan  atau  ke pesan **Teks Cepat** yang diperlukan. Tekan  untuk memilih.

-
- 5** Lakukan hal berikut untuk memilih penerima dan mengirim pesan.

Layar menampilkan pemberitahuan mini transisional, yang mengonfirmasi bahwa pesan sedang dikirim.

- 6** Tunggu respons.

Jika berhasil:

- Nada indikator positif akan berbunyi.
- Layar menampilkan pemberitahuan mini positif.

Jika tidak berhasil:

- Nada indikator negatif akan berbunyi.
- Layar menampilkan pemberitahuan mini negatif.
- Radio masuk ke layar opsi **Kirim Ulang**. Lihat [Mengirim Ulang Pesan Teks di halaman 157](#) untuk informasi selengkapnya.

Konfigurasi Entri Teks

Radio ini memungkinkan Anda mengonfigurasi teks yang berbeda.

Anda dapat mengonfigurasi pengaturan berikut untuk memasukkan teks di radio Anda:

- Prediksi Kata
- Koreksi Kata
- Kapitalisasi Kalimat

- Kata Saya

Radio Anda mendukung metode entri teks berikut:

- Angka
- Simbol
- Prediktif atau Multisentuh
- Bahasa (Jika diprogram)



PEMBERITAHUAN:

Tekan  kapan saja untuk kembali ke layar

sebelumnya atau tekan lama  untuk kembali ke Layar Awal. Radio keluar dari layar saat ini setelah pencatat waktu nonaktif berakhir.

Mengaktifkan atau Menonaktifkan Koreksi Kata



Menyediakan pilihan kata alternatif saat kata yang dimasukkan ke dalam editor teks tidak dikenali oleh kamus yang ada di dalamnya.

- 1 Tekan  untuk mengakses menu.
-







- 2 Tekan  atau  ke *Utilitas*. Tekan  untuk memilih.
-

- 3 Tekan  atau  ke *Pengaturan Radio*. Tekan  untuk memilih.
-

- 4 Tekan  atau  ke *Entri Teks*. Tekan  untuk memilih.
-

- 5 Tekan  atau  ke *Koreksi Kata*. Tekan  untuk memilih.
-

- 6 Lakukan salah satu langkah berikut:

- Tekan  atau  ke *Koreksi Kata*. Tekan  untuk memilih.
 - Tekan  untuk mengaktifkan *Koreksi Kata*. Jika diaktifkan,  muncul di sebelah *Diaktifkan*.
 - Tekan  untuk menonaktifkan *Koreksi Kata*. Jika dinonaktifkan,  hilang dari sebelah *Diaktifkan*.
-

Mengaktifkan atau Menonaktifkan Prediksi Kata

Prediksi Kata: Radio Anda bisa mempelajari urutan kata umum yang sering Anda masukkan. Kemudian memprediksi kata berikutnya yang mungkin ingin Anda gunakan setelah memasukkan kata pertama dari urutan kata umum ke dalam editor teks.

- 1 Tekan  untuk mengakses menu.



- 2 Tekan  atau  ke Utilitas. Tekan  untuk memilih.

- 3 Tekan  atau  ke Pengaturan Radio. Tekan  untuk memilih.

- 4 Tekan  atau  ke Entri Teks. Tekan  untuk memilih.

- 5 Tekan  atau  ke Prediksi Kata. Tekan  untuk memilih.



6 Lakukan salah satu langkah berikut:



- Tekan  untuk mengaktifkan Prediksi Kata. Jika diaktifkan, ✓ muncul di sebelah Diaktifkan.
- Tekan  untuk menonaktifkan Kontrol Distorsi Dinamis Mikrofon. Jika dinonaktifkan, ✓ hilang dari sebelah Diaktifkan.

Kapitalisasi Kalimat



Fitur ini digunakan untuk mengaktifkan kapitalisasi secara otomatis untuk huruf awal kata pertama pada setiap kalimat baru.

- 1 Tekan  untuk mengakses menu.



- 2 Tekan  atau  ke Utilitas. Tekan  untuk memilih.

- 3 Tekan  atau  ke Pengaturan Radio. Tekan  untuk memilih.

4 Tekan  atau  ke Entri Teks. Tekan  untuk memilih.

5 Tekan  atau  ke Kapitalisasi Kalimat. Tekan  untuk memilih.

6 Lakukan salah satu langkah berikut:

- Tekan  untuk mengaktifkan Kapitalisasi Kalimat. Jika diaktifkan, ✓ muncul di sebelah Diaktifkan.
 - Tekan  untuk menonaktifkan Kapitalisasi Kalimat. Jika dinonaktifkan, ✓ hilang dari sebelah Diaktifkan.
-

Melihat Kata Khusus



Anda dapat menambahkan kata khusus sendiri ke kamus internal di radio. Radio Anda menyimpan daftar yang berisi kata ini.



1 Tekan  untuk mengakses menu.

2 Tekan  atau  ke Utilitas. Tekan  untuk memilih.

3 Tekan  atau  ke Pengaturan Radio. Tekan  untuk memilih.

4 Tekan  atau  ke Entri Teks. Tekan  untuk memilih.

5 Tekan  atau  ke Kata-Kata Saya. Tekan  untuk memilih.

6 Tekan  atau  ke Daftar Kata. Tekan  untuk memilih.

Layar akan menampilkan daftar kata khusus tersebut.

Mengedit Kata Khusus

Anda bisa mengedit kata khusus yang disimpan di radio Anda.



1 Tekan  untuk mengakses menu.

2 Tekan  atau  ke Utilitas. Tekan  untuk memilih.

3 Tekan  atau  ke Pengaturan Radio. Tekan  untuk memilih.

4 Tekan  atau  ke Entri Teks. Tekan  untuk memilih.

5 Tekan  atau  ke Kata-Kata Saya. Tekan  untuk memilih.



6 Tekan  atau  ke Daftar Kata. Tekan  untuk memilih.

Layar akan menampilkan daftar kata khusus tersebut.

7 Tekan  atau  ke kata yang diinginkan. Tekan  untuk memilih.

8 Tekan  atau  ke Edit. Tekan  untuk memilih.

9 Gunakan keypad untuk mengedit kata khusus Anda.

- Tekan  untuk bergerak satu spasi ke kiri.
- Tekan tombol  untuk bergerak satu spasi ke kanan.
- Tekan  untuk menghapus karakter yang tidak diinginkan.

- Tekan lama  untuk mengganti metode entri teks.

10 Tekan  setelah kata khusus Anda selesai.

Layar menampilkan pemberitahuan mini transisional, yang mengonfirmasikan bahwa pembaruan status Anda sedang disimpan.

- Jika kata khusus disimpan, sebuah nada akan berbunyi dan layar menampilkan pemberitahuan mini positif.
- Jika kata khusus tidak disimpan, sebuah nada rendah akan berbunyi dan layar menampilkan pemberitahuan mini negatif.

Menambahkan Kata Khusus

Anda dapat menambahkan kata khusus ke kamus internal radio.

1 Tekan  untuk mengakses menu.

2 Tekan  atau  ke **Utilitas**. Tekan  untuk memilih.

3 Tekan  atau  ke **Pengaturan Radio**.

Tekan  untuk memilih.



4 Tekan  atau  ke **Entri Teks**. Tekan  untuk memilih.



5 Tekan  atau  ke **Kata-Kata Saya**. Tekan  untuk memilih.

6 Tekan  atau  ke **Tambah Kata Baru**. Tekan  untuk memilih.

Layar akan menampilkan daftar kata khusus tersebut.

7 Gunakan keypad untuk mengedit kata khusus Anda.

- Tekan  untuk bergerak satu spasi ke kiri.
- Tekan tombol  untuk bergerak satu spasi ke kanan.

- Tekan  untuk menghapus karakter yang tidak diinginkan.
- Tekan lama  untuk mengganti metode entri teks.

8 Tekan  setelah kata khusus Anda selesai.

Layar menampilkan pemberitahuan mini transisional, yang mengonfirmasi bahwa pembaruan status Anda sedang disimpan.



- Jika kata khusus disimpan, sebuah nada akan berbunyi dan layar menampilkan pemberitahuan mini positif.
- Jika kata khusus tidak disimpan, sebuah nada rendah akan berbunyi dan layar menampilkan pemberitahuan mini negatif.

Menghapus Kata Khusus



Ikuti prosedur untuk menghapus kata khusus yang disimpan di radio Anda.

1 Tekan  untuk mengakses menu.

2 Tekan  atau  ke *Utilitas*. Tekan  untuk memilih.

3 Tekan  atau  ke *Pengaturan Radio*. Tekan  untuk memilih.





4 Tekan  atau  ke *Entri Teks*. Tekan  untuk memilih.

5 Tekan  atau  ke *Kata-Kata Saya*. Tekan  untuk memilih.

6 Tekan  atau  ke kata yang diinginkan. Tekan  untuk memilih.

7 Tekan  atau  ke *Hapus*. Tekan  untuk memilih.



8 Lakukan salah satu hal berikut.



- Pada Hapus Entri?, tekan  untuk memilih Ya. Layar menampilkan Entri Dihapus.
 - Tekan  atau  ke Tidak. Tekan  untuk kembali ke layar sebelumnya.
-



Menghapus Semua Kata Khusus



Ikuti prosedur untuk menghapus semua kata khusus dari kamus internal di radio Anda.



- 1 Tekan  untuk mengakses menu.

 - 2 Tekan  atau  ke Utilitas. Tekan  untuk memilih.





 - 3 Tekan  atau  ke Pengaturan Radio. Tekan  untuk memilih.

 - 4 Tekan  atau  ke Entri Teks. Tekan  untuk memilih.
-

- 5 Tekan  atau  ke Kata-Kata Saya. Tekan  untuk memilih.
-

- 6 Tekan  atau  ke Hapus Semua. Tekan  untuk memilih.
-

- 7 Lakukan salah satu langkah berikut:

- Pada Hapus Entri?, tekan  untuk memilih Ya. Layar menampilkan Semua Entri Dihapus.
 - Tekan  atau  ke Tidak untuk kembali ke layar sebelumnya. Tekan  untuk memilih.
-

Tiket Tugas

Fitur ini memungkinkan radio Anda menerima pesan dari dispatcher berisi daftar tugas yang harus dijalankan.

**PEMBERITAHUAN:**

Fitur ini dapat disesuaikan melalui CPS sesuai dengan persyaratan pengguna. Tanyakan kepada penyalur atau administrator sistem Anda untuk informasi lebih lanjut.

Ada dua folder yang berisi Tiket Tugas yang berbeda:

Folder Tugas Saya

Tiket Tugas yang dapat dipersonalisasi ditugaskan ke ID pengguna yang Anda masuki.

Folder Tugas yang Dibagikan

Tiket Tugas yang dibagikan ditetapkan ke grup atau individu.

Anda dapat merespons Tiket Tugas untuk menyortirnya ke dalam Folder Tiket Tugas. Secara default, foldernya adalah **Semua**, **Baru**, **Dimulai**, dan **Selesai**. Untuk 10 folder tambahan, hubungi dealer atau administrator sistem Anda.

**PEMBERITAHUAN:**

Tiket Tugas akan disimpan meskipun radio dimatikan dan dihidupkan kembali.

Semua Tiket Tugas berada di folder **Semua**. Tergantung bagaimana radio Anda diprogram, Tiket Tugas disortir berdasarkan tingkat prioritas yang diikuti dengan waktu penerimaan. Tiket Tugas Baru, yaitu Tiket Tugas dengan status perubahan terbaru, dan Tiket Tugas dengan prioritas

tertinggi dicantumkan terlebih dulu. Setelah mencapai jumlah maksimum, Tiket Tugas berikutnya akan secara otomatis menggantikan Tiket Tugas terakhir yang ada di radio. Radio Anda mendukung maksimum 100 atau 500 Tiket Tugas, tergantung pada model radio. Tanyakan kepada penyalur atau administrator sistem Anda untuk informasi lebih lanjut. Radio Anda secara otomatis mendeteksi dan membuang Tiket Tugas duplikat dengan ID Tiket Tugas yang sama.

Tergantung pada pentingnya Tiket Tugas, dispatcher menambahkan Tingkat Prioritas ke dalamnya. Ada tiga tingkat prioritas: Prioritas 1, Prioritas 2, dan Prioritas 3. Prioritas 1 memiliki prioritas tertinggi dan Prioritas 3 adalah yang terendah. Selain itu ada Tiket Tugas tanpa prioritas.



Radio Anda memperbarui saat dispatcher melakukan perubahan berikut ini:



- Memodifikasi konten Tiket Tugas.
- Menambahkan atau mengedit Tingkat Prioritas Tiket Tugas.
- Memindahkan Tiket Tugas dari folder ke folder.
- Membatalkan Tiket Tugas.



Mengakses Folder Tiket Tugas

Ikuti prosedur untuk mengakses folder Tiket Tugas.

- 1 Lakukan salah satu langkah berikut:
 - Tekan tombol **Tiket Tugas** terprogram. Lanjutkan ke [langkah 3](#).
 - Tekan  untuk mengakses menu.

- 2 Tekan  atau  ke Tiket Tugas. Tekan  untuk memilih.



- 3 Tekan  atau  ke folder yang diinginkan. Tekan  untuk memilih.

- 4 Tekan  atau  ke Tiket Tugas yang diinginkan. Tekan  untuk memilih.

Masuk atau Keluar dari Server Jauh

Fitur ini memungkinkan Anda masuk dan keluar dari server jauh menggunakan ID pengguna.

- 1 Tekan  untuk mengakses menu.

- 2 Tekan  atau  ke Masuk. Tekan  untuk memilih.
 Jika Anda sudah masuk, menu menampilkan Keluar.
 Layar menampilkan pemberitahuan mini transisional, yang menunjukkan permintaan sedang diproses.







- 3 Tunggu respons.
 Jika berhasil:
 - Nada indikator positif akan berbunyi.
 - Layar menampilkan pemberitahuan mini positif.
 Jika tidak berhasil:
 - Nada indikator negatif akan berbunyi.

- Layar menampilkan pemberitahuan mini negatif.

Membuat Tiket Tugas















Radio mempunyai kemampuan untuk membuat Tiket Tugas berdasarkan template Tiket Tugas dan mengirim tugas yang harus dilakukan.

Perangkat lunak pemrograman CPS diperlukan untuk mengonfigurasi template Tiket Tugas.

- 1 Tekan  untuk mengakses menu.
- 2 Tekan  atau  ke Tiket Tugas. Tekan  untuk memilih.
- 3 Tekan  atau  ke Buat Tiket. Tekan  untuk memilih.

Merespons Tiket Tugas

Ikuti prosedur untuk merespons tiket tugas di radio Anda.

- 1 Tekan  untuk mengakses menu.
- 2 Tekan  atau  ke Tiket Tugas. Tekan  untuk memilih.
- 3 Tekan  atau  ke folder yang diinginkan. Tekan  untuk memilih.
- 4 Tekan  atau  ke tiket tugas yang diinginkan. Tekan  untuk memilih.
- 5 Tekan  sekali lagi untuk mengakses submenu. Anda dapat juga menekan tombol angka yang terkait (1-9) untuk **Balas Cepat**.
- 6 Tekan  atau  ke tiket tugas yang diinginkan. Tekan  untuk memilih. Layar menampilkan pemberitahuan mini transisional, yang menunjukkan permintaan sedang diproses.

7 Tunggu respons.

Jika berhasil:

- Nada indikator positif akan berbunyi.
- Layar menampilkan pemberitahuan mini positif.



Jika tidak berhasil:

- Nada indikator negatif akan berbunyi.
- Layar menampilkan pemberitahuan mini negatif.

Mengirim Tiket Tugas Menggunakan Satu Template Tiket Tugas

Jika radio Anda dikonfigurasi dengan satu template Tiket Tugas, lakukan tindakan berikut untuk mengirim Tiket Tugas.

1 Gunakan keypad untuk mengetik nomor ruang yang diinginkan. Tekan  untuk memilih.

2 Tekan  atau  ke Status Ruang. Tekan  untuk memilih.

3 Tekan  atau  ke opsi yang diinginkan.

Tekan  untuk memilih.

4 Tekan  atau  ke Kirim. Tekan  untuk memilih.

Layar menampilkan pemberitahuan mini transisional, yang menunjukkan permintaan sedang diproses.

5 Tunggu respons.

Jika berhasil:

- Nada indikator positif akan berbunyi.
- Layar menampilkan pemberitahuan mini positif.

Jika tidak berhasil:

- Nada indikator negatif akan berbunyi.
 - Layar menampilkan pemberitahuan mini negatif.
-

Mengirim Tiket Tugas Menggunakan Lebih Dari Satu Template Tiket Tugas

Jika radio Anda dikonfigurasi dengan lebih dari satu template Tiket Tugas, lakukan tindakan berikut untuk mengirim Tiket Tugas.

- 1 Tekan  atau  ke opsi yang diinginkan.

Tekan  untuk memilih.

- 2 Tekan  atau  ke Kirim. Tekan  untuk memilih.

Layar menampilkan pemberitahuan mini transisional, yang menunjukkan permintaan sedang diproses.

- 3 Tunggu respons.

Jika berhasil:

- Nada indikator positif akan berbunyi.
- Layar menampilkan pemberitahuan mini positif.

Jika tidak berhasil:

- Nada indikator negatif akan berbunyi.



- Layar menampilkan pemberitahuan mini negatif.
-

Menghapus Tiket Tugas

Ikuti prosedur untuk menghapus tiket tugas di radio Anda.



- 1 Lakukan salah satu langkah berikut:

- Tekan tombol **Tiket Tugas** terprogram. Lanjutkan ke [langkah 4](#)
 - Tekan  untuk mengakses menu.
-

- 2 Tekan  atau  ke Tiket Tugas. Tekan  untuk memilih.
-

- 3 Tekan  atau  ke folder yang diinginkan. Tekan  untuk memilih.
-

- 4 Tekan  atau  ke Semua folder. Tekan  untuk memilih.
-

5 Tekan  atau  ke Tiket Tugas yang diinginkan. Tekan  untuk memilih.

6 Tekan  lagi sewaktu menampilkan Tiket Tugas.

7 Tekan  atau  ke Hapus. Tekan  untuk memilih.

Layar menampilkan pemberitahuan mini transisional, yang menunjukkan permintaan sedang diproses.

8 Tunggu respons.

Jika berhasil:

- Nada indikator positif akan berbunyi.
- Layar menampilkan pemberitahuan mini positif.

Jika tidak berhasil:

- Nada indikator negatif akan berbunyi.
 - Layar menampilkan pemberitahuan mini negatif.
-



Menghapus Semua Tiket Tugas

Ikuti prosedur untuk menghapus semua tiket tugas di radio Anda.



1 Lakukan salah satu langkah berikut:

- Tekan tombol **Tiket Tugas** terprogram. Lanjutkan ke [langkah 3](#).
 - Tekan  untuk mengakses menu.
-







2 Tekan  atau  ke Tiket Tugas. Tekan  untuk memilih.

3 Tekan  atau  ke folder yang diinginkan. Tekan  untuk memilih.

4 Tekan  atau  ke Semua folder. Tekan  untuk memilih.

5 Tekan  atau  ke Hapus Semua. Tekan  untuk memilih.

6 Lakukan salah satu langkah berikut:

- Tekan  atau  ke Ya. Tekan  untuk memilih.
Layar menampilkan pemberitahuan mini positif.
- Tekan  atau  ke Tidak. Tekan  untuk memilih.
Radio kembali ke layar sebelumnya.

Privasi

Fitur ini membantu mencegah pengguna yang tidak sah menguping di saluran menggunakan solusi pengacakan berbasis perangkat lunak. Transmisi pengiriman sinyal dan identifikasi pengguna tidak diacak.

Privasi pada radio Anda harus diaktifkan pada saluran tersebut untuk mengirim transmisi dengan privasi diaktifkan, meskipun ini bukan persyaratan yang perlu untuk menerima transmisi. Ketika berada pada saluran dengan privasi diaktifkan, radio masih bisa menerima transmisi yang jernih atau tanpa diacak.

Model radio tertentu belum tentu mempunyai fitur Privasi, atau mempunyai konfigurasi berbeda. Tanyakan kepada

penyalur atau administrator sistem Anda untuk informasi lebih lanjut.

Radio Anda mendukung dua jenis privasi, tetapi hanya satu yang dapat dialokasikan ke radio Anda. Kotak tersebut adalah:

- Privasi Dasar
- Privasi Ditingkatkan

Untuk menghilangkan pengacakan pada panggilan atau transmisi data dengan privasi diaktifkan, radio harus diprogram agar memiliki Kunci Privasi yang sama, atau Nilai Kunci dan ID Kunci yang sama dengan radio yang melakukan transmisi untuk Privasi Ditingkatkan.

Jika radio menerima panggilan teracak yang berbeda Kunci Privasi, atau yang berbeda Nilai Kunci dan ID Kunci, Anda akan mendengar transmisi yang kacau untuk Privasi Dasar atau tidak akan mendengar apa-apa untuk Privasi Ditingkatkan.

Pada saluran yang mengaktifkan privasi, radio dapat menerima panggilan jernih atau tanpa diacak, tergantung pemrograman radio Anda. Selain itu, radio mungkin memutar nada peringatan atau tidak, tergantung pemrogramannya.

LED hijau akan menyala saat radio melakukan transmisi dan akan berkedip dengan cepat saat radio menerima transmisi yang berlangsung dengan privasi diaktifkan.



PEMBERITAHUAN:

Fitur ini tidak tersedia dalam saluran Citizens Band yang berada dalam frekuensi yang sama.

Mengaktifkan atau Menonaktifkan Privasi









Ikuti prosedur untuk mengaktifkan atau menonaktifkan privasi di radio Anda.

- 1 Lakukan salah satu langkah berikut:
 - Tekan tombol terprogram **Privasi**. Lompatilah langkah-langkah di bawah ini.
 - Tekan  untuk mengakses menu.

- 2 Tekan  atau  ke **Utilitas**. Tekan  untuk memilih.

- 3 Tekan  atau  ke **Pengaturan Radio**. Tekan  untuk memilih.

- 4 Tekan  atau  ke **Privasi**. Tekan  untuk memilih.

- 5 Lakukan salah satu langkah berikut:
 - Tekan  atau  ke **Aktif**. Tekan  untuk memilih. Layar menampilkan  di sebelah **Aktif**.
 - Tekan  atau  ke **Nonaktif**. Tekan  untuk memilih. Layar menampilkan  di sebelah **Nonaktif**.

Larangan Tanggapan

Fitur ini mencegah radio menanggapi transmisi masuk.



PEMBERITAHUAN:

Fitur ini dapat dibeli. Tanyakan kepada dealer atau administrator sistem Anda untuk mengetahui bagaimana radio Anda diprogram.

Jika aktif, radio tidak menghasilkan transmisi keluar untuk menanggapi transmisi masuk, seperti Pemeriksaan Radio, Peringatan Panggilan, Penonaktifan Radio, Monitor Jarak Jauh, Layanan Pendaftaran Otomatis (ARS), Penanganan Pesan Pribadi, dan Pengiriman laporan lokasi GNSS. Saat fitur ini aktif, radio tidak dapat menerima Panggilan Pribadi yang Dikonfirmasi. Namun, radio dapat mengirim transmisi secara manual.

Menonaktifkan atau Menonaktifkan Larangan Tanggapan

Ikuti prosedur untuk mengaktifkan atau menonaktifkan Larangan Tanggapan di radio.

Tekan tombol terprogram **Larangan Tanggapan**.

Jika berhasil:

- Nada indikator positif akan berbunyi.
- Layar menampilkan pemberitahuan mini positif.

Jika tidak berhasil:

- Nada indikator negatif akan berbunyi.
- Layar menampilkan pemberitahuan mini negatif.

Kontrol Multisite

Fitur ini berlaku bila saluran radio aktif merupakan bagian dari konfigurasi IP Site Connect atau konfigurasi Capacity Plus–Multi-Site.

Memulai Pencarian Site Manual

Ikuti prosedur untuk memulai pencarian site manual saat kekuatan sinyal yang diterima lemah untuk mencoba menemukan site dengan sinyal yang lebih baik.

Jika radio menemukan site baru:

- Nada indikator positif akan berbunyi.

Jika radio gagal menemukan site baru:

- Nada indikator negatif akan berbunyi.

Kunci Site Aktif/Nonaktif

Ketika diaktifkan, radio akan mencari site saat ini saja.
Ketika dinonaktifkan, radio akan mencari site lain di samping site saat ini.

Tekan tombol **Kunci Site**.

Jika fungsi **Kunci Site** diaktifkan:

- Anda mendengar nada indikator positif, yang menunjukkan radio telah dikunci ke site saat ini.
- Layar akan menampilkan Site Terkunci.

Jika fungsi **Kunci Site** dinonaktifkan:

- Anda mendengar nada indikator negatif, menandakan bahwa radio tidak terkunci.
- Layar akan menampilkan Site Tidak Terkunci.

Mengakses Daftar Site Tetangga

Fitur ini memungkinkan pengguna memeriksa daftar site yang bersebelahan pada site asal saat ini. Ikuti prosedur untuk mengakses Daftar Site Tetangga:

- 1 Tekan  untuk mengakses menu.
- 2 Tekan  atau  ke Utilitas. Tekan  untuk memilih.
- 3 Tekan  atau  ke Info Radio. Tekan  untuk memilih.
- 4 Tekan  atau  ke Site Tetangga. Tekan  untuk memilih.

Keamanan

Fitur ini memungkinkan Anda mengaktifkan atau menonaktifkan radio di dalam sistem.

Misalnya, Anda ingin menonaktifkan radio yang dicuri agar pengguna yang tidak sah tidak dapat menggunakannya, dan mengaktifkan radio tersebut ketika sudah ditemukan.

Ada dua cara untuk mengaktifkan atau menonaktifkan radio, dengan dan tanpa autentikasi.

Fitur Penonaktifan Radio dengan Autentikasi dapat dibeli. Di Penonaktifan Radio dengan Autentikasi, Anda harus melakukan verifikasi saat mengaktifkan atau menonaktifkan radio. Saat radio menerapkan fitur ini ke radio target dengan Autentikasi Pengguna, frasa sandi diperlukan. Frasa sandi sudah diprogram sebelumnya ke radio target melalui CPS.

Anda tidak akan menerima respons jika menekan  selama proses Pengaktifan Radio atau Penonaktifan Radio.



PEMBERITAHUAN:

Tanyakan kepada penyalur atau administrator sistem Anda untuk informasi lebih lanjut.

Menonaktifkan Radio

Ikuti prosedur untuk menonaktifkan radio.

1 Tekan tombol **Penonaktifan Radio** terprogram.

2 Tekan  atau  ke alias atau ID yang diinginkan.

3 Tekan  untuk memilih. Salah satu skenario berikut ini akan terjadi:

- Layar menampilkan pemberitahuan mini transisional, yang menunjukkan permintaan sedang diproses. LED akan berkedip hijau.
- Akan muncul layar frase sandi.

Masukkan frase sandi. Tekan  untuk melanjutkan.

- Jika frase sandi benar, layar menampilkan pemberitahuan mini transisional, yang menunjukkan permintaan sedang diproses. LED hijau akan menyala.
- Jika frase sandi salah, layar menampilkan pemberitahuan mini negatif, dan Anda akan kembali ke layar sebelumnya.

4 Tunggu respons.

Jika berhasil:











- Nada indikator positif akan berbunyi.
- Layar menampilkan pemberitahuan mini positif.

Jika tidak berhasil:

- Nada indikator negatif akan berbunyi.
 - Layar menampilkan pemberitahuan mini negatif.
-

Menonaktifkan Radio Menggunakan Daftar Kontak 📞

Ikuti prosedur untuk menonaktifkan radio menggunakan daftar Kontak.

- 1 Tekan  untuk mengakses menu.
- 2 Tekan  atau  ke Kontak. Tekan  untuk memilih.
- 3 Tekan  atau  ke alias atau ID yang diinginkan. Tekan  untuk memilih.
- 4 Tekan  atau  ke Penonaktifan Radio.
- 5 Tekan  untuk memilih. Salah satu skenario berikut ini akan terjadi:

- Layar menampilkan pemberitahuan mini transisional, yang menunjukkan permintaan sedang diproses. LED akan berkedip hijau.
- Akan muncul layar frase sandi.

Masukkan frase sandi. Tekan  untuk melanjutkan.

- Jika frasa sandi benar, layar menampilkan pemberitahuan mini transisional, yang menunjukkan permintaan sedang diproses. LED hijau akan menyala.
 - Jika frase sandi salah, layar menampilkan pemberitahuan mini negatif, dan Anda akan kembali ke layar sebelumnya.
-

6 Tunggu respons.

Jika berhasil:

- Nada indikator positif akan berbunyi.
- Layar menampilkan pemberitahuan mini positif.



Jika tidak berhasil:



- Nada indikator negatif akan berbunyi.
 - Layar menampilkan pemberitahuan mini negatif.
-



Menonaktifkan Radio Menggunakan Panggilan Manual

Ikuti prosedur untuk menonaktifkan radio menggunakan panggilan manual.

- 1 Tekan  untuk mengakses menu.

- 2 Tekan  atau  ke Kontak. Tekan  untuk memilih.

- 3 Tekan  atau  ke Panggilan Manual. Tekan  untuk memilih.

- 4 Tekan  atau  ke Nomor Radio. Tekan  untuk memilih.
Baris teks pertama menampilkan Nomor Radio:.

- 5 Masukkan ID subscriber, lalu tekan  untuk melanjutkan.

- 6 Tekan  atau  ke Penonaktifan Radio.

- 7 Tekan  untuk memilih. Salah satu skenario berikut ini akan terjadi:
 - Layar menampilkan pemberitahuan mini transisional, yang menunjukkan permintaan sedang diproses. LED akan berkedip hijau.
 - Akan muncul layar frase sandi.

Masukkan frase sandi. Tekan  untuk melanjutkan.

 - Jika frasa sandi benar, layar menampilkan pemberitahuan mini transisional, yang menunjukkan permintaan sedang diproses. LED hijau akan menyala.
 - Jika frase sandi salah, layar menampilkan pemberitahuan mini negatif, dan Anda akan kembali ke layar sebelumnya.

- 8 Tunggu respons.
Jika berhasil:
 - Nada indikator positif akan berbunyi.

- Layar menampilkan pemberitahuan mini positif.

Jika tidak berhasil:

- Nada indikator negatif akan berbunyi.
 - Layar menampilkan pemberitahuan mini negatif.
-

Mengaktifkan Radio

Ikuti prosedur untuk mengaktifkan radio.

1 Tekan tombol **Pengaktifan Radio** yang terprogram.

2 Tekan  atau  ke alias atau ID yang diinginkan.

3 Tekan  untuk memilih. Salah satu skenario berikut ini akan terjadi:

- Layar menampilkan Pengaktifan Radio dan alias atau ID subscriber. LED hijau akan menyala.
- Akan muncul layar frase sandi.

Masukkan frase sandi. Tekan  untuk melanjutkan.

- Jika frasa sandi benar, layar menampilkan pemberitahuan mini transisional, yang menunjukkan permintaan sedang diproses. LED hijau akan menyala.
 - Jika frase sandi salah, layar menampilkan pemberitahuan mini negatif, dan Anda akan kembali ke layar sebelumnya.
-

4 Tunggu respons.

Jika berhasil:

- Nada indikator positif akan berbunyi.
- Layar menampilkan pemberitahuan mini positif.



Jika tidak berhasil:

- Nada indikator negatif akan berbunyi.
 - Layar menampilkan pemberitahuan mini negatif.
-

Mengaktifkan Radio Menggunakan Daftar Kontak

Ikuti prosedur untuk mengaktifkan radio menggunakan daftar Kontak.

- 1 Tekan  untuk mengakses menu.

- 2 Tekan  atau  ke Kontak. Tekan  untuk memilih.

- 3 Tekan  atau  ke alias atau ID yang diinginkan. Tekan  untuk memilih.

- 4 Tekan  atau  ke Pengaktifan Radio.

- 5 Tekan  untuk memilih. Salah satu skenario berikut ini akan terjadi:
 - LED akan berkedip hijau. Layar menampilkan Pengaktifan Radio dan alias atau ID subscriber. LED hijau akan menyala.
 - Akan muncul layar frase sandi.

Masukkan frase sandi. Tekan  untuk melanjutkan.

- Jika frasa sandi benar, layar menampilkan pemberitahuan mini transisional, yang menunjukkan permintaan sedang diproses. LED hijau akan menyala.
- Jika frase sandi salah, layar menampilkan pemberitahuan mini negatif, dan Anda akan kembali ke layar sebelumnya.

6 Tunggu respons.

Jika berhasil:

- Nada indikator positif akan berbunyi.
- Layar menampilkan pemberitahuan mini positif.

Jika tidak berhasil:

- Nada indikator negatif akan berbunyi.
- Layar menampilkan pemberitahuan mini negatif.

Mengaktifkan Radio Menggunakan Panggilan Manual

Ikuti prosedur untuk mengaktifkan radio menggunakan panggilan manual.

- 1 Tekan  untuk mengakses menu.

- 2 Tekan  atau  ke Kontak. Tekan  untuk memilih.

- 3 Tekan  atau  ke Panggilan Manual. Tekan  untuk memilih.

- 4 Tekan  atau  ke Panggilan Pribadi. Tekan  untuk memilih. Baris teks pertama menampilkan Nomor Radio:.

- 5 Masukkan ID subscriber, lalu tekan  untuk melanjutkan.

- 6 Tekan  atau  ke Pengaktifan Radio.

- 7 Tekan  untuk memilih. Salah satu skenario berikut ini akan terjadi:
 - LED akan berkedip hijau. Layar menampilkan Pengaktifan Radio dan alias atau ID subscriber. LED hijau akan menyala.
 - Akan muncul layar frase sandi.

Masukkan frase sandi. Tekan  untuk melanjutkan.

 - Jika frasa sandi benar, layar menampilkan pemberitahuan mini transisional, yang menunjukkan permintaan sedang diproses. LED hijau akan menyala.
 - Jika frase sandi salah, layar menampilkan pemberitahuan mini negatif, dan Anda akan kembali ke layar sebelumnya.

- 8 Tunggu respons.

Jika berhasil:

- Nada indikator positif akan berbunyi.

- Layar menampilkan pemberitahuan mini positif.

Jika tidak berhasil:

- Nada indikator negatif akan berbunyi.
- Layar menampilkan pemberitahuan mini negatif.

Pekerja Terpisah

Fitur ini memicu keadaan darurat yang akan muncul jika tidak ada aktivitas pengguna, seperti penekanan tombol radio atau pemilihan saluran, selama waktu yang ditentukan sebelumnya.

Setelah tidak ada aktivitas pengguna selama durasi terprogram, radio sebelumnya mengingatkan pengguna melalui indikator audio setelah pengatur waktu nonaktif habis.

Jika tetap tidak ada respons oleh pengguna sebelum pengatur waktu pengingat yang ditetapkan sebelumnya habis, radio menginisiasi Alarm Darurat.

Hanya salah satu dari Alarm Darurat berikut ditetapkan pada fitur ini:

- Alarm Darurat
- Alarm Darurat dengan Panggilan

- Alarm Darurat dengan Suara untuk Diikuti 

Radio tetap dalam status darurat yang memungkinkan pesan suara untuk dilanjutkan sampai diambil suatu tindakan. Lihat [Pengoperasian Darurat di halaman 438](#) untuk informasi selengkapnya tentang cara keluar dari mode Darurat.



PEMBERITAHUAN:

Fitur ini terbatas pada radio dengan fungsi ini yang diaktifkan. Tanyakan kepada penyalur atau administrator sistem Anda untuk informasi lebih lanjut.

Bluetooth

Fitur ini memungkinkan Anda untuk menggunakan radio dengan perangkat (aksesori) Bluetooth melalui sambungan Bluetooth. Radio mendukung perangkat Bluetooth dari Motorola Solutions dan COTS (Commercially available Off-The-Shelf).

Bluetooth beroperasi dalam jarak pandang sejauh 10 m (32 kaki). Ini adalah jalur tanpa hambatan antara radio Anda dan perangkat berkemampuan Bluetooth. Untuk keandalan tingkat tinggi, Motorola Solutions menyarankan untuk tidak memisahkan radio dan aksesori.

Di area batas penerimaan, kualitas suara dan nada mulai terdengar "samar" atau "terputus-putus". Untuk mengatasi masalah ini, dekatkan posisi radio dan perangkat berkemampuan Bluetooth (dalam jarak 10 m yang telah ditetapkan) untuk menghasilkan kembali penerimaan audio yang jernih. Fungsi Bluetooth pada radio mempunyai daya maksimum 2,5 mW (4 dBm) dengan jangkauan 10 m.

Radio dapat mendukung hingga tiga sambungan Bluetooth secara bersamaan dengan perangkat Bluetooth dari jenis yang berbeda. Misalnya, headset, pemindai, dan PTT-Only Device (POD). Beberapa sambungan dengan jenis perangkat berkemampuan Bluetooth dari tipe yang sama tidak didukung.

Lihat panduan pengguna untuk perangkat berkemampuan Bluetooth Anda untuk informasi selengkapnya tentang kapabilitas penuh dari perangkat berkemampuan Bluetooth Anda.







PEMBERITAHUAN:





Jika dinonaktifkan melalui CPS, semua fitur terkait Bluetooth akan dinonaktifkan dan database perangkat Bluetooth dihapus.





Mengaktifkan dan Menonaktifkan Bluetooth





Ikuti prosedur untuk mengaktifkan dan menonaktifkan Bluetooth.

- 1 Tekan  untuk mengakses menu.

- 2 Tekan  atau  ke Bluetooth. Tekan  untuk memilih.

- 3 Tekan  atau  ke Status Saya. Tekan  untuk memilih.
Layar akan menampilkan Aktif dan Nonaktif. Status saat ini ditunjukkan oleh .







- 4 Lakukan salah satu langkah berikut:
 - Tekan  atau  ke Aktif. Tekan  untuk memilih. Layar menampilkan  di sebelah Aktif.









- Tekan  atau  ke Nonaktif. Tekan  untuk memilih. Layar menampilkan  di sebelah Nonaktif.

Menghubungkan ke Perangkat Bluetooth

Ikuti prosedur untuk menghubungkan dengan perangkat Bluetooth.

Hidupkan perangkat berkemampuan Bluetooth dan alihkan ke mode pasangan.

- 1 Tekan  untuk mengakses menu.
- 2 Tekan  atau  ke Bluetooth. Tekan  untuk memilih.
- 3 Tekan  atau  ke Perangkat. Tekan  untuk memilih.
- 4 Lakukan salah satu langkah berikut:

- Tekan  atau  ke perangkat yang diinginkan. Tekan  untuk memilih.
- Tekan  atau  ke Cari Perangkat untuk mencari perangkat yang tersedia. Tekan  atau  ke perangkat yang diinginkan. Tekan  untuk memilih.

- 5 Tekan  atau  ke Hubungkan. Tekan  untuk memilih.

Perangkat berkemampuan Bluetooth mungkin memerlukan langkah-langkah tambahan untuk menyelesaikan pemasangan. Baca panduan pengguna tentang perangkat berkemampuan Bluetooth.

Layar menampilkan Menyambung ke <Perangkat>.

Tunggu respons.
Jika berhasil:

- Nada indikator positif akan berbunyi.
- Layar menampilkan <Perangkat> Terhubung dan ikon **Bluetooth Terhubung**.

- Layar menampilkan ✓ di sebelah perangkat yang terhubung.

Jika tidak berhasil:

- Nada indikator negatif akan berbunyi.
- Layar menampilkan Gagal Menghubungkan.



PEMBERITAHUAN:

Jika memerlukan kode PIN, lihat [Mengakses Radio Menggunakan Kata Sandi di halaman 191](#).



Menghubungkan ke Perangkat Bluetooth dalam Mode Dapat Ditemukan

Ikuti prosedur untuk menyambung ke perangkat Bluetooth dalam mode dapat ditemukan.

Hidupkan perangkat berkemampuan Bluetooth dan alihkan ke mode pasangan.

1 Tekan  untuk mengakses menu.

2 Tekan  atau  ke Bluetooth. Tekan  untuk memilih.

3 Tekan  atau  ke Temukan Saya. Tekan  untuk memilih. Sekarang radio dapat ditemukan oleh perangkat lain yang berkemampuan Bluetooth selama durasi yang diprogram. Ini disebut Mode Dapat Ditemukan.

Tunggu respons.

Jika berhasil:

- Nada indikator positif akan berbunyi.
- Layar menampilkan <Perangkat> Terhubung dan ikon **Bluetooth Terhubung**.
- Layar menampilkan ✓ di sebelah perangkat yang terhubung.



Jika tidak berhasil:



- Nada indikator negatif akan berbunyi.
- Layar menampilkan Gagal Menghubungkan.



Memutuskan Sambungan dari Perangkat Bluetooth



Ikuti prosedur untuk memutus koneksi dengan perangkat Bluetooth.

- 1 Tekan  untuk mengakses menu.

- 2 Tekan  atau  ke Bluetooth. Tekan  untuk memilih.

- 3 Tekan  atau  ke Perangkat. Tekan  untuk memilih.

- 4 Tekan  atau  ke perangkat yang diinginkan. Tekan  untuk memilih.

- 5 Tekan  atau  ke Putuskan Sambungan. Tekan  untuk memilih.
Layar menampilkan Memutuskan dari <Perangkat>.



PEMBERITAHUAN:

Perangkat berkemampuan Bluetooth Anda mungkin memerlukan langkah tambahan untuk memutuskan sambungan. Baca panduan pengguna masing-masing untuk perangkat berkemampuan Bluetooth.

Tunggu respons.

- Nada akan berbunyi.
- Layar menampilkan <Perangkat> Terputus dan ikon **Bluetooth Terhubung** hilang.
- Ikon  hilang dari sebelah perangkat yang terhubung.

Mengalihkan Rute Audio antara Speaker Radio Internal dan Perangkat Bluetooth

Ikuti prosedur untuk mengalihkan rute audio antara speaker internal radio dan perangkat Bluetooth eksternal.











Tekan tombol terprogram **Sakelar Audio Bluetooth**.



Layar menampilkan salah satu hasil berikut ini:

- Nada akan berbunyi. Layar menampilkan **Rutekan Audio ke Radio**.
- Nada akan berbunyi. Layar menampilkan **Rutekan Audio ke Bluetooth**.

Melihat Detail Perangkat











Ikuti prosedur untuk melihat detail perangkat di radio.

- 1 Tekan  untuk mengakses menu.
- 2 Tekan  atau  ke Bluetooth. Tekan  untuk memilih.
- 3 Tekan  atau  ke Perangkat. Tekan  untuk memilih.
- 4 Tekan  atau  ke perangkat yang diinginkan. Tekan  untuk memilih.

- 5 Tekan  atau  ke Lihat Detail. Tekan  untuk memilih.

Menghapus Nama Perangkat











Anda dapat menghapus perangkat yang diputus sambungannya dari daftar perangkat berkemampuan Bluetooth.



- 1 Tekan  untuk mengakses menu.
- 2 Tekan  atau  ke Bluetooth. Tekan  untuk memilih.
- 3 Tekan  atau  ke Perangkat. Tekan  untuk memilih.
- 4 Tekan  atau  ke perangkat yang diinginkan. Tekan  untuk memilih.

- 5 Tekan  atau  ke Hapus. Tekan  untuk memilih. Layar menampilkan Perangkat Dihapus.
-

Penguatan Mikrofon Bluetooth

Dengan fitur ini, pengguna dapat mengontrol nilai penguatan mikrofon pada perangkat berkemampuan Bluetooth yang terhubung.

- 1 Tekan  untuk mengakses menu.
-
- 2 Tekan  atau  ke Bluetooth. Tekan  untuk memilih.
-
- 3 Tekan  atau  ke Penguatan Mik BT. Tekan  untuk memilih.
-
- 4 Tekan  atau  ke jenis Penguatan Mik BT dan nilai saat ini. Tekan  untuk memilih. Anda dapat mengedit nilai di sini.
-

- 5 Tekan  atau  untuk menambah atau mengurangi nilai. Tekan  untuk memilih.
-

Lokasi Dalam Ruangan









PEMBERITAHUAN:

Fitur Lokasi Dalam Ruangan hanya berlaku untuk model dengan perangkat lunak dan perangkat keras terbaru. Tanyakan kepada penyalur atau administrator sistem Anda untuk informasi lebih lanjut.

Lokasi Dalam Ruangan digunakan untuk terus melacak lokasi pengguna radio. Apabila Lokasi Dalam Ruangan diaktifkan, radio berada dalam mode dapat ditemukan terbatas. Suar terdedikasi digunakan untuk menemukan lokasi radio dan menentukan posisinya.

Mengaktifkan atau Menonaktifkan Lokasi Dalam Ruangan

Anda dapat mengaktifkan atau menonaktifkan Lokasi Dalam Ruangan dengan melakukan satu tindakan berikut ini.

- Akses fitur ini melalui menu.
 - a. Tekan  untuk mengakses menu.
 - b. Tekan  atau  ke Bluetooth dan tekan  untuk memilih.
 - c. Tekan  atau  ke Lokasi Dalam Ruangan dan tekan  untuk memilih.
 - d. Tekan  untuk mengaktifkan Lokasi Dalam Ruangan.
Layar menampilkan Lokasi Dalam Ruangan Aktif. Anda mendengarkan nada indikator positif.
Salah satu skenario berikut ini akan terjadi.

- Jika berhasil, ikon Lokasi Dalam Ruangan Tersedia akan muncul di tampilan layar Awal.
- Jika tidak berhasil, layar menampilkan Pengaktifan Gagal. Anda mendengarkan nada indikator negatif.

- e. Tekan  untuk menonaktifkan Lokasi Dalam Ruangan.

Layar menampilkan Lokasi Dalam Ruangan Nonaktif. Anda mendengarkan nada indikator positif.

Salah satu skenario berikut ini akan terjadi.

- Jika berhasil, ikon Lokasi Dalam Ruangan Tersedia akan hilang dari tampilan layar Awal.
- Jika tidak berhasil, layar menampilkan Penonaktifan Gagal. Anda mendengarkan nada indikator negatif.

- Akses fitur ini menggunakan tombol terprogram.

- a. Tekan lama tombol **Lokasi Dalam Ruangan** terprogram untuk mengaktifkan Lokasi Dalam Ruangan.

Layar menampilkan Lokasi Dalam Ruangan Aktif. Anda mendengarkan nada indikator positif.

Salah satu skenario berikut ini akan terjadi.

- Jika berhasil, ikon Lokasi Dalam Ruangan Tersedia akan muncul di tampilan layar Awal.
- Jika tidak berhasil, layar menampilkan Pengaktifan Gagal. Jika tidak berhasil, Anda akan mendengar nada indikator negatif.

- b. Tekan tombol **Lokasi Dalam Ruangan** terprogram untuk menonaktifkan Lokasi Dalam Ruangan.

Layar menampilkan Lokasi Dalam Ruangan Nonaktif. Anda mendengarkan nada indikator positif.

Salah satu skenario berikut ini akan terjadi.



- Jika berhasil, ikon Lokasi Dalam Ruangan Tersedia akan hilang dari tampilan layar Awal.



- Jika tidak berhasil, layar menampilkan Penonaktifan Gagal. Jika tidak berhasil, Anda akan mendengar nada indikator negatif.



Mengakses Informasi Suar Lokasi Dalam Ruangan

Ikuti prosedur untuk mengakses informasi suar Lokasi Dalam Ruangan.

- 1 Tekan  untuk mengakses menu.

- 2 Tekan  atau  ke Bluetooth dan tekan  untuk memilih.

- 3 Tekan  atau  ke Lokasi Dalam Ruangan dan tekan  untuk memilih.

- 4 Tekan  atau  ke Suar dan tekan  untuk memilih.

Layar menampilkan informasi suar.

Daftar Notifikasi

Radio Anda dilengkapi daftar Pemberitahuan yang akan mengumpulkan semua aktivitas yang belum dibaca pada saluran, misalnya pesan teks yang belum dibaca, pesan telemetri, panggilan tidak terjawab, dan peringatan panggilan.

Layar menampilkan ikon **Notifikasi** ketika terdapat satu atau lebih kejadian dalam daftar Notifikasi.

Daftar ini mendukung maksimal 40 kejadian tak terbaca. Jika daftar penuh, kejadian selanjutnya menggantikan kejadian paling lama secara otomatis. Setelah dibaca, kejadian dihapus dari daftar Notifikasi.



Untuk aktivitas pesan teks, panggilan tidak terjawab, peringatan panggilan, jumlah maksimum pemberitahuan adalah 30 pesan teks dan 10 panggilan tidak terjawab atau peringatan panggilan. Jumlah maksimum ini akan tergantung pada kemampuan daftar fitur (tiket tugas, pesan teks, atau panggilan tidak terjawab atau peringatan panggilan).

Mengakses Daftar Notifikasi

Ikuti prosedur untuk mengakses daftar Notifikasi di radio Anda.

1 Tekan  untuk mengakses menu.

2 Tekan  atau  ke Notifikasi. Tekan  untuk memilih.

3 Tekan  atau  ke kejadian yang diperlukan. Tekan  untuk memilih.

Tekan lama  untuk kembali ke layar Awal.

Sistem Transponder Auto-Range

Sistem Transponder Auto-Range (ARTS) adalah fitur khusus analog yang didesain untuk memberitahu Anda saat radio berada di luar jangkauan radio lain yang dilengkapi dengan ARTS.

Radio yang dilengkapi ARTS mengirim transmisi atau menerima sinyal secara berkala untuk mengonfirmasi bahwa radio berada dalam jangkauan masing-masing.

Radio Anda menunjukkan status sebagai berikut:

Peringatan Pertama Kali

Nada akan berbunyi.

Layar menampilkan Dalam Jangkauan setelah alias saluran.

Peringatan ARTS di Dalam Jangkauan

Jika diprogram, akan terdengar nada.

Layar menampilkan Dalam Jangkauan setelah alias saluran.

Peringatan ARTS di Luar Jangkauan

Nada akan berbunyi. LED berwarna merah berkedip dengan cepat.

Layar menampilkan Di Luar Jangkauan bergantian dengan Layar utama.



PEMBERITAHUAN:

Tanyakan kepada penyalur atau administrator sistem Anda untuk informasi lebih lanjut.

Pemrograman Melalui Udara

Dealer dapat memperbarui radio Anda dari jauh melalui Over-the-Air Programming (OTAP) tanpa koneksi fisik apa pun. Selain itu, beberapa pengaturan juga dapat dikonfigurasi menggunakan OTAP.

Ketika radio melakukan OTAP, LED hijau berkedip.

Ketika radio menerima data volume tinggi:

- Layar menampilkan ikon **Data Volume Tinggi**.
- Saluran menjadi sibuk.
- Nada negatif akan berbunyi jika Anda menekan tombol **PTT**.

Setelah OTAP selesai, tergantung pada konfigurasi:

- Nada akan berbunyi. Layar menampilkan Memulai Ulang Pembaruan. Radio memulai ulang dengan mati dan menyala lagi.
- Anda dapat memilih Mulai Ulang Sekarang atau Tunda. Jika Anda memilih Tunda, radio kembali ke layar sebelumnya. Layar menampilkan ikon **Pencatat Waktu Penundaan OTAP** sampai mulai ulang otomatis terjadi.

Jika radio menyala setelah mulai ulang otomatis:

- Jika berhasil, layar menampilkan Pembaruan Perangkat Lunak Selesai.
- Jika tidak berhasil, layar menampilkan Pembaruan Perangkat Lunak Gagal.

Lihat [Memeriksa Informasi Pembaruan Perangkat Lunak di halaman 228](#) untuk perangkat lunak versi terbaru.

Penghambat Transmisi

Fitur Penghambat Transmisi memungkinkan pengguna memblokir semua transmisi dari radio.





PEMBERITAHUAN:

Fitur Bluetooth dan Wi-Fi tersedia dalam mode Penghambat Transmisi.

Mengaktifkan Penghambat Transmisi

Ikuti prosedur untuk mengaktifkan Penghambat Transmisi.

Lakukan salah satu tindakan berikut:

- Tekan  atau  ke Penghambat Tx dan tekan  untuk memilih.
 - Tekan tombol **Penghambat Transmisi** yang dapat diprogram.
-
- Nada indikator positif akan berbunyi.
 - Layar menampilkan Penghambat Tx Aktif.





PEMBERITAHUAN:

Status Penghambat Transmisi tidak berubah setelah radio menyala.

Menonaktifkan Penghambat Transmisi

Ikuti prosedur untuk menonaktifkan Penghambat Transmisi.

Lakukan salah satu tindakan berikut:

- Tekan  atau  ke Penghambat Tx dan tekan  untuk memilih.
- Tekan tombol **Penghambat Transmisi** yang dapat diprogram.

-
- Nada indikator negatif akan berbunyi. Transmisi kembali ke operasi normal.
 - Layar menampilkan Penghambat Tx Nonaktif.

Memilih Mode Koneksi Periferal Pihak Ketiga

Ikuti prosedur untuk memilih salah satu mode koneksi periferal pihak ketiga berikut:

- Motorola Solutions
- PC dan Audio



- Aksesori Data
- Telemetri
- Generik

1 Tekan  untuk mengakses menu.

2 Tekan  atau  ke Utilitas. Tekan  untuk memilih.

3 Tekan  atau  ke Pengaturan Radio. Tekan  untuk memilih.

4 Tekan  atau  ke Jenis Kabel. Tekan  untuk memilih.

5 Tekan  atau  ke mode koneksi yang diinginkan. Tekan  untuk memilih.
Layar akan menampilkan mode koneksi yang dipilih.
Layar kembali ke menu sebelumnya.



Indikator Kekuatan Sinyal Penerimaan

Dengan fitur ini, Anda dapat melihat nilai Indikator Kekuatan Sinyal Diterima (RSSI).

Layar menampilkan ikon **RSSI** di sudut kanan atas. Lihat [Ikon Layar](#) untuk informasi selengkapnya tentang ikon **RSSI**.

Melihat Nilai RSSI

Pasang Mikrofon Keypad Navigasi 4 Arah (nomor komponen Motorola Solutions RMN5127_) ke radio Anda.

Pada layar awal, menggunakan Mikrofon Keypad Navigasi 4 Arah, tekan  tiga kali dan segera tekan  tiga kali.

Layar menampilkan nilai RSSI yang sekarang.

Untuk kembali ke layar awal, tekan dan tahan .

Fitur Kunci Kata Sandi

Fitur ini memungkinkan Anda membatasi akses ke radio dengan meminta kata sandi saat perangkat dinyalakan.

Anda dapat menggunakan mikrofon keypad atau tombol **Gulir Atas/Bawah** untuk memasukkan kata sandi.

Mengakses Radio Menggunakan Kata Sandi



Ikuti prosedur untuk mengakses radio menggunakan kata sandi.

- 1 Masukkan kata sandi empat digit yang Anda gunakan saat ini.



PEMBERITAHUAN:

Penggunaan sakelar kaki **Darurat** akan membatalkan masukan kata sandi untuk mengakses radio.

- Gunakan mikrofon keypad.
- Tekan  atau  untuk mengedit nilai numerik setiap digit, lalu tekan  untuk memasukkan dan berpindah ke digit selanjutnya.

- 2 Tekan  untuk memasukkan kata sandi.

Jika berhasil, radio akan menyala.

Jika tidak berhasil:

- Setelah upaya pertama dan kedua, layar menampilkan **Kata Sandi Salah**. Ulangi [langkah 1](#).
- Setelah tiga kali kesalahan kata sandi, layar menampilkan **Kata Sandi Salah** lalu **Radio Terkunci**. Nada akan berbunyi. LED kuning berkedip ganda. Radio masuk ke status terkunci selama 15 menit.



PEMBERITAHUAN:

Dalam keadaan terkunci, radio merespons masukan dari **Kenop Aktif/Nonaktif/Kontrol Volume** dan tombol **Lampu Latar** terprogram saja.

Membuka Kunci Radio dalam Status Terkunci

Radio Anda tidak dapat menerima panggilan dalam status terkunci. Ikuti prosedur untuk membuka kunci radio dalam status terkunci.

Lakukan salah satu langkah berikut:



- Jika radio dihidupkan, tunggu hingga 15 menit, lalu ulangi langkah-langkah tersebut dalam [Mengakses Radio Menggunakan Kata Sandi di halaman 191](#) untuk mengakses radio.
- Jika radio dimatikan, nyalakan radio. Radio memulai ulang pencatat waktu 15 menit untuk status terkunci. Nada akan berbunyi. LED kuning berkedip ganda. Layar menampilkan Radio Terkunci.



Tunggu selama 15 menit, lalu ulangi langkah-langkah tersebut dalam [Mengakses Radio Menggunakan Kata Sandi di halaman 191](#) untuk mengakses radio.



Mengaktifkan atau Menonaktifkan Kunci Kata Sandi



Ikuti prosedur untuk mengaktifkan atau menonaktifkan kunci kata sandi di radio Anda.

- 1 Tekan  untuk mengakses menu.

- 2 Tekan  atau  ke Utilitas. Tekan  untuk memilih.









- 3 Tekan  atau  ke Pengaturan Radio. Tekan  untuk memilih.

- 4 Tekan  atau  ke Kunci Kata Sandi. Tekan  untuk memilih.

- 5 Masukkan kata sandi empat digit yang Anda gunakan saat ini.
 - Gunakan mikrofon keypad.
 - Tekan  atau  untuk mengedit nilai numerik setiap digit, lalu tekan  untuk memasukkan dan berpindah ke digit selanjutnya. Nada indikator positif akan terdengar untuk setiap digit yang ditekan.

6 Tekan  untuk memasukkan kata sandi.
Jika kata sandi salah, layar menampilkan Kata Sandi Salah dan otomatis kembali ke menu sebelumnya.

7 Lakukan salah satu langkah berikut:

- Tekan  atau  ke Aktifkan. Tekan  untuk memilih.
Layar akan menampilkan  di sebelah Nyala.
 - Tekan  atau  ke Nonaktifkan. Tekan  untuk memilih.
Layar akan menampilkan  di sebelah Mati.
-

Mengganti Kata Sandi

Ikuti prosedur untuk mengganti kata sandi di radio Anda.

1 Tekan  untuk mengakses menu.

2 Tekan  atau  ke Utilitas. Tekan  untuk memilih.

3 Tekan  atau  ke Pengaturan Radio.
Tekan  untuk memilih.

4 Tekan  atau  ke Kunci Kata Sandi.
Tekan  untuk memilih.

5 Masukkan kata sandi empat digit saat ini, lalu tekan  untuk melanjutkan.
Jika kata sandi salah, layar menampilkan Kata Sandi Salah, dan otomatis kembali ke menu sebelumnya.

6 Tekan  atau  ke Ubah Kata Sandi.
Tekan  untuk memilih.

7 Masukkan kata sandi empat digit baru, lalu tekan  untuk melanjutkan.

- 8 Masukkan kembali kata sandi empat digit baru, lalu tekan  untuk melanjutkan.

Jika berhasil, layar menampilkan Kata Sandi Diubah.

Jika tidak berhasil, layar menampilkan Kata Sandi Tidak Cocok.

Layar kembali ke menu sebelumnya secara otomatis.

Konfigurasi Panel Depan

Anda dapat mengatur parameter fitur tertentu pada Konfigurasi Panel Depan (FPC) untuk meningkatkan penggunaan radio.



Masuk ke Mode Konfigurasi Panel Depan

Ikuti prosedur untuk masuk ke mode pemrograman panel depan di radio Anda.

Untuk kembali ke layar Awal, tekan lama  kapan saja.





- 1 Tekan  untuk mengakses menu.

- 2 Tekan  atau  ke Utilitas. Tekan  untuk memilih.

- 3 Tekan  atau  ke Program Radio. Tekan  untuk memilih.

Mengedit Parameter Mode FPP

Gunakan tombol berikut ini sesuai kebutuhan ketika menelusuri parameter fitur.

-   , – Gulir di antara opsi, naikkan/turunkan nilai, atau telusuri secara vertikal.
-  – Pilih opsi atau masuk ke sub-menu.
-  – Tekan sebentar untuk kembali ke menu sebelumnya atau keluar dari layar pilihan. Tekan lama untuk kembali ke layar Awal.

Pengoperasian Wi-Fi

Fitur ini memungkinkan Anda mengatur dan terhubung ke jaringan Wi-Fi. Wi-Fi mendukung pembaruan untuk firmware, codeplug, dan sumber daya radio seperti paket bahasa dan pengumuman suara.



PEMBERITAHUAN:

Fitur ini hanya berlaku untuk XiR M8668i/CM7668i saja.

Wi-Fi® adalah merek dagang terdaftar dari Wi-Fi Alliance®.

Radio Anda mendukung WEP/WPA/WPA2-Personal dan jaringan Wi-Fi WPA/WPA2-Enterprise.

Jaringan Wi-Fi WEP/WPA/WPA2-Personal

Menggunakan otentikasi berbasis kunci (kata sandi) yang dibagikan sebelumnya.

Kunci yang dibagikan sebelumnya bisa dimasukkan menggunakan menu atau CPS/RM.

Jaringan Wi-Fi WPA/WPA2-Enterprise

Menggunakan otentikasi berbasis sertifikat.

Radio Anda harus dikonfigurasi terlebih dahulu dengan sertifikat.



PEMBERITAHUAN:

Tanyakan kepada dealer atau administrator sistem Anda untuk terhubung ke jaringan Wi-Fi WPA/WPA2-Enterprise.

Tombol terprogram **Wi-Fi Aktif** atau **Nonaktif** dialokasikan oleh penyalur atau administrator sistem Anda. Tanyakan kepada dealer atau administrator sistem Anda untuk mengetahui bagaimana radio Anda diprogram.

Pengumuman Suara untuk tombol terprogram **Wi-Fi Aktif** atau **Nonaktif** dapat disesuaikan melalui CPS sesuai dengan kebutuhan pengguna. Tanyakan kepada penyalur atau administrator sistem Anda untuk informasi lebih lanjut.



PEMBERITAHUAN:









Anda dapat mengaktifkan atau menonaktifkan Wi-Fi dari jarak jauh menggunakan radio supervisor (lihat [Mengaktifkan atau Menonaktifkan Wi-Fi Menggunakan Radio Supervisor](#)). Tanyakan kepada penyalur atau administrator sistem Anda untuk informasi lebih lanjut.

Mengaktifkan atau Menonaktifkan Wi-Fi

Ikuti prosedur untuk mengaktifkan dan menonaktifkan Wi-Fi.

- 1 Tekan tombol terprogram **Wi-Fi Aktif** atau **Nonaktif**. Pengumuman Suara berbunyi ketika Wi-Fi Diaktifkan atau Wi-Fi Dinonaktifkan.
-

- 2 Akses fitur ini menggunakan menu.

- a Tekan  untuk mengakses menu.
- b Tekan  atau  ke **WiFi** dan tekan  untuk memilih.
- c Tekan  atau  ke **WiFi Aktif** dan tekan  untuk memilih.
- d Tekan  untuk mengaktifkan/menonaktifkan Wi-Fi.

Jika Wi-Fi diaktifkan, layar akan menampilkan  di sebelah **Diaktifkan**.

Jika Wi-Fi dinonaktifkan,  hilang dari sebelah **Diaktifkan**.

Mengaktifkan atau Menonaktifkan Wi-Fi dari Jarak Jauh Menggunakan Radio Khusus (Kontrol Individu)



Ikuti prosedur untuk mengaktifkan atau menonaktifkan Wi-Fi dari jarak jauh di Kontrol Individu (Satu ke Satu).



PEMBERITAHUAN:

Hanya radio dengan pengaturan CPS khusus yang mendukung fungsi ini, tanyakan kepada dealer atau administrator sistem Anda untuk informasi lebih lanjut.

- 1 Lakukan salah satu langkah berikut:

- Tekan lama tombol yang dapat diprogram. Gunakan keypad untuk memasukkan ID, dan tekan  untuk memilih. Lanjutkan ke [langkah 3](#).
 - Tekan  untuk mengakses menu.
-

- 2 Tekan  atau  ke **Kontak** dan tekan  untuk memilih.
-

3 Tekan  atau  ke Kontrol WiFi dan tekan  untuk memilih.

4 Tekan  atau  untuk memilih Nyala atau Mati.

5 Tekan  untuk memilih.

Jika berhasil, layar menampilkan pemberitahuan mini positif.

Jika gagal, layar menampilkan pemberitahuan mini negatif.

Mengaktifkan atau Menonaktifkan Wi-Fi dari Jarak Jauh Menggunakan Radio Khusus (Kontrol Grup)

Ikuti prosedur untuk mengaktifkan atau menonaktifkan Wi-Fi dari jarak jauh di Kontrol Grup (Satu ke Banyak).



PEMBERITAHUAN:

Hanya radio dengan pengaturan CPS khusus yang mendukung fungsi ini, tanyakan kepada dealer atau administrator sistem Anda untuk informasi lebih lanjut.

1 Tekan  untuk mengakses menu.

2 Tekan  atau  ke Kontak dan tekan  untuk memilih.

3 Tekan  atau  untuk memilih alias atau ID subscriber yang diinginkan.

4 Tekan  atau  ke Kontrol WiFi dan tekan  untuk memilih.

5 Tekan  atau  untuk memilih Nyala atau Mati.

- 6 Tekan  untuk memilih.

Jika berhasil, layar menampilkan Berhasil Dikirim.

Jika gagal, layar menampilkan pemberitahuan mini negatif.

Menghubungkan ke Titik Akses Jaringan

Ketika Wi-Fi diaktifkan, radio memindai dan menyambung ke titik akses jaringan.



PEMBERITAHUAN:



Anda juga dapat menyambung ke titik akses jaringan menggunakan menu.

Titik akses jaringan Wi-Fi WPA-Enterprise telah dikonfigurasi sebelumnya. Tanyakan kepada dealer atau administrator sistem Anda untuk mengetahui bagaimana radio Anda diprogram.

- 1 Tekan  untuk mengakses menu.

- 2 Tekan  atau  ke WiFi dan tekan  untuk memilih.



- 3 Tekan  atau  ke Jaringan dan tekan  untuk memilih.

- 4 Tekan  atau  ke titik akses jaringan dan tekan  untuk memilih.



PEMBERITAHUAN:

Untuk Wi-Fi WPA-Enterprise, jika titik akses jaringan tidak dikonfigurasi sebelumnya, opsi Hubungkan tidak tersedia.

- 5 Tekan  atau  ke Hubungkan dan tekan  untuk memilih.

- 6 Untuk Wi-Fi WPA-Personal, masukkan kata sandi dan tekan .

- 7 Untuk Wi-Fi WPA-Enterprise, kata sandi dikonfigurasi dengan RM.

Jika kata sandi yang dikonfigurasi sebelumnya benar, radio Anda otomatis akan terhubung ke titik akses jaringan yang dipilih.

Jika kata sandi yang dikonfigurasi sebelumnya salah, layar menampilkan Otentikasi Gagal, dan otomatis kembali ke menu sebelumnya.

Jika berhasil terhubung, radio menampilkan pemberitahuan dan titik akses jaringan disimpan ke dalam daftar profil.

Jika tidak berhasil terhubung, radio menampilkan layar pemberitahuan kegagalan sesaat dan otomatis kembali ke menu sebelumnya.

Memeriksa Status Koneksi Wi-Fi

Ikuti prosedur untuk memeriksa status Koneksi Wi-Fi.

Tekan tombol terprogram **Permintaan Status Wi-Fi** untuk mengetahui status koneksi menggunakan Pengumuman Suara. Pengumuman Suara berbunyi ketika Wi-Fi Dinonaktifkan, Wi-Fi Diaktifkan, tetapi tidak untuk Tidak Ada Koneksi atau Wi-Fi Aktif dengan Koneksi.

- Layar menampilkan WiFi Nonaktif saat Wi-Fi nonaktif.
- Layar menampilkan WiFi Aktif, Tersambung saat radio tersambung ke jaringan.

- Layar menampilkan WiFi Aktif, Terputus saat Wi-Fi aktif tetapi radio tidak tersambung ke jaringan.

Pengumuman Suara untuk hasil kueri status Wi-Fi dapat dikustomisasi lewat CPS sesuai dengan kebutuhan pengguna. Tanyakan kepada penyalur atau administrator sistem Anda untuk informasi lebih lanjut.









PEMBERITAHUAN:

Tombol terprogram **Kueri Status Wi-Fi** dialokasikan oleh penyalur atau administrator sistem Anda. Tanyakan kepada dealer atau administrator sistem Anda untuk mengetahui bagaimana radio Anda diprogram.

Menyegarkan Daftar Jaringan



Ikuti prosedur berikut untuk menyegarkan daftar jaringan.

- Lakukan tindakan berikut ini untuk menyegarkan daftar jaringan melalui menu.
 - a. Tekan  untuk mengakses menu.
 - b. Tekan  atau  ke WiFi dan tekan  untuk memilih.

- c. Tekan  atau  ke Jaringan dan tekan  untuk memilih.

Ketika Anda masuk ke menu Jaringan, radio menyegarkan daftar jaringan secara otomatis.

- Jika Anda sudah berada di menu Jaringan, lakukan tindakan berikut ini untuk menyegarkan daftar jaringan.

Tekan  atau  ke Segarkan dan tekan  untuk memilih.

Radio akan menyegarkan dan menampilkan daftar jaringan terbaru.

Menambahkan Jaringan



PEMBERITAHUAN:

Tugas ini tidak bisa diterapkan ke jaringan Wi-Fi WPA-Enterprise.

Jika jaringan yang dipilih tidak terdapat dalam daftar jaringan tersedia, lakukan tindakan berikut ini untuk menambahkan jaringan.

- 1 Tekan  untuk mengakses menu.

- 2 Tekan  atau  ke WiFi dan tekan  untuk memilih.

- 3 Tekan  atau  ke Jaringan dan tekan  untuk memilih.

- 4 Tekan  atau  ke Tambah Jaringan dan tekan  untuk memilih.











- 5 Masukkan Service Set Identifier (SSID) dan tekan  .

- 6 Tekan  atau  ke Buka dan tekan  untuk memilih.

- Masukkan kata sandi dan tekan  .
Radio menampilkan pemberitahuan mini positif untuk menunjukkan bahwa jaringan berhasil disimpan.
-

Melihat Detail Titik Akses Jaringan

Anda bisa melihat detail titik akses jaringan.

- Tekan  untuk mengakses menu.
 - Tekan  atau  ke WiFi dan tekan  untuk memilih.
 - Tekan  atau  ke Jaringan dan tekan  untuk memilih.
 - Tekan  atau  ke titik akses jaringan dan tekan  untuk memilih.
-

- Tekan  atau  ke Lihat Detail dan tekan  untuk memilih.



PEMBERITAHUAN:

Wi-Fi WPA-Personal dan WPA-Enterprise menampilkan detail yang berbeda atas Titik Akses Jaringan.

Wi-Fi WPA-Personal

Untuk titik akses jaringan yang terhubung, radio Anda menampilkan Service Set Identifier (SSID), Security Mode, alamat Media Access Control (MAC), dan alamat Internet Protocol (IP).

Untuk titik akses jaringan yang tidak terhubung, radio Anda menampilkan SSID dan Security Mode.

Wi-Fi WPA-Enterprise

Untuk titik akses jaringan yang terhubung, radio Anda menampilkan SSID, Security Mode, Identity, Extended Authentication Protocol (EAP) Method, Phase 2 Authentication, Cert Name, alamat MAC, alamat IP, Gateway, DNS1, dan DNS2.

Untuk titik akses jaringan yang tidak terhubung, radio Anda menampilkan SSID, Security Mode, Identity, EAP Method, Phase 2 Authentication, dan Cert Name.

Menghapus Titik Akses Jaringan



PEMBERITAHUAN:

Tugas ini tidak bisa diterapkan ke jaringan Wi-Fi Enterprise.

Lakukan tindakan berikut ini untuk menghapus titik akses jaringan dari daftar profil.

- 1 Tekan  untuk mengakses menu.

- 2 Tekan  atau  ke WiFi dan tekan  untuk memilih.

- 3 Tekan  atau  ke Jaringan dan tekan  untuk memilih.

- 4 Tekan  atau  ke titik akses jaringan yang dipilih dan tekan  untuk memilih.

- 5 Tekan  atau  ke Hapus dan tekan  untuk memilih.

- 6 Tekan  atau  ke Ya dan tekan  untuk memilih.

Radio menampilkan pemberitahuan mini positif untuk menunjukkan bahwa titik akses jaringan yang dipilih berhasil dihapus.

Utilitas

Bab ini menjelaskan pengoperasian fungsi utilitas yang terdapat di radio Anda.

Tingkat Redaman

Anda bisa menyesuaikan tingkat redaman untuk menyaring panggilan yang tidak diinginkan dengan kekuatan sinyal rendah atau saluran dengan derau latar belakang lebih tinggi dari normal.

Normal

Ini adalah pengaturan default.

Ketat

Pengaturan ini menyaring panggilan dan/atau derau latar belakang yang tidak diinginkan. Panggilan dari lokasi jauh mungkin juga ikut tersaring.













PEMBERITAHUAN:









Fitur ini tidak tersedia dalam saluran Citizens Band yang berada dalam frekuensi yang sama.

Mengatur Tingkat Redaman

Ikuti prosedur untuk mengatur tingkat redaman di radio Anda.

- 1 Lakukan salah satu langkah berikut:
 - Tekan tombol **Redaman Gangguan** terprogram. Lompati langkah-langkah berikut ini.
 - Tekan  untuk mengakses menu.
- 2 Tekan  atau  ke **Utilitas**. Tekan  untuk memilih.
- 3 Tekan  atau  ke **Pengaturan Radio**. Tekan  untuk memilih.
- 4 Tekan  atau  ke **Redaman**. Tekan  untuk memilih.

5 Lakukan salah satu langkah berikut:

- Tekan  atau  ke **Normal**. Tekan  untuk memilih. Layar menampilkan  di sebelah **Normal**.
- Tekan  atau  ke **Ketat**. Tekan  untuk memilih. Layar menampilkan  di sebelah **Ketat**.

Layar kembali ke menu sebelumnya secara otomatis.

Tingkat Daya

Anda dapat mengatur setelan daya ke tinggi atau rendah untuk setiap saluran.

Tinggi

Setelan tinggi memungkinkan komunikasi dengan pengguna radio yang berada dalam jarak cukup jauh dari Anda.

Rendah

Setelan rendah memungkinkan komunikasi dengan radio yang terletak dalam jarak dekat.



**PEMBERITAHUAN:**



Fitur ini tidak tersedia dalam saluran Citizens Band yang berada dalam frekuensi yang sama.



Mengatur Tingkat Daya

Ikuti prosedur untuk mengatur tingkat daya di radio Anda.









- 1 Lakukan salah satu langkah berikut:
 - Tekan tombol terprogram **Tingkat Daya**. Lompati langkah-langkah di bawah ini.
 - Tekan  untuk mengakses menu.

- 2 Tekan  atau  ke **Utilitas**. Tekan  untuk memilih.

- 3 Tekan  atau  ke **Pengaturan Radio**. Tekan  untuk memilih.

- 4 Tekan  atau  ke **Daya**. Tekan  untuk memilih.

5 Lakukan salah satu langkah berikut:

- Tekan  atau  ke **Tinggi**. Tekan  untuk memilih.
Layar menampilkan  di sebelah **Tinggi**.
- Tekan  atau  ke **Rendah**. Tekan  untuk memilih.
Layar menampilkan  di sebelah **Rendah**.

6 Tekan lama  untuk kembali ke layar Awal.



Mengaktifkan atau Menonaktifkan Nada/Peringatan Radio

Anda dapat mengaktifkan dan menonaktifkan semua nada dan peringatan radio, jika diperlukan, kecuali untuk nada peringatan Darurat yang masuk. Ikuti prosedur untuk mengaktifkan atau menonaktifkan nada dan peringatan di radio Anda.

- 1 Lakukan salah satu langkah berikut:
 - Tekan tombol **Nada/Peringatan** yang terprogram. Lompati langkah-langkah berikut ini.

- Tekan  untuk mengakses menu.



2 Tekan  atau  ke Utilitas. Tekan  untuk memilih.

3 Tekan  atau  ke Pengaturan Radio. Tekan  untuk memilih.

4 Tekan  atau  ke Nada/Peringatan. Tekan  untuk memilih.

5 Tekan  atau  ke Semua Nada. Tekan  untuk memilih.

6 Tekan  untuk mengaktifkan atau menonaktifkan semua nada dan peringatan. Layar menampilkan salah satu hasil berikut ini:



- Jika diaktifkan,  muncul di sebelah Diaktifkan.
- Jika dinonaktifkan,  hilang dari sebelah Diaktifkan.

Mengaktifkan atau Menonaktifkan Nada Keypad



Ikuti prosedur untuk mengaktifkan atau menonaktifkan nada keypad di radio Anda.



1 Tekan  untuk mengakses menu.

2 Tekan  atau  ke Utilitas. Tekan  untuk memilih.

3 Tekan  atau  ke Pengaturan Radio. Tekan  untuk memilih.





4 Tekan  atau  ke Nada/Peringatan. Tekan  untuk memilih.

5 Tekan  atau  ke Nada Keypad. Tekan  untuk memilih.

- 6 Tekan  untuk mengaktifkan atau menonaktifkan nada keypad. Layar menampilkan salah satu hasil berikut ini:
- Jika diaktifkan,  muncul di sebelah Diaktifkan.
 - Jika dinonaktifkan,  hilang dari sebelah Diaktifkan.
-

Mengatur Tingkat Offset Volume Nada/Peringatan



Fitur ini menyesuaikan volume nada atau peringatan agar dapat lebih tinggi atau lebih rendah dibandingkan volume suara. Ikuti prosedur untuk mengatur tingkat offset volume nada dan peringatan di radio Anda.



- 1 Tekan  untuk mengakses menu.
-
- 2 Tekan  atau  ke Utilitas. Tekan  untuk memilih.
-

- 3 Tekan  atau  ke Pengaturan Radio. Tekan  untuk memilih.
-

- 4 Tekan  atau  ke Nada/Peringatan. Tekan  untuk memilih.
-

- 5 Tekan  atau  ke Offset Vol.. Tekan  untuk memilih.
-



- 6 Tekan  atau  ke tingkat offset volume yang diinginkan. Nada umpan balik akan berbunyi bersama setiap tingkat offset volume yang berhubungan.
-



- 7 Lakukan salah satu langkah berikut:
- Tekan  untuk memilih. Level offset volume yang diperlukan telah disimpan.
 - Tekan  untuk keluar. Perubahan dibuang.
-



Mengaktifkan atau Menonaktifkan Nada Izin Bicara



Ikuti prosedur untuk mengaktifkan atau menonaktifkan Nada Izin Bicara di radio Anda.

- 1 Tekan  untuk mengakses menu.

- 2 Tekan  atau  ke Utilitas. Tekan  untuk memilih.



- 3 Tekan  atau  ke Pengaturan Radio. Tekan  untuk memilih.

- 4 Tekan  atau  ke Nada/Peringatan. Tekan  untuk memilih.

- 5 Tekan  atau  ke Izin Bicara. Tekan  untuk memilih.

- 6 Tekan  untuk mengaktifkan atau menonaktifkan Nada Izin Bicara.



Layar menampilkan salah satu hasil berikut ini:



- Jika diaktifkan,  muncul di sebelah Diaktifkan.
- Jika dinonaktifkan,  hilang dari sebelah Diaktifkan.

Mengaktifkan atau Menonaktifkan Nada Penyalan

Ikuti prosedur untuk mengaktifkan atau menonaktifkan Nada Penyalan di radio Anda.

- 1 Tekan  untuk mengakses menu.

- 2 Tekan  atau  ke Utilitas. Tekan  untuk memilih.

- 3 Tekan  atau  ke Pengaturan Radio. Tekan  untuk memilih.

4 Tekan  atau  ke Nada/Peringatan.

Tekan  untuk memilih.

5 Tekan  atau  ke Penyalaan. Tekan  untuk memilih.

6 Tekan  untuk mengaktifkan atau menonaktifkan Nada Penyalaan. Layar menampilkan salah satu hasil berikut ini:

- Jika diaktifkan, ✓ muncul di sebelah Diaktifkan.
 - Jika dinonaktifkan, ✓ hilang dari sebelah Diaktifkan.
-

Mengatur Nada Peringatan Pesan Teks

Anda dapat mengatur nada peringatan pesan teks ke Sesaat atau Berulang untuk tiap entri dalam daftar Kontak. Ikuti prosedur untuk mengatur nada peringatan pesan teks di radio Anda.





1 Tekan  untuk mengakses menu.

2 Tekan  atau  ke Kontak. Tekan  untuk memilih.

3 Tekan  atau  ke alias atau ID yang diinginkan. Tekan  untuk memilih.

4 Tekan  atau  ke Peringatan Pesan. Tekan  untuk memilih.

5 Lakukan salah satu langkah berikut:

- Tekan  atau  ke Sementara. Tekan  untuk memilih. Layar menampilkan ✓ di sebelah Sementara.
 - Tekan  atau  ke Berulang. Tekan  untuk memilih. Layar menampilkan ✓ di sebelah Berulang.
-



Mengubah Mode Layar





Anda dapat mengubah mode layar radio antara Siang atau Malam, sesuai kebutuhan. Fitur ini memengaruhi palet warna pada layar. Ikuti prosedur untuk mengubah mode layar radio.

- 1 Lakukan salah satu langkah berikut:
 - Tekan tombol **Mode Tampilan** terprogram. Lompati langkah-langkah berikut ini.
 - Tekan  untuk mengakses menu.

- 2 Tekan  atau  ke Utilitas. Tekan  untuk memilih.

- 3 Tekan  atau  ke Pengaturan Radio. Tekan  untuk memilih.

- 4 Tekan  atau  ke Tampilan. Tekan  untuk memilih.
Layar menampilkan Mode Siang dan Mode Malam.

- 5 Tekan  atau  ke pengaturan yang diinginkan. Tekan  untuk memilih.
Layar menampilkan  di sebelah pengaturan yang dipilih.

Mengatur Kecerahan Layar

Ikuti prosedur untuk mengatur kecerahan layar di radio Anda. Kecerahan layar tidak dapat disesuaikan bila Kecerahan Otomatis diaktifkan.

- 1 Lakukan salah satu langkah berikut:
 - Tekan tombol **Kecerahan** terprogram. Lompati langkah-langkah berikut ini.
 - Tekan  untuk mengakses menu.



- 2 Tekan  atau  ke Utilitas. Tekan  untuk memilih.

3 Tekan  atau  ke Pengaturan Radio.

Tekan  untuk memilih.

4 Tekan  atau  ke Kecerahan. Tekan  untuk memilih.

Layar menampilkan bilah kemajuan.

5 Tekan  atau  untuk mengurangi atau menambah kecerahan layar. Tekan  untuk memilih.

Nilai pengaturan bervariasi, mulai dari 1 sampai 8.

Mengaktifkan atau Menonaktifkan Klakson/Lampu

Radio dapat memberi tahu Anda bila ada panggilan masuk melalui fitur klakson dan lampu. Jika diaktifkan, panggilan masuk akan membunyikan klakson dan menyalakan lampu kendaraan. Fitur ini harus dipasang melalui konektor aksesoris belakang pada radio oleh dealer. Ikuti prosedur



untuk mengaktifkan atau menonaktifkan klakson dan lampu pada radio Anda.

1 Lakukan salah satu langkah berikut:

- Tekan tombol **Klakson/Lampu** yang telah diprogram. Lompati langkah-langkah di bawah ini.
 - Tekan  untuk mengakses menu.
-

2 Tekan  atau  ke Utilitas. Tekan  untuk memilih.

3 Tekan  atau  ke Pengaturan Radio. Tekan  untuk memilih.

4 Tekan  atau  ke Klakson/Lampu. Tekan  untuk memilih.



5 Tekan  untuk mengaktifkan atau menonaktifkan Klakson/Lampu. Layar menampilkan salah satu hasil berikut ini:



- Jika diaktifkan, ✓ muncul di sebelah Diaktifkan.
 - Jika dinonaktifkan, ✓ hilang dari sebelah Diaktifkan.
-



Mengaktifkan atau Menonaktifkan Indikator LED

Ikuti prosedur untuk mengaktifkan atau menonaktifkan indikator LED di radio Anda.

- 1 Tekan  untuk mengakses menu.

 - 2 Tekan  atau  ke *Utilitas*. Tekan  untuk memilih.

 - 3 Tekan  atau  ke *Pengaturan Radio*. Tekan  untuk memilih.

 - 4 Tekan  atau  ke *Indikator LED*. Tekan  untuk memilih.
-

- 5 Tekan  untuk mengaktifkan atau menonaktifkan Indikator LED.



Layar menampilkan salah satu hasil berikut ini:

- Jika diaktifkan, ✓ muncul di sebelah Diaktifkan.
 - Jika dinonaktifkan, ✓ hilang dari sebelah Diaktifkan.
-

Mengaktifkan atau Menonaktifkan Sistem Public Address

Ikuti prosedur untuk mengaktifkan atau menonaktifkan sistem public address (PA) internal radio Anda.

- 1 Lakukan salah satu langkah berikut:
 - Tekan tombol **Public Address** yang diprogram. Lompati langkah-langkah berikut ini.
 - Tekan  untuk mengakses menu.

 - 2 Tekan  atau  ke *Utilitas*. Tekan  untuk memilih.
-

3 Tekan  atau  ke Pengaturan Radio.

Tekan  untuk memilih.

4 Tekan  atau  ke Public Address. Tekan

 untuk memilih.

5 Tekan  untuk mengaktifkan atau menonaktifkan Public Address.

- Jika diaktifkan, ✓ muncul di sebelah Diaktifkan.
 - Jika dinonaktifkan, ✓ hilang dari sebelah Diaktifkan.
-

Mengaktifkan atau Menonaktifkan Sistem Public Address Eksternal

Ikuti prosedur untuk mengaktifkan atau menonaktifkan sistem public address (PA) eksternal radio Anda.

1 Lakukan salah satu langkah berikut:

- Tekan tombol **Public Address Ekst** yang diprogram. Lompati langkah-langkah berikut ini.

- Tekan  untuk mengakses menu.
-

2 Tekan  atau  ke Utilitas. Tekan  untuk memilih.

3 Tekan  atau  ke Pengaturan Radio. Tekan  untuk memilih.

4 Tekan  atau  ke Public Address Eksternal. Tekan  untuk memilih.

5 Tekan  untuk mengaktifkan atau menonaktifkan public address eksternal.

- Jika diaktifkan, ✓ muncul di sebelah Diaktifkan.
 - Jika dinonaktifkan, ✓ hilang dari sebelah Diaktifkan.
-

Mengaktifkan atau Menonaktifkan Layar Pengantar

Anda bisa mengaktifkan dan menonaktifkan Layar Pengantar dengan mengikuti prosedur ini.

- 1 Tekan  untuk mengakses menu.

- 2 Tekan  atau  ke Utilitas. Tekan  untuk memilih.

- 3 Tekan  atau  ke Pengaturan Radio. Tekan  untuk memilih.

- 4 Tekan  atau  ke Tampilan. Tekan  untuk memilih.

- 5 Tekan  atau  ke Layar Pengantar. Tekan  untuk memilih.

- 6 Tekan  untuk mengaktifkan atau menonaktifkan Layar Pengantar.



Layar menampilkan salah satu hasil berikut ini:



- Jika diaktifkan, ✓ muncul di sebelah Diaktifkan.
- Jika dinonaktifkan, ✓ hilang dari sebelah Diaktifkan.

Mengatur Bahasa





Ikuti prosedur untuk mengatur bahasa di radio Anda.

- 1 Tekan  untuk mengakses menu.

- 2 Tekan  atau  ke Utilitas. Tekan  untuk memilih.

- 3 Tekan  atau  ke Pengaturan Radio. Tekan  untuk memilih.

4 Tekan  atau  ke Bahasa. Tekan  untuk memilih.

5 Tekan  atau  ke bahasa yang diinginkan. Tekan  untuk memilih. Layar menampilkan  di sebelah bahasa yang dipilih.



Mengidentifikasi Jenis Kabel

Lakukan langkah berikut untuk memilih jenis kabel yang digunakan pada radio Anda.

1 Tekan  untuk mengakses menu.

2 Tekan  atau  ke Utilitas. Tekan  untuk memilih.

3 Tekan  atau  ke Pengaturan Radio. Tekan  untuk memilih.

4 Tekan  atau  ke Jenis Kabel. Tekan  untuk memilih.

5 Jenis kabel saat ini akan ditandai dengan .

Transmisi Pengoperasian Suara

Transmisi Pengoperasian Suara (VOX) memungkinkan Anda memulai panggilan yang diaktifkan suara tanpa perlu memegang perangkat di saluran terprogram. Radio secara otomatis mengirim transmisi, untuk periode terprogram, apabila mikrofon pada aksesori yang berkemampuan VOX mendeteksi suara.



PEMBERITAHUAN:

Fitur ini tidak tersedia dalam saluran Citizens Band yang berada dalam frekuensi yang sama.

Anda dapat mengaktifkan atau menonaktifkan VOX dengan melakukan salah satu dari hal-hal berikut ini:

- Matikan radio, lalu nyalakan kembali untuk mengaktifkan VOX.
- Ganti saluran menggunakan tombol **Gulir Naik/Turun** untuk mengaktifkan VOX.

- Ganti saluran menggunakan **Kenop Volume/Saluran** untuk mengaktifkan VOX.
- Aktifkan atau nonaktifkan VOX melalui tombol **VOX** yang diprogram atau menu untuk mengaktifkan VOX.
- Tekan tombol **PTT** selama pengoperasian radio untuk menonaktifkan VOX.



PEMBERITAHUAN:



Menghidupkan atau mematikan fitur ini terbatas pada radio yang menghidupkan fitur ini. Tanyakan kepada penyalur atau administrator sistem Anda untuk informasi lebih lanjut.

Mengaktifkan atau Menonaktifkan Transmisi Pengoperasian Suara

Ikuti prosedur untuk mengaktifkan atau menonaktifkan VOX di radio Anda.

- 1 Lakukan salah satu langkah berikut:
 - Tekan tombol terprogram **VOX**. Lompati langkah-langkah di bawah ini.
 - Tekan  untuk mengakses menu.

- 2 Tekan  atau  ke *Utilitas*. Tekan  untuk memilih.

- 3 Tekan  atau  ke *Pengaturan Radio*. Tekan  untuk memilih.

- 4 Tekan  atau  ke *VOX*. Tekan  untuk memilih.

- 5 Tekan  untuk mengaktifkan atau menonaktifkan **VOX**.



PEMBERITAHUAN:

Jika fitur Nada Izin Bicara diaktifkan, gunakan kata pemicu untuk memulai panggilan. Tunggu Nada Izin Bicara selesai sebelum berbicara dengan jelas di mikrofon. Lihat [Mengaktifkan atau Menonaktifkan Nada Izin Bicara di halaman 210](#) untuk informasi selengkapnya.

Mengaktifkan atau Menonaktifkan Pengumuman Suara

Fitur ini mengaktifkan radio agar memberikan indikasi audio tentang zona atau saluran saat ini yang ditetapkan oleh pengguna, atau tombol yang dapat diprogram yang ditekan oleh pengguna.

Ini biasanya berguna ketika pengguna kesulitan untuk membaca konten yang ditampilkan di layar.

Indikator audio dapat diatur sesuai kebutuhan pelanggan. Ikuti prosedur untuk mengaktifkan atau menonaktifkan Pengumuman Suara di radio Anda.

Mengaktifkan atau Menonaktifkan Papan Opsi

Kemampuan papan opsi dalam setiap saluran dapat dialokasikan ke tombol yang dapat diprogram. Sebuah saluran dapat mendukung hingga 6 fitur papan opsi. Ikuti prosedur untuk mengaktifkan atau menonaktifkan papan opsi di radio Anda.

Tekan tombol **Papan Opsi** yang terprogram.

Teks ke Ucapan

Fitur Teks ke Ucapan hanya dapat diaktifkan oleh dealer atau administrator sistem Anda. Jika Teks ke Ucapan diaktifkan, fitur Pengumuman Suara dinonaktifkan secara otomatis. Jika Pengumuman Suara diaktifkan, fitur Teks ke Ucapan dinonaktifkan secara otomatis.

Fitur ini membuat radio dapat mengindikasikan fitur-fitur berikut ini melalui suara:



- Saluran Saat Ini
- Zona Saat Ini
- Fitur tombol terprogram aktif atau nonaktif
- Konten dari pesan teks yang diterima
- Konten dari Tiket Tugas yang diterima



Indikator audio dapat dikustomisasi menurut keperluan subscriber. Fitur ini biasanya berguna ketika pengguna kesulitan untuk membaca informasi yang ditampilkan di layar.



Mengatur Teks ke Ucapan



Ikuti prosedur untuk mengatur fitur Teks ke Ucapan.

- 1 Tekan  untuk mengakses menu.

- 2 Tekan  atau  ke Utilitas. Tekan  untuk memilih.

- 3 Tekan  atau  ke Pengaturan Radio. Tekan  untuk memilih.

- 4 Tekan  atau  ke Pengumuman Suara. Tekan  untuk memilih.

- 5 Tekan  atau  ke salah satu fitur berikut. Tekan  untuk memilih.
Fitur yang tersedia adalah sebagai berikut:
 - Semua
 - Pesan
 - Tiket Tugas
 - Saluran
 - Zona



- Tombol Program



✓ muncul di sebelah pengaturan yang dipilih.



Mengaktifkan atau Menonaktifkan Penerusan Panggilan Otomatis

Anda dapat mengaktifkan radio Anda agar secara otomatis meneruskan panggilan suara ke radio lain.





- 1 Tekan  untuk mengakses menu.

- 2 Tekan  atau  ke Utilitas. Tekan  untuk memilih.

- 3 Tekan  atau  ke Pengaturan Radio. Tekan  untuk memilih.







- 4 Tekan  atau  ke Penerusan Panggilan. Tekan  untuk memilih.

5 Lakukan salah satu langkah berikut:

- Tekan  atau  untuk mengaktifkan Penerusan Panggilan. Jika diaktifkan, ✓ muncul di sebelah Diaktifkan.
- Tekan  atau  untuk menonaktifkan Penerusan Panggilan. Jika dinonaktifkan, ✓ hilang dari sebelah Diaktifkan.



Mengatur Pencatat Waktu Menu

Anda dapat mengatur lama waktu radio Anda berada di menu sebelum otomatis beralih ke layar Awal. Ikuti prosedur untuk mengatur pencatat waktu menu.

- 1 Tekan  untuk mengakses menu.
- 2 Tekan  atau  ke Utilitas. Tekan  untuk memilih.
- 3 Tekan  atau  ke Pengaturan Radio. Tekan  untuk memilih.

- 4 Tekan  atau  ke Tampilan. Tekan  untuk memilih.

- 5 Tekan  atau  ke Pencatat Waktu Menu. Tekan  untuk memilih.

- 6 Tekan  atau  ke pengaturan yang diinginkan. Tekan  untuk memilih.



Mengaktifkan atau Menonaktifkan AGC Mikrofon Analog



Automatic Gain Control (AGC) Mikrofon Analog mengontrol gain mikrofon pada radio secara otomatis ketika melakukan transmisi pada sistem analog.



Fitur ini menekan audio yang keras atau mempertegas audio yang halus ke nilai yang telah ditetapkan untuk menghasilkan tingkat audio yang konsisten. Ikuti prosedur



untuk mengaktifkan atau menonaktifkan AGC Mikrofon Analog di radio Anda.

- 1 Tekan  untuk mengakses menu.

- 2 Tekan  atau  ke Utilitas. Tekan  untuk memilih.

- 3 Tekan  atau  ke Pengaturan Radio. Tekan  untuk memilih.

- 4 Tekan  atau  ke Mic AGC-A. Tekan  untuk memilih.



- 5 Tekan  untuk mengaktifkan atau menonaktifkan AGC Mikrofon Analog.
Layar menampilkan salah satu hasil berikut ini:
 - Jika diaktifkan,  muncul di sebelah Diaktifkan.
 - Jika dinonaktifkan,  hilang dari sebelah Diaktifkan.



Mengaktifkan atau Menonaktifkan AGC Mikrofon Digital



Automatic Gain Control (AGC) Mikrofon Digital mengontrol gain mikrofon pada radio secara otomatis ketika melakukan transmisi pada sistem digital.

Fitur ini menekan audio yang keras atau mempertegas audio yang halus ke nilai yang telah ditetapkan untuk menghasilkan tingkat audio yang konsisten. Ikuti prosedur untuk mengaktifkan atau menonaktifkan AGC Mikrofon Digital di radio Anda.

- 1 Tekan  untuk mengakses menu.

- 2 Tekan  atau  ke Utilitas. Tekan  untuk memilih.

- 3 Tekan  atau  ke Pengaturan Radio. Tekan  untuk memilih.

- 4 Tekan  atau  ke Mic AGC-D. Tekan  untuk memilih.

- 5 Tekan  untuk mengaktifkan atau menonaktifkan AGC Mikrofon Digital.

Layar menampilkan salah satu hasil berikut ini:

- Jika diaktifkan, ✓ muncul di sebelah Diaktifkan.
- Jika dinonaktifkan, ✓ hilang dari sebelah Diaktifkan.

Mengaktifkan atau Menonaktifkan Audio Cerdas

Radio akan menyesuaikan volume audio secara otomatis untuk mengatasi derau latar belakang yang ada di lingkungan, termasuk sumber derau stasioner maupun non-stasioner. Ini adalah fitur hanya-terima dan tidak memengaruhi audio transmisi. Ikuti prosedur untuk mengaktifkan atau menonaktifkan Audio Cerdas di radio Anda.



PEMBERITAHUAN:



Fitur ini tidak tersedia saat sesi Bluetooth berlangsung.

- 1 Lakukan salah satu langkah berikut:



- Tekan tombol **Audio Cerdas** yang telah diprogram. Lompati langkah-langkah di bawah ini.
- Tekan  untuk mengakses menu.





- 2 Tekan  atau  ke Utilitas. Tekan  untuk memilih.

- 3 Tekan  atau  ke Pengaturan Radio. Tekan  untuk memilih.

- 4 Tekan  atau  ke Audio Cerdas. Tekan  untuk memilih.

- 5 Lakukan salah satu langkah berikut:



- Tekan  atau  ke Aktif. Tekan  untuk memilih. Layar menampilkan ✓ di sebelah Aktif.



- Tekan  atau  ke Nonaktif. Tekan  untuk memilih. Layar menampilkan  di sebelah Nonaktif.
-

Mengaktifkan atau Menonaktifkan Fitur Peredam Umpan Balik Akustik





Dengan fitur ini Anda dapat meminimalkan Peredam Umpan Balik Akustik di panggilan yang diterima. Ikuti prosedur untuk mengaktifkan atau menonaktifkan Peredam Umpan Balik Akustik pada radio Anda.

- 1 Tekan  untuk mengakses menu.

 - 2 Tekan  atau  ke Utilitas. Tekan  untuk memilih..

 - 3 Tekan  atau  ke Pengaturan Radio. Tekan  untuk memilih.
-

- 4 Tekan  atau  ke Peredam AF. Tekan  untuk memilih.
-

- 5 Lakukan salah satu langkah berikut:
 - Tekan  untuk mengaktifkan Peredam Umpan Balik Akustik. Jika diaktifkan,  muncul di sebelah Diaktifkan.
 - Tekan  untuk menonaktifkan Peredam Umpan Balik Akustik. Jika dinonaktifkan,  hilang dari sebelah Diaktifkan.
-

Mengaktifkan atau Menonaktifkan Peningkatan Trill

Anda dapat mengaktifkan fitur ini jika berbicara dalam bahasa yang memiliki banyak kata dengan bunyi getar ("R"). Ikuti prosedur untuk mengaktifkan atau menonaktifkan Peningkatan Trill di radio Anda.

- 1 Lakukan salah satu langkah berikut:
 - Tekan tombol **Peningkatan Trill** terprogram. Lompati langkah-langkah di bawah ini.









- Tekan  untuk mengakses menu.

- 2 Tekan  atau  ke Utilitas. Tekan  untuk memilih.

- 3 Tekan  atau  ke Pengaturan Radio. Tekan  untuk memilih.

- 4 Tekan  atau  ke Peningkatan Trill. Tekan  untuk memilih.

- 5 Lakukan salah satu langkah berikut:

- Tekan  atau  ke Aktif. Tekan  untuk memilih. Layar menampilkan  di sebelah Aktif.
- Tekan  atau  ke Nonaktif. Tekan  untuk memilih. Layar menampilkan  di sebelah Nonaktif.

Ambien Audio

Anda dapat mengatur ambien audio sesuai dengan keadaan di sekitar.

Default

Ini adalah pengaturan default.

Keras

Pengaturan ini mengaktifkan Peredam Derau dan meningkatkan kekerasan speaker untuk penggunaan di lingkungan yang bising.

Grup Kerja

Pengaturan ini mengaktifkan Peredam AF dan menonaktifkan AGC ketika digunakan di dekat beberapa radio lain.

Mengatur Ambien Audio

Ikuti prosedur untuk mengatur ambien audio di radio Anda sesuai dengan lingkungan.

- 1 Tekan  untuk mengakses menu.



- 2 Tekan  atau  ke Utilitas. Tekan  untuk memilih.

3 Tekan  atau  ke Pengaturan Radio.

Tekan  untuk memilih.

4 Tekan  atau  ke Ambien Audio. Tekan

 untuk memilih.

5 Tekan  atau  ke pengaturan yang diinginkan. Tekan  untuk memilih.

Pengaturannya adalah sebagai berikut.

- Pilih **Default** untuk pengaturan pabrik default.
- Pilih **Keras** untuk meningkatkan kekerasan volume speaker saat digunakan di lingkungan sekitar yang bising.
- Pilih **Grup Kerja** untuk mengurangi umpan balik akustik saat digunakan dengan sekelompok radio yang saling berdekatan.

Layar menampilkan  di sebelah pengaturan yang dipilih.

Profil Audio

Anda dapat mengatur profil audio untuk radio sesuai dengan preferensi Anda.

Default

Ini adalah pengaturan default.

Tingkat 1, Tingkat 2, dan Tingkat 3

Pengaturan ini dimaksudkan sebagai kompensasi atas hilangnya pendengaran akibat derau yang lazim pada usia 40-an, 50-an, dan 60-an atau lebih.

Treble Boost, Mid Boost, dan Bass Boost

Pengaturan ini dimaksudkan untuk menghasilkan suara lebih kecil, suara lebih sengau, dan suara lebih dalam.

Mengatur Profil Audio

Ikuti prosedur untuk menentukan profil audio default di radio Anda.

1 Tekan  untuk mengakses menu.



2 Tekan  atau  ke **Utilitas**. Tekan  untuk memilih.

3 Tekan  atau  ke Pengaturan Radio.

Tekan  untuk memilih.

4 Tekan  atau  ke Profil Audio. Tekan

 untuk memilih.

5 Tekan  atau  ke pengaturan yang diinginkan. Tekan  untuk memilih.

Pengaturannya adalah sebagai berikut.

- Pilih **Default** untuk menonaktifkan profil audio yang dipilih sebelumnya dan kembali ke pengaturan pabrik default.
- Pilih **Level 1**, **Level 2**, atau **Level 3** untuk profil audio yang ditujukan untuk mengompensasi berkurangnya daya dengar akibat kebisingan yang lazim ditemui pada orang dewasa berusia di atas 40 tahun.
- Pilih **Treble Boost**, **Mid Boost**, atau **Bass Boost** untuk profil audio yang selaras dengan

preferensi Anda untuk suara yang lebih tipis, sengau, atau dalam.

Layar menampilkan  di sebelah pengaturan yang dipilih.

Mengaktifkan atau Menonaktifkan Global Navigation Satellite System

Global Navigation Satellite System (GNSS) adalah sistem navigasi satelit yang menentukan lokasi radio dengan tepat. GNSS mencakup Global Positioning System (GPS) dan BeiDou Navigation Satellite System (BDS).



PEMBERITAHUAN:

Model radio tertentu mungkin menawarkan GPS dan BDS. Konstelasi GNSS dikonfigurasi menggunakan CPS. Tanyakan kepada dealer atau administrator sistem Anda untuk mengetahui bagaimana radio Anda diprogram.

- 1 Lakukan salah satu langkah berikut untuk mengaktifkan atau menonaktifkan GNSS di radio Anda.
 - Tekan tombol terprogram **GNSS**.

- Tekan  untuk mengakses menu. Lanjutkan ke langkah berikutnya.
-

2 Tekan  atau  ke Utilitas. Tekan  untuk memilih.

3 Tekan  atau  ke Pengaturan Radio. Tekan  untuk memilih.

4 Tekan  atau  ke GNSS. Tekan  untuk memilih.

5 Tekan  untuk mengaktifkan atau menonaktifkan GNSS.

Jika diaktifkan, ✓ muncul di sebelah Diaktifkan.
Jika dinonaktifkan, ✓ hilang dari sebelah Diaktifkan.



Daftar Terima Fleksibel

Daftar Terima Fleksibel adalah fitur yang memungkinkan Anda membuat dan mengalokasikan anggota pada daftar terima grup bicara. Radio Anda bisa mendukung maksimal 16 anggota di daftar tersebut. Fitur ini tidak didukung dalam Capacity Plus.







Mengaktifkan atau Menonaktifkan Daftar Terima Fleksibel

Ikuti prosedur untuk mengaktifkan atau menonaktifkan Daftar Terima Fleksibel.

- 1 Lakukan salah satu langkah berikut:
 - Tekan tombol **Daftar Terima Fleksibel** terprogram. Lompati langkah-langkah berikut ini.
 - Tekan  untuk mengakses menu.
-

2 Tekan  atau  ke Daftar Rx Fleksibel. Tekan  untuk memilih.

3 Lakukan salah satu langkah berikut:

- Tekan  atau  ke Aktifkan. Tekan  untuk memilih. Nada indikator positif akan berbunyi. Layar menampilkan pemberitahuan mini positif.
- Tekan  atau  ke Nonaktifkan. Tekan  untuk memilih. Nada indikator negatif akan berbunyi. Layar menampilkan pemberitahuan mini negatif.

Informasi Umum Radio

Radio Anda memuat informasi tentang berbagai parameter umum.

Informasi umum radio Anda adalah sebagai berikut:

- Alias dan ID radio.
- Versi Firmware dan Codeplug.
- Pembaruan perangkat lunak.
- Informasi GNSS.
- Informasi site.







PEMBERITAHUAN:

Tekan  untuk kembali ke layar sebelumnya.

Tekan lama  untuk kembali ke layar Awal. Radio keluar dari layar saat ini setelah pencatat waktu nonaktif berakhir.

Memeriksa Alias dan ID Radio

Ikuti prosedur untuk memeriksa alias dan ID radio pada radio Anda.

- 1 Lakukan salah satu langkah berikut:
 - Tekan tombol **Alias dan ID Radio** yang telah diprogram. Lompati langkah-langkah berikut ini. Nada indikator positif akan berbunyi. Anda juga dapat menekan tombol **Alias dan ID Radio** yang terprogram untuk kembali ke layar sebelumnya.
 - Tekan  untuk mengakses menu.
- 2 Tekan  atau  ke **Utilitas**. Tekan  untuk memilih.

3 Tekan  atau  ke Info Radio. Tekan  untuk memilih.

4 Tekan  atau  ke ID Saya. Tekan  untuk memilih.

Baris teks pertama menunjukkan alias radio. Baris teks kedua menampilkan ID radio.

Memeriksa Versi Firmware dan Codeplug

Ikuti prosedur untuk memeriksa versi firmware dan codeplug pada radio Anda.

1 Tekan  untuk mengakses menu.

2 Tekan  atau  ke Utilitas. Tekan  untuk memilih.

3 Tekan  atau  ke Info Radio. Tekan  untuk memilih.

4 Tekan  atau  ke Versi. Tekan  untuk memilih.

Layar menampilkan versi firmware dan codeplug yang sekarang.



Memeriksa Informasi Pembaruan Perangkat Lunak

Fitur ini menampilkan tanggal dan waktu pembaruan perangkat lunak terakhir yang dilakukan melalui OTAP atau Wi-Fi. Ikuti prosedur untuk memeriksa informasi pembaruan perangkat lunak pada radio Anda.

1 Tekan  untuk mengakses menu.

2 Tekan  atau  ke Utilitas. Tekan  untuk memilih.

3 Tekan  atau  ke Info Radio. Tekan  untuk memilih.

- 4 Tekan  atau  ke Pembaruan Perangkat Lunak. Tekan  untuk memilih. Layar menampilkan tanggal dan waktu pembaruan perangkat lunak terbaru.













Menu Pembaruan Perangkat Lunak hanya tersedia setelah setidaknya satu sesi OTAP atau Wi-Fi yang berhasil. Lihat [Pemrograman Melalui Udara di halaman 495](#) untuk informasi selengkapnya.

Memeriksa Informasi GNSS

Menampilkan informasi GNSS di radio, misalnya nilai:

- Garis Lintang
- Garis Bujur
- Ketinggian
- Arah
- Kecepatan
- HDOP (Penipisan Ketepatan secara Horizontal)
- Satelit

• Versi

- 1 Tekan  untuk mengakses menu.
-
- 2 Tekan  atau  ke Utilitas. Tekan  untuk memilih.
-
- 3 Tekan  atau  ke Info Radio. Tekan  untuk memilih.
-
- 4 Tekan  atau  ke Info GNSS. Tekan  untuk memilih.
-
- 5 Tekan  atau  ke item yang diperlukan. Tekan  untuk memilih. Informasi GNSS yang diminta akan ditampilkan di layar.

Menampilkan Informasi Site

Ikuti prosedur untuk menampilkan nama site tempat radio Anda berada saat ini.

- 1 Tekan  untuk mengakses menu.

- 2 Tekan  atau  ke Utilitas. Tekan  untuk memilih.

- 3 Tekan  atau  ke Info Radio. Tekan  untuk memilih.



- 4 Tekan  atau  ke Info Site. Tekan  untuk memilih.



Nama site saat ini akan ditampilkan di layar.



Melihat Detail Sertifikat Wi-Fi Enterprise

Anda bisa melihat detail Sertifikat Wi-Fi Enterprise terpilih.

- 1 Tekan  untuk mengakses menu.

- 2 Tekan  atau  ke Utilitas. Tekan  untuk memilih.

- 3 Tekan  atau  ke Menu Sertifikat. Tekan  untuk memilih.
✓ tampak di samping sertifikat yang siap.

- 4 Tekan  atau  ke sertifikat yang diinginkan. Tekan  untuk memilih.

Radio Anda menampilkan detail lengkap dari sertifikat.



PEMBERITAHUAN:

Untuk sertifikat yang belum siap, layar hanya menampilkan Status.

Daftar Aksesori Resmi

Motorola Solutions menyediakan daftar aksesori untuk meningkatkan produktivitas radio Anda.

Antena

- Kombinasi GNSS (GPS/Galileo/QZSS/GLONASS), UHF, 403–527 MHz, Penguatan 2.0 dB, Pemasangan Dengan Pin, BNC (HAE6017_)
- Kombinasi GPS/UHF, 470 – 527 MHz, Gelombang 1/4, Pemasangan dengan Pin, BNC (HAE6018_)
- UHF, 403–527 MHz, Penguatan 2,0 dB, Pemasangan dengan Pin, BNC (HAE6021_)
- Kombinasi GPS/UHF, 494 – 512 MHz, Penguatan 3,0 dB, Pemasangan dengan Pin, BNC (HAE6023_)
- Kombinasi GPS/UHF, 470 – 494 MHz, Penguatan 3,0 dB, Pemasangan dengan Pin, BNC (HAE6025_)
- 800/900, 806-941 MHz, Batang Pendek, Pemasangan dengan Pin, Mini U (HAF4013_)
- 800/900, 806-941 MHz, Gelombang 1/4, Pemasangan dengan Pin, Mini U (HAF4025_)
- 800/900, 806-941 MHz, Penguatan 3 dB, Pemasangan dengan Pin, Mini U (HAF4026_)
- 800/900, 806–941 MHz, Penguatan 5,0 dB, Pemasangan dengan Pin, Mini-U (HAF4027_)
- Kombinasi GPS+RF, 806–941 MHz, Gelombang 1/4, Pemasangan dengan Pin, Mini-U (HAF4029_)
- Kombinasi GPS+RF, 806–941 MHz, Penguatan 3,0 dB, Pemasangan dengan Pin, Mini-U (HAF4030_)
- Kombinasi GPS+RF, 806–941 MHz, Penguatan 5.0 dB, Pemasangan dengan Pin, Mini-U (HAF4032_)
- Kombinasi GPS+RF, 806–941 MHz, Penguatan 5,0 dB, Pemasangan dengan Pin, Mini-U (HAF4033_)
- UHF, 300–340 MHz, 1/4 Gelombang, Pemasangan Dengan Pin, BNC (PMAD4140_)
- Kombinasi GPS/GNSS/UHF, 350–400 MHz, Gelombang 1/4, Pemasangan dengan Pin, BNC (PMAD4102_)
- UHF, 350–400 MHz, Gelombang 1/4, Pemasangan Dengan Pin, BNC (PMAD4107_)
- UHF, 320–360 MHz, 1/4 Gelombang, Pemasangan Dengan Pin, BNC (PMAD4141_)

- Kombinasi GNSS (GPS/Galileo/QZSS/GLONASS), UHF, 300–340 MHz, 1/4 Gelombang, Pemasangan Dengan Pin, BNC (PMAD4142_)
- Kombinasi GNSS (GPS/Galileo/QZSS/GLONASS), UHF, 320–360 MHz, 1/4 Gelombang, Pemasangan Dengan Pin, BNC (PMAD4143_)
- Kombinasi GNSS (GPS/Galileo/QZSS/GLONASS), UHF, 403–430 MHz, 1/4 Gelombang, Pemasangan Dengan Pin, BNC (PMAE4035_)
- Kombinasi GNSS (GPS/Galileo/QZSS/GLONASS), UHF, 406–420 MHz, Penguatan 3,5 dB, Pemasangan Dengan Pin, BNC (PMAE4036_)
- Kombinasi GNSS (GPS/Galileo/QZSS/GLONASS), UHF, 450–470 MHz, 1/4 Gelombang, Pemasangan Dengan Pin, BNC (PMAE4037_)
- Kombinasi GNSS (GPS/Galileo/QZSS/GLONASS), UHF, 450–470 MHz, Penguatan 5 dB, Pemasangan Dengan Pin, BNC (PMAE4038_)
- Antena Aktif GPS dengan Dudukan Tetap (PMAN4000_)
- Antena Aktif GPS dengan Dudukan Jendela (PMAN4001_)
- Antena Aktif GPS dengan Dudukan Magnet (PMAN4002_)
- Kombinasi GNSS (GPS/Galileo/QZSS/BeiDou-2), NMO Mount Base, BNC (PMAN4003_)
- VHF, 136–144 MHz, Gelombang 1/4, Pemasangan dengan Pin, BNC (RAD4198_)
- VHF, 146–150,8 MHz, Gelombang 1/4, Pemasangan dengan Pin, BNC (RAD4199_)
- VHF, 150,8–162 MHz, Gelombang 1/4, Pemasangan dengan Pin, BNC (RAD4200_)
- VHF, 162–174 MHz, Gelombang 1/4, Pemasangan dengan Pin, BNC (RAD4201_)
- Kombinasi GNSS (GPS/Galileo/QZSS/GLONASS), VHF, 136–144 MHz, 1/4 Gelombang, Pemasangan Dengan Pin, BNC (RAD4219_)
- Kombinasi GNSS (GPS/Galileo/QZSS/GLONASS), VHF, 146–150.8 MHz, 1/4 Gelombang, Pemasangan Dengan Pin, BNC (RAD4220_)
- Kombinasi GNSS (GPS/Galileo/QZSS/GLONASS), VHF, 150.8–162 MHz, 1/4 Gelombang, Pemasangan Dengan Pin, BNC (RAD4221_)

- Kombinasi GNSS (GPS/Galileo/QZSS/GLONASS), VHF, 162–174 MHz, 1/4 Gelombang, Pemasangan Dengan Pin, BNC (RAD4222_)
- UHF, 403–430 MHz, Gelombang 1/4, Pemasangan dengan Pin, BNC (RAE4151_)
- UHF, 450–470 MHz, Gelombang 1/4, Pemasangan dengan Pin, BNC (RAE4152_)
- UHF, 450–470 MHz, Penguatan 5,0 dB, Pemasangan dengan Pin, BNC (RAE4154_)
- UHF, 406–420 MHz, Penguatan 3,5 dB, Pemasangan dengan Pin, BNC (RAE4158_)

Untuk digunakan dengan dudukan PMAN4003_ saja:

- UHF, 494–512 MHz, Penguatan 3,0 dB, Pemasangan Dengan Pin (HAE6027_)
- UHF, 470–494 MHz, Penguatan 3,0 dB, Pemasangan Dengan Pin (HAE6028_)
- UHF, 403–527 MHz, Penguatan 2,0 dB, Pemasangan Dengan Pin (HAE6029_) (juga untuk digunakan dengan dudukan antena standar)
- UHF, 470–527 MHz, Gelombang 1/4, Pemasangan Dengan Pin (HAE6030_)
- UHF, 403–430 MHz, Gelombang 1/4 (PMAE4039_)

- UHF, 450–470 MHz, Gelombang 1/4 (PMAE4041_)
- UHF, 406–420 MHz, Penguatan 3,5 dB (PMAE4040_)
- UHF, 450–470 MHz, Penguatan 3,5 dB (PMAE4042_)
- UHF, 450–470 MHz, Penguatan 5,0 dB (PMAE4043_)
- VHF, 162–174 MHz, Gelombang 1/4 (RAD4223_)
- VHF, 150,8–162 MHz, Gelombang 1/4 (RAD4224_)
- VHF, 146–150,8 MHz, Gelombang 1/4 (RAD4225_)
- VHF, 136–144 MHz, Gelombang 1/4 (RAD4226_)
- VHF, 146–172 MHz, Penguatan 3,0 dB (RAD4227_)

Aksesori Audio

- Headset Bluetooth HK200 dengan Konektor AS (89409N)
- Headset Bluetooth HK200 dengan Konektor Inggris (ASMHK200VP-GB2A)
- Headset Bluetooth HK200 dengan Konektor Eropa (ASMHK200-GB3A)
- Headset Bluetooth HK200 dengan Konektor Korea (ASMHK200-KR2A)
- Headset Bluetooth HK200 dengan Konektor Cina (ASMHK200-CN2A)

- Headset Bluetooth HK200 dengan Konektor Australia (ASMHK200-AU2A)
- Handset Model Telepon (HMN4098_)
- Earpiece Nirkabel Operasi Kritis, Kabel 12 inci (NNTN8125_)
- Earpiece Nirkabel Operasi Kritis, Kabel 9,5 inci (NNTN8126_)
- POD Push-to-Talk Nirkabel Operasi Kritis (NNTN8127_)
- Headset Nirkabel Tanpa Keamanan & Perangkat Push-to-Talk dengan Audio Push-to-Talk, Kabel 12 Inci (NNTN8189_)
- Kit Aksesori Bluetooth, SP, Kabel 9,5 inci (NNTN8190_)
- Kit Nirkabel Tersamar, meliputi dua set Earbud 2-Kabel (1 Hitam dan 1 Putih), Earbud 1-Kabel (Hitam), dan Adaptor 3,5 mm untuk headphone yang tersedia di pasaran (NNTN8296_) ¹⁴
- Adaptor Y Nirkabel Kalung dan kait untuk Kit yang Sepenuhnya Tersamar (NNTN8385_) ¹⁶
- Kit Aksesori Bisnis Nirkabel (PMLN6463_)
- Mikrofon Speaker Jarak Jauh Nirkabel R2.17A (PMMN4095_)
- Gateway Mikrofon Mobile Nirkabel R2.17 (PMMN4097_)
- Earpiece Putar Fleksibel dengan Mikrofon Tangkai (PMLN7181_) ¹⁶
- Earpiece Putar Fleksibel dengan Mikrofon Tangkai, Multipack (PMLN7203_) ¹⁶
- Kit Earpiece yang Sepenuhnya Tersamar (RLN4922_) ¹⁶
- Headset Nirkabel Heavy Duty Tanpa Keamanan XBT di Belakang Leher (RLN6490_)
- Headset Nirkabel Heavy Duty Tanpa Keamanan XBT di Atas Kepala (RLN6491_)
- Earpiece Putar dengan Mikrofon In-Line untuk Pod Kit Aksesori Bluetooth, Paket isi 3 (RLN6550_) ¹⁶
- Mikrofon Desktop (RMN5050_)
- Mikrofon Ringkas (RMN5052_)
- Mikrofon Keypad Navigasi 4 Arah IMPRES (RMN5127_)
- Mikrofon Tugas Berat dengan Audio yang Disempurnakan (RMN5053_)

¹⁴ Radio Anda kompatibel dengan aksesori yang tercantum di sini. Hubungi penyalur Anda untuk detailnya.

- Mikrofon Visor dengan Audio yang Disempurnakan (RMN5054_)

Kabel

- Kabel Pengganti Mikrofon Kompak (3075336B07)
- Kabel Pengganti Mikrofon Tugas Berat/Keypad (3075336B10)
- Kabel Daya ke Baterai, Kabel 10 kaki (3 meter), 15 amp (1–25 Watt) (HKN4137_)
- Kabel Daya ke Baterai, Kabel 10 kaki (3 meter), 20 amp (1–45 Watt) (HKN4191_)
- Kabel Daya ke Baterai, Kabel 20 kaki (6 meter), 20 amp (1–45 Watt) (HKN4192_)
- Kabel Pemrograman (MMP) Depan Seluler (HKN6184_)
- Kabel Pemrograman MAP (PMKN4010_)
- Kabel Pemrograman dan Tes MAP (PMKN4016_)
- Kabel Universal Konektor Aksesori Belakang Radio Mobile dan Repeater (PMKN4018_)
- Kabel Ekstensi Mikrofon Bergerak, 10 kaki (PMKN4033_)
- Kabel Ekstensi Mikrofon Bergerak, 20 kaki (PMKN4034_)

- Kabel Dudukan Jauh (3 meter) (PMKN4143_)
- Kabel Dudukan Jauh (5 meter) (PMKN4144_)
- Kabel Deteksi Penyalaan (RKN4136_)

Aksesori Desktop

- Kabel AS (3060665A04)
- Kabel Daya Radio untuk GPN6145 (GKN6266_)
- Dudukan Desktop tanpa Speaker (GLN7318_)
- Catu Daya mode alih (Model 1 – 25 Watt) (ditandai CE) (GPN6145_)
- Catu Daya dan Kabel (HPN4007_)
- Catu Daya 14 Volt 15 Amp UNI 117/240 VAC, Konektor Inggris (HPN4011_)
- Catu Daya 14 Volt 15 Amp UNI 117/240 VAC, Konektor Inggris (HPN4007_)
- Kit Perangkat Keras untuk Konektor Aksesori Belakang (PMLN5072_)
- Dudukan Desktop dengan Speaker (RSN4005_)

Kit Pemasangan

- Pelindung Layar, Transparan (satu pak berisi satu unit) (AY000269A01_) ¹⁵
- Kit Dudukan Dasbor (DIN) (RLN6465_)
- Kit Trunion Profil Rendah (RLN6466_)
- Kit Trunion Profil Tinggi (RLN6467_)
- Kit Trunion Penguncian Tombol (RLN6468_)
- Trunion Profil Rendah – Tas (RLN6469_)
- Antarmuka Penerima Transmisi Pemasangan Jauh (PMLN6402_)
- Antarmuka Control Head Pemasangan Jauh (PMLN6403_)

Aksesori Lainnya

- Pelindung Lonjakan, Tower Mount Kit (DQT1)
- Pelindung Lonjakan, Coax Protector Bulkhead (DSISB50LNC2MA)
- Adaptor Antena PL259/Mini-U, Kabel 2,4 meter (8 kaki) (HKN9557_)

- Klip Gantungan Mikrofon (Semua Mikrofon) (HLN9073_)
- Klip Gantungan Mikrofon Universal (Semua Mikrofon) (HLN9414_)
- Adaptor Non-PC IMPRES Mobile MMP (PMKN4072_)
- Adaptor Non-PC IMPRES Mobile MAP (PMKN4070_)
- Papan Opsi Generik (PMLN5718_S)
- Kit Pengawasan 1-Kabel Operasi Kritis dengan kabel transparan (PMLN7052_) ¹⁶
- Tombol PTT (RLN5926_)
- Sakelar Kaki Darurat (RLN5929_)

Speaker

- Speaker Eksternal 13 W (RSN4002_)
- Speaker Eksternal 7,5 W (RSN4003_)
- Speaker Eksternal 5 W (RSN4004_)

¹⁵ Radio Anda kompatibel dengan aksesori yang tercantum di sini. Hubungi penyalur Anda untuk detailnya.

¹⁶ Radio Anda kompatibel dengan aksesori yang tercantum di sini. Hubungi penyalur Anda untuk detailnya.

Motorola Solutions Malaysia Sdn. Bhd.
Plot 2A, Medan Bayan Lepas,
Mukim 12, S.W.D.
11900 Bayan Lepas, Penang,
Malaysia.

Recommended Dealer:
www.hkrsolutions.com

HKRSolutions
Two-way Radio & Accessories Specialist

MOTOROLA, MOTO, MOTOROLA SOLUTIONS and the Stylized M Logo are trademarks or registered trademarks of Motorola Trademark Holdings, LLC and are used under license. All other trademarks are the property of their respective owners. © 2017 and 2019 Motorola Solutions, Inc. All rights reserved.

