



PROFESSIONAL DIGITAL TWO-WAY RADIO

MOTOTRBO™
XPR™ 7350/XPR 7380
NON-DISPLAY PORTABLE
USER GUIDE

Contents

Declaration of Conformity..... 8

Important Safety Information..... 10

Software Version..... 11

Computer Software Copyrights.... 12

Handling Precautions..... 13

Getting Started..... 14

How to Use This Guide..... 14

What Your Dealer/System Administrator

Can Tell You..... 14

Preparing Your Radio for Use..... 16

Charging the Battery..... 16

Attaching the Battery..... 16

Attaching the Antenna..... 17

Attaching the Belt Clip..... 17

Attaching the Universal Connector Cover

(Dust Cover)..... 18

Powering Up the Radio..... 18

Adjusting the Volume..... 19

Identifying Radio Controls..... 20

Radio Controls..... 20

Non-Connect Plus Operations..... 21



Additional Radio Controls

in Non-Connect Plus

Mode..... 22





Push-To-Talk (PTT) Button..... 22

Programmable Buttons..... 22

Assignable Radio Functions.....	23
Assignable Settings or Utility Functions.....	25
Identifying Status Indicators.....	25
LED Indicator.....	25
Audio Tones.....	27
Indicator Tones.....	27
Switching Between Conventional Analog and Digital Mode.....	27
IP Site Connect 	28
Capacity Plus 	29
Linked Capacity Plus 	29





Making and Receiving Calls in Non-Connect Plus

Mode.....	31
Selecting a Zone.....	31
Selecting a Channel.....	31
Receiving and Responding to a Radio Call.....	31
Receiving and Responding to a Group Call.....	32
Receiving and Responding to a Private Call 	32

Receiving an All Call	33
Receiving and Responding to a Selective Call 	34
Receiving and Responding to a Phone Call 	34
Making a Radio Call.....	35
Making a Group Call.....	35
Making a Private Call 	36
Making an All Call	37
Making a Selective Call 	37
Making a Phone Call.....	38
Making a Private Call with a One Touch Call Button.....	38
Stopping a Radio Call 	39
Talkaround.....	39
Monitoring Features.....	40
Monitoring a Channel.....	40
Permanent Monitor.....	40

Advanced Features in Non- Connect Plus Mode..... 41

Scan Lists.....	41
Scan.....	41
Starting and Stopping Scan.....	41

Responding to a Transmission During a Scan.....	42	Sending an Emergency Alarm with Voice to Follow 	46
Deleting a Nuisance Channel...42		Reinitiating an Emergency Mode.....	47
Restoring a Nuisance Channel.....	42	Exiting Emergency Mode After Sending the Emergency Alarm.....	48
Vote Scan 	43	Text Message Features	48
Call Indicator Settings.....	43	Sending a Quick Text Message with the One Touch Access Button.....	48
Escalating Alarm Tone Volume.....	43	Privacy 	48
Call Alert Operation.....	43	Multi-Site Controls 	49
Receiving and Responding to a Call Alert.....	43	Starting an Automatic Site Search.....	49
Making a Call Alert with the One Touch Access Button.....	43	Stopping an Automatic Site Search.....	50
Emergency Operation.....	44	Starting a Manual Site Search.....	50
Receiving an Emergency Alarm.....	44	Lone Worker.....	50
Exiting Emergency Mode After Receiving the Emergency Alarm.....	45	Password Lock Features.....	51
Sending an Emergency Alarm.....	45	Accessing the Radio from Password.....	51
Sending an Emergency Alarm with Call.....	45	Unlocking the Radio from Locked State.....	51

Bluetooth Operation.....	52	Setting the Text-to-Speech Feature.....	55
Disconnecting from a Bluetooth Device.....	52	Switching Audio Route between Internal Radio Speaker and Wired Accessory.....	56
Switching Audio Route between Internal Radio Speaker and Bluetooth Device.....	53	Intelligent Audio.....	56
Permanent Bluetooth Discoverable Mode.....	53	Turning the Acoustic Feedback Suppressor Feature On or Off.....	56
Auto-Range Transponder System (ARTS).....	53	Turning Trill Enhancement On or Off.....	57
Over-the-Air-Programming (OTAP)....	53	Turning the Global Positioning System (GPS) On or Off.....	57
Utilities.....	54	Flexible Receive List.....	57
Setting the Power Level.....	54		
Turning the Option Board Feature(s) On or Off.....	54		
Turning the Voice Operating Transmission (VOX) Feature On or Off.....	54		
Turning the Radio Tones/ Alerts On or Off.....	55		
Checking the Battery Strength.....	55		
Turning the Voice Announcement On or Off....	55		
		Connect Plus Operations.....	58
		Additional Radio Controls in Connect Plus Mode.....	59
		Push-To-Talk (PTT) Button.....	59
		Programmable Buttons.....	59
		Assignable Radio Functions.....	60

Assignable Settings or Utility Functions.....	61
Identifying Status Indicators in Connect Plus Mode.....	62
LED Indicator.....	62
Indicator Tones.....	63
Audio Tones.....	63
Switching Between Connect Plus and Non-Connect Plus Modes.....	63

Making and Receiving Calls in Connect Plus Mode..... 65

Selecting a Site.....	65
Roam Request.....	65
Site Lock On/Off.....	65
Selecting a Zone.....	65
Using Multiple Networks.....	66
Selecting a Call Type.....	66
Receiving and Responding to a Radio Call.....	66
Receiving and Responding to a Group Call.....	67
Receiving and Responding to a Private Call.....	67
Receiving a Site All Call.....	68

Receiving an Inbound Private Phone Call.....	68
Receiving an Inbound Phone Talkgroup Call.....	68
Inbound Phone Multi-Group Call.....	68
Making a Radio Call.....	69
Making a Call	69
Making a Private Call with a One Touch Call Button.....	71

Advanced Features in Connect Plus Mode..... 72

Auto Fallback.....	72
Indications of Auto Fallback Mode.....	72
Making/Receiving Calls in Fallback Mode.....	72
Returning to Normal Operation.....	73
Scan.....	73
Starting and Stopping Scan.....	73
Responding to a Transmission During a Scan.....	74

Turning Scan On or Off.....	74	Resetting the Beacon.....	82
Understanding Scan Operation.....	74	Text Message Features.....	83
Scan Talkback.....	75	Sending a Quick Text	
Call Indicator Settings.....	75	Message with the One	
Escalating Alarm Tone		Touch Access Button.....	83
Volume.....	75	Privacy.....	83
Call Alert Operation.....	75	Making a Privacy-Enabled	
Receiving and Responding		(Scrambled) Call.....	84
to a Call Alert.....	76	Bluetooth Operation.....	84
Making a Call Alert with the		Finding and Connecting to a	
One Touch Access		Bluetooth Device.....	85
Button.....	76	Disconnecting from a	
Emergency Operation.....	76	Bluetooth Device.....	85
Responding to an		Switching Audio Route	
Emergency Call.....	77	between Internal Radio	
Initiating an Emergency Call....	78	Speaker and Bluetooth	
Initiating an Emergency Call		Device.....	85
with Voice to Follow.....	78	Permanent Bluetooth	
Initiating an Emergency Alert...	79	Discoverable Mode.....	85
Exiting Emergency Mode.....	79	Utilities.....	86
Man Down Alarms.....	80	Turning the Radio Tones/	
Turning Man Down Alarms		Alerts On or Off.....	86
On and Off.....	81	Setting the Power Level.....	86
Resetting the Man Down		Voice Announcement.....	86
Alarms.....	81	Checking the Battery	
Beacon Feature.....	82	Strength.....	86
Turning Beacon On and Off....	82	Intelligent Audio.....	87

Turning the Acoustic Feedback Suppressor Feature On or Off.....	87	Non-Commercial Call Channel.....	94
Turning the Global Positioning System (GPS) On or Off.....	87	Operating Frequency Requirements.....	94
Accessories.....	88	Declaration of Compliance for the Use of Distress and Safety Frequencies.....	97
Authorized Accessories List.....	89	Technical Parameters for Interfacing External Data Sources.....	97
Antennas.....	89	Batteries and Chargers Warranty.....	98
Batteries.....	89	The Workmanship Warranty.....	98
Carry Devices.....	90	The Capacity Warranty.....	98
Chargers.....	90	Limited Warranty.....	99
Earbuds and Earpieces.....	90	MOTOROLA COMMUNICATION PRODUCTS.....	99
Headsets and Headset Accessories...	91	I. WHAT THIS WARRANTY COVERS AND FOR HOW LONG:.....	99
Remote Speaker Microphones.....	91	II. GENERAL PROVISIONS:.....	100
Surveillance Accessories.....	92	III. STATE LAW RIGHTS:.....	100
Miscellaneous Accessories.....	93	IV. HOW TO GET WARRANTY SERVICE:.....	100
Maritime Radio Use in the VHF Frequency Range.....	94	V. WHAT THIS WARRANTY DOES NOT COVER:.....	101
Special Channel Assignments.....	94	VI. PATENT AND SOFTWARE PROVISIONS:.....	101
Emergency Channel.....	94	VII. GOVERNING LAW:.....	103

Declaration of Conformity

This declaration is applicable to your radio only if your radio is labeled with the FCC logo shown below.

Declaration of Conformity

Per FCC CFR 47 Part 2 Section 2.1077(a)



Responsible Party

Name: Motorola Solutions, Inc.

Address: 1303 East Algonquin Road, Schaumburg, IL 60196-1078, U.S.A.

Phone Number: 1-800-927-2744

Hereby declares that the product:

Model Name: **XPR 7350/XPR 7380**

conforms to the following regulations:

FCC Part 15, subpart B, section 15.107(a), 15.107(d) and section 15.109(a)

Class B Digital Device

As a personal computer peripheral, this device complies with Part 15 of the FCC Rules. This device complies with Industry Canada licence-exempt RSS standard(s). Operation is subject to the following two conditions:

- 1 This device may not cause harmful interference, and
- 2 This device must accept any interference received, including interference that may cause undesired operation.

Note: This equipment has been tested and found to comply with the limits for a Class B digital device, pursuant to part 15 of the FCC Rules. These limits are designed to provide reasonable protection against harmful interference in a residential installation. This equipment generates, uses and can radiate radio frequency energy and, if not installed and used in accordance with the instructions, may cause harmful interference to radio communications. However, there is no guarantee that interference will not occur in a particular installation.

If this equipment does cause harmful interference to radio or television reception, which can be determined by turning the equipment off and on, the user is encouraged to try to correct the interference by one or more of the following measures:

- Reorient or relocate the receiving antenna.
- Increase the separation between the equipment and receiver.
- Connect the equipment into an outlet on a circuit different from that to which the receiver is connected.
- Consult the dealer or an experienced radio/TV technician for help.

Important Safety Information

RF Energy Exposure and Product Safety Guide for Portable Two-Way Radios

ATTENTION!

This radio is restricted to Occupational use only.

Before using the radio, read the RF Energy Exposure and Product Safety Guide for Portable Two-Way Radios which contains important operating instructions for safe usage and RF energy awareness and control for Compliance with applicable standards and Regulations.

For a list of Motorola-approved antennas, batteries, and other accessories, visit the following website:

<http://www.motorolasolutions.com>

Any modification to this device, not expressly authorized by Motorola, may void the user's authority to operate this device.

Under Industry Canada regulations, this radio transmitter may only operate using an antenna of a type and maximum (or lesser) gain approved for the transmitter by Industry Canada. To reduce potential radio interference to other users, the antenna type

and its gain should be so chosen that the equivalent isotropically radiated power (e.i.r.p.) is not more than that necessary for successful communication.

This radio transmitter has been approved by Industry Canada to operate with Motorola-approved antenna with the maximum permissible gain and required antenna impedance for each antenna type indicated. Antenna types not included in this list, having a gain greater than the maximum gain indicated for that type, are strictly prohibited for use with this device.

Software Version

All the features described in the following sections are supported by the radio's software version **R02.40.00** or later.

Check with your dealer or system administrator for more details of all the features supported.

Computer Software Copyrights

The Motorola products described in this manual may include copyrighted Motorola computer programs stored in semiconductor memories or other media. Laws in the United States and other countries preserve for Motorola certain exclusive rights for copyrighted computer programs including, but not limited to, the exclusive right to copy or reproduce in any form the copyrighted computer program. Accordingly, any copyrighted Motorola computer programs contained in the Motorola products described in this manual may not be copied, reproduced, modified, reverse-engineered, or distributed in any manner without the express written permission of Motorola. Furthermore, the purchase of Motorola products shall not be deemed to grant either directly or by implication, estoppel, or otherwise, any license under the copyrights, patents or patent applications of Motorola, except for the normal non-exclusive license to use that arises by operation of law in the sale of a product.

The AMBE+2™ voice coding Technology embodied in this product is protected by intellectual property rights

including patent rights, copyrights and trade secrets of Digital Voice Systems, Inc.

This voice coding Technology is licensed solely for use within this Communications Equipment. The user of this Technology is explicitly prohibited from attempting to decompile, reverse engineer, or disassemble the Object Code, or in any other way convert the Object Code into a human-readable form.

U.S. Pat. Nos. #5,870,405, #5,826,222, #5,754,974, #5,701,390, #5,715,365, #5,649,050, #5,630,011, #5,581,656, #5,517,511, #5,491,772, #5,247,579, #5,226,084 and #5,195,166.

Handling Precautions

The MOTOTRBO Series Digital Portable radio meets IP57 specifications, allowing the radio to withstand adverse field conditions such as being submersed in water.

- If the radio has been submersed in water, shake the radio well to remove any water that may be trapped inside the speaker grille and microphone port. Trapped water could cause decreased audio performance.
- If the radio's battery contact area has been exposed to water, clean and dry battery contacts on both the radio and the battery before attaching the battery to the radio. The residual water could short-circuit the radio.
- If the radio has been submersed in a corrosive substance (e.g. saltwater), rinse the radio and battery in fresh water then dry the radio and battery.
- To clean the exterior surfaces of the radio, use a diluted solution of mild dishwashing detergent and fresh water (i.e. one teaspoon of detergent to one gallon of water).

- Never poke the vent (hole) located on the radio chassis below the battery contact. This vent allows for pressure equalization in the radio. Doing so may create a leak path into the radio and the radio's submersibility may be lost.
- Never obstruct or cover the vent, even with a label.
- Ensure that no oily substances come in contact with the vent.
- The radio with antenna attached properly is designed to be submersible to a maximum depth of 1 meter (3.28 feet) and a maximum submersion time of 30 minutes. Exceeding either maximum limit or use without antenna may result in damage to the radio.
- When cleaning the radio, do not use a high pressure jet spray on the radio as this will exceed the 1 meter depth pressure and may cause water to leak into the radio.



Caution: Do not disassemble the radio. This could damage radio seals and result in leak paths into the radio. Radio maintenance should only be done in service depot that is equipped to test and replace the seal on the radio.



Getting Started

How to Use This Guide

This User Guide covers the basic operation of the MOTOTRBO Portables.

However, your dealer or system administrator may have customized your radio for your specific needs. Check with your dealer or system administrator for more information.

Throughout this publication, the icons described next are used to indicate features supported in either the conventional Analog mode or conventional Digital mode:

	Indicates a conventional Analog Mode-Only feature.
	Indicates a conventional Digital Mode-Only feature.

For features that are available in **both** conventional Analog and Digital modes, **no** icon is shown.

Conventional Analog Mode-Only features are not available in Connect Plus mode of operation. See [Connect Plus Operations](#) on page 58 for more information.

For features that are available in a conventional multi-site mode, see [IP Site Connect](#) on page 28 for more information.

Selected features are **also** available on the single-site trunking mode, **Capacity Plus**. See [Capacity Plus](#) on page 29 for more information.

Selected features are **also** available in the multi-site trunking mode, **Linked Capacity Plus**. See [Linked Capacity Plus](#) on page 29 for more information.

What Your Dealer/System Administrator Can Tell You

You can consult your dealer or system administrator about the following:

- Is your radio programmed with any preset conventional channels?
- Which buttons have been programmed to access other features?
- What optional accessories may suit your needs?

- What are the best radio usage practices for effective communication?
- What maintenance procedures will help promote longer radio life?

Preparing Your Radio for Use

Charging the Battery

For best performance, your radio is powered by a Motorola-approved Nickel Metal-Hydride (NiMH) or Lithium-Ion (Li-Ion) battery. To avoid damage and to ensure compliance with warranty terms, charge the battery using a Motorola charger *exactly* as described in the charger user guide. It is recommended your radio remains powered off while charging.

Charge a new battery 14 to 16 hours before initial use for best performance.

Attaching the Battery

- 1 Align the battery with the rails on the back of the radio. Press the battery firmly, and slide upwards until the latch snaps into place. Slide battery latch into lock position.

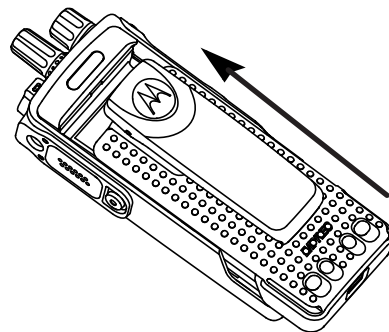

- 2 To remove the battery, turn the radio off. Move the battery latch (A) into unlock position and hold, and slide the battery down and off the rails.

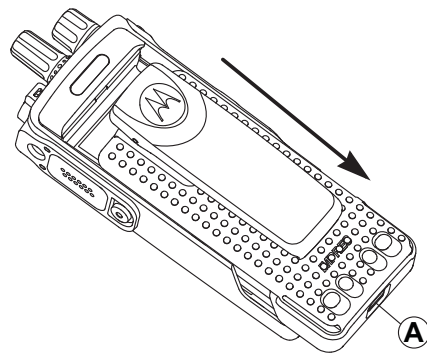

Attaching the Antenna



Caution: If antenna needs to be replaced, ensure that only MOTOTRBO antennas are used. Neglecting this will damage your radio.

- 1 With the radio turned off, set the antenna in its receptacle and turn clockwise.

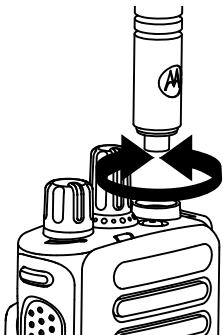

- 2 To remove the antenna, turn the antenna counterclockwise.

Attaching the Belt Clip

- 1 To attach the belt clip, align the grooves on the clip with those on the battery and press downward until you hear a click.

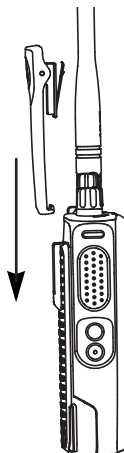

- 2 To remove the belt clip, press the belt clip tab away from the battery using a key. Then slide the clip upward and away from the radio.

Attaching the Universal Connector Cover (Dust Cover)

The universal connector (A) is located on the antenna side of the radio. It is used to connect MOTOTRBO accessories to the radio.

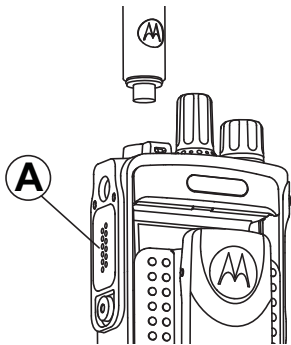

Insert the hooked end of the cover into the slots above the universal connector. Press downward on the cover to seat the lower tab properly into the RF connector.

Turn the thumbscrew clockwise to secure the connector cover to the radio.

To remove the universal connector cover, press down on the cover and turn the thumbscrew counterclockwise.

Replace the dust cover when the universal connector is not in use.

Powering Up the Radio

Rotate the **On/Off/Volume Control Knob** clockwise until you hear a click. You see a welcome message or welcome image.

The LED lights up solid green (A).

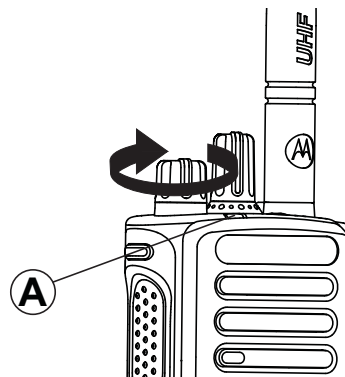

A brief tone sounds, indicating that the power up test is successful.

Note: There is no power up tone if the radio tones/alerts function is disabled (see [Turning the Radio Tones/Alerts On or Off](#) on page 55).

If your radio does not power up, check your battery. Make sure that it is charged and properly attached. If your radio still does not power up, contact your dealer.

To turn off the radio, rotate this knob counterclockwise until you hear a click.

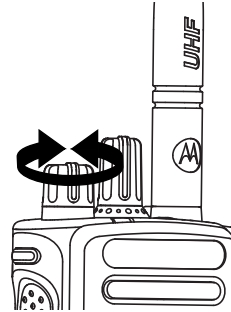

Adjusting the Volume

To increase the volume, turn the **On/Off/Volume Control Knob** clockwise.

To decrease the volume, turn this knob counterclockwise.

Note: Your radio can be programmed to have a minimum volume offset where the volume level cannot be lowered past the programmed minimum volume. Check with your dealer or system administrator for more information.

Identifying Radio Controls

Radio Controls

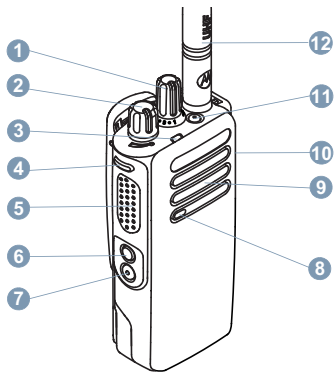

- 1 Channel Selector Knob
- 2 On/Off/Volume Control Knob
- 3 LED Indicator
- 4 Side Button 1^[1]
- 5 Push-to-Talk (**PTT**) Button

- 6 Side Button 2^[1]
- 7 Side Button 3^[1]
- 8 Microphone
- 9 Speaker
- 10 Universal Connector for Accessories
- 11 Emergency Button^[1]
- 12 Antenna

¹ These buttons are programmable.

Non-Connect Plus Operations

Additional Radio Controls in Non-Connect Plus Mode

Push-To-Talk (PTT) Button

The **PTT** button on the side of the radio (A) serves two basic purposes:

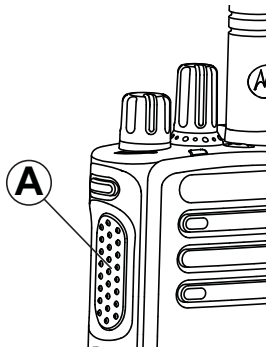

- While a call is in progress, the **PTT** button allows the radio to transmit to other radios in the call.

Press and hold down **PTT** button to talk. Release the **PTT** button to listen.

The microphone is activated when the **PTT** button is pressed.

- While a call is not in progress, the **PTT** button is used to make a new call (see [Making a Radio Call](#) on page 35).

If the Talk Permit Tone or the **PTT** Sidetone (PT) is enabled, wait until the short alert tone ends before talking.

During a call, if the Channel Free Indication feature is enabled on your radio (programmed by your dealer), you will hear a short alert tone the moment the target radio (the radio that is receiving your call) releases the **PTT** button, indicating the channel is free for you to respond.

You will also hear a continuous talk prohibit tone, if your call is interrupted, indicating that you should release the **PTT** button, for example when the radio receives an Emergency Call.

Programmable Buttons

Your dealer can program the programmable buttons as shortcuts to radio functions depending on the duration of a button press:

- Short press – Pressing and releasing rapidly.
- Long press – Pressing and holding for the programmed duration.
- Hold down – Keeping the button pressed.

Note: The programmed duration of a button press is applicable for all assignable radio/utility functions or settings. See [Emergency Operation](#) on page 44 for more information on the programmed duration of the **Emergency** button.

Assignable Radio Functions

Audio Toggle	Toggles audio routing between the internal radio speaker and the speaker of wired accessory.
Battery Strength	Indicates battery strength via the LED Indicator.
Bluetooth® Audio Switch	Toggles audio routing between internal radio speaker and external Bluetooth-enabled accessory.
Bluetooth Connect	Initiates a Bluetooth find-and-connect operation.

Bluetooth Disconnect

Terminates all existing Bluetooth connections between your radio and any Bluetooth-enabled devices.

Bluetooth Discoverable

Enables your radio to enter Bluetooth Discoverable Mode.

Call Forwarding

Toggles Call Forwarding on or off.

Emergency

Depending on the programming, initiates or cancels an emergency.

Intelligent Audio

Toggles intelligent audio on or off.

Manual Site Roam^[2]

Starts the manual site search.

Mic AGC On/Off







Toggles the internal microphone automatic gain control (AGC) on or off.

Monitor

Monitors a selected channel for activity.

Notifications

Provides direct access to the Notifications list.

Nuisance Channel Delete^[2]	Temporarily removes an unwanted channel, except for the Selected Channel, from the scan list. The Selected Channel refers to the user's selected zone/channel combination from which scan is initiated.	Scan^[2]	Toggles scan on or off.
One Touch Access 	Directly initiates a predefined Private, Phone or Group Call, a Call Alert or a Quick Text message.	Site Info	Plays site announcement voice messages for the current site (this function is unavailable when Voice Announcement is disabled).
Option Board Feature	Toggles option board feature(s) on or off for option board-enabled channels.	Site Lock On/Off^[2] 	When toggled on, the radio searches the current site only. When toggled off, the radio searches other sites in addition to the current site.
Permanent Monitor	Monitors a selected channel for all radio traffic until function is disabled.	Telemetry Control 	Controls the Output Pin on a local or remote radio.
Phone Exit 	Ends a Phone Call.	Transmit Interrupt Remote Dekey 	Stops the transmission of a remote monitored radio without giving any indicators, or an ongoing interruptible call to free the channel.
Privacy 	Toggles privacy on or off.	Voice Announcement for Channel	Plays zone and channel announcement voice messages for the current channel. This function is
Repeater/Talkaround^[2]	Toggles between using a repeater and communicating directly with another radio.		

	unavailable when Voice Announcement is disabled.
Voice Announcement On/Off	Toggles voice announcement on or off.
Voice Operating Transmission (VOX)	Toggles VOX on or off.
Zone	Allows selection from a list of zones.

Assignable Settings or Utility Functions

All Tones/ Alerts	Toggles all tones and alerts on or off.
Power Level	Toggles transmit power level between high and low.

Identifying Status Indicators

LED Indicator

The LED indicator (A) shows the operational status of your radio.

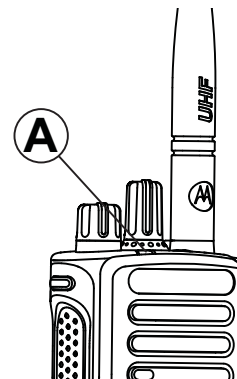

Blinking red

Radio is transmitting at low battery condition, receiving an emergency transmission, has failed the self-test upon powering up, or has moved out of range if radio is configured

² Not applicable in Capacity Plus and Linked Capacity Plus

	with Auto-Range Transponder System.
Solid yellow	Radio is monitoring a conventional channel or in Bluetooth Discoverable Mode. Also indicates fair battery charge when programmable button is pressed.
Blinking yellow	Radio is scanning for activity or receiving a Call Alert, flexible receive list is enabled or all local Linked Capacity Plus channels are busy.
Double blinking yellow	Radio is no longer connected to the repeater while in Capacity Plus or Linked Capacity Plus; all Capacity Plus or Linked Capacity Plus channels are currently busy. Auto Roaming is enabled, radio is actively searching for a

	new site. Also indicates that radio has yet to respond to a group call alert, or radio is locked.
Solid green	Radio is powering up or transmitting. Also indicates full charge of the battery when the programmed Battery Strength button is pressed.
Blinking green	Radio is powering up, receiving a non-privacy-enabled call or data, or detecting activity, or retrieving Over-the-Air Programming transmissions over the air.
Double blinking green 	Radio is receiving a privacy-enabled call or data.





Note: While in conventional mode, when the LED blinks green, it indicates the radio detects activity over the air. Due to the nature of the digital protocol,

this activity may or may not affect the radio's programmed channel.



For Capacity Plus and Linked Capacity Plus, there is no LED indication when the radio is detecting activity over the air.

Audio Tones

Audio tones provide you with audible indications of the status, or response to data received on the radio.

<p>Continuous Tone</p> 	<p>A monotone sound. Sounds continuously until termination.</p>
<p>Periodic Tone</p> 	<p>Sounds periodically depending on the duration set by the radio. Tone starts, stops, and repeats itself.</p>
<p>Repetitive Tone</p> 	<p>A single tone that repeats itself until it is terminated by the user.</p>
<p>Momentary Tone</p> 	<p>Sounds only once for a short period of time defined by the radio.</p>

Indicator Tones

High pitched tone	<input type="checkbox"/>	Low pitched tone	<input checked="" type="checkbox"/>
		Positive Indicator Tone	
		Negative Indicator Tone	

Switching Between Conventional Analog and Digital Mode

Each channel in your radio can be configured as a conventional analog or conventional digital channel. Use the Channel Selector Knob (A) to switch between an analog or a digital channel.

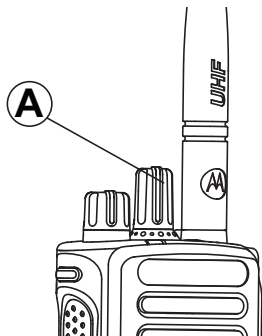

When switching from digital to analog mode, certain features are unavailable. Icons for the digital features (such as Messages) reflect this change by appearing 'grayed out'. Disabled features are hidden in the menu.

Your radio also has features available in both analog and digital mode. However, the minor differences in the way each feature works does **not** affect the performance of your radio.

Note: Your radio also switches between digital and analog modes during a dual mode scan (see [Scan](#) on page 41).

IP Site Connect

This feature allows your radio to extend conventional communication beyond the reach of a single site, by connecting to different available sites which are connected via an Internet Protocol (IP) network.

When the radio moves out of range from one site and into the range of another, it connects to the new site's repeater to send or receive calls/data transmissions. Depending on your settings, this is done automatically or manually.

If the radio is set to do this automatically, it scans through all available sites when the signal from the current site is weak or when the radio is unable to detect any signal from the current site. It then locks on to the repeater with the strongest Received Signal Strength Indicator (RSSI) value.

In a manual site search, the radio searches for the next site in the roam list that is currently in range (but which may not have the strongest signal) and locks on to it.

Note: Each channel can only have either Scan or Roam enabled, not both at the same time.

Channels with this feature enabled can be added to a particular roam list. The radio searches the channel(s) in the roam list during the automatic roam operation to locate the best site.

A roam list supports a maximum of 16 channels (including the Selected Channel).

Note: You cannot manually add or delete an entry to the roam list. Check with your dealer or system administrator for more information.

Capacity Plus

Capacity Plus is a single-site trunking configuration of the MOTOTRBO radio system, which uses a pool of channels to support hundreds of users and up to 254 Groups. This feature allows your radio to efficiently utilize the available number of programmed channels while in Repeater Mode.

You hear a negative indicator tone if you try to access a feature not applicable to Capacity Plus via a programmable button press.

Your radio also has features that are available in conventional digital mode, IP Site Connect, Capacity Plus and Linked Capacity Plus. However, the minor

differences in the way each feature works does **not** affect the performance of your radio.

Check with your dealer or system administrator for more information on this configuration.

Linked Capacity Plus

Linked Capacity Plus is a multi-site multi-channel trunking configuration of the MOTOTRBO radio system, combining the best of both Capacity Plus and IP Site Connect configurations.

Linked Capacity Plus allows your radio to extend trunking communication beyond the reach of a single site, by connecting to different available sites which are connected via an Internet Protocol (IP) network. It also provides an increase in capacity by efficiently utilizing the combined available number of programmed channels supported by each of the available sites.

When the radio moves out of range from one site and into the range of another, it connects to the new site's repeater to send or receive calls/data transmissions. Depending on your settings, this is done automatically or manually.

If the radio is set to do this automatically, it scans through all available sites when the signal from the current site is weak or when the radio is unable to detect any signal from the current site. It then locks on to the repeater with the strongest Received Signal Strength Indicator (RSSI) value.

In a manual site search, the radio searches for the next site in the roam list that is currently in range (but which may not have the strongest signal) and locks on to it.

Any channel with Linked Capacity Plus enabled can be added to a particular roam list. The radio searches these channels during the automatic roam operation to locate the best site.

Note: You cannot manually add or delete an entry to the roam list. Check with your dealer or system administrator for more information.

Similar to Capacity Plus, icons of features not applicable to Linked Capacity Plus are not available in the menu. You hear a negative indicator tone if you try to access a feature not applicable to Linked Capacity Plus via a programmable button press.

Check with your dealer or system administrator for more information on this configuration.

Making and Receiving Calls in Non-Connect Plus Mode

Selecting a Zone

A zone is a group of channels. Your radio supports up to 32 channels and 2 zones, with a maximum of 16 channels per zone.

- 1 Access the Zone feature. Press the programmed **Zone** button.
- 2 You hear a tone indicating the Zone change.

Tone	Zone Change
Positive Indicator Tone	Radio has switched from Zone 1 to Zone 2.
Negative Indicator Tone	Radio has switched from Zone 2 to Zone 1.

Selecting a Channel

Transmissions are sent and received on a channel. Depending on your radio's configuration, each

channel may have been programmed differently to support different groups of users or supplied with different features. After selecting the relevant Zone, select the relevant channel you require to transmit or receive on.

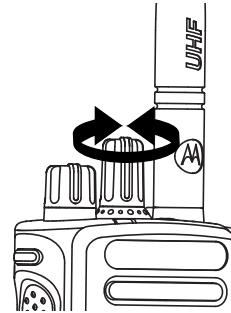

Turn the programmed Channel Selector Knob to select the channel, subscriber alias or ID, or group alias or ID.

Receiving and Responding to a Radio Call

Once the channel, subscriber ID, or group ID is set, you can proceed to receive and respond to calls.

The LED lights up solid green while the radio is transmitting and blinks green when the radio is receiving.

Note: The LED lights up solid green while the radio is transmitting and double blinks green when the radio is receiving a privacy-enabled call.

To unscramble a privacy-enabled call, your radio must have the same Privacy Key, OR the same Key Value and Key ID (programmed by your dealer), as the transmitting radio (the radio you are receiving the call from).

See [Privacy](#) on page 48 for more information. 

Receiving and Responding to a Group Call

To receive a call from a group of users, your radio must be configured as part of that group.

The LED blinks green. Your radio unmutes and the incoming call sounds through the radio's speaker.

- 1 Hold the radio vertically 1 to 2 inches (2.5 to 5.0 cm) from your mouth.
 -  If the Channel Free Indication feature is enabled, you hear a short alert tone the moment the transmitting radio releases the

PTT button, indicating the channel is free for you to respond. Press the **PTT** button to respond.

-  If the Voice Interrupt feature is enabled, press the **PTT** button to stop the current call from the transmitting radio and free the channel for you to talk/respond.

The LED lights up solid green.

- 2 Wait for one of the following tones to finish (if enabled), and speak clearly into the microphone.
 - The Talk Permit Tone.
 - The **PTT** Sidetone. 
 - 3 Release the **PTT** button to listen.
-



If there is no voice activity for a predetermined period of time, the call ends.

See [Making a Group Call](#) on page 35 for details on making a Group Call.

Receiving and Responding to a Private Call

A Private Call is a call from an individual radio to another individual radio.

When you receive a Private Call, the LED blinks green. Your radio unmutes and the incoming call sounds through the radio's speaker.

- 1 Hold the radio vertically 1 to 2 inches (2.5 to 5.0 cm) from your mouth.
 -  If the Channel Free Indication feature is enabled, you hear a short alert tone the moment the transmitting radio releases the **PTT** button, indicating the channel is free for you to respond. Press the **PTT** button to respond.
 -  If the Voice Interrupt feature is enabled, press the **PTT** button to stop the current call from the transmitting radio and free the channel for you to talk/respond.

The LED lights up solid green.

-
- 2 Wait for the Talk Permit Tone to finish (if enabled), and speak clearly into the microphone.
-
- 3 Release the **PTT** button to listen.
-

If there is no voice activity for a predetermined period of time, the call ends.

You hear a short tone.

See [Making a Private Call](#) on page 36 for details on making a Private Call.

Receiving an All Call

An All Call is a call from an individual radio to every radio on the channel. It is used to make important announcements requiring the user's full attention.

When you receive an All Call, a tone sounds and the LED blinks green.

Your radio unmutes and the incoming call sounds through the radio speaker.

An All Call does not wait for a predetermined time before ending.

 If the Channel Free Indication feature is enabled, you hear a short alert tone the moment the transmitting radio releases the **PTT** button, indicating the channel is now available for use.

You cannot respond to an All Call.

Note: The radio stops receiving the All Call if you switch to a different channel while receiving the call. During an All Call, you will **not** be able to use any programmed button functions until the call ends.

Receiving and Responding to a Selective Call

A Selective Call is a call from an individual radio to another individual radio. It is a Private Call on an analog system.

When you receive a Selective Call, the LED blinks green. Your radio unmutes and the incoming call sounds through the radio's speaker.

- 1 Hold the radio vertically 1 to 2 inches (2.5 to 5.0 cm) from your mouth.

- 2 Press the **PTT** button to respond to the call. The LED lights up solid green.

- 3 Wait for the Talk Permit Tone to finish (if enabled), and speak clearly into the microphone.

- 4 Release the **PTT** button to listen.

If there is no voice activity for a predetermined period of time, the call ends.

You hear a short tone.

See [Making a Private Call](#) on page 36 for details on making a Private Call.

Receiving and Responding to a Phone Call

Phone Call as a Private Call/Group Call

When you receive a Phone Call as a Private Call or Group Call, the LED blinks green. Your radio unmutes and the incoming call sounds through the radio's speaker.

If Phone Call capability is not enabled in your radio, your radio mutes the call.

- 1 Press the **PTT** button to talk and release it to listen.

- 2 If there is no voice activity for a predetermined period of time, the call ends. You hear a short tone.

Phone Call as All Call

When you receive a Phone Call as an All Call,

If Phone Call capability is not enabled in your radio, your radio mutes the call.

Note: When you receive a Phone Call as an All Call, you can respond to the call or end the call, only if an All Call type is assigned to the channel.

Press the **PTT** button to talk and release it to listen.

Making a Radio Call

After selecting your channel, you can select a subscriber alias or ID, or group alias or ID by using:

- The Channel Selector Knob.
- A programmed **One Touch Access** button – The One Touch Access feature allows you to make a Group or Private Call to a predefined ID easily. This feature can be assigned to a short or long programmable button press. You can **ONLY** have one ID assigned to a **One Touch Access** button. Your radio can have multiple **One Touch Access** buttons programmed. 

Note: Your radio must have the Privacy feature enabled on the channel to send a privacy-enabled transmission. Only target radios with the same Privacy Key OR the same Key Value and Key ID as your radio will be able to unscramble the transmission.

Note: See [Privacy](#) on page 48 for more information.



Making a Group Call

To make a call to a group of users, your radio must be configured as part of that group.

- 1 Do one of the following.
 - Select the channel with the active group alias or ID. See [Selecting a Channel](#) on page 31.
 - Press the programmed **One Touch Access** button.

- 2 Hold the radio vertically 1 to 2 inches (2.5 to 5.0 cm) from your mouth.

- 3 Press the **PTT** button to make the call. The LED lights up solid green.

- 4 Release the **PTT** button to listen. When the target radio responds, the LED blinks green.

- 5  If the Channel Free Indication feature is enabled, you hear a short alert tone the moment the transmitting radio releases the **PTT** button, indicating the channel is free for you to respond. Press the **PTT** button to respond.

If there is no voice activity for a predetermined period of time, the call ends.

Making a Private Call

While you can receive and/or respond to a Private Call initiated by an authorized individual radio, your radio must be programmed for you to initiate a Private Call.

There are two types of Private Calls. The first type, where a radio presence check is performed prior to setting up the call, while the other sets up the call immediately.

Only **one** of these call types can be programmed to your radio by your dealer.

You will hear a negative indicator tone, when you make a Private Call via the **One Touch Access** button, or the , if this feature is not enabled.

Use the Quick Text Message or Call Alert features to contact an individual radio. See [Text Message Features](#) on page 48 or [Call Alert Operation](#) on page 43 for more information.

- 1 Do one of the following.

- Select the channel with the active subscriber alias or ID. See [Selecting a Channel](#) on page 31.
- Press the programmed **One Touch Access** button.

- 2 Hold the radio vertically 1 to 2 inches (2.5 to 5.0 cm) from your mouth.
- 3 Press the **PTT** button to make the call. The LED lights up solid green.
- 4 Wait for the Talk Permit Tone to finish (if enabled), and speak clearly into the microphone.
- 5 Release the **PTT** button to listen. When the target radio responds, the LED blinks green.
- 6  If the Channel Free Indication feature is enabled, you hear a short alert tone the moment the transmitting radio releases the **PTT** button, indicating the channel is free for you to respond. Press the **PTT** button to respond.

If there is no voice activity for a predetermined period of time, the call ends. You hear a short tone.

Making an All Call

This feature allows you to transmit to all users on the channel. Your radio must be programmed to allow you to use this feature.

Users on the channel cannot respond to an All Call.

- 1 Select the channel with the active All Call group alias or ID. See [Selecting a Channel](#) on page 31.

 - 2 Hold the radio vertically 1 to 2 inches (2.5 to 5.0 cm) from your mouth.

 - 3 Press the **PTT** button to make the call. The LED lights up solid green.

 - 4 Wait for one of the following tones to finish (if enabled), and speak clearly into the microphone.
 - The Talk Permit Tone.
 - The **PTT** Sidetone. 
-

Making a Selective Call

Just like a Private Call, while you can receive and/or respond to a Selective Call initiated by an authorized individual radio, your radio must be programmed for you to initiate a Selective Call.

- 1 Select the channel with the active subscriber alias or ID. See [Selecting a Channel](#) on page 31.

- 2 Hold the radio vertically 1 to 2 inches (2.5 to 5.0 cm) from your mouth.

- 3 Press the **PTT** button to make the call. The LED lights up solid green.

- 4 Wait for one of the following tones to finish (if enabled), and speak clearly into the microphone.
 - The Talk Permit Tone.
 - The **PTT** Sidetone. 

- 5 Release the **PTT** button to listen. When the target radio responds, the LED blinks green.
 -  If the Channel Free Indication feature is enabled, you hear a short alert tone the moment

the transmitting radio releases the **PTT** button, indicating the channel is free for you to respond. Press the **PTT** button to respond.

If there is no voice activity for a predetermined period of time, the call ends.

Making a Phone Call

Note: When you attempt to make or end a Phone Call without the access and deaccess codes preconfigured, the attempt fails and a negative indicator tone sounds.

- 1 Press the programmed **One Touch Access** button to make a Phone Call to the predefined ID. If the entry for the **One Touch Access** button is empty, a negative indicator tone sounds. If the call-setup is successful, the DTMF tone sounds. You hear the dialing tone of the telephone user. If the call-setup is unsuccessful, a negative indicator tone sounds and the Phone Call attempt fails. Repeat Step 1.

- 2 Hold the radio vertically 1 to 2 inches (2.5 to 5.0 cm) from your mouth.
-

- 3 Press the **PTT** button to talk and release it to listen.
-

- 4 Press the programmed **Phone Exit** button to end the call.

If the end-call-setup is successful, a tone sounds and your radio exits the Phone Call.

If the end-call-setup is unsuccessful, a negative indicator tone sounds, and your radio returns to the Phone Call. Repeat Step 4 or wait for the telephone user to end the call.

Making a Private Call with a One Touch Call Button

The One Touch Call feature allows you to easily make a Private Call to a pre-defined Private Call alias or ID. This feature can be assigned to a short or long programmable button press.

You can **ONLY** have one alias or ID assigned to a One Touch Call button. Your radio can have multiple One Touch Call buttons programmed.

- 1 Press the programmed **One Touch Call** button to make a Private Call to the pre-defined Private Call alias or ID.
-

- 2 Hold the radio vertically 1 to 2 inches (2.5 to 5.0 cm) from your mouth.

- 3 Press the **PTT** button to make the call.
The LED lights up solid green.

- 4 Wait for the Talk Permit Tone to finish (if enabled) and speak clearly into the microphone.

- 5 Release the **PTT** button to listen.
When the target radio responds, the LED blinks green.

- 6 If the Channel Free Indication feature is enabled, you will hear a short alert tone the moment the target radio releases the **PTT** button, indicating the channel is free for you to respond. Press the **PTT** button to respond.
If there is no voice activity for a predetermined period of time, the call ends.

Stopping a Radio Call

This feature allows you to stop an ongoing Group or Private Call to free the channel for transmission. For example, when a radio experiences a “stuck

microphone” condition where the **PTT** button is inadvertently pressed by the user.

Your radio must be programmed to allow you to use this feature.

- 1 Press the programmed **Transmit Interrupt Remote Dekey** button, while on the relevant channel.

- 2 Wait for acknowledgement.

If successful, the radio sounds a positive indicator tone, which indicates that the channel is now free.

If unsuccessful, the radio sounds a negative indicator tone, which indicates that the radio is unable to free the channel.

Note: Your radio sounds a negative indicator tone until you release the PTT button, if it is transmitting an interruptible call that is stopped via this feature.

Talkaround

You can continue to communicate when your repeater is not operating, or when your radio is out of the repeater’s range but within talking range of other radios.

This is called “talkaround”.

Note: This feature is not applicable in Capacity Plus and Linked Capacity Plus.

The Talkaround setting is retained even after powering down.

Press the programmed **Repeater/Talkaround** button.

You hear ...	Indicating ...
Positive Indicator Tone	Radio is in Talkaround mode.
Negative Indicator Tone	Radio is in Repeater mode.

Monitoring Features

Monitoring a Channel

Use the Monitor feature to make sure a channel is clear before transmitting.

This feature is not applicable in Capacity Plus and Linked Capacity Plus.

- 1 Press and hold the programmed **Monitor** button and listen for activity.

The LED double blinks yellow when channel is busy.

- 2 Press the **PTT** button to talk and release it to listen.

Permanent Monitor

Use the Permanent Monitor feature to continuously monitor a selected channel for activity.

Note: This feature is not applicable in Capacity Plus and Linked Capacity Plus.

- 1 Press the programmed **Permanent Monitor** button to activate permanent monitoring of the channel.
Radio sounds an alert tone, the LED lights up solid yellow.
- 2 Press the programmed **Permanent Monitor** button to exit Permanent Monitor mode.
Radio sounds an alert tone, the LED turns off.

Advanced Features in Non-Connect Plus Mode

Scan Lists

Scan lists are created and assigned to individual channels/groups. Your radio scans for voice activity by cycling through the channel/group sequence specified in the scan list for the current channel/group.

Your radio can support up to 250 scan lists, with a maximum of 16 members in a list. Each scan list supports a mixture of both analog and digital entries.

Note: This feature is not applicable in Capacity Plus and Linked Capacity Plus.

Scan

When you start a scan, your radio cycles through the programmed scan list for the current channel looking for voice activity.

The LED blinks yellow and the scan icon appears on the status bar.

During a dual mode scan, if you are on a digital channel, and your radio locks onto an analog channel, it automatically switches from digital mode to analog mode for the duration of the call. This is also true for the reverse.

There are two ways of initiating scan:

- **Main Channel Scan (Manual):** Your radio scans all the channels/groups in your scan list. On entering scan, your radio may – depending on the settings – automatically start on the last scanned “active” channel/group or on the channel where scan was initiated.
- **Auto Scan (Automatic):** Your radio automatically starts scanning when you select a channel/group that has Auto Scan enabled.

Note: This feature is not applicable in Capacity Plus and Linked Capacity Plus.

Starting and Stopping Scan

Do one of the following.

- Press the programmed **Scan** button.
- Use the Channel Selector Knob to select a channel programmed with Auto Scan enabled.

The LED blinks yellow and you hear a positive indicator tone, when Scan is enabled.

The LED turns off and you hear a negative indicator tone, when Scan is disabled.

Responding to a Transmission During a Scan

During scanning, your radio stops on a channel/group where activity is detected. The radio stays on that channel for a programmed time period known as “hang time”.

- 1 Hold the radio vertically 1 to 2 inches (2.5 to 5.0 cm) from your mouth.
 - If the Channel Free Indication feature is enabled, you hear a short alert tone the moment the transmitting radio releases the **PTT** button, indicating the channel is free for you to respond.
 - 2 Press the **PTT** button during hang time. The LED lights up solid green.
 - 3 Wait for one of the following tones to finish (if enabled), and speak clearly into the microphone.
 - The Talk Permit Tone.
 - The **PTT** Sidetone. 
-

- 4 Release the **PTT** button to listen.

If you do not respond within the hang time, the radio returns to scanning other channels/groups.

Deleting a Nuisance Channel

If a channel continually generates unwanted calls or noise (termed a “nuisance” channel), you can temporarily remove the unwanted channel from the scan list.

This capability does not apply to the channel designated as the Selected Channel.

- 1 When your radio “locks on to” an unwanted or nuisance channel, press the programmed **Nuisance Channel Delete** button until you hear a tone.
 - 2 Release the **Nuisance Channel Delete** button. The nuisance channel is deleted.
-

Restoring a Nuisance Channel

To restore the deleted nuisance channel, do one of the following:

- Turn the radio off and then power it on again.

- Change the channel via the **Channel Selector Knob**.

Vote Scan

Vote Scan provides you with wide area coverage in areas where there are multiple base stations transmitting identical information on different analog channels.

Your radio scans analog channels of multiple base stations and performs a voting process to select the strongest received signal. Once that is established, your radio unmutes to transmissions from that base station.

The LED blinks yellow during the Vote Scan operation.

To respond to a transmission during a Vote Scan, follow the same procedures as [Responding to a Transmission During a Scan](#) on page 42.

Call Indicator Settings

Escalating Alarm Tone Volume

You can program your radio to continually alert you when a radio call remains unanswered. This is done

by automatically increasing the alarm tone volume over time. This feature is known as Escalart.

Call Alert Operation

Call Alert paging enables you to alert a specific radio user to call you back when they are able to do so.

This feature is accessible via a programmed **One Touch Access** button.

Receiving and Responding to a Call Alert

When you receive a Call Alert page, you hear a repetitive tone and the LED blinks yellow.

Making a Call Alert with the One Touch Access Button

Press the programmed **One Touch Access** button to make a Call Alert to the predefined alias or ID.

The LED lights up solid green when your radio is sending the Call Alert.

If the Call Alert acknowledgement is received, two chirps sound.

If the Call Alert acknowledgement is not received, a low-pitch tone sounds.

Emergency Operation

An Emergency Alarm is used to indicate a critical situation. You are able to initiate an Emergency at any time, in any state, even when there is activity on the current channel.

Your dealer can set the duration of a button press for the programmed **Emergency** button, except for long press, which is similar with all other buttons:

Short press Between 0.05 seconds and 0.75 seconds.

Long press Between 1.00 second and 3.75 seconds.

The **Emergency** button is assigned with the Emergency On/Off feature. Check with your dealer for the assigned operation of the **Emergency** button.

Note: If the short press for the **Emergency** button is assigned to turn on the Emergency mode, then the long press for the **Emergency** button is assigned to exit the Emergency mode.

If the long press for the **Emergency** button is assigned to turn on the Emergency mode, then the

short press for the **Emergency** button is assigned to exit the Emergency mode.

Your radio supports **three** Emergency Alarms:

- Emergency Alarm.
- Emergency Alarm with Call.
- Emergency Alarm with Voice to Follow. 

Note: Only **ONE** of the Emergency Alarms above can be assigned to the programmed **Emergency** button.

In addition, each alarm has the following types:

- **Regular** – Radio transmits an alarm signal and shows audio and/or visual indicators.
- **Silent** – Radio transmits an alarm signal without any audio or visual indicators. Radio receives calls without any sound through the radio's speaker, until you press the **PTT** button to initiate the call.
- **Silent with Voice** – Radio transmits an alarm signal without any audio or visual indicators, but allow incoming calls to sound through the radio's speaker.

Receiving an Emergency Alarm

When your radio receives an Emergency Alarm, a tone sounds and the LED blinks red until you exit

the Emergency mode. Perform one of the following actions to silence the tone:

- Press the **PTT** button to call the group of radios which received the Emergency Alarm.
- Press any programmable button.
- Exit Emergency mode.

Note: Your radio automatically acknowledges the Emergency Alarm (if enabled).

Exiting Emergency Mode After Receiving the Emergency Alarm

Exit the Emergency mode by performing one of the following actions:

- Changing the channel.
 - Powering down the radio.
 - Pressing the **Emergency Off** button.
 - Pressing the **Emergency On** button. This action clears the alarm indication and initiates an emergency transmission.
-

Sending an Emergency Alarm

This feature allows you to send an Emergency Alarm, a non-voice signal, which triggers an alert indication on a group of radios.

If your radio is set to Silent, it does not display any audio or visual indicators during Emergency mode.

Press the programmed **Emergency On** button.

The LED lights up solid green.

When an Emergency Alarm acknowledgement is received, the Emergency tone sounds and the LED blinks green.

If your radio does not receive an Emergency Alarm acknowledgement, and after all retries have been exhausted, a tone sounds.

Radio exits the Emergency Alarm mode.

Sending an Emergency Alarm with Call

This feature allows you to send an Emergency Alarm to a group of radios. Upon acknowledgement by a radio within the group, the group of radios can communicate over a programmed Emergency channel.

If your radio is set to Silent, it does not display any audio or visual indicators during Emergency mode, or allow any received calls to sound through the radio's speaker, until you press the **PTT** button to initiate the call.

If your radio is set to Silent with Voice, it does not display any audio or visual indicators during Emergency mode, but allow incoming calls to sound through the radio's speaker. The indicators only appear once you press the **PTT** button to initiate, or respond to, the call.

1 Press the programmed **Emergency On** button.

The LED lights up solid green.

When an Emergency Alarm acknowledgement is received, the Emergency tone sounds and the LED blinks green.

2 Hold the radio vertically 1 to 2 inches (2.5 to 5.0 cm) from your mouth.

3 Press **PTT** button to make the call. The LED lights up solid green.

4 Wait for one of the following tones to finish (if enabled), and speak clearly into the microphone.

- The Talk Permit Tone.
- The **PTT** Sidetone. 

5 Release the **PTT** button to listen.

 If the Channel Free Indication feature is enabled, you hear a short alert tone the moment the transmitting radio releases the **PTT** button, indicating the channel is free for you to respond.

6 Press the **PTT** button to respond.

7 Once your call ends, press **Emergency Off** button to exit the Emergency mode.

Sending an Emergency Alarm with Voice to Follow

This feature allows you to send an Emergency Alarm to a group of radios. Your radio's microphone is automatically activated, allowing you to communicate with the group of radios without pressing the **PTT** button.

This activated microphone state is also known as "hot mic".

If your radio has Emergency Cycle Mode enabled, repetitions of hot mic and receiving period are made for a programmed duration. During Emergency Cycle

Mode, received calls sound through the radio's speaker.

If you press the **PTT** button during the programmed receiving period, you hear a prohibit tone, indicating that you should release the **PTT** button. The radio ignores the **PTT** press and remains in Emergency mode.

Note: If you press the **PTT** button during hot mic, and continue to press it after the hot mic duration expires, the radio continues to transmit until you release the **PTT** button.

If your radio is set to Silent, it does not display any audio or visual indicators during Emergency mode, or allow any received calls to sound through the radio's speaker, until the programmed hot mic transmission period is over, and you press the **PTT** button.

If your radio is set to Silent with Voice, it does not display any audio or visual indicators during Emergency mode when you are making the call with hot mic, but allow sound through the radio's speaker when the target radio responds after the programmed hot mic transmission period is over. The indicators only appear when you press the **PTT** button.

Note: If the Emergency Alarm request fails, the radio does not retry to send the request, and enters the hot mic state directly.

- 1 Press the programmed **Emergency On** button. The LED lights up solid green.

- 2 Once a tone sounds, speak clearly into the microphone.
When hot mic has been enabled, the radio automatically transmits without a **PTT** button press until the hot mic duration expires. While transmitting, the LED lights up solid green.

- 3 The radio automatically stops transmitting when the cycling duration between hot mic and receiving calls expires, if Emergency Cycle Mode is enabled.

- 4 Once the hot mic duration expires, the radio automatically stops transmitting. To transmit again, press the **PTT** button.

Reinitializing an Emergency Mode

Note: This feature is only applicable to the radio sending the Emergency Alarm.

There are two instances where this can happen:

- You change the channel while the radio is in Emergency mode. This exits the Emergency mode. If Emergency Alarm is enabled on this new channel, the radio reinitiates Emergency.
- You press the programmed **Emergency On** button during an Emergency initiation/transmission state. This causes the radio to exit this state, and to reinitiate Emergency.

Exiting Emergency Mode After Sending the Emergency Alarm

Your radio exits Emergency mode when one of the following occurs:

- Emergency Alarm acknowledgement is received (for **Emergency Alarm** only).
- All retries to send the alarm have been exhausted.
- The **Emergency Off** button is pressed.

Note: If your radio is powered off, it exits the Emergency mode. The radio will not reinitiate the Emergency mode automatically when it is turned on again.

Text Message Features

Sending a Quick Text Message with the One Touch Access Button

You can send Quick Text messages, programmed by your dealer, via the programmable button.

Press the programmed **One Touch Access** button to send a predefined Quick Text message to a predefined alias or ID.

The LED lights up solid green.

Two chirps indicate that the message is sent.

A low-pitch tone indicates that the message cannot be sent.

Privacy

If enabled, this feature helps to prevent eavesdropping by unauthorized users on a channel by the use of a software-based scrambling solution. The signaling and user identification portions of a transmission are not scrambled.

Your radio must have privacy enabled on the channel to send a privacy-enabled transmission, although this

is not a necessary requirement for receiving a transmission. While on a privacy-enabled channel, the radio is still able to receive clear (unscrambled) transmissions.

Your radio supports two types of privacy:

- Basic Privacy.
- Enhanced Privacy.

Only one of the privacy types above can be assigned to the radio.

To unscramble a privacy-enabled call or data transmission, your radio must be programmed to have the same Privacy Key (for Basic Privacy), or the same Key Value and Key ID (for Enhanced Privacy) as the transmitting radio.

If your radio receives a scrambled call that is of a different Privacy Key, or a different Key Value and Key ID, you will either hear a garbled transmission (Basic Privacy) or nothing at all (Enhanced Privacy).

The LED lights up solid green while the radio is transmitting and blinks green rapidly when the radio is receiving an ongoing privacy-enabled transmission.

You can access this feature by performing one of the following actions:

- Pressing the programmed **Privacy** button to toggle privacy on or off.

Note: Some radio models may not offer this Privacy feature. Check with your dealer or system administrator for more information.

Pressing the programmed **Privacy** button to toggle privacy on or off.

Multi-Site Controls

These features are applicable when your current radio channel is part of an IP Site Connect or Linked Capacity Plus configuration.

See [IP Site Connect](#) on page 28 and [Linked Capacity Plus](#) on page 29 for more details about these configurations.

Starting an Automatic Site Search

Note: The radio **only** scans for a new site if the current signal is weak or when the radio is unable to detect any signal from the current site. If the RSSI value is strong, the radio remains on the current site.

Press the programmed **Site Lock On/Off** button.

If the current channel is a multi-site channel with an attached roam list and is out of range, the radio also performs an automatic site search (site is unlocked) during:

- a **PTT** button press.
- data transmission.

A tone sounds.

The LED blinks yellow rapidly when the radio is actively searching for a new site, and turns off once the radio locks on to a site.

Stopping an Automatic Site Search

When your radio is actively searching for a new site, Press the programmed **Site Lock On/Off** button to stop automatic site search.

A tone sounds and the LED turns off.

Starting a Manual Site Search

Press the programmed **Manual Site Roam** button.

A tone sounds and the LED blinks green.

If a new site is found, a positive indicator tone sounds and the LED turns off.

If there is no available site within range, a negative indicator tone sounds and the LED turns off.

Lone Worker

This feature raises an emergency if there is no user activity, such as any radio button press or activation of the channel selector, for a predefined time.

Before raising the emergency, when the inactivity timer expires, the radio warns the user via an audio indicator.

If there is still no acknowledgement by the user before the predefined reminder timer expires, the radio initiates an Emergency Alarm.

Only one of the following Emergency Alarms can be assigned to this feature:

- Emergency Alarm.
- Emergency Alarm with Call.
- Emergency Alarm with Voice to Follow. 

The radio remains in the emergency state allowing voice messages to proceed until action is taken. See [Emergency Operation](#) on page 44 on ways to exit Emergency.

Note: This feature is limited to radios with this function enabled. Check with your dealer or system administrator for more information.

Password Lock Features

If enabled, this feature only allows you access your radio if the correct password is entered upon powering up. Use the Channel Selector Knob and the three Side Buttons to enter password (see [Radio Controls](#) on page 20).

- Channel Selector Knob positions 1 to 9 represent numbers 1 to 9; position 10 represents the number 0.
- Side Buttons 1 to 3 represent numbers 1 to 3.

Accessing the Radio from Password

- 1 Power up your radio.
You hear a continuous tone.
-
- 2 Use the Channel Selector Knob to enter the first digit of the password.
-
- 3 Press Side Button 1, 2 or 3 to enter each digit of the remaining three digits of the password.

You hear a positive indicator tone for every digit entered. When the second digit of the password is entered, your radio ignores any Channel Selector Knob position change. When the last digit of the four-digit password is entered, your radio automatically checks the validity of the password.

If the password is correct, your radio proceeds to power up. See [Powering Up the Radio](#) on page 18.

If the password is incorrect, you hear a continuous tone. Repeat Steps 2 and 3.

After the third incorrect password, your radio enters into locked state. A tone sounds and the LED double blinks yellow.

Your radio enters into locked state for 15 minutes, and responds to inputs from only.

Note: The radio is unable to receive any call, including emergency calls, in locked state.

Unlocking the Radio from Locked State

- 1 If your radio was powered down after being in the locked state, power up the radio.
A tone sounds and the LED double blinks yellow.

- 2 Wait for 15 minutes.
Your radio restarts the 15 minutes timer for locked state when you power up.
-
- 3 Repeat Steps 1 and 2 in [Accessing the Radio from Password](#) on page 51.
-

Bluetooth Operation

Note: If disabled via the CPS, all Bluetooth-related features are disabled and the Bluetooth device database is erased.

This feature allows you to use your radio with a Bluetooth-enabled device (accessory) via a wireless Bluetooth connection. Your radio supports both Motorola and COTS (Commercially available Off-The-Shelf) Bluetooth-enabled devices.

Bluetooth operates within a range of 10 meters (32 feet) line of sight. This is an unobstructed path between your radio and your Bluetooth-enabled device.

It is not recommended that you leave your radio behind and expect your Bluetooth-enabled device to work with a high degree of reliability when they are separated.

At the fringe areas of reception, both voice and tone quality will start to sound “garbled” or “broken”. To correct this problem, simply position your radio and Bluetooth-enabled device closer to each other (within the 10-meter/32 feet defined range) to re-establish clear audio reception. Your radio’s Bluetooth function has a maximum power of 2.5 mW (4 dBm) at the 10-meter/32 feet range.

Your radio can support up to 3 simultaneous Bluetooth connections with Bluetooth-enabled devices of unique types. For example, a headset, a scanner, and a PTT-Only Device (POD). Multiple connections with Bluetooth-enabled devices of the same type are not supported.

Refer to your respective Bluetooth-enabled device’s user manual for more details on your Bluetooth-enabled device’s full capabilities.

Disconnecting from a Bluetooth Device

On your radio, press the programmed **Bluetooth Disconnect** button.

A positive indicator tone sounds when disconnected.

Switching Audio Route between Internal Radio Speaker and Bluetooth Device

You can toggle audio routing between internal radio speaker and external Bluetooth-enabled accessory.

Press the programmed **Bluetooth Audio Switch** button.

A tone sounds when the audio route has switched.

Permanent Bluetooth Discoverable Mode

Note: The Permanent Bluetooth Discoverable Mode can only be enabled in MOTOTRBO CPS. If enabled, you will **not** be able to use any Bluetooth programmable button features.

Other Bluetooth-enabled devices can locate your radio, but the devices cannot connect to the radio. It enables dedicated devices to use your radio position in the process of Bluetooth-based location.

Auto-Range Transponder System (ARTS)

ARTS is an analog-only feature designed to inform you when your radio is out-of-range of other ARTS-equipped radios.

ARTS-equipped radios transmit or receive signals periodically to confirm that they are within range of each other. Your dealer can program your radio to transmit or receive the ARTS signal.

Your radio provides indications of states as follows:

- **First-Time Alert** – A tone sounds.
- **ARTS-in-Range Alert** – A tone sounds, if programmed.
- **ARTS-Out-of-Range Alert** – A tone sounds, the LED rapidly blinks red.

Over-the-Air-Programming (OTAP)

Your radio can be updated by your dealer remotely, via OTAP, without needing to be physically connected. Additionally, some settings can also be configured via OTAP.

While undergoing OTAP, the LED blinks green.

Note: When the radio is receiving high volume data, the High Volume Data icon appears and channel is busy. A **PTT** button press at this time may cause a negative tone to sound.

Once the programming is complete, a tone sounds, and your radio restarts (powers off and on again).

Utilities

Setting the Power Level

You can customize your radio's power setting to high or low for each channel.

High enables communication with radios located at a considerable distance from you. **Low** enables communication with radios in closer proximity.

Press the programmed **Power Level** button.

Tone heard ...	Radio transmitting at ...
Positive Indicator tone	Low Power
Negative Indicator tone	High Power

Turning the Option Board Feature(s) On or Off

A channel can support up to 6 option board features. Refer to your dealer or system administrator for more information.

Press the programmed **Option Board Feature** button to toggle the feature on or off.

Turning the Voice Operating Transmission (VOX) Feature On or Off

This feature allows you to initiate a hands-free voice activated call on a programmed channel. The radio automatically transmits, for a programmed period, whenever the microphone on the VOX-capable accessory detects voice.

Pressing the **PTT** button during radio operation will disable VOX. To re-enable VOX, do one of the following:

- Turn the radio off and power it on again.
- Change the channel via the Channel Selector Knob.
- Press the programmed **VOX** button to toggle the feature on or off.

If the Talk Permit Tone feature is enabled, use a trigger word to initiate the call. Wait for the Talk Permit Tone to finish before speaking clearly into the microphone.

Note: Turning this feature on or off is limited to radios with this function enabled. Check with your dealer or system administrator for more information.

Turning the Radio Tones/Alerts On or Off

You can enable and disable all radio tones and alerts (except for the incoming Emergency alert tone) if needed.

Press the programmed **All Tones/Alerts** button.

Tone heard ...	Indication
Positive Indicator tone	All tones and alerts are ON .
Negative Indicator tone	All tones and alerts are OFF .

Checking the Battery Strength

You can check how much battery power you have left.

Press the programmed **Battery Strength** button to view the battery strength via the LED indicator.

LED indicator	Indication
Solid Yellow	Radio has a fair battery charge.

LED indicator	Indication
Solid Green	Radio has a full battery charge.

Turning the Voice Announcement On or Off

Note: The Voice Announcement feature can only be enabled in MOTOTRBO CPS. If enabled, the Text-to-Speech feature is automatically disabled, and vice versa.

This feature enables the radio to audibly indicate the current Zone or Channel the user has assigned, or programmable button press. This audio indicator can be customized per customer requirements.

Press the programmed **Voice Announcement** button.

Setting the Text-to-Speech Feature

Note: The Text-to-Speech feature can only be enabled in MOTOTRBO Customer Programming Software. If enabled, the Voice Announcement feature is automatically disabled, and vice versa. Check with your dealer or system administrator for more information.

This feature enables the radio to audibly indicate the content of the most recent received text message. Press the programmed **Text-to-Speech** button to listen to the received text message.

Switching Audio Route between Internal Radio Speaker and Wired Accessory

You can toggle audio routing between the internal radio speaker and the speaker of wired accessory provided that:

- The wired accessory with speaker is attached.
- The audio is not routed to an external Bluetooth-enabled accessory.

Powering down the radio or detaching the accessory resets the audio routing to the internal radio speaker.

Press the programmed **Audio Toggle** button to toggle audio routing between the internal radio speaker and the speaker of wired accessory.

Intelligent Audio

Your radio can automatically adjust its audio volume to overcome background noise in the environment, inclusive of all stationary and non-stationary noise

sources. This feature is a Receive-only feature and does not affect Transmit audio.

Press the programmed **Intelligent Audio** button.

Note: This feature is not applicable during a Bluetooth session.

See [Authorized Accessories List](#) on page 89 for recommended Bluetooth-enabled audio accessories with in-built Automatic Volume Control for similar performance.

Turning the Acoustic Feedback Suppressor Feature On or Off

This feature allows you to minimize acoustic feedback in received calls.

Press the programmed **Acoustic Feedback Suppressor** button.

You hear a positive indicator tone, indicating that Acoustic Feedback Suppressor is now enabled.

You hear a negative indicator tone, indicating that the radio is unable to activate Acoustic Feedback Suppressor.

Turning Trill Enhancement On or Off

You can enable this feature when you are speaking in a language that contains many words with alveolar trill (rolling “R”) pronunciations. Press the programmed **Trill Enhancement On/Off** button to toggle trill enhancement on or off.

Turning the Global Positioning System (GPS) On or Off

GPS is a satellite navigation system that determines the radio’s precise location.

Press the programmed **GPS** button to toggle the feature on or off.

Flexible Receive List

Flexible Receive List is a digital-only (currently supported in Capacity Plus and Linked Capacity Plus) feature that allows you to create and assign members on the receive talkgroup list. Your radio can support a maximum of 16 members in the list.

Turning the Flexible Receive List On or Off

You can enable and disable the Flexible Receive List if needed.

Press the programmed **Flexible Receive List** button.

The LED blinks yellow and you hear a positive indicator tone, when Flexible Receive List is enabled.

The LED turns off and you hear a negative indicator tone, when Flexible Receive List is disabled.



Connect Plus Operations

Additional Radio Controls in Connect Plus Mode

Push-To-Talk (PTT) Button

The **PTT** button on the side of the radio (A) serves two basic purposes:

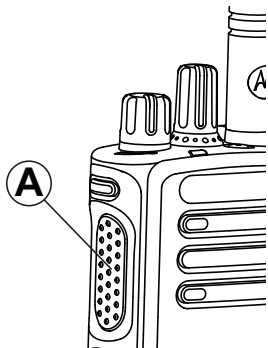

- While a call is in progress, the **PTT** button allows the radio to transmit to other radios in the call.

Press and hold down **PTT** button to talk. Release the **PTT** button to listen.

The microphone is activated when the **PTT** button is pressed.

- While a call is not in progress, the **PTT** button is used to make a new call (see [Making a Radio Call](#) on page 69).

If the Talk Permit Tone is enabled, wait until the short alert tone ends before talking.

Programmable Buttons

Your dealer can program the programmable buttons as shortcuts to **radio functions** depending on the duration of a button press:

- Short press – Pressing and releasing rapidly.
- Long press – Pressing and holding for the programmed duration.
- Hold down – Keeping the button pressed.

Note: The programmed duration of a button press is applicable for all assignable radio/utility functions or settings. See [Emergency Operation](#) on page 76 for more information on the programmed duration of the **Emergency** button.

Assignable Radio Functions

Beacon On/Off	Toggles the Beacon feature on or off. Requires purchase of Connect Plus Man Down feature.
Beacon Reset	Resets (cancels) the Beacon tone, but it does not turn the Beacon feature off. Requires purchase of Connect Plus Man Down feature.
Bluetooth® Audio Switch	Toggles audio routing between internal radio speaker and external Bluetooth-enabled accessory.
Bluetooth Connect	Initiates a Bluetooth find-and-connect operation.
Bluetooth Disconnect	Terminates all existing Bluetooth connections between your radio and any Bluetooth-enabled devices.
Bluetooth Discoverable	Enables your radio to enter Bluetooth Discoverable Mode.

Busy Queue Cancellation

Exits the busy mode when a non-Emergency call in the Busy Queue was initiated. Emergency calls, once accepted into the Busy Queue, cannot be cancelled.

Emergency On/Off

Depending on the programming, initiates or cancels an emergency.

Intelligent Audio

Toggles intelligent audio on or off.

Man Down Alarms On/Off

Toggles all configured Man Down Alarms on or off. Requires purchase of Connect Plus Man Down feature.

Man Down Alarms Reset

If pressed while a Man Down feature Alert Tone is playing, the tone is cancelled and feature timers are reset, but it does not turn the Man Down Alarms off. Requires purchase of Man Down feature.

Mic AGC On/Off	Toggles the internal microphone automatic gain control (AGC) on or off.
One Touch Access	Directly initiates a predefined Private Call, a Call Alert or a Quick Text message.
Phone Exit 	Ends a Phone Call.
Privacy	Toggles privacy on or off.
Roam Request	Requests to search for a different site.
Scan	Toggles scan on or off.
Site Lock On/Off	When toggled on, the radio searches the current site only. When toggled off, the radio searches other sites in addition to the current site.
Voice Announcement for Channel	Plays zone and channel announcement voice messages for the current channel. This function is unavailable when Voice Announcement is disabled.

Voice Announcement On/Off	Toggles voice announcement on or off.
Zone Toggle	Allows radio user to toggle between Zone 1 and Zone 2.

Assignable Settings or Utility Functions

AF Suppressor	Toggles the Acoustic Feedback Suppressor feature on or off.
All Tones/Alerts	Toggles all tones and alerts on or off.
Battery Strength	Indicates battery strength via the LED Indicator.
Global Positioning System (GPS)	Toggles the satellite navigation system on or off.
Mic Distortion	Toggles the Microphone Dynamic Distortion Control feature on or off.
Power Level	Toggles transmit power level between high and low.

Unassigned Indicates that the button function has not yet been assigned.

Identifying Status Indicators in Connect Plus Mode

LED Indicator

The LED indicator (A) shows the operational status of your radio.

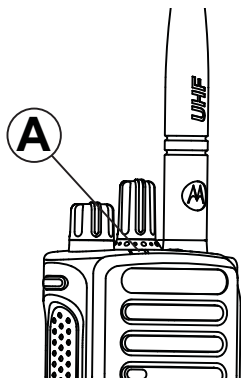



Blinking red Radio is transmitting at low battery condition, receiving an emergency

	transmission or has failed the self-test upon powering up, or has moved out of range if radio is configured with Auto-Range Transponder System.
Rapidly blinking red	Radio is receiving over-the-air file transfer (Option Board firmware file, Network Frequency file or Option Board Codeplug file) or upgrading to a new Option Board firmware file.
Blinking green and yellow	Radio is receiving a Call Alert, received a text message or Scan is enabled and is receiving activity.
Solid yellow	Radio is in Bluetooth Discoverable Mode. Also indicates fair battery charge when programmable button is pressed.
Double blinking yellow	Radio is actively searching for a new site.
Blinking yellow	Radio is receiving a Call Alert or Scan is enabled and is idle (radio will remain muted to any activity).

Solid green	Radio is powering up or transmitting. Also indicates full charge of the battery when the programmed Battery Strength button is pressed.
Blinking green	Radio is powering up, receiving a non-privacy-enabled call or data.
Double blinking green	Radio is receiving a privacy-enabled call.





Indicator Tones

High pitched tone	<input type="checkbox"/>	Low pitched tone	<input checked="" type="checkbox"/>
-------------------	--------------------------	------------------	-------------------------------------

	Positive Indicator Tone
	Negative Indicator Tone

Audio Tones

Audio tones provide you with audible indications of the status, or response to data received on the radio.

Continuous Tone 	A monotone sound. Sounds continuously until termination.
Periodic Tone 	Sounds periodically depending on the duration set by the radio. Tone starts, stops, and repeats itself.
Repetitive Tone 	A single tone that repeats itself until it is terminated by the user.
Momentary Tone 	Sounds only once for a short period of time defined by the radio.

Switching Between Connect Plus and Non-Connect Plus Modes

To switch to a non-Connect Plus mode, you must change to another zone, if programmed by your dealer or system administrator. Check with your dealer or system administrator to see if your radio has been programmed with non-Connect Plus zones, and

what features are available while operating in non-Connect Plus zones.

Making and Receiving Calls in Connect Plus Mode

Selecting a Site

A site provides coverage for a specific area. A Connect Plus site has a site controller and a maximum of 15 repeaters. In a multi-site network, the Connect Plus radio will automatically search for a new site when the signal level from the current site drops to an unacceptable level.

Roam Request

A Roam Request tells the radio to search for a different site, even if the signal from the current site is acceptable.

If there are no sites available,

- The radio continues to search through the list of sites.
- The radio will return to the previous site, if the previous site is still available.

Note: This is programmed by your dealer.

Press the programmed **Roam Request** button. You hear a tone, indicating the radio has switched to a new site.

Site Lock On/Off

When toggled on, the radio searches the current site only. When toggled off, the radio searches other sites in addition to the current site.

Press the programmed **Site Lock** button.

- You hear a positive indicator tone, indicating the radio has locked to the current site.
 - You hear a negative indicator tone, indicating the radio is unlocked.
-

Selecting a Zone

The radio can be programmed with a maximum of 16 Connect Plus Zones and each Connect Plus zone contains a maximum of 16 assignable positions on the Channel Selector Knob.

Each assignable knob position can be used to start one of the following voice call types:

- Group Call

- Multigroup Call
- Site All Call
- Private Call

Access the Zone feature by performing one of the following actions: Press the programmed **Zone** button.

Using Multiple Networks

If your radio has been programmed to use multiple Connect Plus networks, you can select a different network by switching to the Connect Plus zone that is assigned to the desired network. These network-to-zone assignments are configured by your dealer through radio programming.

Selecting a Call Type

Use the Channel Selector Knob to select a call type. This can be a Group Call, Multi-group Call, Site All Call or Private Call, depending on how your radio is programmed. If you change the Channel Selector Knob to a different position (that has a call type assigned to it), this causes the radio to re-register with the Connect Plus site. The radio registers with

the Registration Group ID that has been programmed for the new Channel Selector Knob position call type.

If you select a position that has no call type assigned to it, your radio sounds a continuous tone. Your radio does not operate when selected to an unprogrammed channel, use the Channel Selector Knob to select a programmed channel instead.

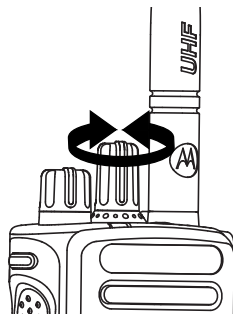

Once the required zone is set (if you have multiple zones in your radio), turn the programmed Channel Selector Knob to select the call type.

Receiving and Responding to a Radio Call

Once the channel, subscriber ID or call type is set, you can proceed to receive and respond to calls.

The LED lights up solid green while the radio is transmitting and blinks green when the radio is receiving.

Note: The LED lights up solid green while the radio is transmitting and double blinks green when the radio is receiving a privacy-enabled call. To unscramble a privacy-enabled call, your radio must have the same Privacy Key, OR the same Key Value and Key ID (programmed by your dealer), as the transmitting radio (the radio you are receiving the call from).

Note: See [Privacy](#) on page 83 for more information.

Receiving and Responding to a Group Call

To receive a call from a group of users, your radio must be configured as part of that group.

The LED blinks green. Your radio unmutes and the incoming call sounds through the radio's speaker.

- 1 Hold the radio vertically 1 to 2 inches (2.5 to 5.0 cm) from your mouth.
The LED lights up solid green.

- 2 Wait for one of the Talk Permit Tone to finish (if enabled), and speak clearly into the microphone.

- 3 Release the **PTT** button to listen.

If there is no voice activity for a predetermined period of time, the call ends.

Note: See [Making a Group Call](#) on page 69 for details on making a Group Call.

Receiving and Responding to a Private Call

A Private Call is a call from an individual radio to another individual radio.

When you receive a Private Call, the LED blinks green. Your radio unmutes and the incoming call sounds through the radio's speaker.

- 1 Hold the radio vertically 1 to 2 inches (2.5 to 5.0 cm) from your mouth.

- 2 Press the **PTT** button to respond to the call.
The LED lights up solid green.

- 3 Wait for the Talk Permit Tone to finish (if enabled), and speak clearly into the microphone.

- 4 Release the **PTT** button to listen.

If there is no voice activity for a predetermined period of time, the call ends.

You hear a short tone.

See [Making a Private Call](#) on page 69 for details on making a Private Call.

Receiving a Site All Call

A Site All Call is a call from an individual radio to every radio on the site. It is used to make important announcements requiring the user's full attention.

When you receive an Site All Call, a tone sounds and the LED blinks green.

Your radio unmutes and the incoming call sounds through the radio speaker.

A Site All Call does not wait for a predetermined period of time before ending.

You cannot respond to an Site All Call.

Note: The radio stops receiving the Site All Call if you switch to a different channel while receiving the call. During a Site All Call, you will **not** be able to use any programmed button functions until the call ends.

Receiving an Inbound Private Phone Call

When you receive an Inbound Private Phone Call, the LED blinks green. The radio unmutes and the incoming private phone call sounds through the radio's speaker.

- 1 Press and hold down **PTT** button to answer and talk. Release the **PTT** button to listen.

- 2 Press preprogrammed **Phone Exit** button to end the call.
A short feedback tone sounds.

Receiving an Inbound Phone Talkgroup Call

When you receive an Inbound Phone Talkgroup Call, the LED blinks green. The radio unmutes and the incoming group call sounds through the radio's speaker.

Press the **PTT** button to talk and release it to listen.

Inbound Phone Multi-Group Call

When you receive an Inbound Phone Multi-Group Call, the LED blinks green. The radio unmutes and

the incoming multi-group call sounds through the radio's speaker.

Making a Radio Call

After selecting your channel, you can select a subscriber alias or ID, or group alias or ID by using:

- The Channel Selector Knob.
- A programmed **One Touch Access** button – The One Touch Access feature allows you to make a Private Call to a predefined ID easily. This feature can be assigned to a short or long programmable button press. You can **ONLY** have one ID assigned to a **One Touch Access** button. Your radio can have multiple **One Touch Access** buttons programmed.

Note: Your radio must have the Privacy feature enabled on the channel to send a privacy-enabled transmission. Only target radios with the same Key Value and Key ID as your radio will be able to unscramble the transmission.

Note: See [Privacy](#) on page 83 for more information.

Making a Call

Making a Group Call

To make a call to a group of users, your radio must be configured as part of that group.

- 1 Select the channel with the active group alias or ID. See [Selecting a Call Type](#) on page 66.
- 2 Hold the radio vertically 1 to 2 inches (2.5 to 5.0 cm) from your mouth.
- 3 Press the **PTT** button to make the call. The LED lights up solid green.
- 4 Wait for the Talk Permit Tone to finish (if enabled), and speak clearly into the microphone.
- 5 Release the **PTT** button to listen.
When the target radio responds, the LED blinks green.
If there is no voice activity for a predetermined period of time, the call ends.

Making a Private Call

While you can receive and/or respond to a Private Call initiated by an authorized individual radio, your

radio must be programmed for you to initiate a Private Call.

You will hear a negative indicator tone, when you make a Private Call via the **One Touch Access** button, if this feature is not enabled.

Use the Quick Text Message or Call Alert features to contact an individual radio. See [Text Message Features](#) on page 83 or [Call Alert Operation](#) on page 43 for more information.

- 1 Do one of the following.
 - Select the channel with the active subscriber alias or ID. See [Selecting a Call Type](#) on page 66.
 - Press the programmed **One Touch Access** button.

-
- 2 Hold the radio vertically 1 to 2 inches (2.5 to 5.0 cm) from your mouth.

-
- 3 Press the **PTT** button to make the call. The LED lights up solid green.

-
- 4 Wait for the Talk Permit Tone to finish (if enabled), and speak clearly into the microphone.
-

- 5 Release the **PTT** button to listen.

When the target radio responds, the LED blinks green.

If there is no voice activity for a predetermined period of time, the call ends. You hear a short tone.

Making a Site All Call

This feature allows you to transmit to all users on the site that are currently not engaged in another call. Your radio must be programmed to allow you to use this feature.

Users on the channel/site cannot respond to an Site All Call.

- 1 Select the channel with the active Site All Call group alias. See [Selecting a Call Type](#) on page 66.

-
- 2 Hold the radio vertically 1 to 2 inches (2.5 to 5.0 cm) from your mouth.

-
- 3 Press the **PTT** button to make the call. The LED lights up solid green.
-

- 4 Wait for the Talk Permit Tone to finish (if enabled), and speak clearly into the microphone.
-

Making a Multi-group Call

This feature allows you to transmit to all users on multiple groups. Your radio must be programmed to allow you to use this feature.

Note: Users on the groups cannot respond to a Multi-group Call.

- 1 Turn the Channel Selector Knob to select the Multi-group alias or ID.
-
- 2 Press the **PTT** button to make the call.
The LED lights up solid green.
Wait for the Talk Permit Tone to finish (if enabled) and speak clearly into the microphone.
-

Making a Private Call with a One Touch Call Button

The One Touch Call feature allows you to easily make a Private Call to a pre-defined Private Call alias or ID. This feature can be assigned to a short or long programmable button press.

You can **ONLY** have one alias or ID assigned to a One Touch Call button. Your radio can have multiple One Touch Call buttons programmed.

- 1 Press the programmed **One Touch Call** button to make a Private Call to the pre-defined Private Call alias or ID.
-
- 2 Hold the radio vertically 1 to 2 inches (2.5 to 5.0 cm) from your mouth.
-
- 3 Press the **PTT** button to make the call.
The LED lights up solid green.
-
- 4 Wait for the Talk Permit Tone to finish (if enabled) and speak clearly into the microphone.
-
- 5 Release the **PTT** button to listen.
When the target radio responds, the LED blinks green.
If there is no voice activity for a predetermined period of time, the call ends.
-

Advanced Features in Connect Plus Mode

Auto Fallback

Auto Fallback is a system feature that allows you to continue to make and receive non-emergency calls on the selected Group Contact in the event of certain types of Connect Plus system failures.

If one of these failures occurs, your radio attempts to roam to a different Connect Plus site. This search process may result in your radio finding an operable Connect Plus site, or it may result in your radio finding a “Fallback Channel” (if your radio is enabled for Auto Fallback). A Fallback Channel is a repeater that is normally part of an operable Connect Plus site, but is currently unable to communicate with either its site controller or the Connect Plus network. In Fallback mode, the repeater operates as a single digital repeater. Auto Fallback Mode supports non-emergency Group Calls only. No other call types are supported in Fallback Mode.

Indications of Auto Fallback Mode

When your radio is using a Fallback channel, you hear the intermittent “Fallback Tone” approximately once every 15 seconds (except while transmitting). Your radio only permits PTT on the selected Group Contact (Group Call, Multigroup Call, or Site All Call). It does not allow you to make other types of calls.

Making/Receiving Calls in Fallback Mode

Note: Calls are heard only by radios that are monitoring the same Fallback channel and selected to the same Group. Calls are not networked to other sites or other repeaters.

Emergency voice calls or Emergency Alerts are not available in Fallback mode. If you press the emergency button in Fallback mode, the radio provides an invalid key press tone.

Private (radio to radio) and Phone calls are not available in Fallback mode. If you attempt a call to a private contact, you will receive a denial tone. At this point you should select a desired group contact. Other non-supported calls include Remote Monitor, Call Alert, Radio Check, Radio Enable, Radio Disable, Text messaging, Location Updates, and packet data calls.

Enhanced Traffic Channel Access (ETCA) is not supported in Auto Fallback mode. If two or more radio users press **PTT** at the same time (or at almost the same time), it is possible that both radios transmit until **PTT** is released. In this event, it is possible that none of the transmissions will be understood by receiving radios.

Making calls in Fallback mode is similar to normal functioning. Simply select the group contact you wish to use (using the radio's normal channel selection method), and then press the **PTT** to start your call. It is possible that the channel may be in use already by another group. If the channel is in use, you receive a busy tone. You may select Group, Multi-group or Site All Call contacts using your radio's normal channel selection method. While the radio is operating on the Fallback Channel, the Multigroup operates just like other Groups. It is only heard by radios that are currently selected to the same Multi-group.

Returning to Normal Operation

If the site returns to normal trunking operation while you are in range of your Fallback repeater, your radio automatically exits Auto Fallback mode. You hear a registration "beep" when the radio successfully registers. If you are in the range of an operable site

(that is not in Fallback mode), you may press the Roam Request button (if programmed for your radio) to force your radio to search for and register on an available site. If no other site is available, your radio returns to Auto Fallback mode after searching is complete. If you drive out of coverage of your Fallback repeater, your radio enters Search mode.

Scan

This feature allows your radio to monitor and join calls for groups defined in a pre-programmed scan list. When scan is enabled, the scan icon appears on the status bar and the LED blinks yellow when idle.

Starting and Stopping Scan

Note: This procedure turns the Scan feature On or Off for all Connect Plus zones with the same Network ID as your currently selected zone.

You can start and stop scanning by pressing the programmed **Scan** button.

- A tone sounds indicating that Scan has been turned on or off.
- When Scan is enabled, the tone's pitch increases.
- When Scan is disabled, the tone's pitch decreases.

Responding to a Transmission During a Scan

During scanning, your radio stops on a group where activity is detected. The radio continuously listens for any member in the scan list when idle on the control channel.

- 1 Hold the radio vertically 1 to 2 inches (2.5 to 5.0 cm) from your mouth.

- 2 Press the **PTT** button during hang time. The LED lights up solid green.

- 3 Wait for the Talk Permit Tone to finish (if enabled), and speak clearly into the microphone.

- 4 Release the **PTT** button to listen.
If you do not respond within the hang time, the radio returns to scanning other groups.

Turning Scan On or Off

Note: This procedure turns the Scan feature On or Off for all zones with the same Network ID as your currently selected zone.

When Scan is on and you are not participating in a call, the LED blinks green and yellow.

The procedure for turning Scan on or off depends on how your radio is programmed. If programmed with a Scan On/Off button, use the button to toggle the feature on or off.

- A tone sounds indicating that Scan has been turned on or off.
- When Scan is enabled, the tone's pitch increases.
- When Scan is disabled, the tone's pitch decreases.

Understanding Scan Operation

Note: If you scan into a call for a group that is not assigned to a channel position in the currently selected zone and you miss the call's Hang Time, switch to the proper zone and then select the group's channel position to talk back to that group.

There are some circumstances in which you can miss calls for groups that are in your scan list. When you miss a call for one of the following reasons, this does not indicate a problem with your radio. This is a normal scan operation for Connect Plus.

- Scan feature is not turned on (check for LED blinking yellow).
- You are participating in a call already.

- No member of the scanned group is registered at your site (Multisite systems only).

Scan Talkback

If your radio scans into a call from the selectable group scan list, and if the **PTT** button is pressed during the scanned call, the operation of the radio depends on whether Scan Talkback was enabled or disabled during radio programming. For more information on how your radio is programmed, contact your radio dealer (or your radio system administrator).

Scan Talkback Disabled

The radio leaves the scanned call and attempts to transmit on the contact for the currently selected channel position. After the Call Hang Time on the currently selected contact expires, the radio returns to the home channel and starts the Scan Hang Time Timer. The radio resumes group scan after its Scan Hang Time Timer expires.

Scan Talkback Enabled

If the **PTT** button is pressed during the Group Hang Time of the scanned call,

the radio attempts to transmit to the scanned group.

Note: If you scan into a call for a group that is not assigned to a channel position in the currently selected zone and you miss the Hang Time of the call, switch to the proper zone and then select the channel position of the group to talk back to that group.

Call Indicator Settings

Escalating Alarm Tone Volume

You can program your radio to continually alert you when a radio call remains unanswered. This is done by automatically increasing the alarm tone volume over time. This feature is known as Escalart.

Call Alert Operation

Call Alert paging enables you to alert a specific radio user to call you back when they are able to do so.

This feature is accessible via a programmed **One Touch Access** button.

Receiving and Responding to a Call Alert

When you receive a Call Alert page, you hear a repetitive tone and the LED blinks yellow.

Making a Call Alert with the One Touch Access Button

Press the programmed **One Touch Access** button to make a Call Alert to the predefined alias.

The LED lights up solid green when your radio is sending the Call Alert.

If the Call Alert acknowledgement is received, a positive indicator tone sounds.

If the Call Alert acknowledgement is not received, a negative indicator tone sounds.

Emergency Operation

Note: If your radio is programmed for “Silent” or “Silent with voice” emergency initiation, in most cases it automatically exits silent operation after the Emergency Call or Emergency Alert is finished. The exception to this rule is when “Emergency Alert” is the configured Emergency Mode and “Silent” is the configured Emergency Type. If your radio is programmed in this manner, the silent operation

continues until you cancel silent operation by pressing PTT or the button configured for “Emergency Off”.

Emergency voice calls and Emergency Alerts are not supported when operating in Connect Plus Auto Fallback mode. For more information see the [Auto Fallback](#) on page 72.

An Emergency Alert is used to indicate a critical situation. You can initiate an Emergency at any time, in any state, even when there is activity on the current channel. Pressing the **Emergency** button initiates the programmed Emergency mode. The programmed Emergency mode may also be initiated by triggering the optional Man Down feature. The Emergency feature may be disabled in your radio.

Your dealer can set the duration of a button press for the programmed Emergency button, except for long press, which is similar with all other buttons:

Short press Between 0.05 seconds and 0.75 seconds.

Long press Between 1.00 second and 3.75 seconds.

The Emergency button is assigned with the Emergency On/Off feature. Check with your dealer for the assigned operation of the Emergency button.

- If the short press for the **Emergency** button is assigned to turn on the Emergency mode, then the long press for the **Emergency** button is assigned to exit the Emergency mode.
- If the long press for the **Emergency** button is assigned to turn on the Emergency mode, then the short press for the **Emergency** button is assigned to exit the Emergency mode.

When your radio is selected to a Connect Plus zone, it supports three Emergency modes:

- **Emergency Call** – You must press the **PTT** button to talk on the assigned emergency time slot.
- **Emergency Call with Voice to Follow** – For the first transmission on the assigned emergency time slot, the microphone is automatically unmuted and you may talk without pressing the **PTT** button. The microphone stays “hot” in this fashion for a time period programmed into the radio. For subsequent transmissions in the same Emergency call, you must press the **PTT** button.
- **Emergency Alert** – An Emergency Alert is not a voice call. It is an emergency notification that is

sent to radios that are configured to receive these alerts. The radio sends an emergency alert via the control channel of the currently registered site. The Emergency Alert is received by radios in the Connect Plus network that are programmed to receive them (no matter which network site they are registered to).

Only ONE of the Emergency Modes can be assigned to the Emergency button per zone. In addition, each Emergency mode has the following types:

- Regular – Radio initiates an Emergency and shows audio and/or visual indicators.
- Silent – Radio initiates an Emergency without any audio or visual indicators. The radio will suppress all audio or visual indications of the Emergency until you press the **PTT** button to start a voice transmission.
- Silent with Voice – The same as Silent operation, except that the radio will also unmute for some voice transmissions.

Responding to an Emergency Call

The radio does not show that it is receiving an Emergency call. Respond the same way as you would to group calls.

Initiating an Emergency Call

Note: If your radio is set to Silent, it does not display any audio or visual indicators during Emergency mode until you press the **PTT** button to initiate a voice transmission.

If your radio is set to Silent with Voice, it does not initially display any audio or visual indicators that the radio is in Emergency mode. However, your radio unmutes for the transmissions of radios responding to your emergency. The emergency indicators only appear once you press the **PTT** button to initiate a voice transmission from your radio.

For both “Silent” and “Silent with Voice” operation, the radio automatically exits silent operation after the Emergency Call is finished.

1 Press the programmed **Emergency** button.

2 Hold the radio vertically 1 to 2 inches (2.5 to 5.0 cm) from your mouth.

3 Press the **PTT** button to initiate a voice transmission on the Emergency group.

When you release the **PTT** button, the Emergency call continues for the time allotted for the Emergency Call Hang Time.

If you press the **PTT** button during this time, the Emergency call continues.

Initiating an Emergency Call with Voice to Follow

Your radio must be programmed for this type of operation.

When enabled for this operation, when you press the programmed **Emergency** button, and when your radio receives the time slot assignment, the microphone is automatically activated without pressing the **PTT** button. This activated microphone state is also known as “hot mic”. The “hot mic” applies to the first voice transmission from your radio during the Emergency call. For subsequent transmissions in the same Emergency call, you must press the **PTT** button.

1 Press the programmed **Emergency** button.

2 Hold the radio vertically 1 to 2 inches (2.5 to 5.0 cm) from your mouth.

- 3 The microphone remains active for the “hot mic” time specified in your radio's codeplug programming.
During this time, the LED lights up green.

- 4 Press and hold the **PTT** button to talk longer than the programmed duration.

Initiating an Emergency Alert

Note: If your radio is programmed for “Silent” or “Silent with Voice”, it will not provide any audio or visual indications that it is sending an Emergency Alert. If programmed for “Silent”, the silent operation continues indefinitely until you press PTT or the button configured for “Emergency Off”. If programmed for “Silent with Voice”, the radio automatically cancels silent operation when the site controller broadcasts the Emergency Alert.

Press the orange **Emergency** button.

Once the Emergency Alert is successfully sent and is being broadcast for other radios to hear, a positive indicator tone is played.

Exiting Emergency Mode

Note: If the Emergency call ends due to the expiration of the Emergency Hang Time, but the emergency condition is not over, press the **Emergency** button again to restart the process.

If you initiate an Emergency Alert by pressing the programmed **Emergency** button, your radio automatically exits Emergency mode after receiving a response from the Connect Plus system.

If you initiate an Emergency call by pressing the programmed **Emergency** button, your radio will be assigned a channel automatically when one becomes available. Once your radio has transmitted a message indicating the emergency, you cannot cancel your Emergency call. However, if you pressed the button by accident or the emergency no longer exists, you may wish to say this over the assigned channel. When you release the **PTT** button, the Emergency call is discontinued after the Emergency Call Hang Time expires.

If your radio was configured for Emergency with Voice to Follow, use the “hot mic” period to explain your error, then press and release the **PTT** button to discontinue the transmission. The Emergency call is

discontinued after the Emergency Call Hang Time expires.

Man Down Alarms

Note: Man Down Alarms are not supported when operating in Fallback mode. For more information see the [Auto Fallback](#) on page 72.

This section describes the Connect Plus Man Down Feature. This is a purchasable feature that may or may not apply to your radio.

Your Connect Plus portable radio can be enabled and programmed for one or more of the Man Down Alarms. Your dealer or radio system administrator can tell you whether or not this applies to your radio and which specific Man Down Alarms have been enabled and programmed.

If your radio has been programmed for one or more of the following Man Down Alarms, it is important for you to understand how the Alarm works, what indication (tones) your radio provides, and the action you should take.

The purpose of the Man Down Alarms is to alert others when you might be in danger. This is accomplished by programming your radio to detect a

certain angle of tilt, lack of movement, or movement, depending on which Man Down Alarm(s) is/are enabled. If your radio detects a disallowed movement type, and if the condition is not corrected in a certain period of time, the radio starts to play an Alert Tone (if so programmed). At this point you should immediately take one or more of the corrective actions discussed below, depending on which Man Down Alarm(s) has/have been enabled for your radio. If you do not take corrective action within a certain period of time, your radio automatically starts an Emergency (either an Emergency Call or Emergency Alert).

- **Tilt Alarm** – When your radio is tilted at or beyond a specified angle for a period of time, it plays an Alert Tone (if so programmed). To prevent the radio from automatically starting an Emergency Call or Emergency Alert, restore the radio to the vertical position immediately.
- **Anti-Movement Alarm** – When your radio is motionless for a period of time, it plays an Alert Tone (if so programmed). To prevent the radio from automatically starting an Emergency Call or Emergency Alert, move the radio immediately.
- **Movement Alarm** – When your radio is in motion for a period of time, it plays an Alert Tone (if so programmed). To prevent the radio from

automatically starting an Emergency Call or Emergency Alert, stop the radio's motion immediately.

Your dealer or radio system administrator can tell you which of the above alarms (if any) has been enabled through radio programming. It is possible to enable both the Tilt and Anti-Movement Alarms. In that case, the Alert Tone plays when the radio detects the first movement violation.

Instead of taking the corrective actions discussed above, you can also prevent the radio from starting the Emergency call or Emergency Alert by using a programmable button, if your radio has been configured in this manner. This is discussed in the next two sections.

Turning Man Down Alarms On and Off

The procedure for turning the Man Down Alarms On and Off depends on how your radio is programmed. If programmed with a Man Down Alarms On/Off button, use the button to toggle the Man Down Alarms On and Off. This applies to all of the Man Down Alarms enabled for your radio.

When using the programmable button to toggle the Man Down Alarms On, your radio plays a tone that rises in pitch.

When using the programmable button to toggle the Man Down Alarms Off, your radio plays a tone that falls in pitch.

In order to hear the tones described above when turning the Man Down Alarms On and Off, the MOTOTRBO radio and Connect Plus Option Board must both be enabled for keypad tones.

Resetting the Man Down Alarms

If your radio has been programmed with either a Man Down Alarms Reset button, or the Man Down Alarms menu option, it is possible to reset the Man Down Alarms without turning them On or Off. This stops any Man Down Alert Tone that is currently playing, and it also resets the Alarm timers. However, it is still necessary to correct the movement violation by taking the appropriate corrective action described in the Man Down Alarms section. If the movement violation is not corrected within a period of time, the Alert Tone starts playing again.

Beacon Feature

This section describes the Beacon feature. The Beacon feature is part of Connect Plus Man Down, a purchasable feature. Your dealer or Radio System Administrator can tell you if the Beacon feature applies to your radio.

If your radio has been enabled and programmed for one or more of the Man Down Alarms, it can also be enabled for the Beacon feature.

If your radio automatically starts an Emergency Call or Emergency Alert due to one of the Man Down Alarms, and if your radio is also enabled for the Beacon feature, the radio starts to periodically emit a high pitched tone approximately once every ten seconds. The interval can vary depending on whether you are talking on your radio. The purpose of the Beacon tone is to help searchers locate you. If your radio has also been enabled for the “Visual Beacon”, the radio’s backlight comes on for a few seconds every time the Beacon tone plays.

You can stop your radio from playing the Beacon tone by using a programmable button, if your radio has been configured in this manner. This is discussed in the next two sections. If your radio does not have the

programmable button or menu option, you can stop the Beacon tone by turning the radio off and then on again, or by changing to a different zone (if your radio has been programmed for more than one zone).

Turning Beacon On and Off

The procedure for turning the Beacon On and Off depends on how your radio is programmed. If programmed with a Beacon On/Off button, use the button to toggle the Beacon On and Off.

- When using the programmable button to toggle the Beacon On, your radio plays a tone that rises in pitch.
- When using the programmable button to toggle the Beacon Off, your radio plays a tone that falls in pitch.

In order to hear the tones described above when turning the Beacon On and Off, the MOTOTRBO radio and Connect Plus Option Board must both be enabled for keypad tones.

Resetting the Beacon

If your radio has been programmed with either the Beacon Reset button, it is possible to reset the

Beacon. This stops the Beacon Tone without turning the Beacon feature Off.

Text Message Features

Sending a Quick Text Message with the One Touch Access Button

Press the programmed **One Touch Access** button to send a predefined Quick Text message to a predefined alias.
The green LED lights up.

If the message is sent, a tone sounds.

If the message cannot be sent, a low tone sounds.

Privacy

If enabled, this feature helps to prevent eavesdropping by unauthorized users on a channel by the use of a software-based scrambling solution. The signaling and user identification portions of a transmission are not scrambled.

Your radio must have privacy enabled on the current channel selector position to send a privacy-enabled transmission, although this is not a necessary requirement for receiving a transmission. While on a

privacy-enabled channel selector position, the radio is still able to receive clear (unscrambled) transmissions.

Your radio supports Enhanced Privacy.

To unscramble a privacy-enabled call transmission, your radio must be programmed to have the same Key Value and Key ID (for Enhanced Privacy) as the transmitting radio.

If your radio receives a scrambled call that is of a different Key Value and Key ID, you hear nothing at all (Enhanced Privacy).

The LED lights up solid green while the radio is transmitting and blinks green rapidly when the radio is receiving an ongoing privacy-enabled transmission.

You can access this feature by performing one of the following actions:

- Pressing the programmed **Privacy** button to toggle privacy on or off.

Note: Some radio models may not offer this Privacy feature. Check with your dealer or system administrator for more information.

Making a Privacy-Enabled (Scrambled) Call

Toggle privacy on using the programmed privacy button. Your radio must have the Privacy feature enabled for the currently selected channel position to send a privacy-enabled transmission. When privacy is enabled for the currently selected channel position, all voice transmissions made by your radio will be scrambled. This includes Group Call, Multigroup Call, talk-back during scanned calls, Site All Call, Emergency Call, and Private Call. Only receiving radios with the same Key Value and Key ID as your radio will be able to unscramble the transmission.

Bluetooth Operation

Note: If disabled via the CPS, all Bluetooth-related features are disabled and the Bluetooth device database is erased.

This feature allows you to use your radio with a Bluetooth-enabled device (accessory) via a wireless Bluetooth connection. Your radio supports both Motorola and COTS (Commercially available Off-The-Shelf) Bluetooth-enabled devices.

Bluetooth operates within a range of 10 meters (32 feet) line of sight. This is an unobstructed path

between your radio and your Bluetooth-enabled device.

It is not recommended that you leave your radio behind and expect your Bluetooth-enabled device to work with a high degree of reliability when they are separated.

At the fringe areas of reception, both voice and tone quality will start to sound “garbled” or “broken”. To correct this problem, simply position your radio and Bluetooth-enabled device closer to each other (within the 10-meter/32 feet defined range) to re-establish clear audio reception. Your radio’s Bluetooth function has a maximum power of 2.5 mW (4 dBm) at the 10-meter/32 feet range.

Your radio can support up to 4 simultaneous Bluetooth connections with Bluetooth-enabled devices of unique types. For example, a headset, and a PTT-Only Device (POD). Multiple connections with Bluetooth-enabled devices of the same type are not supported.

Refer to your respective Bluetooth-enabled device’s user manual for more details on your Bluetooth-enabled device’s full capabilities.

Finding and Connecting to a Bluetooth Device

Do not turn off your Bluetooth-enabled device during the finding and connecting operation as this cancels the operation.

The radio connects to the Bluetooth-enabled device within range with either the strongest signal strength, or to one which it has connected to before in a prior session.

1 Turn on your Bluetooth-enabled device and place it in pairing mode. Refer to respective Bluetooth-enabled device's user manual.

2 On your radio, press the programmed **Bluetooth Connect** button.
A tone sounds and LED blinks yellow.

3 Your Bluetooth-enabled device may require additional steps to complete the pairing. Refer to respective Bluetooth-enabled device's user manual.

If successful, a positive indicator tone sounds.

If unsuccessful, a negative indicator tone sounds.

Note: A pin code may be required to be programmed in your radio before it can pair with some devices. Contact your dealer for more information.

Disconnecting from a Bluetooth Device

On your radio, press the programmed **Bluetooth Disconnect** button.

A positive indicator tone sounds when disconnected.

Switching Audio Route between Internal Radio Speaker and Bluetooth Device

You can toggle audio routing between internal radio speaker and external Bluetooth-enabled accessory.

Press the programmed **Bluetooth Audio Switch** button.

A tone sounds when the audio route has switched.

Permanent Bluetooth Discoverable Mode

Note: The Permanent Bluetooth Discoverable Mode can only be enabled in MOTOTRBO CPS. If enabled, you will **not** be able to use any Bluetooth programmable button features.

Other Bluetooth-enabled devices can locate your radio, but the devices cannot connect to the radio. It enables dedicated devices to use your radio position in the process of Bluetooth-based location.

Utilities

Turning the Radio Tones/Alerts On or Off

You can enable and disable all radio tones and alerts (except for the incoming Emergency alert tone) if needed.

Press the programmed **All Tones/Alerts** button.

Tone heard ...	Indication
Positive Indicator tone	All tones and alerts are ON .
Negative Indicator tone	All tones and alerts are OFF .

Setting the Power Level

You can customize your radio's power setting to high or low for each Connect Plus zone.

High enables communication with tower sites in Connect Plus mode located at a considerable distance from you. **Low** enables communication with tower sites in Connect Plus mode in closer proximity.

Press the programmed **Power Level** button.

Tone heard ...	Radio transmitting at ...
Positive Indicator tone	Low Power
Negative Indicator tone	High Power

Voice Announcement

This feature enables the radio to audibly indicate the current Zone or Channel the user has just assigned, or programmable button press. This audio indicator can be customized per customer requirements.

Press the programmed **Voice Announcement** button.

Checking the Battery Strength

You can check how much battery power you have left.

Press the programmed **Battery Strength** button to view the battery strength via the LED indicator.

LED indicator	Indication
Solid Yellow	Radio has a fair battery charge.
Solid Green	Radio has a full battery charge.

Intelligent Audio

Your radio can automatically adjust its audio volume to overcome background noise in the environment, inclusive of all stationary and non-stationary noise sources. This feature is a Receive-only feature and does not affect Transmit audio.

Press the programmed **Intelligent Audio** button.

Note: This feature is not applicable during a Bluetooth session.

See [Authorized Accessories List](#) on page 89 for recommended Bluetooth-enabled audio accessories with in-built Automatic Volume Control for similar performance.

Turning the Acoustic Feedback Suppressor Feature On or Off

This feature allows you to minimize acoustic feedback in received calls.

Press the programmed **Acoustic Feedback Suppressor** button.

You hear a positive indicator tone, indicating that Acoustic Feedback Suppressor is now enabled.

You hear a negative indicator tone, indicating that the radio is unable to activate Acoustic Feedback Suppressor.

Turning the Global Positioning System (GPS) On or Off

GPS is a satellite navigation system that determines the radio's precise location.

Press the programmed **GPS** button to toggle the feature on or off.



Accessories

Authorized Accessories List

Antennas

- UHF, 403 – 527MHz, Whip Antenna (PMAE4068_)^[3]
- UHF, 403 – 527MHz, Slim Whip Antenna (PMAE4079_)^[3]
- UHF, 403 – 450MHz, Stubby Antenna (PMAE4069_)^[3]
- UHF, 440 – 490MHz, Stubby Antenna (PMAE4070_)^[3]
- UHF, 470 – 527MHz, Stubby Antenna (PMAE4071_)^[3]
- UHF, 470 – 527MHz, Stubby Antenna (PMAE4071_)^[3]
- VHF, 144 – 165MHz, Helical Antenna (PMAD4116_)^[3]
- VHF, 136 – 155MHz, Helical Antenna (PMAD4117_)^[3]
- VHF, 152 – 174MHz, Helical Antenna (PMAD4118_)^[3]

- VHF, 136 – 148MHz, Stubby Antenna (PMAD4119_)^[3]
- VHF, 146 – 160MHz, Stubby Antenna (PMAD4120_)^[3]
- VHF, 160 – 174MHz, Stubby Antenna (PMAD4121_)^[3]
- 800/900, 806 – 870MHz, Whip Antenna (PMAF4011_)^[4]
- 800/900, 896 – 941MHz, Whip Antenna (PMAF4012_)^[4]
- 800/900, 806 – 870MHz, Short Whip Antenna (PMAF4009_)
- 800/900, 896 – 941MHz, Short Whip Antenna (PMAF4010_)

Batteries

- Core NiMH, 1300 mAh Battery (PMNN4412_)^[5]
- Core Slim Li-Ion, 1500 mAh Battery (PMNN4406_R)

³ Applicable to XPR7350 only.

⁴ Applicable to XPR7380 only.

- IMPRES Li-Ion, 1500 mAh Slim Battery (PMNN4407_R)
- IMPRES Hi-Capacity Li-Ion, 2150 mAh Battery (PMNN4409_R)
- IMPRES Hi-Capacity Li-Ion, 2300 mAh Battery (FM) (NNTN8129_)
- IMPRES Li-Ion, 2700 mAh Battery (PMNN4448_R)

Carry Devices

- 2.5-Inch Replacement Leather Swivel Belt Loop (PMLN5610_)
- 3-Inch Replacement Leather Swivel Belt Loop (PMLN5611_)
- Hard Leather Carry Case with 3-Inch Fixed Belt Loop for Non-Display Radio (PMLN5839_)
- Hard Leather Carry Case with 3-Inch Swivel Belt Loop for Non-Display Radio (PMLN5846_)
- Hard Leather Carry Case with 2.5-Inch Swivel Belt Loop for Non-Display Radio (PMLN5843_)

- Nylon Carry Case with 3-Inch Fixed Belt Loop for Non-Display Radio (PMLN5845_)
- Belt Clip for 2-Inch Belt Width (PMLN4651_)
- Belt Clip for 2.5-Inch Belt Width (PMLN7008_)

Chargers

- IMPRES Multi-Unit Charger (WPLN4212_)
- IMPRES Multi-Unit Charger with Display (WPLN4219_)
- IMPRES Single-Unit Charger (WPLN4232_)
- Core Single Unit Charger (NNTN8117_)
- IMPRES Vehicular Charger (NNTN7616_)
- IMPRES Battery Reader (NNTN7392_)

Earbuds and Earpieces

- Receive-Only Earbud (AARLN4885_)
- Receive-Only Earbud (MDRLN4885)
- D-Shell Receive-Only Earpiece (PMLN4620_)
- Receive-Only Earpiece (RLN4941_)
- Standard Earpiece, Black (RLN6279_)
- Standard Earpiece, Beige (RLN6280_)

- Earpiece with Acoustic Tube Assembly, Beige (RLN6284_)
- Earpiece with Acoustic Tube Assembly, Black (RLN6285_)
- Earpiece with High Noise Kit, Beige (RLN6288_)
- Earpiece with High Noise Kit, Black (RLN6289_)
- 1-Wire Earbud, 29cm Cord, Black (NNTN8294_)
- 1-Wire Earbud, 116cm Cord, Black (NNTN8295_)
- Over-the-Ear Receiver for Remote Speaker Microphone (WADN4190_)
- D-Shell Earset (PMLN5096_)
- IMPRES Temple Transducer with In-line Push-to-Talk (PMLN5101_)
- Replacement Foam Ear Pad and Windscreen (RLN6283_)
- Replacement Ear Seal Cloth Cover (1580376E32)
- Replacement Boom Mic Windscreen (5080548E02)
- Replacement Windscreen O-Ring (3280376E35)
- Wireless Earpiece Maintenance Kit (NTN8821_)
- Replacement Ear Tips Kit for Wireless Ear Buds (NNTN8316_)
- Replacement Ear Tubes for CommPort Earpiece, Pack of 10 (RLN5037_)

- Ear Straps for CommPort Earpiece (for Secure Attachment to Ear), Pack of 10 (NTN8988_)

Headsets and Headset Accessories

- Ultra-Lite Headset (PMLN5102_)
- Heavy Duty Noise-Canceling Headset (PMLN5275_)
- Lightweight Headset (RMN5058_)
- Non-Secure Wireless Headset & Push-to-Talk Device with Push-to-Talk Audio, 12-Inch Cable (NNTN8125_)
- Non-Secure Wireless Headset & Push-to-Talk Device with Push-to-Talk Audio, 9.5-Inch Cable (NNTN8126_)
- Non-Secure Wireless Push-to-Talk Device (NNTN8127_)
- Push-to-Talk Module, without Charger (NNTN8191_)
- Replacement Earpiece 12-Inch Cable (for NNTN8125_)(NTN2572_)
- Business Wireless Accessory Kit (PMLN6463_)

Remote Speaker Microphones

- Remote Speaker Microphone (PMMN4024_)

- IMPRES Remote Speaker Microphone (PMMN4025_)
- Remote Speaker Microphone, Submersible (IP57) (PMMN4040_)
- IMPRES Remote Speaker Microphone, with Volume, IP57 (PMMN4046_)
- IMPRES Remote Speaker Microphone, with Earjack, Noise-Canceling (PMMN4050_)
- Remote Speaker Microphone Replacement Coil Cord Kit (For Use with PMMN4024_ and PMMN4040_) (RLN6074_)
- Remote Speaker Microphone Replacement Coil Cord Kit (For Use with PMMN4025_, PMMN4046_, PMMN4050_) (RLN6075_)
- IMPRES Remote Speaker Microphone, IP57 (NNTN8382_)
- IMPRES Remote Speaker Microphone, with Earjack (NNTN8383_)
- Surveillance High Noise Kit (RLN5887_)
- IMPRES 2-Wire Surveillance Kit, Black (PMLN6127_)
- IMPRES 2-Wire Surveillance Kit, Beige (PMLN6128_)
- IMPRES 2-Wire Surveillance Kit with Clear, Comfortable Acoustic Tube, Black (RLN5882_)
- IMPRES 2-Wire Surveillance Kit with Clear, Comfortable Acoustic Tube, Black (PMLN6129_)
- IMPRES 2-Wire Surveillance Kit with Clear, Comfortable Acoustic Tube, Beige (PMLN6130_)
- IMPRES 3-Wire Surveillance, Black (PMLN5097_)
- IMPRES 3-Wire Surveillance, Beige (PMLN5106_)
- IMPRES 3-Wire Surveillance with Clear, Comfortable Acoustic Tube, Black (PMLN6123_)
- IMPRES 3-Wire Surveillance with Clear, Comfortable Acoustic Tube, Beige (PMLN6124_)
- Transparent Acoustic Tube (RLN6242_)
- Replacement Foam Plugs, Pack of 50 (For Use with RLN5886_) (RLN6281_)
- Replacement Ear Tips, Clear, Pack of 50 (For Use with RLN5887_) (RLN6282_)
- Small Custom Earpiece for Surveillance Kits, Right Ear (RLN4760_)

Surveillance Accessories

- Receive Only Surveillance Kit, Black (Single Wire) (PMLN6125_)
- Receive Only Surveillance Kit, Beige (Single Wire) (PMLN6126_)
- Surveillance Low Noise Kit (RLN5886_)

- Medium Custom Earpiece for Surveillance Kits, Right Ear (RLN4761_)
- Large Custom Earpiece for Surveillance Kits, Right Ear (RLN4762_)
- Small Custom Earpiece for Surveillance Kits, Left Ear (RLN4763_)
- Medium Custom Earpiece for Surveillance Kits, Left Ear (RLN4764_)
- Large Custom Earpiece for Surveillance Kits, Left Ear (RLN4765_)
- Belt (4200865599)

Miscellaneous Accessories

- Universal Chest Pack (HLN6602_)
- Waterproof Bag, Includes Large Carry Strap (HLN9985_)
- Shoulder Strap (Attaches to D-Ring on Carry Case) (NTN5243_)
- Small Clip, Epaulet Strap (RLN4295_)
- Break-A-Way Chest Pack (RLN4570_)
- Universal RadioPAK and Utility Case (Fanny Pack) (RLN4815_)
- Replacement Strap for RLN4570_ and HLN6602_ Chest Packs (1505596Z02)
- Universal RadioPAK Extension Belt (4280384F89)

Maritime Radio Use in the VHF Frequency Range

Special Channel Assignments

Emergency Channel

If you are in imminent and grave danger at sea and require emergency assistance, use VHF Channel 16 to send a distress call to nearby vessels and the United States Coast Guard. Transmit the following information, in this order:

- 1 “MAYDAY, MAYDAY, MAYDAY.”
- 2 “THIS IS _____, CALL SIGN _____.” State the name of the vessel in distress 3 times, followed by the call sign or other identification of the vessel, stated 3 times.
- 3 Repeat “MAYDAY” and the name of the vessel.
- 4 “WE ARE LOCATED AT _____.” State the position of the vessel in distress, using any information that will help responders to locate you, e.g.:
 - latitude and longitude
 - bearing (state whether you are using true or magnetic north)

- distance to a well-known landmark
 - vessel course, speed or destination
- 5 State the nature of the distress.
 - 6 Specify what kind of assistance you need.
 - 7 State the number of persons on board and the number needing medical attention, if any.
 - 8 Mention any other information that would be helpful to responders, such as type of vessel, vessel length and/or tonnage, hull color, etc.
 - 9 “OVER.”
 - 10 Wait for a response.
 - 11 If you do not receive an immediate response, remain by the radio and repeat the transmission at intervals until you receive a response. Be prepared to follow any instructions given to you.

Non-Commercial Call Channel

For non-commercial transmissions, such as fishing reports, rendezvous arrangements, repair scheduling, or berthing information, use **VHF Channel 9**.

Operating Frequency Requirements

A radio designated for shipboard use must comply with Federal Communications Commission Rule Part 80 as follows:

- on ships subject to Part II of Title III of the Communications Act, the radio must be capable of operating on the 156.800 MHz frequency.
- on ships subject to the Safety Convention, the radio must be capable of operating:
 - in the simplex mode on the ship station transmitting frequencies specified in the 156.025 – 157.425 MHz frequency band, and
 - in the semiduplex mode on the two frequency channels specified in the table below.

Note:

Simplex channels 3, 21, 23, 61, 64, 81, 82, and 83 cannot be lawfully used by the general public in US waters.

Additional information about operating requirements in the Maritime Services can be obtained from the full text of FCC Rule Part 80 and from the US Coast Guard.

Table 1: VHF Marine Channel List

Channel Number	Frequency (MHz)	
	Transmit	Receive

1	156.050	160.550
2	156.100	160.700
*	156.150	160.750
4	156.200	160.800
5	156.250	160.850
6	156.300	–
7	156.350	160.950
8	156.400	–
9	156.450	156.450
10	156.500	156.500
11	156.550	156.550
12	156.600	156.600
13**	156.650	156.650
14	156.700	156.700
15**	156.750	156.750
16	156.800	156.800
17**	156.850	156.850

18	156.900	161.500
19	156.950	161.550
20	157.000	161.600
*	157.050	161.650
22	157.100	161.700
*	157.150	161.750
24	157.200	161.800
25	157.250	161.850
26	157.300	161.950
27	157.350	161.950
28	157.400	162.000
60	156.025	160.625
*	156.075	160.675
62	156.125	160.725
63	156.175	160.775
*	156.225	160.825
65	156.275	160.875

66	156.325	160.925
67**	156.375	156.375
68	156.425	156.425
69	156.475	156.475
71	156.575	156.575
72	156.625	–
73	156.675	156.675
74	156.725	156.725
75	***	***
76	***	***
77**	156.875	–
78	156.925	161.525
79	156.975	161.575
80	157.025	161.025
*	157.025	161.675
*	157.125	161.725
*	157.175	161.775

84	157.225	161.825
85	157.275	161.875
86	157.325	161.925
87	157.375	161.975
88	157.425	162.025

Note:

* *Simplex channels 3, 21, 23, 61, 64, 81, 82, and 83 cannot be **lawfully used** by the general public in US waters.*

** *Low power (1 W) only.*

*** *Guard band.*

Note: A – in the Receive column indicates that the channel is transmit only.

Declaration of Compliance for the Use of Distress and Safety Frequencies

The radio equipment does not employ a modulation other than the internationally adopted modulation for maritime use when it operates on the distress and safety frequencies specified in RSS-182 Section 7.3.

Technical Parameters for Interfacing External Data Sources

	RS232	USB	SB9600
Input Voltage (Volts Peak-to-peak)	18V	3.6V	5V
Max Data Rate	28 kb/s	12 Mb/s	9.6 kb/s
Impedance	5k ohm	90 ohm	120 ohm

Batteries and Chargers Warranty

The Workmanship Warranty

The workmanship warranty guarantees against defects in workmanship under normal use and service.

All MOTOTRBO Batteries	24 Months
IMPRES Chargers (Single-Unit and Multi-Unit, Non-Display)	24 Months
IMPRES Chargers (Multi-Unit with Display)	12 Months

The Capacity Warranty

The capacity warranty guarantees 80% of the rated capacity for the warranty duration.

Nickel Metal-Hydride (NiMH) or Lithium-Ion (Li-Ion) Batteries	12 Months
---	-----------

IMPRES Batteries, When Used Exclusively with IMPRES Chargers	18 Months
--	-----------

Limited Warranty

MOTOROLA COMMUNICATION PRODUCTS

I. WHAT THIS WARRANTY COVERS AND FOR HOW LONG:

MOTOROLA SOLUTIONS, INC. (“MOTOROLA”) warrants the MOTOROLA manufactured Communication Products listed below (“Product”) against defects in material and workmanship under normal use and service for a period of time from the date of purchase as scheduled below:

XPR Series Digital Portable Radios	24 Months
Product Accessories (Excluding Batteries and Chargers)	12 Months

MOTOROLA, at its option, will at no charge either repair the Product (with new or reconditioned parts), replace it (with a new or reconditioned Product), or refund the purchase price of the Product during the warranty period provided it is returned in accordance

with the terms of this warranty. Replaced parts or boards are warranted for the balance of the original applicable warranty period. All replaced parts of Product shall become the property of MOTOROLA.

This express limited warranty is extended by MOTOROLA to the original end user purchaser only and is not assignable or transferable to any other party. This is the complete warranty for the Product manufactured by MOTOROLA. MOTOROLA assumes no obligations or liability for additions or modifications to this warranty unless made in writing and signed by an officer of MOTOROLA.

Unless made in a separate agreement between MOTOROLA and the original end user purchaser, MOTOROLA does not warrant the installation, maintenance or service of the Product.

MOTOROLA cannot be responsible in any way for any ancillary equipment not furnished by MOTOROLA which is attached to or used in connection with the Product, or for operation of the Product with any ancillary equipment, and all such equipment is expressly excluded from this warranty. Because each system which may use the Product is unique, MOTOROLA disclaims liability for range, coverage, or

operation of the system as a whole under this warranty.

II. GENERAL PROVISIONS:

This warranty sets forth the full extent of MOTOROLA'S responsibilities regarding the Product. Repair, replacement or refund of the purchase price, at MOTOROLA's option, is the exclusive remedy. THIS WARRANTY IS GIVEN IN LIEU OF ALL OTHER EXPRESS WARRANTIES. IMPLIED WARRANTIES, INCLUDING WITHOUT LIMITATION, IMPLIED WARRANTIES OF MERCHANTABILITY AND FITNESS FOR A PARTICULAR PURPOSE, ARE LIMITED TO THE DURATION OF THIS LIMITED WARRANTY. IN NO EVENT SHALL MOTOROLA BE LIABLE FOR DAMAGES IN EXCESS OF THE PURCHASE PRICE OF THE PRODUCT, FOR ANY LOSS OF USE, LOSS OF TIME, INCONVENIENCE, COMMERCIAL LOSS, LOST PROFITS OR SAVINGS OR OTHER INCIDENTAL, SPECIAL OR CONSEQUENTIAL DAMAGES ARISING OUT OF THE USE OR INABILITY TO USE SUCH PRODUCT, TO THE FULL EXTENT SUCH MAY BE DISCLAIMED BY LAW.

III. STATE LAW RIGHTS:

SOME STATES DO NOT ALLOW THE EXCLUSION OR LIMITATION OF INCIDENTAL OR CONSEQUENTIAL DAMAGES OR LIMITATION ON HOW LONG AN IMPLIED WARRANTY LASTS, SO THE ABOVE LIMITATION OR EXCLUSIONS MAY NOT APPLY.

This warranty gives specific legal rights, and there may be other rights which may vary from state to state.

IV. HOW TO GET WARRANTY SERVICE:

You must provide proof of purchase (bearing the date of purchase and Product item serial number) in order to receive warranty service and, also, deliver or send the Product item, transportation and insurance prepaid, to an authorized warranty service location. Warranty service will be provided by MOTOROLA through one of its authorized warranty service locations. If you first contact the company which sold you the Product (e.g., dealer or communication service provider), it can facilitate your obtaining warranty service. You can also call MOTOROLA at 1-800-927-2744 US/Canada.

V. WHAT THIS WARRANTY DOES NOT COVER:

- 1 Defects or damage resulting from use of the Product in other than its normal and customary manner.
- 2 Defects or damage from misuse, accident, water, or neglect.
- 3 Defects or damage from improper testing, operation, maintenance, installation, alteration, modification, or adjustment.
- 4 Breakage or damage to antennas unless caused directly by defects in material workmanship.
- 5 A Product subjected to unauthorized Product modifications, disassembles or repairs (including, without limitation, the addition to the Product of non-MOTOROLA supplied equipment) which adversely affect performance of the Product or interfere with MOTOROLA's normal warranty inspection and testing of the Product to verify any warranty claim.
- 6 Product which has had the serial number removed or made illegible.
- 7 Rechargeable batteries if:
 - any of the seals on the battery enclosure of cells are broken or show evidence of tampering.
 - the damage or defect is caused by charging or using the battery in equipment or service other than the Product for which it is specified.
- 8 Freight costs to the repair depot.
- 9 A Product which, due to illegal or unauthorized alteration of the software/firmware in the Product, does not function in accordance with MOTOROLA's published specifications or the FCC certification labeling in effect for the Product at the time the Product was initially distributed from MOTOROLA.
- 10 Scratches or other cosmetic damage to Product surfaces that does not affect the operation of the Product.
- 11 Normal and customary wear and tear.

VI. PATENT AND SOFTWARE PROVISIONS:

MOTOROLA will defend, at its own expense, any suit brought against the end user purchaser to the extent that it is based on a claim that the Product or parts infringe a United States patent, and MOTOROLA will pay those costs and damages finally awarded against

the end user purchaser in any such suit which are attributable to any such claim, but such defense and payments are conditioned on the following:

- 1 that MOTOROLA will be notified promptly in writing by such purchaser of any notice of such claim,
- 2 that MOTOROLA will have sole control of the defense of such suit and all negotiations for its settlement or compromise, and
- 3 should the Product or parts become, or in MOTOROLA's opinion be likely to become, the subject of a claim of infringement of a United States patent, that such purchaser will permit MOTOROLA, at its option and expense, either to procure for such purchaser the right to continue using the Product or parts or to replace or modify the same so that it becomes non-infringing or to grant such purchaser a credit for the Product or parts as depreciated and accept its return. The depreciation will be an equal amount per year over the lifetime of the Product or parts as established by MOTOROLA.

MOTOROLA will have no liability with respect to any claim of patent infringement which is based upon the combination of the Product or parts furnished

hereunder with software, apparatus or devices not furnished by MOTOROLA, nor will MOTOROLA have any liability for the use of ancillary equipment or software not furnished by MOTOROLA which is attached to or used in connection with the Product. The foregoing states the entire liability of MOTOROLA with respect to infringement of patents by the Product or any parts thereof.

Laws in the United States and other countries preserve for MOTOROLA certain exclusive rights for copyrighted MOTOROLA software such as the exclusive rights to reproduce in copies and distribute copies of such MOTOROLA software. MOTOROLA software may be used in only the Product in which the software was originally embodied and such software in such Product may not be replaced, copied, distributed, modified in any way, or used to produce any derivative thereof. No other use including, without limitation, alteration, modification, reproduction, distribution, or reverse engineering of such MOTOROLA software or exercise of rights in such MOTOROLA software is permitted. No license is granted by implication, estoppel or otherwise under MOTOROLA patent rights or copyrights.

VII. GOVERNING LAW:

This Warranty is governed by the laws of the State of Illinois, U.S.A.



MOTOROLA

Recommended Dealer:
www.hkrsolutions.com

HKRSolutions

Two-way Radio & Accessories Specialist

Motorola Solutions, Inc.
1303 East Algonquin Road
Schaumburg, Illinois 60196 U.S.A.

MOTOROLA, MOTO, MOTOROLA SOLUTIONS and the Stylized M logo are trademarks or registered trademarks of Motorola Trademark Holdings, LLC and are used under license. All other trademarks are the property of their respective owners.

© 2012 – 2014 Motorola Solutions, Inc. All rights reserved.

October 2014

www.motorolasolutions.com/mototrbo



68009500001-GA