



PROFESSIONAL DIGITAL TWO-WAY RADIO

MOTOTRBO™

DEP 570

LIMITED KEYPAD PORTABLE



USER GUIDE





Contents

Declaration of Conformity.....	6	Preparing Your Radio for Use.....	13
Important Safety Information.....	8	Charging the Battery.....	13
Software Version.....	9	Attaching the Battery.....	13
Computer Software Copyrights....	10	Attaching the Antenna.....	14
Handling Precautions.....	11	Attaching the Belt Clip.....	14
Getting Started.....	12	Attaching the Universal Connector Cover (Dust Cover).....	15
How to Use This Guide.....	12	Attaching the Accessory Connector.....	16
What Your Dealer/System Administrator Can Tell You.....	12	Powering Up the Radio.....	16
		Adjusting the Volume.....	17
		Identifying Radio Controls.....	18
		Radio Controls.....	18
		Additional Radio Controls.....	19
		Push-To-Talk (PTT) Button.....	19
		Programmable Buttons.....	19
		Assignable Radio Functions.....	20
		Assignable Settings or Utility Functions.....	21
		Accessing the Programmed Functions.....	21
		Identifying Status Indicators.....	22

Display Icons.....	22
Call Icons.....	24
Advanced Menu Icons.....	24
Mini Notice Icons.....	25
Sent Item Icons 	25
LED Indicator.....	26
Audio Tones.....	27
Indicator Tones.....	27
Switching Between Conventional Analog and Digital Mode.....	27







Making and Receiving Calls.....29



Selecting a Zone.....	29
Selecting a Channel.....	29
Receiving and Responding to a Radio Call... 30	
Receiving and Responding to a Group Call.....	30
Receiving and Responding to a Private Call 	31
Receiving an All Call.....	32
Receiving and Responding to a Selective Call 	32
Receiving and Responding to a Phone Call 	33
Making a Radio Call.....	34

Making a Group Call.....	35
Making a Private Call 	35
Making an All Call.....	36
Making a Selective Call 	37
Making a Phone Call with the One Touch Access Button.....	38
Making a Phone Call with the Programmable Phone Button 	39
Stopping a Radio Call 	40
Talkaround.....	41
Monitoring Features.....	41
Monitoring a Channel.....	41
Permanent Monitor.....	42

Advanced Features.....43

Radio Check.....	43
Sending a Radio Check.....	43
Scan Lists.....	43
Viewing an Entry in the Scan List.....	44
Editing the Scan List.....	44
Scan.....	46
Starting and Stopping Scan.....	46
Responding to a Transmission During a Scan.....	47
Deleting a Nuisance Channel.....	47

Restoring a Nuisance Channel.....	47	Making a Call Alert from the	
Vote Scan 	48	Contact List.....	56
Contact Settings.....	48	Making a Call Alert with the One	
Making a Group Call from Contacts....	49	Touch Access Button.....	57
Making a Private Call from		Emergency Operation.....	57
Contacts 	50	Sending an Emergency Alarm.....	58
Setting a Default Contact 	50	Sending an Emergency Alarm with	
Call Indicator Settings.....	51	Call.....	58
Activating and Deactivating Call		Sending an Emergency Alarm with	
Ringers for Call Alert 	51	Voice to Follow 	60
Activating and Deactivating Call		Reinitiating an Emergency Mode.....	61
Ringers for Private Calls 	51	Exiting Emergency Mode.....	61
Activating and Deactivating Call		Text Message Features.....	61
Ringers for Selective Call 	52	Sending a Quick Text Message.....	61
Activating and Deactivating Call		Sending a Quick Text Message	
Ringers for Text Message.....	53	with the One Touch Access	
Assigning Ring Styles.....	53	Button.....	62
Escalating Alarm Tone Volume.....	54	Managing Fail-to-Send Text	
Call Log Features.....	54	Messages.....	62
Viewing Recent Calls.....	54	Managing Sent Text Messages.....	63
Deleting a Call from a Call List.....	55	Receiving a Text Message.....	66
Viewing Details from a Call List.....	55	Managing Received Text Messages...	67
Call Alert Operation.....	56	Analog Message Encode	69
Receiving and Responding to a		Sending MDC Message Encode to	
Call Alert.....	56	Dispatcher.....	69

Sending 5–Tone Message Encode to Contact.....	69	Setting the Power Level.....	81
Analog Status Update 	70	Adjusting the Display Brightness.....	81
Sending Status Update to Predefined Contact.....	70	Turning the Voice Operating Transmission (VOX) Feature On or Off.....	82
Viewing a 5-Tone Status Details.....	70	Turning the Radio Tones/Alerts On or Off.....	83
Privacy.....	71	Turning the Power Up Alert Tone On or Off.....	84
Security.....	72	Setting the Tone Alert Volume Offset Level.....	84
Radio Disable.....	72	Turning the Talk Permit Tone On or Off.....	85
Radio Enable.....	74	Language.....	86
Lone Worker.....	75	Turning the LED Indicator On or Off...	86
Password Lock Features.....	76	Turning the Introduction Screen On or Off.....	87
Accessing the Radio from Password.....	76	Voice Announcement.....	87
Unlocking the Radio from Locked State.....	76	Call Forwarding 	88
Turning the Password Lock On or Off.....	77	Menu Timer.....	89
Changing the Password.....	77	Analog Mic AGC (Mic AGC-A).....	89
Notification List.....	78	Digital Mic AGC (Mic AGC-D).....	90
Accessing the Notification List.....	79	Intelligent Audio.....	91
Auto-Range Transponder System (ARTS) 	79	Turning the Acoustic Feedback Suppressor Feature On or Off.....	92
Over-the-Air-Programming (OTAP).....	79		
Utilities.....	80		
Setting the Squelch Level.....	80		

Accessing General Radio
 Information..... 92
 RSSI Values..... 95
 Front Panel Programming (FPP)..... 95

Accessories..... 96

Antennas..... 96
 Batteries..... 96
 Carry Devices..... 97
 Chargers..... 97
 Earbuds and Earpieces..... 98
 Headsets and Headset Accessories..... 98
 Remote Speaker Microphones..... 98
 Surveillance Accessories..... 98
 Miscellaneous Accessories..... 98

Batteries and Chargers Warranty..... 100

The Workmanship Warranty..... 100
 The Capacity Warranty..... 100

Limited Warranty..... 101

MOTOROLA COMMUNICATION
 PRODUCTS..... 101
 I. WHAT THIS WARRANTY COVERS
 AND FOR HOW LONG:..... 101
 II. GENERAL PROVISIONS:..... 102
 III. STATE LAW RIGHTS:..... 102

IV. HOW TO GET WARRANTY SERVICE:.. 102
 V. WHAT THIS WARRANTY DOES NOT
 COVER:..... 103
 VI. PATENT AND SOFTWARE
 PROVISIONS:..... 103
 VII. GOVERNING LAW:..... 105

Declaration of Conformity

This declaration is applicable to your radio only if your radio is labeled with the FCC logo shown below.

Declaration of Conformity
Per FCC CFR 47 Part 2 Section 2.1077(a)

Responsible Party
Name: Motorola Solutions, Inc.
Address: 1303 East Algonquin Road, Schaumburg, IL 60196-1078, U.S.A.
Phone Number: 1-800-927-2744
Hereby declares that the product:
Model Name: DEP 570
conforms to the following regulations:
FCC Part 15, subpart B, section 15.107(a), 15.107(d) and section 15.109(a)

Class B Digital Device

As a personal computer peripheral, this device complies with Part 15 of the FCC Rules. Operation is subject to the following two conditions:

- 1 This device may not cause harmful interference, and
- 2 This device must accept any interference received, including interference that may cause undesired operation.

Note:

This equipment has been tested and found to comply with the limits for a Class B digital device, pursuant to part 15 of the FCC Rules. These limits are designed to provide reasonable protection against harmful interference in a residential installation. This equipment generates, uses and can radiate radio frequency energy and, if not installed and used in accordance with the instructions, may cause harmful interference to radio communications. However, there is no guarantee that interference will not occur in a particular installation.

If this equipment does cause harmful interference to radio or television reception, which can be determined by turning the equipment off and on, the user is encouraged to try to correct the interference by one or more of the following measures:

- Reorient or relocate the receiving antenna.
- Increase the separation between the equipment and receiver.
- Connect the equipment into an outlet on a circuit different from that to which the receiver is connected.
- Consult the dealer or an experienced radio/TV technician for help.

Important Safety Information

RF Energy Exposure and Product Safety Guide for Portable Two-Way Radios

ATTENTION!

This radio is restricted to Occupational use only.

Before using the radio, read the RF Energy Exposure and Product Safety Guide for Portable Two-Way Radios which contains important operating instructions for safe usage and RF energy awareness and control for Compliance with applicable standards and Regulations.

For a list of Motorola-approved antennas, batteries, and other accessories, visit the following website:

<http://www.motorolasolutions.com>

Software Version

All the features described in the following sections are supported by the radio's software version **R02.30.01** or later.

See to determine your radio's software version.

Check with your dealer or system administrator for more details of all the features supported.

Computer Software Copyrights

The Motorola products described in this manual may include copyrighted Motorola computer programs stored in semiconductor memories or other media. Laws in the United States and other countries preserve for Motorola certain exclusive rights for copyrighted computer programs including, but not limited to, the exclusive right to copy or reproduce in any form the copyrighted computer program. Accordingly, any copyrighted Motorola computer programs contained in the Motorola products described in this manual may not be copied, reproduced, modified, reverse-engineered, or distributed in any manner without the express written permission of Motorola. Furthermore, the purchase of Motorola products shall not be deemed to grant either directly or by implication, estoppel, or otherwise, any license under the copyrights, patents or patent applications of Motorola, except for the normal non-exclusive license to use that arises by operation of law in the sale of a product.

The AMBE+2™ voice coding Technology embodied in this product is protected by intellectual property rights

including patent rights, copyrights and trade secrets of Digital Voice Systems, Inc.

This voice coding Technology is licensed solely for use within this Communications Equipment. The user of this Technology is explicitly prohibited from attempting to decompile, reverse engineer, or disassemble the Object Code, or in any other way convert the Object Code into a human-readable form.

U.S. Pat. Nos. #5,870,405, #5,826,222, #5,754,974, #5,701,390, #5,715,365, #5,649,050, #5,630,011, #5,581,656, #5,517,511, #5,491,772, #5,247,579, #5,226,084 and #5,195,166.

Handling Precautions

The MOTOTRBO Series Digital Portable radio meets IP55 specifications, allowing the radio to withstand adverse field conditions such as being used in rain or dusty environment.

- If the radio has been exposed to water or rain, shake the radio well to remove any water that may be trapped inside the speaker grille, microphone port and aesthetic cover (if applicable). Trapped water in speaker grille and microphone port could cause decreased audio performance. If aesthetic cover is attached onto radio, trapped water in aesthetic cover could cause corrosion on the slim connector interface gold contacts.
- If the radio's battery contact area has been exposed to water, clean and dry battery contacts on both the radio and the battery before attaching the battery to the radio. The residual water could short-circuit the radio.
- If the radio has been exposed to a corrosive substance (e.g. saltwater), rinse the radio and battery in fresh water then dry the radio and battery.

- To clean the exterior surfaces of the radio, use a diluted solution of mild dishwashing detergent and fresh water (i.e. one teaspoon of detergent to one gallon of water).
- The radio with antenna attached properly is designed to be protected against dust and low pressure jets of water projected with nozzle 6.3mm diameter at flow rate of 12.5 l/min, with water pressure at 30 kN/m² and from a distance of 2.5m to 3m for at least 3 min. Exceeding either maximum limit or use without antenna may result in damage to the radio.
- When cleaning the radio, do not use a high pressure jet spray on the radio as this may cause water to leak into the radio.



Caution: Do not disassemble the radio. This could damage radio seals and result in leak paths into the radio. Radio maintenance should only be done in service depot that is equipped to test and replace the seal on the radio.

Getting Started

How to Use This Guide

This User Guide covers the basic operation of the MOTOTRBO Portables.

However, your dealer or system administrator may have customized your radio for your specific needs. Check with your dealer or system administrator for more information.

Throughout this publication, the icons described next are used to indicate features supported in either the conventional Analog mode or conventional Digital mode:



Indicates a conventional **Analog Mode-Only** feature.



Indicates a conventional **Digital Mode-Only** feature.

For features that are available in **both** conventional Analog and Digital modes, **no** icon is shown.

What Your Dealer/System Administrator Can Tell You

You can consult your dealer or system administrator about the following:

- Is your radio programmed with any preset conventional channels?
- Which buttons have been programmed to access other features?
- What optional accessories may suit your needs?
- What are the best radio usage practices for effective communication?
- What maintenance procedures will help promote longer radio life?

Preparing Your Radio for Use

Charging the Battery

Important: ALWAYS charge your IMPRES battery with an IMPRES charger for optimized battery life and valuable battery data. IMPRES batteries charged exclusively with IMPRES chargers receive a 6-month capacity warranty extension over the standard Motorola Premium battery warranty duration.

Your radio is powered by a Lithium-Ion (Li-Ion) battery. To avoid damage and comply with warranty terms, charge the battery using a Motorola charger *exactly* as described in the charger user guide.

Charge a new battery 14 to 16 hours before initial use for best performance.

Attaching the Battery

- 1 Align the battery with the rails on the back of the radio. Press the battery firmly, and slide upwards until the latch snaps into place.

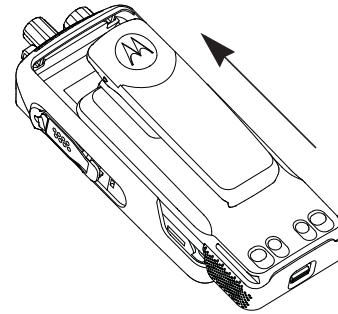

- 2 To remove the battery, turn the radio off. Move the battery latch (A) into unlock position and hold, and slide the battery down and off the rails.

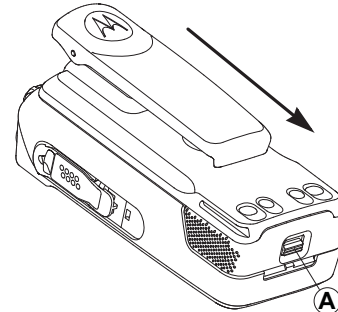

Attaching the Antenna



Caution: If antenna needs to be replaced, ensure that only MOTOTRBO antennas are used. Neglecting this will damage your radio. See [Antennas](#) on page 96 for a list of available antennas.

- 1 With the radio turned off, set the antenna in its receptacle and turn clockwise.

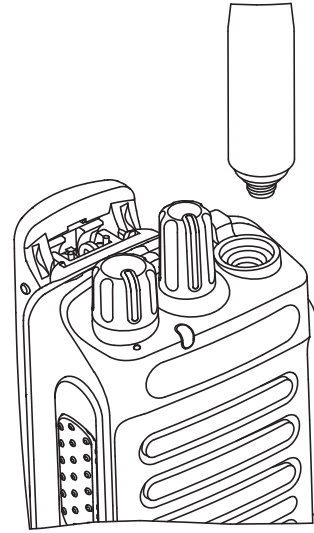

- 2 To remove the antenna, turn the antenna counterclockwise.

Attaching the Belt Clip

- 1 Align the grooves on the clip with those on the battery and press downward until you hear a click.

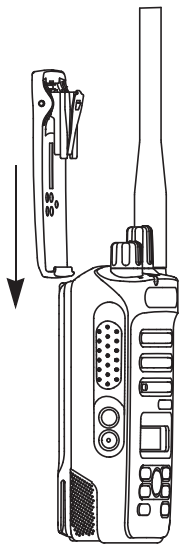

-
- 2** To remove the clip, press the belt clip tab away from the battery using a key. Then slide the clip upward and away from the radio.
-

Attaching the Universal Connector Cover (Dust Cover)

The universal connector is located on the antenna side of the radio. It is used to connect MOTOTRBO accessories to the radio.

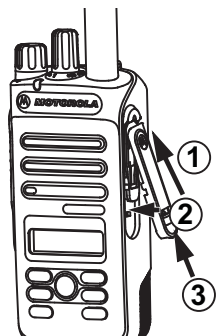

Insert the slanted end of the cover into the slots above the universal connector. Press downward on the cover to seat the dust cover properly on the Universal Connector.

Secure the dust cover to the radio by pushing the latch upwards.

To remove the dust cover, push the latch downwards. Lift the cover up and slide down the dust cover from the universal connector to remove it.

Replace the dust cover when the universal connector is not in use.

Attaching the Accessory Connector

The accessory connector is to be secured to the universal connector on the antenna side of the radio.

- 1 To attach the accessory connector, refer to the steps shown in the diagram.

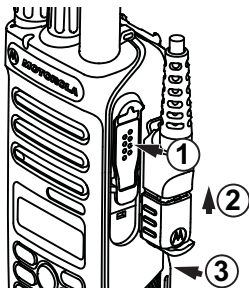

- 2 To remove the accessory connector, refer to the steps shown in the diagram.

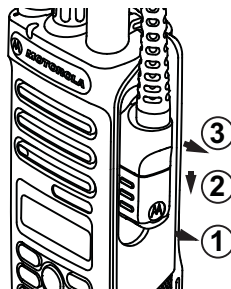

Powering Up the Radio

Rotate the **On/Off/Volume Control Knob** clockwise until you hear a click. You see a welcome message or welcome image.

The LED blinks green (A) if the backlight setting is set to turn on automatically.

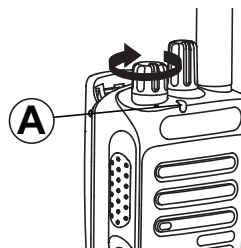

Note: The Home screen does not light up during a power up if the LED indicator is disabled (see [Turning the LED Indicator On or Off](#) on page 86).

A brief tone sounds, indicating that the power up test is successful.

Note: There is no power up tone if the radio tones/alerts function is disabled (see [Turning the Radio Tones/Alerts On or Off](#) on page 83).

If your radio does not power up, check your battery. Make sure that it is charged and properly attached. If your radio still does not power up, contact your dealer.

To turn off the radio, rotate this knob counterclockwise until you hear a click. You see a brief *Powering Down* on the radio's display.

cannot be lowered past the programmed minimum volume. Check with your dealer or system administrator for more information.

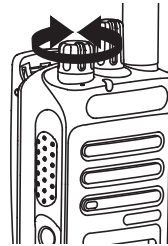

Adjusting the Volume

To increase the volume, turn the **On/Off/Volume Control Knob** clockwise.

To decrease the volume, turn this knob counterclockwise.

Note: Your radio can be programmed to have a minimum volume offset where the volume level

Identifying Radio Controls

Radio Controls



- 1 Channel Selector Knob
- 2 On/Off/Volume Control Knob
- 3 LED Indicator
- 4 Push-to-Talk (PTT) Button
- 5 Microphone
- 6 Side Button 1 ^[1]
- 7 Side Button 2 ^[1]
- 8 Left Navigation Button
- 9 Menu Button
- 10 Front Button P1^[1]
- 11 OK Button
- 12 Front Button P2^[1]
- 13 Back/Home Button
- 14 Right Navigation Button
- 15 Display
- 16 Speaker
- 17 Universal Connector for Accessories
- 18 Antenna

¹ These buttons are programmable.

Additional Radio Controls

Push-To-Talk (PTT) Button

The PTT button on the side of the radio (A) serves two basic purposes:

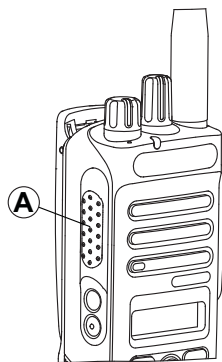



- While a call is in progress, the PTT button allows the radio to transmit to other radios in the call.

Press and hold down PTT button to talk. Release the PTT button to listen.

The microphone is activated when the PTT button is pressed.

- While a call is not in progress, the PTT button is used to make a new call (see [Making a Radio Call](#) on page 34).

If the Talk Permit Tone (see [Turning the Talk Permit Tone On or Off](#) on page 85)  is enabled, wait until the short alert tone ends before talking.

 During a call, if the Channel Free Indication feature is enabled on your radio (programmed by your dealer), you will hear a short alert tone the moment the target radio (the radio that is receiving your call) releases the PTT button, indicating the channel is free for you to respond.

 You will also hear a continuous talk prohibit tone, if your call is interrupted, indicating that you should release the PTT button, for example when the radio receives an Emergency Call.

Programmable Buttons

Your dealer can program the programmable buttons as shortcuts to **radio functions** depending on the duration of a button press:

- Short press – Pressing and releasing rapidly.

- Long press – Pressing and holding for the programmed duration.
- Hold down – Keeping the button pressed.

Note: The programmed duration of a button press is applicable for all assignable radio/utility functions or settings. See *Emergency Operation* on page 57 for more information on the programmed duration of the Emergency button.

Assignable Radio Functions

Contacts — Provides direct access to the Contacts list.

Call Alert — Provides direct access to the contacts list for you to select a contact to whom a Call Alert can be sent.

Call Forwarding — Toggles Call Forwarding on or off.

Call Log — Selects the call log list.

Channel Announcement — Plays zone and channel announcement voice messages for the current channel.

Emergency — Depending on the programming, initiates or cancels an emergency.

Intelligent Audio — Toggles intelligent audio on or off.

Manual Site Roam  — Starts the manual site search.

Mic AGC On/Off — Toggles the internal microphone automatic gain control (AGC) on or off.

Monitor — Monitors a selected channel for activity.

Phone— Provides direct access to the Phone Contacts list

Notifications — Provides direct access to the Notifications list.

Nuisance Channel Delete— Temporarily removes an unwanted channel, except for the Selected Channel, from the scan list. The Selected Channel refers to the user's selected zone/channel combination from which scan is initiated.

One Touch Access  — Directly initiates a predefined Private, Phone or Group Call, a Call Alert or a Quick Text message.

Permanent Monitor— Monitors a selected channel for all radio traffic until function is disabled.

Privacy  — Toggles privacy on or off.

Radio Alias and ID — Provides radio alias and ID.

Radio Check  — Determines if a radio is active in a system.

Radio Enable  — Allows a target radio to be remotely enabled.

Radio Disable  — Allows a target radio to be remotely disabled.

Repeater/Talkaround — Toggles between using a repeater and communicating directly with another radio.

Scan — Toggles scan on or off.

Text Message — Selects the text message menu.

Transmit Interrupt Remote Dekey  — Stops the transmission of a remote monitored radio without giving any indicators, or an ongoing interruptible call to free the channel (A Software License Key sold separately is required to use this feature).

Voice Announcement On/Off — Toggles voice announcement on or off.

Voice Operating Transmission (VOX) — Toggles VOX on or off.

Zone — Allows selection from a list of zones.

Assignable Settings or Utility Functions



Accessing the Programmed Functions

You can access various radio functions through one of the following ways:





- A short or long press of the relevant programmable buttons.
-

² Not applicable in Capacity Plus and Linked Capacity Plus

- 1 Press  to access the menu. Press the appropriate Menu Scroll button ( or ) to access the menu functions.





 - 2 To select a function or enter a sub-menu, press the  button.







 - 3 To go back one menu level, or to return to the previous screen, press the  button. Long press the  button to return to the Home screen.
- Note:** Your radio automatically exits the menu after a period of inactivity and returns to your Home screen.







Identifying Status Indicators

Display Icons

The following are icons that appear on the radio's display.

	<p>Received Signal Strength Indicator (RSSI)</p> <p>The number of bars displayed represents the radio signal strength. Four bars indicate the strongest signal. This icon is only displayed while receiving.</p>
	<p>Monitor</p> <p>Selected channel is being monitored.</p>
	<p>High Volume Data</p> <p>Radio is receiving high volume data and channel is busy.</p>
	<p>Notification</p> <p>Notification List has one or more missed events.</p>
	<p>Power Level</p> <p>Radio is set at Low power or Radio is set at High power.</p>

	Tones Disable Tones are turned off.
	Over-the-Air Programming Delay Timer Indicates time left before automatic restart of radio.
	Scan Scan feature is enabled.
	Scan- Priority 1 Radio detects activity on channel/group designated as Priority 1.
	Scan- Priority 2 Radio detects activity on channel/group designated as Priority 2.
	Vote Scan Vote scan feature is enabled.

	Flexible Receive List Flexible receive list is enabled.
	Emergency Radio is in Emergency mode.
	Secure ⓘ The Privacy feature is enabled.
	Unsecure ⓘ The Privacy feature is disabled.
	Site Roaming ⓘ The site roaming feature is enabled.
	Talkaround In the absence of a repeater, radio is currently configured for direct radio to radio communication.
	Battery

The number of bars (0 – 4) shown indicates the charge remaining in the battery. Blinks when the battery is low.

Call Icons

The following icons appear on the radio's display during a call. These icons also appear in the Contacts list to indicate ID type.



Private Call

Indicates a Private Call in progress. In the Contacts list, it indicates a subscriber alias (name) or ID (number).



Group Call/All Call

Indicates a Group Call or All Call in progress. In the Contacts list, it indicates a group alias (name) or ID (number).



Phone Call as Private Call

Indicates a Phone Call as Private Call in progress. In the Contacts list, it indicates a phone alias (name) or ID (number).



Phone Call as Group Call

Indicates a Phone Call as Group/All Call in progress. In the Contacts list, it indicates a phone alias (name) or ID (number).

Advanced Menu Icons

The following icons appear beside menu items that offer a choice between two options or as an indication that there is a sub-menu offering two options.



Checkbox (Empty)

Indicates the option is not selected.



Checkbox (Checked)

Indicates the option is selected.





Solid Black Box

Indicates the option selected for the menu item with a sub-menu.







Mini Notice Icons

The following icons appear momentarily on the radio's display after an action to perform task is taken.

	<p>Successful Transmission (Positive)</p> <p>Successful action taken.</p>
	<p>Failed Transmission (Negative)</p> <p>Failed action taken.</p>
	<p>Transmission in Progress (Transitional)</p> <p>Transmitting. This is seen before indication for Successful Transmission or Failed Transmission.</p>

Sent Item Icons

The following icons appear at the top right corner of the radio's display in the Sent Items folder.

 OR 	<p>Sent Successfully</p> <p>The text message has been successfully sent.</p>
 OR 	<p>Send Failed</p> <p>The text message cannot be sent.</p>
 OR 	<p>In Progress</p> <ul style="list-style-type: none"> • The text message to a group alias or ID is pending transmission. • The text message to a subscriber alias or ID is pending transmission, followed by waiting for acknowledgement.

LED Indicator

The LED indicator (A) shows the operational status of your radio.

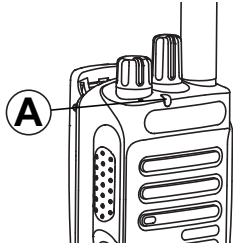

Blinking red	Radio is transmitting at low battery condition, receiving an emergency transmission or has failed the self-test upon powering up, or has moved out of range if radio is configured with Auto-Range Transponder System.
Solid yellow	Radio is monitoring a conventional channel. Also indicates fair battery charge when programmable button is pressed.





Blinking yellow	Radio is scanning for activity or receiving a Call Alert or flexible receive list is enabled.
Double blinking yellow	Auto Roaming is enabled, and radio is actively searching for a new site. Also indicates that radio has yet to respond to a group call alert, or radio is locked.
Solid green	Radio is powering up or transmitting. Also indicates full charge of the battery when the programmable button is pressed.
Blinking green	Radio is powering up, receiving a non-privacy-enabled call or data, detecting activity, or retrieving Over-the-Air Programming transmissions over the air.
Rapidly blinking green 	Radio is receiving a privacy-enabled call or data.

Note:



While in conventional mode, when the LED blinks green, it indicates the radio detects activity over the air. Due to the nature of the digital protocol, this activity may or may not affect the radio's programmed channel.

Audio Tones

Alert tones provide you with audible indications of the radio's status or the radio's response to data received.

Continuous Tone 	A monotone sound. Sounds continuously until termination.
Periodic Tone 	Sounds periodically depending on the duration set by the radio. Tone starts, stops, and repeats itself.
Repetitive Tone 	A single tone that repeats itself until it is terminated by the user.
Momentary Tone 	Sounds only once for a short period of time defined by the radio.

Indicator Tones

High pitched tone	<input type="checkbox"/>	Low pitched tone	<input checked="" type="checkbox"/>
		Positive Indicator Tone	
		Negative Indicator Tone	

Switching Between Conventional Analog and Digital Mode

Each channel in your radio can be configured as a conventional analog or conventional digital channel. Use the Channel Selector Knob (A) to switch between an analog or a digital channel.

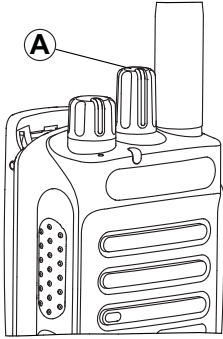

When switching from digital to analog mode, certain features are unavailable. Icons for the digital features (such as Messages) reflect this change by appearing 'grayed out'. Disabled features are hidden in the menu.

Your radio also has features available in both analog and digital mode. However, the minor differences in the way each feature works does **NOT** affect the performance of your radio.

Note:





Your radio also switches between digital and analog modes during a dual mode scan (see [Scan](#) on page 46).

Making and Receiving Calls

Selecting a Zone

A zone is a group of channels. Your radio supports up to 128 channels and 50 zones, with a maximum of 16 channels per zone.





- 1 Access the Zone feature.

Radio Controls	Steps
Programmed Zone button	Press the programmed Zone button.
Radio menu	<ol style="list-style-type: none"> 1  to access the menu. 2  or  to Zone and press  to select.

The current zone is displayed and indicated by a ✓.

- 2 Select the required zone.

Radio Control Steps

 or   or  and scroll to the required zone.

- 3 Press  to select.
The display shows <Zone> Selected momentarily and returns to the selected zone screen.

Selecting a Channel

Transmissions are sent and received on a channel. Depending on your radio's configuration, each channel may have been programmed differently to support different groups of users or supplied with different features. After selecting the relevant Zone, select the relevant channel you require to transmit or receive on.

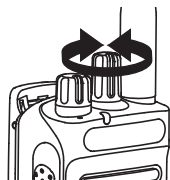

- Once the required zone is displayed (if you have multiple zones in your radio), turn the programmed Channel Selector Knob to select the channel.

Receiving and Responding to a Radio Call

Once the channel, subscriber ID or group ID is displayed, you can proceed to receive and respond to calls.

The LED lights up solid green while the radio is transmitting and blinks green when the radio is receiving.

Note: The LED lights up solid green while the radio is transmitting and blinks green rapidly when the radio is receiving a privacy-enabled call and blinks green when receiving a non-privacy-enabled call. To unscramble a privacy-enabled call, your radio must have the same Privacy Key, OR the same Key Value and Key ID (programmed by your dealer), as the transmitting radio (the radio you are receiving the call from).



Note: See [Privacy](#) on page 71 for more information.



Receiving and Responding to a Group Call

To receive a call from a group of users, your radio must be configured as part of that group.

When you receive a Group Call (while on the Home screen), the LED blinks green. The Group Call icon appears in the top right corner. The first text line shows the caller alias. The second text line displays the group call alias. Your radio unmutes and the incoming call sounds through the radio's speaker.

- 1 Hold the radio vertically 1 to 2 inches (2.5 to 5.0 cm) from your mouth.
 -  If the Channel Free Indication feature is enabled, you hear a short alert tone the moment the transmitting radio releases the **PTT** button, indicating the channel is free for you to respond. Press the **PTT** button to respond.
 -  If the Voice Interrupt feature is enabled, press the **PTT** button to stop the current call from the transmitting radio and free the channel for you to talk/respond.

The LED lights up solid green.

- 2 Wait for one of the following tones to finish (if enabled), and speak clearly into the microphone.
 - the Talk Permit Tone
 -  the **PTT** Sidetone

3 Release the **PTT** button to listen.

If there is no voice activity for a predetermined period of time, the call ends.

Note: See [Making a Group Call](#) on page 35 for details on making a Group Call.

Note: If the radio receives a Group Call while not on the Home screen, it remains on its current screen prior to answering the call.

Note: Long press the  button to go to the Home screen to view the caller alias before replying.

Receiving and Responding to a Private Call



A Private Call is a call from an individual radio to another individual radio.

Depending on how your radio is programmed,

- The LED lights up solid yellow momentarily. Then, the LED blinks green.

- The LED blinks green.

The first text line shows private call icon. The second text line displays the private call alias. Your radio unmutes and the incoming call sounds through the radio's speaker.

- 1 Hold the radio vertically 1 to 2 inches (2.5 to 5.0 cm) from your mouth.
 -  If the Channel Free Indication feature is enabled, you hear a short alert tone the moment the transmitting radio releases the **PTT** button, indicating the channel is free for you to respond. Press the **PTT** button to respond.
 -  If the Voice Interrupt feature is enabled, press the **PTT** button to stop the current call from the transmitting radio and free the channel for you to talk/respond.

The LED lights up solid green.

- 2 Wait for the Talk Permit Tone to finish (if enabled), and speak clearly into the microphone.
-
- 3 Release the **PTT** button to listen.

If there is no voice activity for a predetermined period of time, the call ends.

The display shows `Call Ended`.

See [Making a Private Call](#) on page 35 for details on making a Private Call.

Receiving an All Call

An All Call is a call from an individual radio to every radio on the channel. It is used to make important announcements requiring the user's full attention.

When you receive an All Call, a tone sounds and the LED blinks green.

The Group Call icon appears in the top right corner. The first text line shows the caller alias. The second text line displays `All Call`. Your radio unmutes and the incoming call sounds through the radio speaker.

Once the All Call ends, the radio returns to the previous screen before receiving the call. An All Call does not wait for a predetermined period of time before ending.

 If the Channel Free Indication feature is enabled, you will hear a short alert tone the moment the

transmitting radio releases the **PTT** button, indicating the channel is now available for use.

You cannot respond to an All Call.

Note: See [Making an All Call](#) on page 36 for details on making an All Call.

Note: The radio stops receiving the All Call if you switch to a different channel while receiving the call. During an All Call, you will **not** be able to use any programmed button functions until the call ends.

Receiving and Responding to a Selective Call

A Selective Call is a call from an individual radio to another individual radio. It is a Private Call on an analog system.

When you receive a Selective Call, the LED blinks green. The Private Call icon appears in the top right corner. The first text line shows the caller alias or `Selective Call` or `Alert with Call`. Your radio unmutes and the incoming call sounds through the radio's speaker.

- 1 Hold the radio vertically 1 to 2 inches (2.5 to 5.0 cm) from your mouth.

 If the Channel Free Indication feature is enabled, you hear a short alert tone the moment the transmitting radio releases the **PTT** button, indicating the channel is free for you to respond.

- 2 Press the **PTT** button to respond to the call. The LED lights up solid green.
- 3 Wait for the Talk Permit Tone to finish (if enabled), and speak clearly into the microphone.
- 4 Release the **PTT** button to listen.

If there is no voice activity for a predetermined period of time, the call ends.

The display shows *Call Ended*.

See [Making a Private Call](#) on page 35 for details on making a Private Call.

Receiving and Responding to a Phone Call

Phone Call as Private Call

When you receive a Phone Call as a Private Call, the Phone Call icon appears in the top right corner; the display shows the caller alias or *Phone Call*.

If Phone Call capability is not enabled in your radio, the first line of the display shows *Unavailable* and your radio mutes the call. Your radio returns to the previous screen when the call ends.

- 1 Press the **PTT** button to talk and release it to listen.
- 2 Press  to end the call.

Phone Call as Group Call

When you receive a Phone Call as a Group Call, the Phone Group Call icon appears in the top right corner; the display shows the group alias and *Phone Call*.

If Phone Call capability is not enabled in your radio, the first line of the display shows *Unavailable* and your radio mutes the call. Your radio returns to the previous screen when the call ends.

- 1 Press the **PTT** button to talk and release it to listen.
- 2 Press  to end the call.
The display shows *Ending Phone Call*.

If successful, a tone sounds and the display shows `Call Ended`.

If unsuccessful, your radio returns to the Phone Call screen. Repeat Step 2 on page 33 to end the call.

Phone Call as All Call

When you receive a Phone Call as an All Call, the Phone Call icon appears in the top right corner; the display shows `All Call` and `Phone Call`.

If Phone Call capability is not enabled in your radio, the first line of the display shows `Unavailable` and your radio mutes the call. Your radio returns to the previous screen when the call ends.

Note: When you receive a Phone Call as an All Call, you can respond to the call or end the call, only if an All Call type is assigned to the channel.



- 1 Press the **PTT** button to talk and release it to listen.
- 2 Press  to end the call.
The display shows `Ending Phone Call`.

If successful, a tone sounds and the display shows `All Call` and `Call Ended`.

If unsuccessful, your radio returns to the Phone Call screen. Repeat Step 3 or wait for the telephone user to end the call.

Making a Radio Call

After selecting your channel, you can select a subscriber alias or ID, or group alias or ID by using:

- The Channel Selector Knob.
- A programmed **One Touch Access** button (See [Making a Phone Call with the One Touch Access Button](#) on page 38)
.
- A programmable button – This method is for Phone Calls only (see [Making a Phone Call with the Programmable Phone Button](#) on page 39). .
- The Contacts list (see [Contact Settings](#) on page 48).

Note: Your radio must have the Privacy feature enabled on the channel to send a privacy-enabled transmission. Only target radios with the same Privacy Key OR the same Key Value and Key ID as

your radio will be able to unscramble the transmission.

Note: See [Privacy](#) on page 71 for more information.



Making a Group Call

To make a call to a group of users, your radio must be configured as part of that group.

- 1 Do one of the following.
 - Select the channel with the active group alias or ID. See [Selecting a Channel](#) on page 29
 - Press the programmed **One Touch Access** button.

-
- 2 Hold the radio vertically 1 to 2 inches (2.5 to 5.0 cm) from your mouth.

-
- 3 Press the **PTT** button to make the call. The LED lights up solid green. The first text line shows the group call icon. The second text line shows the group call alias.

-
- 4 Wait for one of the following tones to finish (if enabled), and speak clearly into the microphone.
 - the Talk Permit Tone

- the **PTT** Sidetone

-
- 5 Release the **PTT** button to listen.

When the target radio responds, the LED blinks green. You see the Group Call icon, the group alias or ID, and transmitting radio alias or ID on your display.

-
- 6 If the Channel Free Indication feature is enabled, you hear a short alert tone the moment the transmitting radio releases the **PTT** button, indicating the channel is free for you to respond. Press the **PTT** button to respond.

If there is no voice activity for a predetermined period of time, the call ends. Radio returns to the screen you were on prior to initiating the call.

Making a Private Call

While you can receive and/or respond to a Private Call initiated by an authorized individual radio, your radio must be programmed for you to initiate a Private Call.

There are two types of Private Calls. The first type, where a radio presence check is performed prior to

setting up the call, while the other sets up the call immediately.

Only **one** of these call types can be programmed to your radio by your dealer.

You will hear a negative indicator tone, when you make a Private Call via the Contacts list, Call Log, **One Touch Access** button, the programmed number keys, or the Channel Selector Knob, if this feature is not enabled.

Use the Quick Text Message or Call Alert features to contact an individual radio. See [Text Message Features](#) on page 61 or [Call Alert Operation](#) on page 56 for more information.

- 1 Do one of the following.
 - Select the channel with the active subscriber alias or ID. See [Selecting a Channel](#) on page 29
 - Press the programmed **One Touch Access** button.

- 2 Hold the radio vertically 1 to 2 inches (2.5 to 5.0 cm) from your mouth.

- 3 Press the PTT button to make the call.

The LED lights up solid green. The first text line shows the private call icon. The second text line displays the private call alias.

- 4 Wait for the Talk Permit Tone to finish (if enabled), and speak clearly into the microphone.

 - 5 Release the **PTT** button to listen.
When the target radio responds, the LED blinks green.

 - 6  If the Channel Free Indication feature is enabled, you hear a short alert tone the moment the transmitting radio releases the **PTT** button, indicating the channel is free for you to respond. Press the **PTT** button to respond.

If there is no voice activity for a predetermined period of time, the call ends. You hear a short tone. The display shows `Call Ended`.
-

You can also make a Private Call via Contacts (see [Making a Private Call from Contacts](#) on page 50).

Making an All Call

This feature allows you to transmit to all users on the channel. Your radio must be programmed to allow you to use this feature.

Users on the channel cannot respond to an All Call.

1 Select the channel with the active All Call group alias or ID. See [Selecting a Channel](#) on page 29

2 Hold the radio vertically 1 to 2 inches (2.5 to 5.0 cm) from your mouth.

3 Press the **PTT** button to make the call. The LED lights up solid green. The first text line shows the All Call icon. The second text line displays the All Call alias.

4 Wait for one of the following tones to finish (if enabled), and speak clearly into the microphone.

- the Talk Permit Tone
 -  the **PTT** Sidetone
-

Making a Selective Call

Just like a Private Call, while you can receive and/or respond to a Selective Call initiated by an authorized individual radio, your radio must be programmed for you to initiate a Selective Call.

1 Select the channel with the active subscriber alias or ID. See [Selecting a Channel](#) on page 29

2 Hold the radio vertically 1 to 2 inches (2.5 to 5.0 cm) from your mouth.

3 Press the **PTT** button to make the call. The LED lights up solid green. The Private Call icon appears in the top right corner. The first text line shows the subscriber alias. The second text line displays the call status.

4 Wait for one of the following tones to finish (if enabled), and speak clearly into the microphone.

- the Talk Permit Tone
 -  the **PTT** Sidetone
-

5 Release the **PTT** button to listen.

When the target radio responds, the LED blinks green.

 If the Channel Free Indication feature is enabled, you hear a short alert tone the moment the transmitting radio releases the **PTT** button, indicating the channel is free for you to respond. Press the **PTT** button to respond.

If there is no voice activity for a predetermined period of time, the call ends.

The display shows `Call Ended`.

Making a Phone Call with the One Touch Access Button

- 1 Press the programmed **One Touch Access** button to make a Phone Call to the predefined alias or ID.

If the entry for the **One Touch Access** button is empty, a negative indicator tone sounds. If the access code was not preconfigured in the Contacts list, the display shows `Access Code:`.

Enter the access code and press  to proceed.

The LED lights up solid green. The Phone Call icon appears in the top right corner. The first text line shows the subscriber alias. The second text line displays the call status.

If the call-setup is successful, the DTMF tone sounds. You hear the dialing tone of the telephone user.

If the call-setup is unsuccessful, a tone sounds and the display shows `Phone Call Failed`. Your radio returns to the Access Code input screen. If the access code was preconfigured in the

Contacts list, the radio returns to the screen you were on prior to initiating the call.

-
- 2 Hold the radio vertically 1 to 2 inches (2.5 to 5.0 cm) from your mouth.
 - 3 Press the PTT button to talk and release it to listen.
 - 4 Press  to end the call.

If de-access code was not preconfigured in the Contacts list, the display shows `De-Access Code:`. Do one of the following.



- Enter the de-access code and press  to proceed. The radio returns to the previous screen.
- Press the **One Touch Access** button. If the entry for the **One Touch Access** button is empty, a negative indicator tone sounds.

The DTMF tone sounds with each keypad press, and the display shows `Ending Phone Call`.

If the end-call-setup is successful, a tone sounds and the display shows `Call Ended`.

If the end-call-setup is unsuccessful, your radio returns to the Phone Call. Repeat Step 4 on page 38 or wait for the telephone user to end the call.

Making a Phone Call with the Programmable Phone Button

- 1 Press the programmed **Phone** button to enter into the Phone Entry list.
- 2  or  to the required subscriber alias or ID, and press  to select.

The LED lights up solid green. The Phone Call icon appears in the top right corner. The first text line shows the subscriber alias. The second text line displays the call status.

If the call-setup is successful, the DTMF tone sounds. You hear the dialing tone of the telephone user. The first text line shows the subscriber alias. The Phone Call icon remains in the top right corner.

If call-setup is unsuccessful, a tone sounds and the display shows `Phone Call Failed`. Your radio returns to the Access Code input screen. If

the access code was preconfigured in the Contacts list, the radio returns to the screen you were on prior to initiating the call.

- 3 Hold the radio vertically 1 to 2 inches (2.5 to 5.0 cm) from your mouth.
- 4 Press the **PTT** button to talk and release it to listen.
- 5 To enter extra digits, if requested by the Phone Call, Press **One Touch Access** button. If the entry for the **One Touch Access** button is empty, a negative indicator tone sounds.
- 6 Press  to end the call.

The display shows `Ending Phone Call`.

If the end-call-setup is successful, a tone sounds and the display shows `Call Ended`.

If the end-call-setup is unsuccessful, your radio returns to the Phone Call screen. Repeat Step 4 on page 39 or wait for the telephone user to end the call.

When you press **PTT** button while in the Phone Contacts screen, a tone sounds and the display shows `Press OK to Place Phone Call`.

When the telephone user ends the call, a tone sounds and the display shows `Phone Call Ended`.

If the call ends while you are entering the extra digits requested by the Phone Call, your radio returns to the screen you were on prior to initiating the call.

Note: During channel access, press  to dismiss the call attempt and a tone sounds.

Note: During the call, when you press **One Touch Access** button with the deaccess code preconfigured or enter the deaccess code as the input for extra digits, your radio attempts to end the call.

Note: The access or deaccess code cannot be more than 10 characters.

Stopping a Radio Call

This feature allows you to stop an ongoing Group or Private Call to free the channel for transmission. For example, when a radio experiences a “stuck microphone” condition where the **PTT** button is inadvertently pressed by the user.

Your radio must be programmed to allow you to use this feature.

1 Press the programmed **Transmit Interrupt Remote Dekey** button, while on the relevant channel.
The display shows `Remote Dekey`.

2 Wait for acknowledgment.

The radio sounds a positive indicator tone and the display shows `Remote Dekey Success`, indicating that the channel is now free. The remote radio's display shows `Call Interrupted`, and the radio sounds a negative indicator tone until the **PTT** button is released.

OR

The radio sounds a negative indicator tone and the display shows `Remote Dekey Failed`.

Talkaround



You can continue to communicate when your repeater is not operating, or when your radio is out of the repeater's range but within talking range of other radios.



This is called "talkaround".



The Talkaround setting is retained even after powering down.

You can toggle between talkaround and repeater modes by pressing the programmed **Repeater/Talkaround** button **OR** using the radio menu as described next.

- 1  to access the menu.

- 2  or  to `Utilities` and press  to select.

- 3  or  to `Radio Settings` and press  to select.

- 4  or  to `Talkaround` and press  to select.

You can also use  or  to change the selected option.

- 5 Press  to enable/disable the Talkaround.
The display shows ✓ beside Enabled.
The ✓ disappears from beside Enabled.

Monitoring Features

Monitoring a Channel

Use the Monitor feature to make sure a channel is clear before transmitting.

- 1 Press and hold the programmed **Monitor** button and listen for activity.

The Monitor icon appears on the display and the LED lights up solid yellow. You hear radio activity or total silence, depending on how your radio is programmed. This indicates that the channel is in use.

- 2  Wait until you hear “white noise”. This indicates that the channel is free.
 - 3 Press the **PTT** button to talk and release it to listen.
-

Radio sounds an alert tone, the LED turns off, and display shows Radio sounds an alert tone, the LED turns off.

Permanent Monitor

Use the Permanent Monitor feature to continuously monitor a selected channel for activity.

- 1 Press the programmed **Permanent Monitor** button to activate permanent monitoring of the channel.
Radio sounds an alert tone, the LED lights up solid yellow, and the display shows `Permanent Monitor On`. The Monitor icon appears on the display.
- 2 Press the programmed **Permanent Monitor** button to exit Permanent Monitor mode.

Advanced Features





Radio Check







If enabled, this feature allows you to determine if another radio is active in a system without disturbing the user of that radio. No audible or visual notification is shown on the target radio.

This feature is only applicable for subscriber aliases or IDs.

Sending a Radio Check

- 1 Access the Radio Check feature.

Radio Control	Steps
Programmed Radio Check button	<ol style="list-style-type: none"> 1 Press the programmed Radio Check button. 2  or  to the required subscriber alias or ID and press  to select.
Menu	<ol style="list-style-type: none"> 1  to access the menu

Radio Control	Steps
	<ol style="list-style-type: none"> 2  or  to Contacts and press  to select 3  or  to Radio Check and press  to select.

The display shows The LED lights up solid green.

- 2 Wait for acknowledgement.

If the  button is pressed when the radio is waiting for acknowledgement, a tone sounds, and the radio terminates all retries and exits Radio Check mode.

Radio returns to the subscriber alias or ID screen.

Scan Lists

Scan lists are created and assigned to individual channels/ groups. Your radio scans for voice activity by cycling through the channel/group sequence



specified in the scan list for the current channel/
group.



Your radio can support up to 250 scan lists, with a
maximum of 16 members in a list. Each scan list
supports a mixture of both analog and digital entries.



You can add, delete, or prioritize channels by editing
a scan list.

Viewing an Entry in the Scan List

- 1  to access the menu.

- 2  or  to Scan and press  to select.

- 3  or  to View/Edit List and press  to select.

- 4 Use  or  to view each member on the list.



The Priority icon appears left of the member's
alias, if set, to indicate whether the member is on
a Priority 1 or Priority 2 channel list. You **cannot**
have multiple Priority 1 or Priority 2 channels in a
scan list.



There is no Priority icon if priority is set to **None**.



Editing the Scan List



Adding a New Entry to the Scan List



- 1  to access the menu.

- 2  or  to Scan and press  to select.







- 3  or  to View/Edit List and press  to select.

- 4  or  to Add Member and press  to select.













- 5  or  to the required alias or ID.







- 6  or  to the required priority level and
press  to select.
The display shows , followed immediately by Add
Another?.

- 7 Do one of the following:

-  or  to Yes and press  to select, and repeat Steps 5 on page 44 to 6 on page 44.
-  or  to No and press  to save the current list.









Deleting an Entry from the Scan List



- 1  to access the menu.
- 2  or  to Scan and press  to select.
- 3  or  to View/Edit List and press  to select.
- 4  or  to the required alias or ID.
- 5 Press  to select.
- 6  or  to Delete and press  to select.
- 7 Do one of the following:



- At Delete Entry?,  or  to Yes and press  to delete entry. The display shows Entry Deleted.
-  or  to No and press  to return to the previous screen.

-
- 8 Repeat Steps 4 on page 45 to 6 on page 45 delete other entries.
After deleting all required aliases or IDs, long press  to return to the Home screen.

Setting and Editing Priority for an Entry in the Scan List

- 1  to access the menu.
- 2  or  to Scan and press  to select.
- 3  or  to View/Edit List and press  to select.
- 4 Press  to select.

5  or  to Edit Priority and press  to select.

6  or  to the required priority level and press  to select.
The display shows before returning to the previous screen.

Note:

The Priority icon appears left of the member's name.

There is no Priority icon if priority is set to **None**.

Scan

When you start a scan, your radio cycles through the programmed scan list for the current channel looking for voice activity.

The LED blinks yellow.

There are two ways of initiating scan:

- **Main Channel Scan (Manual):** Your radio scans all the channels/groups in your scan list. On entering scan, your radio may – depending on the

settings – automatically start on the last scanned “active” channel/group or on the channel where scan was initiated.



- **Auto Scan (Automatic):** Your radio automatically starts scanning when you select a channel/group that has Auto Scan enabled.



Starting and Stopping Scan



You can start and stop scanning by pressing the programmed **Scan** button **OR** follow the procedure described next.

- 1 Use the Channel Selector Knob to select a channel programmed with a scan list.

2  to access the menu.

3  or  to Scan and press  to select.

4  or  to Scan State and press  to select.

5  or  to required scan state and press  to select.

- The display shows **Scan On** when Scan is enabled. The LED blinks yellow and the scan icon appears.
- The display shows **Scan Off** if Scan is disabled. The LED turns off and the scan icon disappears.

Responding to a Transmission During a Scan

During scanning, your radio stops on a channel/group where activity is detected. The radio stays on that channel for a programmed time period known as “hang time”.

- 1 Hold the radio vertically 1 to 2 inches (2.5 to 5.0 cm) from your mouth.

 If the Channel Free Indication feature is enabled, you hear a short alert tone the moment the transmitting radio releases the **PTT** button, indicating the channel is free for you to respond.

- 2 Press the **PTT** button during hang time. The LED lights up solid green.
- 3 Wait for one of the following tones to finish (if enabled), and speak clearly into the microphone.
 - the Talk Permit Tone

-  the **PTT** Sidetone

-
- 4 Release the **PTT** button to listen.

If you do not respond within the hang time, the radio returns to scanning other channels/groups.

Deleting a Nuisance Channel

If a channel continually generates unwanted calls or noise (termed a “nuisance” channel), you can temporarily remove the unwanted channel from the scan list.

This capability does not apply to the channel designated as the Selected Channel.

- 1 When your radio “locks on to” an unwanted or nuisance channel, press the programmed **Nuisance Channel Delete** button until you hear a tone.
 - 2 Release the **Nuisance Channel Delete** button. The nuisance channel is deleted.
-

Restoring a Nuisance Channel

To restore the deleted nuisance channel, do one of the following:

- Turn the radio off and then power it on again.
- Stop and restart a scan via the programmed **Scan** button or menu.
- Change the channel via the Channel Selector Knob.

Vote Scan

Vote Scan provides you with wide area coverage in areas where there are multiple base stations transmitting identical information on different analog channels.

Your radio scans analog channels of multiple base stations and performs a voting process to select the strongest received signal. Once that is established, your radio unmutes to transmissions from that base station.

The LED blinks yellow .

To respond to a transmission during a Vote Scan, follow the same procedures as [Responding to a Transmission During a Scan](#) on page 47.

Contact Settings

Contacts provides “address-book” capabilities on your radio. Each entry corresponds to an alias or ID that you use to initiate a call.

Each entry, depending on context, associates with **one** of five types of calls: Group Call, Private Call, All Call, PC Call or Dispatch Call.

PC Call and Dispatch Call are data-related. They are only available with the applications. Refer to the data applications documentation for more information.

Note:

If the Privacy feature is enabled on a channel, you can make privacy-enabled Group Call, Private Call, and All Call on that channel. Only target radios with the same Privacy Key OR the same Key Value and Key ID as your radio will be able to unscramble the transmission.

See [Privacy](#) on page 71 for more information. 

Your radio supports two Contacts lists, one for Analog contacts and one for Digital contacts, with a maximum of 500 members for each Contacts list.

Each entry within Contacts displays the following information:

- Call Type
- Call Alias
- Call ID



Note:



You can add or edit subscriber IDs for the Digital Contacts list. Deleting subscriber IDs can only be performed by your dealer.

For the Analog Contacts list, you can only view the subscriber IDs, edit the subscriber IDs, and initiate a Call Alert. Adding and deleting capabilities can only be performed by your dealer.

Making a Group Call from Contacts

- 1  to access the menu.

- 2  or  to **Contacts** and press  to select.
The entries are alphabetically sorted.

- 3  or  to the required group alias or ID.

- 4 Hold the radio vertically 1 to 2 inches (2.5 to 5.0 cm) from your mouth.

- 5 Press the **PTT** button to make the call.
The LED lights up solid green.



- 6 Wait for one of the following tones to finish (if enabled), and speak clearly into the microphone.
 - the Talk Permit Tone
 -  the **PTT** Sidetone



- 7 Release the **PTT** button to listen.
When any user in the group responds, the LED blinks green. You see the Group Call icon, the group ID, and the user's ID on your display.

- 8  If the Channel Free Indication feature is enabled, you hear a short alert tone the moment the transmitting radio releases the **PTT** button, indicating the channel is free for you to respond. Press the **PTT** button to respond.
If there is no voice activity for a predetermined period of time, the call ends.

Making a Private Call from Contacts

- 1  to access the menu.

- 2  or  to `Contacts` and press  to select.
The entries are alphabetically sorted.

- 3  or  to the required subscriber alias or ID and press  to select.

- 4 Hold the radio vertically 1 to 2 inches (2.5 to 5.0 cm) from your mouth.

- 5 Press the **PTT** button to make the call.
The LED lights up solid green. The display shows the destination alias.

- 6 Wait for the Talk Permit Tone to finish (if enabled), and speak clearly into the microphone.

- 7 Release the **PTT** button to listen.
When the target radio responds, the LED blinks green and the display shows the transmitting user's ID.



- 8  If the Channel Free Indication feature is enabled, you hear a short alert tone the moment the transmitting radio releases the **PTT** button, indicating the channel is free for you to respond. Press the **PTT** button to respond.



If there is no voice activity for a predetermined period of time, the call ends.



The display shows `Call Ended`.

Setting a Default Contact

- 1  to access the menu.

- 2  or  to `Contacts` and press  to select.

- 3  or  to the required alias or ID and press  to select.

- 4  or  to `Set as Default` and press  to select.

The radio sounds a positive indicator tone and the display shows positive mini notice.

A ✓ appears beside the selected default alias or ID.

Call Indicator Settings

Activating and Deactivating Call Ringers for Call Alert



You can select, or turn on or off ringing tones for a received Call Alert.

- 1 to access the menu.

- 2 or to Utilities and press to select.

- 3 or to Radio Settings and press to select.

- 4 or to Tones/Alert and press to select.

- 5 or to Call Ringers and press to select.

- 6 or to Call Alert and press to select.

The current tone is indicated by a ✓.

- 7 or to the required tone and press to select.



You can also use or to change the selected option.



✓ appears beside selected tone.

Activating and Deactivating Call Ringers for Private Calls



You can turn on or off the ringing tones for a received Private Call.



- 1 to access the menu.



2  or  to Utilities and press  to select.

3  or  to Radio Settings and press  to select.

4  or  to Tones/Alerts and press  to select.

5  or  to Call Ringers and press  to select.



6  or  to Private Call and press  to select.



You can also use  or  to change the selected option.

Activating and Deactivating Call Ringers for Selective Call



You can select, or turn on or off ringing tones for a received Selective Call.



1  to access the menu.

2  or  to Utilities and press  to select.



3  or  to Radio Settings and press  to select.



4  or  to Tones/Alert and press  to select.

5  or  to Call Ringers and press  to select.

6  or  to Selective Call and press  to select.













The current tone is indicated by a ✓



You can also use  or  to change the selected option.

- 7  or  to the required tone and press  to select.
✓ appears beside selected tone.
-

Activating and Deactivating Call Ringers for Text Message

You can turn on or off the ringing tones for a received Text Message.











- 1  to access the menu.
-
- 2  or  to `Utilities` and press  to select.
-
- 3  or  to `Radio Settings` and press  to select.
-
- 4  or  to `Tones/Alerts` and press  to select.
-
- 5  or  to `Call Ringers` and press  to select.
-

- 6  or  to `Text Message` and press  to select.
The current tone is indicated by a ✓.
-



Assigning Ring Styles

You can program your radio to sound one of ten predefined ringing tones when receiving a Call Alert or a Text Message from a particular contact.

The radio sounds out each ring style as you navigate through the list.











- 1  to access the menu.
-
- 2  or  to `Contacts` and press  to select.
The entries are alphabetically sorted.
-
- 3  or  to the required alias or ID and press  to select.
-
- 4  or  to and press  to select.
-

A ✓ indicates the current selected tone.

- 5  or  to the required tone and press  to select.
The display shows `Contact Saved`.
-

Escalating Alarm Tone Volume

You can program your radio to continually alert you when a radio call remains unanswered. This is done by automatically increasing the alarm tone volume over time. This feature is known as Escalert.

- 1  to access the menu.
-
- 2  or  to `Utilities` and press  to select.
-
- 3  or  to `Radio Settings` and press  to select.
-
- 4  or  to `Tones/Alerts` and press  to select.
-

- 5  or  to `Escalert` and press  to select.

You can also use  or  to change the selected option.

- 6 Press  to enable/disable the Escalert.
The display shows ✓ beside `Enabled`.
The ✓ disappears from beside `Enabled`.
-

Call Log Features

Your radio keeps track of all recent outgoing, answered, and missed Private Calls. Use the call log feature to view and manage recent calls.



You can perform the following tasks in each of your call lists:



- Delete
- View Details



Viewing Recent Calls

The lists are `Missed`, `Answered`, and `Outgoing`.

- 1  to access the menu.



- 2  or  to Call Log and press  to select.



- 3  or  to preferred list and press  to select.
The display shows the most recent entry at the top of the list.

- 4  or  to view the list.
Press the **PTT** button to start a Private Call with the current selected alias or ID.



Deleting a Call from a Call List



- 1  to access the menu.





- 2  or  to Call Log and press  to select.

- 3  or  to the required list and press  to select.

When you select a call list and it contains no entries, the display shows *List Empty*.



- 4  or  to the required alias or ID and press  to select.



- 5  or  to Delete Entry? and press  to select.



- 6 Do one of the following:
 - Press  to select Yes to delete the entry. The display shows *Entry Deleted*.
 -  or  to No, and press the  button to return to the previous screen.



Viewing Details from a Call List

- 1  to access the menu.

- 2  or  to Call Log and press  to select.

3  or  to the required list and press  to select.

4  or  to the required alias or ID and press  to select.

5  or  to `View Details` and press  to select.
Display shows details.

Call Alert Operation

Call Alert paging enables you to alert a specific radio user to call you back when they are able to do so.

This feature is applicable for subscriber aliases or IDs only and is accessible through the menu via `Contacts` or manual dial.

Receiving and Responding to a Call Alert

When you receive a Call Alert page, you see the notification list listing a Call Alert with the alias or ID of the calling radio on the display.



When you hear a repetitive tone and the LED blinks yellow, do one of the following:



- Press the **PTT** button while the display still shows the Call Alert in the Notification List to respond with a Private Call.
 - Press  to exit the Notification List. The alert is moved to the Missed Call Log.
-

Making a Call Alert from the Contact List

1  to access the menu.

2  or  to `Contacts` and press  to select.

3  or  to the required subscriber alias or ID and press  to select.

4  or  to `Call Alert` and press  to select.

The display shows `Call Alert` and the subscriber alias or ID, indicating that the Call Alert has been sent.

The LED lights up solid green when your radio is sending the Call Alert.

If the Call Alert acknowledgement is received, the display shows positive mini notice.

If the Call Alert acknowledgement is not received, the display shows negative mini notice.

Making a Call Alert with the One Touch Access Button

- Press the programmed **One Touch Access** button to make a Call Alert to the predefined alias or ID.

The display shows `Call Alert` and the subscriber alias or ID, indicating that the Call Alert has been sent.

The LED lights up solid green when your radio is sending the Call Alert.

If the Call Alert acknowledgement is received, the display shows positive mini notice.

If the Call Alert acknowledgement is not received, the display shows negative mini notice.

Emergency Operation

An Emergency Alarm is used to indicate a critical situation. You are able to initiate an Emergency at any time on any screen display even when there is activity on the current channel.

Your dealer can set the duration of a button press for the programmed **Emergency** button, except for long press, which is similar with all other buttons:

The **Emergency** button is assigned with the Emergency On/Off feature. Check with your dealer for the assigned operation of the **Emergency** button.

Note:

If the short press for the **Emergency** button is assigned to turn on the Emergency mode, then the long press for the **Emergency** button is assigned to exit the Emergency mode.

If the long press for the **Emergency** button is assigned to turn on the Emergency mode, then the short press for the **Emergency** button is assigned to exit the Emergency mode.

Your radio supports **three** Emergency Alarms:

- Emergency Alarm

- Emergency Alarm with Call
- Emergency Alarm with Voice to Follow



Note: Only **ONE** of the Emergency Alarms above can be assigned to the programmed **Emergency** button.

In addition, each alarm has the following types:

- **Regular** – Radio transmits an alarm signal and shows audio and/or visual indicators.
- **Silent** – Radio transmits an alarm signal without any audio or visual indicators. Radio receives calls without any sound through the radio's speaker, until you press the **PTT** button to initiate the call.
- **Silent with Voice** – Radio transmits an alarm signal without any audio or visual indicators, but allow incoming calls to sound through the radio's speaker.

Sending an Emergency Alarm

This feature allows you to send an Emergency Alarm, a non-voice signal, which triggers an alert indication on a group of radios.

If your radio is set to Silent, it will not display any audio or visual indicators during Emergency mode.

Press the programmed **Emergency On** button.

The display shows one of the following:

- Tx Alarm and the destination alias.
- Tx Telegram and the destination alias.

The LED lights up solid green and the Emergency icon appears on the Home screen display.

When an Emergency Alarm acknowledgement is received, the Emergency tone sounds and the LED blinks green. The display shows `Alarm Sent`.

If your radio does not receive an Emergency Alarm acknowledgement, and after all retries have been exhausted, a tone sounds and the display shows `Alarm Failed`.

Radio exits the Emergency Alarm mode and returns to the Home screen.

Sending an Emergency Alarm with Call

This feature allows you to send an Emergency Alarm to a group of radios. Upon acknowledgement by a radio within the group, the group of radios can communicate over a programmed Emergency channel.

If your radio is set to Silent, it will not display any audio or visual indicators during Emergency mode, or allow any received calls to sound through the radio's speaker, until you press the **PTT** button to initiate the call.

If your radio is set to Silent with Voice, it will not display any audio or visual indicators during Emergency mode, but allow incoming calls to sound through the radio's speaker. The indicators will only appear once you press the **PTT** button to initiate, or respond to, the call.

1 Press the programmed **Emergency On** button.

The display shows one of the following:

- Tx Alarm and the destination alias
- Tx Telegram and the destination alias

The LED lights up solid green.

When an Emergency Alarm acknowledgment is received, the Emergency tone sounds and the LED blinks green. The display shows `Alarm Sent`. Your radio enters the emergency call mode when the display shows `Emergency` and the destination group alias.

2 Hold the radio vertically 1 to 2 inches (2.5 to 5.0 cm) from your mouth.

3 Press **PTT** button to make the call. The LED lights up solid green and the Group icon appears on the display.

4 Wait for one of the following tones to finish (if enabled), and speak clearly into the microphone.

- the Talk Permit Tone
 -  the **PTT** Sidetone
-

5 Release the **PTT** button to listen.

 If the Channel Free Indication feature is enabled, you hear a short alert tone the moment the transmitting radio releases the **PTT** button, indicating the channel is free for you to respond.

6 Press the **PTT** button to respond.

7 Once your call ends, press **Emergency Off** button to exit the Emergency mode. The radio returns to the Home screen.

Sending an Emergency Alarm with Voice to Follow

This feature allows you to send an Emergency Alarm to a group of radios. Your radio's microphone is automatically activated, allowing you to communicate with the group of radios without pressing the **PTT** button.

This activated microphone state is also known as "hot mic".

If your radio has Emergency Cycle Mode enabled, repetitions of hot mic and receiving period are made for a programmed duration.

Note: During Emergency Cycle Mode, received calls sound through the radio's speaker.

If you press the **PTT** button during the programmed hot mic transmission or programmed receiving period, regardless whether Emergency Cycle Mode is enabled or disabled, you will hear a prohibit tone, indicating that you should release the **PTT** button. The radio ignores the **PTT** press and remains in Emergency mode.

Note: If you press the PTT button during hot mic, and continue to press it after the hot mic duration expires,

the radio continues to transmit until you release the PTT button.

If your radio is set to Silent, it will not display any audio or visual indicators during Emergency mode, or allow any received calls to sound through the radio's speaker, until the programmed hot mic transmission period is over, and you press the **PTT** button.

If your radio is set to Silent with Voice, it will not display any audio or visual indicators during Emergency mode when you are making the call with hot mic, but allow sound through the radio's speaker when the target radio responds after the programmed hot mic transmission period is over. The indicators will only appear when you press the **PTT** button.

Note: If the Emergency Alarm request fails, the radio does not retry to send the request, and enters the hot mic state directly.

- 1 Press the programmed **Emergency On** button.
The LED lights up solid green.

- 2 Once , speak clearly into the microphone.
When hot mic has been enabled, the radio automatically transmits without a **PTT** press until

the hot mic duration expires. While transmitting, the LED lights up solid green.

-
- Once the hot mic duration expires, the radio automatically stops transmitting. To transmit again, press the **PTT** button.
-

Reinitiating an Emergency Mode

Note: This feature is only applicable to the radio sending the Emergency Alarm.

There are two instances where this can happen:

- You change the channel while the radio is in Emergency mode. This exits the Emergency mode. If Emergency Alarm is enabled on this new channel, the radio reinitiates Emergency.
- You press the programmed **Emergency On** button during an Emergency initiation/transmission state. This causes the radio to exit this state, and to reinitiate Emergency.

Exiting Emergency Mode

Note: This feature is only applicable to the radio sending the Emergency Alarm.

Your radio exits Emergency mode when **one** of the following occurs:

- Emergency Alarm acknowledgement is received (for **Emergency Alarm** only)
- All retries to send the alarm have been exhausted
- The **Emergency Off** button is pressed.



Note:



If your radio is powered off, it exits the Emergency mode. The radio will not reinitiate the Emergency mode automatically when it is turned on again.

Text Message Features

Sending a Quick Text Message

-  to access the menu.

-  or  to Quick Text and press  to select.

-  or  to the required message . Press  to send.

The display shows transitional mini notice, confirming your message is being sent.

If the message is sent, a tone sounds and the display shows positive mini notice.

If the message is not sent, a low tone sounds and the display shows negative mini notice.

Sending a Quick Text Message with the One Touch Access Button

- Press the programmed **One Touch Access** button to send a predefined Quick Text message to a predefined alias or ID.

The display shows transitional mini notice, confirming your message is being sent.

If the message is sent, a tone sounds and the display shows positive mini notice.

If the message cannot be sent, a low tone sounds and the display shows negative mini notice.

If the text message fails to send, the radio returns you to the **Resend** option screen (see [Managing Fail-to-Send Text Messages](#) on page 62).

Managing Fail-to-Send Text Messages

You can select one of the following options while at the **Resend** option screen:

- Resend
- Forward



Resending a Text Message



- Press  to resend the same message to the same subscriber/group alias or ID.

If the message is sent successfully, a tone sounds and the display shows positive mini notice.

If the message cannot be sent, the display shows negative mini notice.

Forwarding a Text Message

- 1  or  to Forward and press  to select.

-
- 2  or  to the required alias or ID and press  to select.

The display shows transitional mini notice, confirming your message is being sent.

If the message is sent successfully, a tone sounds and the display shows positive mini notice.

If the message cannot be sent, a low tone sounds and the display shows negative mini notice.

Managing Sent Text Messages

Once a message is sent to another radio, it is saved in Sent Items. The most recent sent text message is always added to the top of the Sent Items list.





The Sent Items folder is capable of storing a maximum of thirty (30) last sent messages. When the folder is full, the next sent text message automatically replaces the oldest text message in the folder.



Note: Long press  at any time to return to the Home screen.



Viewing a Sent Text Message

- 1 Access the **Text Message** feature.

Radio Controls	Steps
Programmed Text Message button	Press the programmed Text Message button.

Radio Controls	Steps
Menu	<ol style="list-style-type: none"> 1  to access the menu. 2  or  to Messages and press  to select.

- 2  or  to Sent Items and press  to select.

- 3  or  to the required message and press  to select.

A subject line may be shown if the message is from an e-mail application.



The icon at the top right corner of the screen indicates the status of the message (see [Sent Item Icons](#) on page 25).

Sending a Sent Text Message

You can select one of the following options while viewing a sent text message:

- Resend
- Forward
- Delete

1 Press  again while viewing the message.

2  or  to one of the options described next and press  to select.

Option	Steps
Forward	Select Forward to send the selected text message to another subscriber/group alias or ID (see Forwarding a Text Message on page 62).
Delete	Select Delete to delete the text message.
Resend	Select Resend to resend the selected text message to the same subscriber/group alias or ID.

Option Steps



The display shows transitional mini notice, confirming that the same message is being sent to the same target radio.

If the message is sent successfully, a tone sounds and the display shows positive mini notice.

If the message cannot be sent, a low tone sounds and the display shows negative mini notice.

If the message fails to send, the radio returns you to the **Resend** option

screen. Press  to resend the message to the same subscriber/group alias or ID.

Note: Changing the volume, and pressing any button, except for , , or , returns you to the message.

Option	Steps
	<p>Note: The radio exits the Resend option screen if you press the PTT button to initiate a Private or Group Call, or to respond to a Group Call. The radio also exits the screen when it receives a text message, an emergency call or alarm, or a call alert.</p> <p>Note: The display returns to the Resend option screen if you press the PTT button to respond to a Private Call (except when the radio is displaying the Missed Call screen), and at the end of an All Call.</p>

If you exit the message sending screen while the message is being sent, the radio updates the status of the message in the Sent Items folder without providing any indication in the display or via sound.





If the radio changes mode or powers down before the status of the message in Sent Items is updated, the radio cannot complete any In-



Progress messages and automatically marks it with a Send Failed icon.

The radio supports a maximum of five (5) In-Progress messages at one time. During this period, the radio cannot send any new message and automatically marks it with a Send Failed icon.

Deleting All Sent Text Messages from Sent Items







- 1 Access the **Text Message** feature.

Radio Controls	Steps
Programmed Text Message button	Press the programmed Text Message button.
Menu	<ol style="list-style-type: none"> 1  to access the menu. 2  or  to Messages and press  to select.

- 2  or  to Sent Items and press  to select.

3  or  to Delete All and press  to select.

4 Choose one of the following.

-  or  to Yes and press  to select. The display shows positive mini notice.
-  or  to No and press  to return to the previous screen.

Receiving a Text Message

When your radio receives a message, the display shows the Notification List with the alias or ID of the sender and the Message icon .

You can select one of the following options when receiving a text message:



- Read?
- Read Later
- Delete



Note:

The radio exits the Text Message alert screen and sets up a Private or Group Call to the sender of the

message if the **PTT** button is pressed when the radio is displaying the alert screen.

Reading a Text Message

 or  to one of the options described next and press  to select.

Option	Steps
Read?	<p>Choosing this option, opens the selected message in the Inbox. A subject line may be shown if the message is from an e-mail application.</p> <p>Press  to return to the Inbox.</p> <p>Press  a second time to reply, forward, or delete the text message.</p>
Read Later	<p>Choosing this option, returns you to the screen you were on prior to receiving the text message.</p>

Option	Steps
Delete	Choosing this option, deletes the selected text message.

Managing Received Text Messages

Use the Inbox to manage your text messages. The Inbox is capable of storing a maximum of 30 messages.

Text messages in the Inbox are sorted according to the most recently received.



Your radio supports the following options for text messages:

- Forward
- Delete
- Delete All

Note: Long press  at any time to return to the Home screen.

Viewing a Text Message from the Inbox

- 1  to access the menu.



- 2  or  to Messages and press  to select.

- 3  or  to Inbox and press  to select.

- 4  or  to view the messages.





A subject line may be shown if the message is from an e-mail application.

- 5 Do one of the following:



- Press  to select the current message, and press  again to reply, forward, or delete that message.
- Long press  to return to the Home screen.

Deleting a Text Message from the Inbox

- 1 Access the **Text Message** feature.



Radio Controls	Steps
Programmed Text Message button	Press the programmed Text Message button.
Menu	<ol style="list-style-type: none"> 1  to access the menu. 2  or  to Messages and press  to select.



2  or  to **Inbox** and press  to select.

3  or  to the required message and press  to select.

A subject line may be shown if the message is from an e-mail application.





4 Press  once more to access the sub-menu.



5  or  to **Delete** and press  to select.

6  or  to **Yes** and press  to select. The display shows positive mini notice and the screen returns to the **Inbox**.

Deleting All Text Messages from the Inbox



1 Access the **Text Message** feature.



Radio Controls	Steps
Programmed Text Message button	Press the programmed Text Message button.
Menu	<ol style="list-style-type: none"> 1  to access the menu. 2  or  to Messages and press  to select.

2  or  to **Inbox** and press  to select.

When you select **Inbox** and it contains no text messages, the display shows **List Empty**.

3  or  to **Delete All** and press  to select.

4  or  to **Yes** and press  to select.
The display shows positive mini notice.

4  or  to the required message. Press  to send.

The display shows transitional mini notice, confirming your message is being sent.

If the message is sent, a tone sounds and the display shows positive mini notice.



If the message is not sent, a low tone sounds and the display shows negative mini notice.



Analog Message Encode

Your radio is able to send pre-programmed messages from the Message list to a radio alias or to the dispatcher.

Sending MDC Message Encode to Dispatcher



1  to access the menu.



2  or  to **Message** and press  to select.



3  or  to **Quick Text** and press  to select.



Sending 5-Tone Message Encode to Contact

1  to access the menu.

2  or  to **Message** and press  to select.

3  or  to **Quick Text** and press  to select.



4  or  to the required message. Press  to select.



- 5  or  to the required contact. Press  to select.

The display shows transitional mini notice, confirming your message is being sent.

If the message is sent, a tone sounds and the display shows positive mini notice.

If the message is not sent, a low tone sounds and the display shows negative mini notice.

- 2  or  to the required status and press  to select.

- 3  or  to Set as Default and press  to select.

The display shows transitional mini notice, confirming your status update is being sent.

If the status update is acknowledged, a tone sounds and the display shows positive mini notice. A ✓ appears beside the acknowledged status.

If the status update is not acknowledged, a low tone sounds and the display shows negative mini notice. A ✓ remains beside the previous status.

For 5-Tone systems, see for details on setting the default contact.



For 5-Tone systems, a **PTT** button press while in the status list sends the selected status update and returns to the Home screen to initiate a voice call.

Analog Status Update

Your radio is able to send preprogrammed messages from the Status List indicating your current activity to a radio contact (for 5-Tone systems) or to the dispatcher (for MDC systems).

The last acknowledged message is kept at the top of the Status List. The other messages are arranged in alphanumeric order.



Sending Status Update to Predefined Contact



- 1  or  to Status and press  to select.

Viewing a 5-Tone Status Details

Note: A Software License Key sold separately is required to use this feature.

1  or  to `Status` and press  to select.

2  or  to the required status and press  to select.

3  or  to `View Details` and press  to select.
The display shows details of the selected status.

- Basic Privacy
- Enhanced Privacy.

Only **ONE** of the privacy types above can be assigned to the radio.

To unscramble a privacy-enabled call or data transmission, your radio must be programmed to have the same Privacy Key (for Basic Privacy), OR the same Key Value and Key ID (for Enhanced Privacy) as the transmitting radio.

If your radio receives a scrambled call that is of a different Privacy Key, OR a different Key Value and Key ID, you will either hear a garbled transmission (Basic Privacy) or nothing at all (Enhanced Privacy).

If the radio has a privacy type assigned, the Home screen shows the Secure or Unsecure icon, except when the radio is sending or receiving an Emergency call or alarm.

The LED lights up solid green while the radio is transmitting and blinks green rapidly when the radio is receiving an ongoing privacy-enabled transmission.

You can access this feature by

- Pressing the programmed **Privacy** button to toggle privacy on or off.

Privacy

If enabled, this feature helps to prevent eavesdropping by unauthorized users on a channel by the use of a software-based scrambling solution. The signaling and user identification portions of a transmission are not scrambled.



Your radio must have privacy enabled on the channel to send a privacy-enabled transmission, although this is not a necessary requirement for receiving a transmission. While on a privacy-enabled channel, the radio is still able to receive clear (unscrambled) transmissions.



Your radio supports two types of privacy:



- Using the Radio Menu as described by the steps described next.

Note: Some radio models may not offer this Privacy feature. Check with your dealer or system administrator for more information.

1  to access the menu.

2  or  to Utilities and press  to select.

3  or  to Radio Settings and press  to select.

4  or  to Privacy and press  to select.

You can also use  or  to change selected option.

5 Press  to enable/disable Privacy.

The display shows ✓ beside Enabled.

The ✓ disappears from beside Enabled.



Security











You can enable or disable any radio in the system. For example, you might want to disable a stolen radio, to prevent the thief from using it, and enable that radio, when it is recovered.







Note: Performing Radio Disable and Enable is limited to radios with these functions enabled. Check with your dealer or system administrator for more information.

Radio Disable

1 Access this feature by

Radio Controls	Steps
Radio Disable button	1 Press the programmed Radio Disable button.
	2  or  to the required alias or ID and press  to select.

Radio Controls	Steps
Radio menu	<ol style="list-style-type: none"> 1  to access the menu. 2  or  to <code>Contacts</code> and press  to select. The entries are alphabetically sorted. 3 Use one of the steps described next to select the required subscriber alias or ID <ul style="list-style-type: none"> • select the required alias or ID directly <ul style="list-style-type: none"> •  or  to the required alias or ID and press  to select. • use the <code>Manual Dial</code> menu <ul style="list-style-type: none"> •  or  to <code>Manual Dial</code> and press  to select.

Radio Controls	Steps
	<ul style="list-style-type: none"> •  or  to <code>Radio Number</code> and press  to select. • The first line of the display shows <code>Radio Number: .</code> the second line of the display shows a blinking cursor. Use the keypad to enter the subscriber alias or ID and press . <ol style="list-style-type: none"> 4  or  to <code>Radio Disable</code> and press  to select.

The display shows `Radio Disable:`
`<Subscriber Alias or ID>` and the LED lights up solid green.







- 2 Wait for acknowledgment.
If successful,

If not successful,

Do not press  during the Radio Disable operation as you will not get an acknowledgement message.









Radio Enable





1 Access this feature by

Radio Controls	Steps
Radio Enable button	<ol style="list-style-type: none">1 Press the programmed Radio Enable button.2  or  to the required alias or ID and press  to select.
Radio menu	<ol style="list-style-type: none">1  to access the menu.2  or  to Contacts and press  to select. The entries are alphabetically sorted.

Radio Controls

Steps

- 3 Use one of the steps described next to select the required subscriber alias or ID
 - select the required alias or ID directly
 -  or  to the required alias or ID and press  to select.
 - use the Manual Dial menu
 -  or  to Manual Dial and press  to select.
 -  or  to Radio Number and press  to select.

Radio Controls	Steps
	<ul style="list-style-type: none"> The first line of the display shows Radio Number: . the second line of the display shows a blinking cursor. Use the keypad to enter the subscriber alias or ID and press .
	<p>4  or  to Radio Enable and press  to select.</p>

The display shows Radio Enable: <Subscriber Alias or ID> and the LED lights up solid green.

2 Wait for acknowledgment.

If successful,

If not successful,

Do not press  during the Radio Enable operation as you will not get an acknowledgement message.

Lone Worker

This feature raises an emergency if there is no user activity, such as any radio button press or activation of the channel selector, for a predefined time.

Before raising the emergency, when the inactivity timer expires, the radio warns the user via an audio indicator.

If there is still no acknowledgment by the user before the predefined reminder timer expires, the radio initiates an Emergency Alarm.

Only **one** of the following Emergency Alarms can be assigned to this feature:

- Emergency Alarm
- Emergency Alarm with Call
- Emergency Alarm with Voice to Follow 





The radio remains in the emergency state allowing voice messages to proceed until action is taken. See [Emergency Operation](#) on page 57 on ways to exit Emergency.

Note: This feature is limited to radios with this function enabled. Check with your dealer or system administrator for more information.

Password Lock Features

If enabled, this feature only allows you access your radio if the correct password is entered upon powering up.

Accessing the Radio from Password

- 1 Power up your radio.
You hear a continuous tone.
-
- 2 Enter your current four-digit password. Press or to edit each digit's numeric value. Each digit changes to ●. Press to move to next digit. Press  to confirm your selection.
 - Enter your current four-digit password with the radio's keypad. The second line of the display shows ●●●●. Press  to proceed.
 - Enter your current four-digit password. Press  or  to edit each digit's numeric value. Each digit changes to ●. Press to move to next digit. Press  to confirm your selection.

You hear a positive indicator tone for every digit entered. Press to remove the last digit on the display.

If the password is correct, your radio proceeds to power up. See [Powering Up the Radio](#) on page 16.

If the password is incorrect, the display shows `Wrong Password`. Repeat Steps 1 on page 76 and 2 on page 76.

After the third incorrect password, the display shows `Wrong Password` and then, shows `Radio Locked`. A tone sounds and the LED double blinks yellow.

Your radio enters into locked state for 15 minutes, and responds to inputs from **On/Off/Volume Control Knob** only.

Note:

The radio is unable to receive any call, including emergency calls, in locked state.

Unlocking the Radio from Locked State

- 1 If your radio was powered down after being in the locked state, power up the radio.



A tone sounds and the LED double blinks yellow.
The display shows `Radio Locked`.



- 2 Wait for 15 minutes.
Your radio restarts the 15 minutes timer for locked state when you power up.



- 3 Repeat Steps 1 on page 76 and 2 on page 76 in [Accessing the Radio from Password](#) on page 76.

Turning the Password Lock On or Off

- 1  to access the menu.

- 2  or  to `Utilities` and press  to select.

- 3  or  to `Radio Settings` and press  to select.

- 4  or  to `Passwd Lock` and press  to select.

- 5 Enter the four-digit password.



See Step 2 on page 76 in [Accessing the Radio from Password](#) on page 76.



- 6 Press  to proceed.
If the password is incorrect, the display shows `Wrong Password`, and automatically returns to the previous menu.



 - 7 If the password entered in the previous step is correct, press  to enable/disable password lock.
The display shows ✓ beside `Enabled`.
The ✓ disappears from beside `Enabled`.
-

Changing the Password

- 1  to access the menu.



 - 2  or  to `Utilities` and press  to select.
-

- 3  or  to Radio Settings and press  to select.

- 4  or  to Passwd Lock and press  to select.

- 5 Enter the four-digit password.
See Step 2 on page 76 in [Accessing the Radio from Password](#) on page 76.

- 6 Press  to proceed.
If the password is incorrect, the display shows Wrong Password, and automatically returns to the previous menu.

- 7 If the password entered in the previous step is correct,  or  to Change Pwd and press  to select.

- 8 Enter a new four-digit password.
See Step 2 on page 76 in [Accessing the Radio from Password](#) on page 76.

- 9 Reenter the previously entered four-digit password. See Step 2 on page 76 in [Accessing the Radio from Password](#) on page 76.
-

- 10 Press  to proceed.

If the reentered password matches the new password entered earlier, the display shows Password Changed.

If the reentered password does **NOT** match the new password entered earlier, the display shows Passwords Do Not Match.

The screen automatically returns to the previous menu.

Notification List

Your radio has a Notification List that collects all your “unread” events on the channel, such as unread text messages, missed calls, and call alerts.



The Notification icon appears on the status bar when the Notification List has one or more events.



The list supports a maximum of forty (40) unread events. When it is full, the next event automatically replaces the oldest event.

Note: After the events are read, they are removed from the Notification List.

Accessing the Notification List

- 1  to access the menu.

- 2  or  to Notification and press  to select.

- 3  or  to the required event and press  to select.

Long press  to return to the Home Screen.

Auto-Range Transponder System (ARTS)

ARTS is an analog-only feature designed to inform you when your radio is out-of-range of other ARTS-equipped radios.

ARTS-equipped radios transmit or receive signals periodically to confirm that they are within range of each other. Your dealer can program your radio to transmit or receive the ARTS signal.

Your radio provides indications of states as follows:

- **First-Time Alert**– A tone sounds and the display shows *In Range* after the channel alias.
- **ARTS-in-Range Alert** – A tone sounds, if programmed, and the display shows *In Range* after the channel alias.
- **ARTS-Out-of-Range Alert** – A tone sounds, the LED rapidly blinks red, and the display alternates between *Out of Range* and the home screen.

Over-the-Air-Programming (OTAP)

Your radio can be updated by your dealer remotely, via OTAP, without needing to be physically connected. Additionally, some settings can also be configured via OTAP.

While undergoing OTAP, the LED blinks green.

Note: When the radio is receiving high volume data, the High Volume Data icon appears and channel is

busy. A PTT button press at this time may cause a negative tone to sound.

Once the programming is complete, depending on your radio's configuration:

- A tone sounds, the display shows `Updating`
`Restarting`, and your radio restarts (powers off and on again).
- Select between `Restart Now` or `Postpone`.
Selecting `Postpone` allows your radio to return to the previous display, with an OTAP Timer icon visible, for a period of time before the automatic restart occurs.

Upon power up after the automatic restart occurs, the display shows `Sw Update Completed` if the OTAP update is successful or `Sw Update Failed` if the OTAP update is unsuccessful.

See [Software Update](#) on page 94 for your updated software version.

Utilities



Setting the Squelch Level



You can adjust your radio's squelch level to filter out unwanted calls with low signal strength or channels that have a higher than normal background noise.



Normal is the default. Tight filters out (unwanted) calls and/or background noise; however, calls from remote locations may also be filtered out.



Press the programmed **Squelch** button to toggle squelch level between normal and tight. Follow the procedure described next to access this feature via the radio's menus.

- 1  to access the menu.

- 2  or  to `Utilities` and press  to select.

- 3  or  to `Radio Settings` and press  to select.

- 4  or  to `Squelch` and press  to select.
The display shows `Tight` and `Normal`.





- 5  or  to the required setting and press  to select.
✓ appears besides selected setting. Screen returns to the previous menu.



Setting the Power Level



You can customize your radio's power setting to high or low for each channel.





High enables communication with radios located at a considerable distance from you. Low enables communication with radios in closer proximity.

Press the programmed **Power Level** button to toggle transmit power level between high and low. Follow the procedure described next to access this feature via the radio's menus.

- 1  to access the menu.
-
- 2  or  to `Utilities` and press  to select.

- 3  or  to `Radio Settings` and press  to select.

- 4  or  to `Power` and press  to select.

- 5  or  to the required setting and press  to select.
✓ appears beside selected setting. At any time, long press  to return to the Home screen. Screen returns to the previous menu.

Adjusting the Display Brightness

You can adjust radio's display brightness as needed.

Note: Display brightness cannot be adjusted when "Auto Brightness" is enabled.

Adjust the Display Brightness











Radio Control Steps

- | | |
|---------------------------|---|
| Programmed Display | 1 Press the programmed Brightness button. |
|---------------------------|---|

Radio Control Steps

Brightness Button **2** Decrease display brightness by pressing or increase the display brightness by pressing . Select from setting of 1 to 8. Press  to confirm your entry.

Menu

- 1**  to access the menu.
- 2**  or  to Utilities and press  to select.
- 3**  or  to Radio Settings and press  to select.
- 4**  or  to Brightness and press  to select.
The display shows a progress bar.

Radio Control Steps

- 5** Decrease display brightness by pressing or increase the display brightness by pressing . Select from setting of 1 to 8. Press  to confirm your entry.

Turning the Voice Operating Transmission (VOX) Feature On or Off

This feature allows you to initiate a hands-free voice activated call on a programmed channel. The radio automatically transmits, for a programmed period, whenever the microphone on the VOX-capable accessory detects voice.

Pressing the **PTT** button during radio operation will disable VOX. To re-enable VOX, do one of the following:



- Turn the radio off and power it on again
- Change the channel via the Channel Selector Knob
- Press the programmed **VOX** button to toggle the feature on or off



or follow the steps described next to access this feature via the radio menu.



If the Talk Permit Tone feature is enabled (see *Turning the Talk Permit Tone On or Off* on page 85), use a trigger word to initiate the call. Wait for the Talk Permit Tone to finish before speaking clearly into the microphone.



Note: Turning this feature on or off is limited to radios with this function enabled. Check with your dealer or system administrator for more information.

1  to access the menu.

2  or  to *Utilities* and press  to select.

3  or  to *Radio Settings* and press  to select.

4  or  to *VOX* and press  to select.

You can also use  or  to change the selected option.

5 Press  to disable/enable VOX.

The display shows ✓ beside Enabled.



The ✓ disappears from beside Enabled.



Turning the Radio Tones/Alerts On or Off

You can enable and disable all radio tones and alerts (except for the incoming Emergency alert tone) if needed.



Press the programmed **All Tones/Alerts** button to toggle all tones on or off, or follow the procedure described next to access this feature via the radio menu.



1  to access the menu.

2  or  to *Utilities* and press  to select.

3  or  to *Radio Settings* and press  to select.

4  or  to Tones/Alerts and press  to select.

5  or  to All Tones and press  to select.

You can also use  or  to change the selected option.

6 Press  to enable/disable all tones and alerts.



The display shows ✓ beside Enabled.



The ✓ disappears from beside Enabled.

Turning the Power Up Alert Tone On or Off

You can enable and disable the Power Up Alert Tone if needed.



1  to access the menu.

2  or  to Utilities and press  to select.

3  or  to Radio Settings and press  to select.

4  or  to Tones/Alerts and press  to select.

5  or  to Power Up and press  to select.

You can also use  or  to change the selected option.

6 Press  to enable/disable the Power Up Alert Tone.



The display shows ✓ beside Enabled.



The ✓ disappears from beside Enabled.



Setting the Tone Alert Volume Offset Level



You can adjust the Tone Alert Volume Offset level if needed. This feature adjusts the volume of the tones/alerts, allowing it to be higher or lower than the voice volume.



- 1  to access the menu.

- 2  or  to Utilities and press  to select.

- 3  or  to Radio Settings and press  to select.

- 4  or  to Tones/Alerts and press  to select.

- 5  or  to Vol. Offset and press  to select.

- 6  or  to the required volume value.
The radio sounds a feedback tone with each corresponding volume value.



- 7 Do one of the following:
 - Press  to keep the required displayed volume value.



- Press  to exit without changing the current volume offset settings.
- Repeat Step 6 on page 85 to select another volume value.



Turning the Talk Permit Tone On or Off



You can enable and disable the Talk Permit Tone if needed.

- 1  to access the menu.

- 2  or  to Utilities and press  to select.

- 3  or  to Radio Settings and press  to select.

- 4  or  to Tones/Alerts and press  to select.











- 5  or  to Talk Permit and press  to select.

You can also use  or  to change the selected option.



- 6 Press  to enable/disable the Talk Permit Tone.
The display shows ✓ beside Enabled.
The ✓ disappears from beside Enabled.
-

Language

You can set your radio display to be in your required language.











- 1  to access the menu.
 - 2  or  to Utilities and press  to select.
 - 3  or  to Radio Settings and press  to select.
 - 4  or  to Languages and press  to select.
-



You can also use  or  to change selected option.

- 5  or  to the required language and press  to enable. ✓ appears beside selected language.
-

Turning the LED Indicator On or Off

You can enable and disable the LED Indicator if needed.



- 1  to access the menu.
 - 2  or  to Utilities and press  to select.
 - 3  or  to Radio Settings and press  to select.
 - 4  or  to LED Indicator and press  to select.
-

You can also use  or  to change the selected option.

- 5 Press  to enable/disable the LED Indicator.

The display shows ✓ beside Enabled.

The ✓ disappears from beside Enabled.

- 5  or  to Intro Screen and press  to select.

You can also use  or  to change the selected option.

- 6 Press  to enable/disable the Introduction Screen.



The display shows ✓ beside Enabled.



The ✓ disappears from beside Enabled.



Turning the Introduction Screen On or Off

You can enable and disable the Introduction Screen if needed.

- 1  to access the menu.
-

- 2  or  to Utilities and press  to select.
-













- 3  or  to Radio Settings and press  to select.
-



- 4  or  to Display and press  to select.
-

Voice Announcement

This feature enables the radio to audibly indicate the current Zone or Channel the user has just assigned, or programmable button press. This audio indicator can be customized per customer requirements. This is typically useful when the user is in a difficult condition to read the content shown on the display.





Toggle Voice Announcement On or Off.



Radio Control	Steps
Programmed Voice Announcement Button	Press the programmed Voice Announcement button.
Menu	<p>1  to access the menu.</p> <p>2  or  to Utilities and press  to select.</p> <p>3  or  to Radio Settings and press  to select.</p> <p>4  or  to Voice Announcement and press  to select.</p> <p>Note: You can also use  or  to change the selected option.</p>

Radio Control	Steps
	<p>5 Do one of the following:</p> <ul style="list-style-type: none"> Press  to enable Voice Announcement. The display shows ✓ beside Enabled. Press  to disable Voice Announcement. The ✓ disappears from beside Enabled.

Call Forwarding



You can enable your radio to automatically forward voice calls to another radio.

-  to access the menu.
-  or  to Utilities and press  to select.

3  or  to Call Forward and press  to select.

You can also use  or  to change the selected option.



4 Do one of the following:



- Press  to enable Call Forwarding. The display shows ✓ beside Enabled.
- Press  to disable Call Forwarding. The ✓ disappears from beside Enabled.



Menu Timer



Set the period of time your radio stays in the menu before it automatically switches to the Home screen.



1  to access the menu.

2  or  to Utilities and press  to select.

3  or  to Radio Settings and press  to select.

4  or  to Display and press  to select.



5  or  to Menu Timer and press  to select.



6  or  to the required setting and press  to select.



Analog Mic AGC (Mic AGC-A)



This feature controls the your radio's microphone gain automatically while transmitting on an analog system. It suppresses loud audio or boosts soft audio to a preset value in order to provide a consistent level of audio.

1  to access the menu.



2  or  to Utilities and press  to select.

3  or  to Radio Settings and press  to select.

You can also use  or  to change the selected option.

4  or  to Analog Mic AGC and press  to select.

5 Do one of the following:



- Press  to enable Analog Mic AGC. The display shows ✓ beside Enabled.
 - Press  to disable Analog Mic AGC. The ✓ disappears from beside Enabled.
-



Digital Mic AGC (Mic AGC-D)

This feature controls the your radio's microphone gain automatically while transmitting on a digital system. It suppresses loud audio or boosts soft audio to a



preset value in order to provide a consistent level of audio.

1  to access the menu.



2  or  to Utilities and press  to select.

3  or  to Radio Settings and press  to select.

You can also use  or  to change the selected option.

4  or  to Digital Mic AGC and press  to select.







5 Do one of the following:

- Press  to enable Digital Mic AGC. The display shows ✓ beside Enabled.
 - Press  to disable Digital Mic AGC. The ✓ disappears from beside Enabled.
-



Intelligent Audio

Your radio can automatically adjust its audio volume to overcome background noise in the environment, inclusive of all stationary and non-stationary noise sources. This feature is a Receive-only feature and does not affect Transmit audio.

Toggle Intelligent Audio On or Off.



Radio Control Steps	
Programmed Intelligent Audio Button	Press the programmed Intelligent Audio button.
Menu	<ol style="list-style-type: none"> 1  to access the menu. 2  or  to Radio Settings and press  to select. 3  or  to Radio Settings and press  to select.

Radio Control Steps

- 4  or  to Intelligent Audio and press  to select.

Note: You can also use

 or  to change the selected option.

- 5 Do one of the following:
 - Press  to enable Intelligent Audio. The display shows ✓ beside Enabled.
 - Press  to disable Intelligent Audio. The ✓ disappears from beside Enabled.

Turning the Acoustic Feedback Suppressor Feature On or Off







This feature allows you to minimize acoustic feedback in received calls.

Toggle Acoustic Feedback Suppressor Features On or Off



Radio Control Steps

Programmed Acoustic Feedback Suppressor Button Press the programmed **Acoustic Feedback Suppressor** button.

Menu

- 1  to access the menu.
- 2  or  to Utilities and press  to select.
- 3  or  to Radio Settings and press  to select.

Radio Control Steps



- 4  or  to AF

Suppressor and press  to select.

Note: You can also use

 or  to change the selected option.



- 5 Do one of the following:

- Press  to enable Acoustic Feedback Suppressor. The display shows ✓ beside Enabled.
- Press  to disable Acoustic Feedback Suppressor. The ✓ disappears from beside Enabled.

Accessing General Radio Information

Your radio contains information on the following:



- Battery
- Radio Alias and ID
- Firmware and Codeplug Versions
- Software Update



Press  at any time to return to the previous screen or long press  to return to the Home screen. The radio exits the current screen once the inactivity timer expires.



Accessing the Battery Information

Displays information on your radio battery.

- 1  to access the menu.

- 2  or  to Utilities and press  to select.

- 3  or  to Radio Info and press  to select.

- 4  or  to Battery Info and press  to select.

The display shows the battery information.

For **IMPRES** batteries **ONLY**: The display reads **Recondition Battery** if the battery requires reconditioning in an IMPRES charger. After the reconditioning process, the display then shows the battery information.



Checking the Radio Alias and ID



This feature displays the ID of your radio.



Press the programmed **Radio Alias and ID** button to check your radio alias and ID. You hear a positive indicator tone.

Follow the procedure described next to access this feature via the radio screen.

- 1  to access the menu.

- 2  or  to Utilities and press  to select.











- 3  or  to Radio Info and press  to select.

- 4  or  to My ID and press  to select.
The first line of the display shows the radio alias.
The second line of the display shows the radio ID.

*You can also press the programmed **Radio Alias and ID** button to return to the previous screen.*

Checking the Firmware Version and Codeplug Version











Displays the firmware version on your radio.

- 1  to access the menu.
-
- 2  or  to Utilities and press  to select.
-
- 3  or  to Radio Info and press  to select.
-
- 4  or  to Versions and press  to select.
The display shows the current firmware and codeplug versions.

Software Update

Displays the date and time of the latest software update carried out via Over-the-Air Programming.



Note: Software Update menu is only available after at least one successful OTAP session.

- 1  to access the menu.
-
- 2  or  to Utilities and press  to select.
-
- 3  or  to Radio Info and press  to select.
-
- 4  or  to SW Update and press  to select.
The display shows the date and time of the latest software update.

See [Over-the-Air-Programming \(OTAP\)](#) on page 79 for details on OTAP session.

RSSI Values

Your radio shows the Received Signal Strength Indicator (RSSI) icon at the top of your display. This feature allows you to view the RSSI values.

On the home screen, press  three times and immediately press , all within 5 seconds. The display shows current RSSI values. Long press the  to return to the Home Screen.



See [Display Icons](#) on page 22 for details on RSSI icon.



Front Panel Programming (FPP)

Your radio is able to customize certain feature parameters to enhance the use of your radio.

Entering FPP Mode

- 1  to access the menu.





- 2  or  to Utilities and press  to select.

- 3  or  to Program Radio and press  to select.

Long press  at any time to return to the Home screen.

Editing FPP Mode Parameters

Use the following buttons as required while navigating through the feature parameters:

- ,  - Scroll through options, increase/decrease values, or navigate vertically.
-  - Select the option or enter a sub-menu.
-  - Short-press to return to previous menu or to exit the selection screen. Long-press to return to Home screen.

Accessories

Antennas

- 480 – 527 MHz Stubby Antenna Kit, (PMAE4092_)
- VHF, 136 – 155MHz, Helical Antenna (PMAD4117_)
- VHF, 144 – 165MHz, Helical Antenna (PMAD4116_)
- VHF, 152 – 174MHz, Helical Antenna (PMAD4118_)
- VHF, 136 – 148MHz, Stubby Antenna (PMAD4119_)
- VHF, 146 – 160MHz, Stubby Antenna (PMAD4120_)
- VHF, 360 – 400MHz, Stubby Antenna (PMAD4133_)
- VHF, 350 – 380MHz, Stubby Antenna (PMAD4136_)
- UHF, 403 – 450MHz, Stubby Antenna (PMAE4069_)

- UHF, 440 – 490MHz, Stubby Antenna (PMAE4070_)
- UHF, 470 – 527MHz, Stubby Antenna (PMAE4071_)
- UHF, 403 – 527MHz, Slim Whip Antenna (PMAE4079_)
- VHF, 350 – 400MHz, Whip Antenna (PMAD4139_)

Batteries

- Core NiMH, 1300mAh IP56 Battery (PMNN4415_)
- Core Slim Li-Ion, 1500mAh IP56 Battery (PMNN4416_)^[3]
- IMPRES Li-Ion Slim, 1500mAh IP56 Battery (PMNN4417_)^[3]
- IMPRES Li-Ion Non-FM, 2150mAh IP56 Battery (PMNN4418_)^[3]

Carry Devices

- Belt Clip for 2-Inch Belt Width (PMLN4651_)
- Belt Clip for 2.5-Inch Belt Width (PMLN7008_)
- 2.5-Inch Replacement Leather Swivel Belt Loop (PMLN5610_)
- 3-Inch Replacement Leather Swivel Belt Loop (PMLN5611_)
- Hard Leather Carry Case with 3-Inch Fixed Belt Loop for Limited Keypad Radio (PMLN5863_)
- Hard Leather Carry Case with 3-Inch Swivel Belt for Limited Keypad Radio (PMLN5865_)
- Hard Leather Carry Case with 2.5-Inch Swivel Belt Loop for Limited Keypad Radio (PMLN5867_)
- Nylon Carry Case with 3-Inch Fixed Belt Loop for Limited Keypad Radio (PMLN5869_)

Chargers

- IMPRES Vehicular Charger (NNTN7616_)
- IMPRES Multi-Unit Charger, Euro Plug (WPLN4213_)
- IMPRES Multi-Unit Charger, UK Plug (WPLN4214_)

- IMPRES Multi-Unit Charger, Argentina Plug (WPLN4216_)
- IMPRES Multi-Unit Charger with Display, Euro Plug (WPLN4220_)
- IMPRES Multi-Unit Charger with Display, UK Plug (WPLN4221_)
- IMPRES Multi-Unit Charger with Display, Argentina Plug (WPLN4223_)
- IMPRES Single-Unit Charger, Base Only (WPLN4226_)
- IMPRES Single-Unit Charger with Switch Mode Power Supply (WPLN4232_)
- IMPRES Single-Unit Charger, Euro Plug (WPLN4234_)
- IMPRES Single-Unit Charger, Argentina Plug (WPLN4236_)
- IMPRES Single-Unit Charger (WPLN4255_)
- IMPRES Multi-Unit Charger with Display Base Only (WPLN4218_)
- IMPRES Single-Unit Charger (WPLN4256_)
- IMPRES Multi-Unit Charger with Display Base Only (WPLN4218_)
- Assembly, Accessory, LTD SUC IMPRESS SMPS Euro (WPLN4255_)

- IMPRES Single Unit Charger, Brazil Plug (WPLN4281_)
- Single Unit Charger, Euro Plug (NNTN8273_)
- Single Unit Charger, Argentina Plug (NNTN8225_)
- Single Unit Charger, Brazil Plug (NNTN8280_)

Earbuds and Earpieces

- Receive-Only Covered Earbud with Coiled Cord, for Remote Speaker Microphone (AARLN4885_)
- D-Shell Receive-Only Earpiece (One Size) for Remote Speaker Microphone (PMLN4620_)
- Receive-Only Earpiece with Translucent Tube and Rubber Eartip for Remote Speaker Microphone (RLN4941_)
- Receive-Only Flexible Earpiece for Remote Speaker Microphone (WADN4190_)
- Earbud with In-Line Mic/PTT, MagOne (PMLN5733_)
- Earpiece In-Line Mic/PTT Swivel, MagOne (PMLN5727_)
- Earset with Boom Microphone, MagOne (PMLN5732_)

Headsets and Headset Accessories

- Heavy Duty Headset, Noise Cancelling with In-Line PTT (PMLN5731_)

Remote Speaker Microphones

- IMPRES Remote Speaker Microphone Large, Noise Cancelling with 3.5mm Jack (PMMN4071_)
- IMPRES Remote Speaker Microphone Small, with 3.5mm Jack (PMMN4073_)
- Remote Speaker Microphone Small, No Emergency, IP57 (PMMN4075_)
- Remote Speaker Microphone Small with 3.5mm Jack (PMMN4076_)

Surveillance Accessories

- 2-Wire Surveillance Kit, Black (PMLN5724_)
- 2-Wire Surveillance Kit, Beige (PMLN5726_)

Miscellaneous Accessories

- Adjustable Black Nylon Carrying Strap (Attaches to D-Ring on Carry Case) (NTN5243_)
- Universal Chest Pack (HLN6602_)

- Waterproof Bag, Includes Large Carry Strap (HLN9985_)
- Shoulder Strap (Attaches to D-Rings on Carry Case) (NTN5243_)
- Small Clip, Epaulet Strap (RLN4295_)
- Break-A-Way Chest Pack (RLN4570_)
- Universal RadioPAK and Utility Case (Fanny Pack) (RLN4815_)
- Replacement Strap for RLN4570_ and HLN6602_ (1505596Z02)
- Universal RadioPAK Extension Belt (4280384F89)
- 1.75 Inch Wide Leather Belt (4200865599)

Batteries and Chargers Warranty

The Workmanship Warranty

The workmanship warranty guarantees against defects in workmanship under normal use and service.

All MOTOTRBO Batteries	Two (2) Years
IMPRES Chargers (Single-Unit and Multi-Unit, Non-Display)	Two (2) Years
IMPRES Chargers (Multi-Unit with Display)	One (1) Year

The Capacity Warranty

The capacity warranty guarantees 80% of the rated capacity for the warranty duration.

Nickel Metal-Hydride (NiMH) or Lithium-Ion (Li-Ion) Batteries	12 Months
---	-----------

IMPRES Batteries, When Used Exclusively with IMPRES Chargers 18 Months

Limited Warranty

MOTOROLA COMMUNICATION PRODUCTS

I. WHAT THIS WARRANTY COVERS AND FOR HOW LONG:

MOTOROLA SOLUTIONS, INC. (“MOTOROLA”) warrants the MOTOROLA manufactured Communication Products listed below (“Product”) against defects in material and workmanship under normal use and service for a period of time from the date of purchase as scheduled below:

DGP Series Digital Portable Radios	Two (2) Years
Product Accessories (Excluding Batteries and Chargers)	One (1) Year

MOTOROLA, at its option, will at no charge either repair the Product (with new or reconditioned parts), replace it (with a new or reconditioned Product), or refund the purchase price of the Product during the

warranty period provided it is returned in accordance with the terms of this warranty. Replaced parts or boards are warranted for the balance of the original applicable warranty period. All replaced parts of Product shall become the property of MOTOROLA.

This express limited warranty is extended by MOTOROLA to the original end user purchaser only and is not assignable or transferable to any other party. This is the complete warranty for the Product manufactured by MOTOROLA. MOTOROLA assumes no obligations or liability for additions or modifications to this warranty unless made in writing and signed by an officer of MOTOROLA.

Unless made in a separate agreement between MOTOROLA and the original end user purchaser, MOTOROLA does not warrant the installation, maintenance or service of the Product.

MOTOROLA cannot be responsible in any way for any ancillary equipment not furnished by MOTOROLA which is attached to or used in connection with the Product, or for operation of the Product with any ancillary equipment, and all such equipment is expressly excluded from this warranty. Because each system which may use the Product is unique, MOTOROLA disclaims liability for range, coverage, or

operation of the system as a whole under this warranty.

II. GENERAL PROVISIONS:

This warranty sets forth the full extent of MOTOROLA'S responsibilities regarding the Product. Repair, replacement or refund of the purchase price, at MOTOROLA's option, is the exclusive remedy. THIS WARRANTY IS GIVEN IN LIEU OF ALL OTHER EXPRESS WARRANTIES. IMPLIED WARRANTIES, INCLUDING WITHOUT LIMITATION, IMPLIED WARRANTIES OF MERCHANTABILITY AND FITNESS FOR A PARTICULAR PURPOSE, ARE LIMITED TO THE DURATION OF THIS LIMITED WARRANTY. IN NO EVENT SHALL MOTOROLA BE LIABLE FOR DAMAGES IN EXCESS OF THE PURCHASE PRICE OF THE PRODUCT, FOR ANY LOSS OF USE, LOSS OF TIME, INCONVENIENCE, COMMERCIAL LOSS, LOST PROFITS OR SAVINGS OR OTHER INCIDENTAL, SPECIAL OR CONSEQUENTIAL DAMAGES ARISING OUT OF THE USE OR INABILITY TO USE SUCH PRODUCT, TO THE FULL EXTENT SUCH MAY BE DISCLAIMED BY LAW.

III. STATE LAW RIGHTS:

SOME STATES DO NOT ALLOW THE EXCLUSION OR LIMITATION OF INCIDENTAL OR CONSEQUENTIAL DAMAGES OR LIMITATION ON HOW LONG AN IMPLIED WARRANTY LASTS, SO THE ABOVE LIMITATION OR EXCLUSIONS MAY NOT APPLY.

This warranty gives specific legal rights, and there may be other rights which may vary from state to state.

IV. HOW TO GET WARRANTY SERVICE:

You must provide proof of purchase (bearing the date of purchase and Product item serial number) in order to receive warranty service and, also, deliver or send the Product item, transportation and insurance prepaid, to an authorized warranty service location. Warranty service will be provided by MOTOROLA through one of its authorized warranty service locations. If you first contact the company which sold you the Product (e.g., dealer or communication service provider), it can facilitate your obtaining warranty service. You can also call MOTOROLA at 1-800-927-2744 US/Canada.

V. WHAT THIS WARRANTY DOES NOT COVER:

- 1 Defects or damage resulting from use of the Product in other than its normal and customary manner.
- 2 Defects or damage from misuse, accident, water, or neglect.
- 3 Defects or damage from improper testing, operation, maintenance, installation, alteration, modification, or adjustment.
- 4 Breakage or damage to antennas unless caused directly by defects in material workmanship.
- 5 A Product subjected to unauthorized Product modifications, disassembles or repairs (including, without limitation, the addition to the Product of non-MOTOROLA supplied equipment) which adversely affect performance of the Product or interfere with MOTOROLA's normal warranty inspection and testing of the Product to verify any warranty claim.
- 6 Product which has had the serial number removed or made illegible.
- 7 Rechargeable batteries if:

- 1 any of the seals on the battery enclosure of cells are broken or show evidence of tampering.
- 2 the damage or defect is caused by charging or using the battery in equipment or service other than the Product for which it is specified.
- 8 Freight costs to the repair depot.
- 9 A Product which, due to illegal or unauthorized alteration of the software/firmware in the Product, does not function in accordance with MOTOROLA's published specifications or the FCC certification labeling in effect for the Product at the time the Product was initially distributed from MOTOROLA.
- 10 Scratches or other cosmetic damage to Product surfaces that does not affect the operation of the Product.
- 11 Normal and customary wear and tear.

VI. PATENT AND SOFTWARE PROVISIONS:

MOTOROLA will defend, at its own expense, any suit brought against the end user purchaser to the extent that it is based on a claim that the Product or parts infringe a United States patent, and MOTOROLA will pay those costs and damages finally awarded against

the end user purchaser in any such suit which are attributable to any such claim, but such defense and payments are conditioned on the following:

- 1 that MOTOROLA will be notified promptly in writing by such purchaser of any notice of such claim,
- 2 that MOTOROLA will have sole control of the defense of such suit and all negotiations for its settlement or compromise, and
- 3 should the Product or parts become, or in MOTOROLA's opinion be likely to become, the subject of a claim of infringement of a United States patent, that such purchaser will permit MOTOROLA, at its option and expense, either to procure for such purchaser the right to continue using the Product or parts or to replace or modify the same so that it becomes non-infringing or to grant such purchaser a credit for the Product or parts as depreciated and accept its return. The depreciation will be an equal amount per year over the lifetime of the Product or parts as established by MOTOROLA.

MOTOROLA will have no liability with respect to any claim of patent infringement which is based upon the combination of the Product or parts furnished

hereunder with software, apparatus or devices not furnished by MOTOROLA, nor will MOTOROLA have any liability for the use of ancillary equipment or software not furnished by MOTOROLA which is attached to or used in connection with the Product. The foregoing states the entire liability of MOTOROLA with respect to infringement of patents by the Product or any parts thereof.

Laws in the United States and other countries preserve for MOTOROLA certain exclusive rights for copyrighted MOTOROLA software such as the exclusive rights to reproduce in copies and distribute copies of such MOTOROLA software. MOTOROLA software may be used in only the Product in which the software was originally embodied and such software in such Product may not be replaced, copied, distributed, modified in any way, or used to produce any derivative thereof. No other use including, without limitation, alteration, modification, reproduction, distribution, or reverse engineering of such MOTOROLA software or exercise of rights in such MOTOROLA software is permitted. No license is granted by implication, estoppel or otherwise under MOTOROLA patent rights or copyrights.

VII. GOVERNING LAW:

This Warranty is governed by the laws of the State of Illinois, U.S.A.

MOTOROLA

Recommended Dealer:
www.hkrsolutions.com

HKRSolutions
Two-way Radio & Accessories Specialist

MOTOROLA, MOTO, MOTOROLA SOLUTIONS and the Stylized M logo are trademarks or registered trademarks of Motorola Trademark Holdings, LLC and are used under license.

All other trademarks are the property of their respective owners.
© 2013 Motorola Solutions, Inc. All rights reserved.
November 2013.



68012004090-G